

REPUBLICA ORIENTAL DEL URUGUAY

MINISTERIO DE INDUSTRIA, ENERGIA Y MINERIA

DIRECCION NACIONAL DE LA PROPIEDAD INDUSTRIAL

# **BOLETIN**

**de la**

# **Propiedad Industrial**

**N° 276**

**30 de Setiembre de 2022**

*República Oriental del Uruguay*



Ministerio  
**de Industria,  
Energía y Minería**

*Dirección Nacional de la  
Propiedad Industrial*

**BOLETÍN**

**DE LA PROPIEDAD  
INDUSTRIAL**

**ISSN 2301 – 1777**  
**Impreso en D.N.P.I.**  
**Permiso N° 2160 (Biblioteca Nacional)**  
**URUGUAY**

***REPÚBLICA ORIENTAL DEL URUGUAY***



**MINISTERIO DE INDUSTRIA, ENERGÍA Y MINERÍA**

**DIRECCIÓN NACIONAL DE LA PROPIEDAD INDUSTRIAL**

**ING. OMAR PAGANINI**

MINISTRO DE INDUSTRIA, ENERGÍA Y MINERÍA

**SR. WALTER VERRI**

SUBSECRETARIO

MINISTERIO DE INDUSTRIA, ENERGÍA Y MINERÍA

**DR. JUAN PABLO BORGES**

DIRECTOR GENERAL DE SECRETARÍA

MINISTERIO DE INDUSTRIA, ENERGÍA Y MINERÍA

**DR. MARCELO CIPULLO MONTALTO**

ENCARGADO DE DESPACHO DE DIRECCIÓN NACIONAL



de acuerdo a lo establecido por los artículos 80 y 101 de la Ley  
N° 17.011 de fecha 25 de Setiembre de 1998 ésta es la  
Publicación Oficial de la Dirección Nacional de la Propiedad  
Industrial, Unidad Ejecutora del Ministerio de Industria, Energía  
y Minería, cuyo cometido sustantivo es administrar y proteger el  
derecho de la Propiedad Industrial.

RINCON 719 – Teléfono 2900 0658 – C.P. 11.000

e-mail: [secretaria.dnpi@miem.gub.uy](mailto:secretaria.dnpi@miem.gub.uy)

<http://www.miem.gub.uy>



## ***LISTADO DE CÓDIGOS UTILIZADOS EN EL BOLETÍN***

LISTA DE CÓDIGOS, POR ORDEN ALFABÉTICO, Y LOS NOMBRES CORRESPONDIENTES (ABREVIADOS) DE ESTADOS, OTRAS ENTIDADES Y ORGANIZACIONES INTERGUBERNAMENTALES.

AD	ANDORRA	CS	SERBIA Y MONTENEGRO
AE	EMIRATOS ARABES UNIDOS	CU	CUBA
AF	AFGANISTAN	CV	CABO VERDE
AG	ANTIGUA Y BARBUDA	CY	CHIPRE
AI	ANGUILLA	CZ	REPUBLICA CHECA
AL	ALBANIA		
AM	ARMENIA	DE	ALEMANIA
AN	ANTILLAS NEERLANDESAS	DJ	DJIBOUTI
AO	ANGOLA	DK	DINAMARCA
AP	ORGANIZACIÓN REGIONAL AFRICANA DE LA PROPIEDAD INDUSTRIAL (ARIPO)	DM	DOMINICA
AR	ARGENTINA	DO	REPUBLICA DOMINICANA
AT	AUSTRIA	DZ	ARGELIA
AU	AUSTRALIA	EA	ORGANIZACIÓN EUROASIÁTICA DE PATENTES (EAPO)
AW	ARUBA	EC	ECUADOR
AZ	AZERBAIYAN	EE	ESTONIA
		EG	EGIPTO
BA	BOSNIA Y HERZEGOVINA	EH	SAHARA OCCIDENTAL
BB	BARBADOS	EM	OFICINA PARA LA ARMONIZACIÓN DEL MERCADO INTERIOR (MARCAS Y DIBUJOS Y MODELOS) (OAMI)
BD	BANGLADESH	EP	OFICINA EUROPEA DE PATENTES (OEP)
BE	BELGICA	ER	ERITREA
BF	BURKINA FASO	ES	ESPAÑA
BG	BULGARIA	ET	ETIOPIA
BH	BAHREIN		
BI	BURUNDI	FI	FINLANDIA
BJ	BENIN	FJ	FIJI
BM	BERMUDA	FK	ISLAS FALKLAND (MALVINAS)
BN	BRUNEI DARUSSALAM	FO	ISLAS FEROE
BO	BOLIVIA	FR	FRANCIA
BR	BRASIL		
BS	BAHAMAS	GA	GABON
BT	BHUTAN	GB	REINO UNIDO
BV	ISLA BOUVET	GC	OFICINA DE PATENTES DEL CONSEJO DE COOPERACION DE LOS ESTADOS ARABES DEL GOLFO (CCG)
BW	BOTSWANA	GD	GRANADA
BX	OFICINA BENELUX DE MARCAS (BBM) Y OFICINA BENELUX DE DIBUJOS Y MODELOS (BBDM)	GE	GEORGIA
BY	BELARUS	GH	GHANA
BZ	BELICE	GI	GIBRALTAR
		GL	GROENLANDIA
CA	CANADA	GM	GAMBIA
CD	REPUBLICA DEMOCRATICA DEL CONGO	GN	GUINEA
CF	REPUBLICA CENTROAFRICANA	GQ	GUINEA ECUATORIAL
CG	CONGO	GR	GRECIA
CH	SUIZA	GS	ISLAS GEORGIA DEL SUR Y SANDWICH DEL SUR
CI	COTE D'IVOIRE	GT	GUATEMALA
CK	ISLAS COOK	GW	GUINEA - BISSAU
CL	CHILE	GY	GUYANA
CM	CAMERUN	HK	REGION ADMINISTRATIVA ESPECIAL DE HONG KONG DE LA REPUBLICA POPULAR DE CHINA
CN	CHINA		
CO	COLOMBIA		
CR	COSTA RICA		



HN	HONDURAS	MZ	MOZAMBIQUE
HR	CROACIA	NA	NAMIBIA
HT	HAITI	NE	NIGER
HU	HUNGRIA	NG	NIGERIA
IB	OFICINA INTERNACIONAL DE LA ORGANIZACIÓN MUNDIAL DE LA PROPIEDAD INTELECTUAL (OMPI)	NI	NICARAGUA
ID	INDONESIA	NL	PAISES BAJOS
IE	IRLANDA	NO	NORUEGA
IM	ISLA DE MAN	NP	NEPAL
IL	ISRAEL	NR	NAURU
IN	INDIA	NZ	NUEVA ZELANDIA
IQ	IRAQ	OA	ORGANIZACION AFRICANA DE LA PROPIEDAD INTELECTUAL (OAPI)
IR	IRAN(REPUBLICA ISLAMICA DEL)	OM	OMAN
IS	ISLANDIA	PA	PANAMA
IT	ITALIA	PE	PERU
JM	JAMAICA	PG	PAPUA NUEVA GUINEA
JO	JORDANIA	PH	FILIPINAS
JP	JAPON	PK	PAKISTAN
KE	KENYA	PL	POLONIA
KG	KIRGUISTAN	PT	PORTUGAL
KH	CAMBOYA	PW	PALAU
KI	KIRIBATI	PY	PARAGUAY
KM	COMORAS	QA	QATAR
KN	SAINT KITTS Y NEVIS	RO	RUMANIA
KP	REPUBLICA POPULAR DEMOCRATICA DE COREA	RS	SERBIA
KR	REPUBLICA DE COREA	RU	FEDERACION DE RUSIA
KW	KUWAIT	RW	RWANDA
KY	ISLAS CAIMAN	SA	ARABIA SAUDITA
KZ	KAZAKSTAN	SB	ISLAS SALOMON
LA	REPUBLICA DEMOCRATICA POPULAR LAO	SC	SEYCHELLES
LB	LIBANO	SD	SUDAN
LC	SANTA LUCIA	SE	SUECIA
LI	LIECHTENSTEIN	SG	SINGAPUR
LK	SRI LANKA	SH	SANTA HELENA
LR	LIBERIA	SI	ESLOVENIA
LS	LESOTHO	SK	ESLOVAQUIA
LT	LITUANIA	SL	SIERRA LEONA
LU	LUXEMBURGO	SM	SAN MARINO
LV	LETONIA	SN	SENEGAL
LY	JAMAHIRIYA ARABE LIBIA	SO	SOMALIA
MA	MARRUECOS	SR	SURINAME
MC	MONACO	ST	SANTO TOME Y PRINCIPE
MD	REPUBLICA DE MOLDOVA	SV	EL SALVADOR
ME	MONTENEGRO	SY	REPUBLICA ARABE SIRIA
MG	MADAGASCAR	SZ	SWAZILANDIA
MK	EX REPUBLICA YUGOSLAVA DE MACEDONIA	TC	ISLAS TURCOS Y CAICOS
ML	MALI	TD	CHAD
MM	MYANMAR	TG	TOGO
MN	MONGOLIA	TH	TAILANDIA
MO	MACAO	TJ	TAYIKISTAN
MP	ISLAS MARIANAS SEPTENTRIONALES	TM	TURKMENISTAN
MR	MAURITANIA	TN	TUNEZ
MS	MONTSERRAT	TO	TONGA
MT	MALTA	TP	TIMOR ORIENTAL
MU	MAURICIO	TR	TURQUIA
MV	MALDIVAS	TT	TRINIDAD Y TOBAGO
MW	MALAWI	TV	TUVALU
MX	MEXICO		
MY	MALASIA		

---

TW	TAIWAN, PROVINCIA DE CHINA	VN	VIET NAM
TZ	REPUBLICA UNIDA DE TANZANIA	VU	VANUATU
UA	UCRANIA	WO	ORGANIZACIÓN MUNDIAL DE LA PROPIEDAD INTELLECTUAL (OMPI) (OFICINA INTERNACIONAL DE)
UG	UGANDA	WS	SAMOA
US	ESTADOS UNIDOS DE AMERICA	YE	YEMEN
UY	URUGUAY	ZA	SUDAFRICA
UZ	UZBEKISTAN	ZM	ZAMBIA
VA	SANTA SEDE	ZW	ZIMBABWE
VC	SAN VICENTE Y LAS GRANADINAS		
VE	VENEZUELA		
VG	ISLAS VIRGENES (BRITANICAS)		

### MARCAS (Norma OMPI St. 60)

- (210) – Número de Solicitud.
- (730) – Nombre y dirección del solicitante o titular del Registro.
- (220) – Fecha de presentación de la solicitud.
- (511) – Clase y/o Producto o Servicio protegido (Clasificación de Niza) (Novena Edición).
- (540) – Reproducción de la Marca.
- (300) – Datos relativos a la prioridad en virtud del Convenio de la Unión de París (Número asignado a la primera solicitud, fecha de presentación de la primera solicitud, código de la Norma Ompi St 3 de la Oficina nacional o regional donde se presentó la primera solicitud).
  
- (591) – Información relativa a los colores reivindicados.
- (551) – Indicación de que la marca es una marca colectiva o una marca de certificación o garantía.
- (554) – Marca tridimensional.
- (556) – Marca sonora, incluidas las características.
- (740) - Datos del Agente de la Propiedad Industrial.

## PATENTES Y MODELOS DE UTILIDAD (Norma OMPI St. 9)

- (21) - Número de la solicitud de Invención o Modelo de Utilidad.
- (22) - Fecha de presentación de la solicitud.
- (12) - Designación del tipo de documento.
- (71) - Datos del solicitante, incluyendo nombre y país de origen.
- (72) - Nombre del Inventor/es.
- (51) - Clasificación Internacional de Patentes (Clasificación de Estrasburgo) (Sexta Edición).
- (54) - Título de la Invención.
- (57) - Resumen y diseño de la invención o descripción del modelo de utilidad o diseño (no más de 100 palabras).
- (74) - Nombre del Agente de la Propiedad Industrial.
- (30) - Datos relativos a la prioridad en virtud del Convenio de la Unión de París.
- (31) - Número asignado a la solicitud prioritaria o reválida.
- (32) - Fecha de depósito de la solicitud prioritaria.
- (33) - Código de la Norma St. 3 de Ompi que identifica a la Oficina de Propiedad Industrial que ha atribuido el número a la solicitud prioritaria o de la Organización que ha atribuido el número de la solicitud regional prioritaria ( para las solicitudes internacionales registradas en virtud del PCT, debe utilizarse el Código "WO").

A continuación del número de la solicitud correspondiente (Código 21), deberá aplicarse el código normalizado para la identificación de los diferentes tipos de documentos de patentes (Norma Ompi St. 16):

A1: Invención Primaria

U: Modelo de Utilidad

## DISEÑOS Y MODELOS INDUSTRIALES (Norma OMPI St. 80)

- (21) - Número de la solicitud del diseño o modelo industrial.
- (22) - Fecha de presentación de la solicitud.
- (12) - Designación del tipo de documento.
- (71) - Datos del solicitante, incluyendo nombre y país de origen.
- (72) - Nombre del creador/es.
- (51) - Clasificación Internacional para los Dibujos y Modelos Industriales (Clasificación de Locarno) (Sexta Edición).
- (54) - Título del Diseño o Modelo.
- (57) - Resumen y descripción del diseño o modelo industrial incluidas las indicaciones de colores (no más de 100 palabras).
- (74) - Nombre del Agente de la Propiedad Industrial.
- (30) - Datos relativos a la prioridad en virtud del Convenio de la Unión de París.
- (31) - Número asignado a la solicitud prioritaria o reválida.
- (32) - Fecha de depósito de la solicitud prioritaria.
- (33) - Código de la Norma St. 3 de Ompi identificando a la Oficina nacional o regional u organización en la que se presentó la solicitud prioritaria (para los depósitos internacionales presentados en virtud del Arreglo de La Haya, se debe utilizar el Código "WO"). A continuación del número de la solicitud correspondiente (Código 21) deberá aplicarse el código normalizado para la identificación de los diferentes tipos de documentos (Norma OMPI St. 17):

Q: Diseños y Modelos Industriales

*Listado de Agentes de la Propiedad Industrial*

<b>Nro</b>	<b>Nombre</b>	<b>Dirección</b>	<b>CP</b>	<b>Teléfono</b>	<b>Fax</b>	<b>E-mail</b>
3	CIKATO LAY, MANFREDO ANDRES	Araucana 1277	11400	2606.06.06	2606.14.39	cikato@cikato.com.uy
6	MARINARI SEXTO, WALTER HUGO	25 de Mayo 576	11000	2916.34.55	2916.21.93	bacot@bacot.com.uy
8	ARROLI TELESKA, RUBEN JOSE	Ituzaingó 1485 esc.12	11000	2915.94.75		
12	FREIRA SERRAT, CARLOS MARIA	Río Negro 1394 piso 10 esc.10	11100	2901.16.70/ 2901.58.32		
15	DAIQUI BALMACEDA, JUAN CARLOS	Río Negro 1394 piso 10 esc.10	11100			
16	GIMENEZ SORHUET, ROBERTO DARIO	Florida 1485 ap.301	11000	2901.22.78		
17	PONCE DE LEON MURO, JULIO CESAR	Florida 1485 ap.301	11000	2901.22.78		
18	BACOT SILVEIRA, OSCAR TULIO	25 de Mayo 576	11000	2916.34.69	2916.21.93	obacot@bacot.com.uy
19	FREIRA SERRAT, JUAN MIGUEL	Plaza Cagancha 1335 esc. 317/18	11100	2900.06.86	2908.71.27	jmfreira@adinet.com.uy
20	FOX TAYLOR, NORMAN ALEXANDER	Pedro Murillo 6136	11500	2604.03.60	2604.66.69	nfox@fox.com.uy
21	LAMAS BALESTRA, MARIO DANIEL	Lucerna 6273	11400	2600.37.67		dlamas@lamasgrimaldi.com.uy
23	BONADA ASUAGA, ROBERTO GUZMAN	Lancasteriana 2359 bis	11400	2600.72.24		
24	LANZON MAZZELLO, RAFAEL EDUARDO	Brandzen 1961 esc.102	11200	2408.50.38	2409.97.61	rlanzon@lanz.com.uy
25	PIÑEYRO CAMACHO, MARTHA NELIDA	Plaza Independencia 848 1er. Piso	11000	2908.81.36		mpineyro@montevideo.com.uy
26	VECINO SANCHEZ, GERMAN	Mones Roses 6937	11500	2604.16.04	2604.66.04	gvecino@ppv.com.uy
28	MEDINA YLLA, EDUARDO JOSE	Av. Garibaldi 2185		2203.93.06/ 2209.51.40	2200.74.74	info@medinamarcas.com
29	PITTALUGA SHAW, JUAN ANTONIO	Echevarriarza 3535 Of. 1601 Torre A	11300	2623.29.59	2623.29.57	juan@pittaluga.com
30	MAESO VALINO, MARIA CRISTINA	Colonia 1825 apto.402				
31	PILAS SEMICHEVICH, RODOLFO	Av. Uruguay 2049 bis	11100	2409.36.02	2401.55.72	uruguay@pilasnet.com.uy

Nro	Nombre	Dirección	CP	Teléfono	Fax	E-mail
32	MELGAR PEREZ, ASTUR EULOGIO	Av. Uruguay 1826	11100	2409.17.00	2402.30.55	
34	FERNANDEZ SECCO, GONZALO JOSE	25 de Mayo 467 piso 5	11000	2916.19.13	2916.57.40	gonzalo@fernandezsecco.com.uy
35	D' ALESSANDRO VALIDO, JULIO CESAR	Juan Paullier 2015	11200	2400.39.70		
37	FERNANDEZ PEREZ, EDUARDO LUIS	Fernández Crespo 1861 bis	11200	2400.22.90	2400.22.90	eduardoluisf@gmail.com
38	BOGNANNO PAULOS, NOEMI CLARA	Rincón 682 esc.14	11000	2916.38.72		
39	CROCCO MARTINEZ, ALVARO HARRIET	Av. Garibaldi 2276		2200.74.24		
40	MORGADE DI POLITO, CLAUDIO	Av. de las Américas 8336, Block 1, Ap.101	15000	094.429.107		cmorgade@morgade.uy
41	DELPIAZZO RODRIGUEZ, CARLOS ENRIQUE	Misiones 1424 piso 5	11000	2915.30.30	2915.30.30 int. 512	delpiazzo@delpiazzo.com.uy
42	ARGENTINO DE BELLO, ROSARIO NELLY	Juncal 1431 esc. 402	11000	-		
43	AURUCCI DE MORALES, SYLVIA RITA	25 de Mayo 395 piso 3 apto.6	11000	-		
44	SAAVEDRA LEVRATTO, LORENZO	Zapicán 2980-82		2209.46.83		
45	DOCAMPO EIRIN, ALBERTO MARIO	Rivera 6056		2600.39.41		
46	EIRIN DI FAZIO, ALVARO JORGE	Plaza Independencia 831 esc. 609	11300	2902.75.49	2902.35.51	
47	PISANI PALMER, CARLOS ORLANDO	R. Hayadelat 1688		2619.63.77		
48	MONTANO GOMEZ, PEDRO JULIO	Plaza Cagancha 1335 ap. 1104	11100	2903.07.80	2903.07.80 int. 211	sym@scelzaymontano.com.uy
49	ORDOQUI CASTILLA, GUSTAVO ANTONIO	Rincón 728	11000	2708.38.03		gustavo@ordoquicastilla.com
50	CORTI ACOSTA, GRACIELA BEATRIZ	Obligado 1070	11300	2709.30.95		gcorti@adinet.com.uy
51	SCELZA MARTINEZ, FERNANDO LUIS	Rba. Rep. del Perú 1043	11300	2708.29.50		
52	PRAT GUTIERREZ, AGUSTIN JULIO	Palacio Lapido Av. 18 de julio 948 ap.401	11100	29047739		pratasoc@usa.net
53	APEZECHEA SANTINI, JOSE ANTONIO	Colonia 2108 apto.701	11200	2408.43.08		
54	NAVARRO CASTEX, ALEJANDRO	Pza. Independencia 1374	11100	2902.42.16		

Nro	Nombre	Dirección	CP	Teléfono	Fax	E-mail
	MARIANO					
55	RODRIGUEZ TURRINA, LUIS ALBERTO	Río Negro 1380	11100	2908.50.62		
56	CAGNOLA MERCADAL, CARLOS	La Paz 1988		2400.56.95		
57	IRIGOYEN DESCALZI, JOSE MARTÍN	25 de Mayo 635 esc. 203	11000	2916.03.37		
58	SANJINES RAVIZZA, CRISTOBAL ERNESTO	Duvimioso Terra 2327 apto. 6	11200	-		
59	MUSSIO TORRES, DIEGO EDUARDO	J.M.Blanes 869	11200	2413.65.67		
61	BALLIVA GIMENEZ, WASHINGTON ULISES	Rincón 540 piso 7	11000	-		
62	ZARUCKI ABRAMODICAS, JAIME	Bulevar Artigas 515 apto. 301	11300	-		
63	POPLAWSKI NATANSON, LIZABETH	Maldonado 2422 apto. 21	11200	-		
64	GAMUNDI DEMARCO, GERARDO ANIBAL	José Benito Lamas 2792	11300	-		
65	MARTINEZ LEONI, JOSE LUIS	Brandzen 1961 esc.602	11200	2407.81.72	2407.81.75	jose@martinezleoni.com.uy
66	DE POSADAS MONTERO, DIEGO ANTONIO	Rincón 454 esc. 316	11000	-		
67	MAYER MARTINEZ, FEDERICO OSCAR	Ituzaingó 1393 esc. 503	11000	-		
68	MOREIRA PIEGAS, ROBERTO	Colonia 981 esc. 604	11100	2900.34.71	2900.86.22	moreirap@adinet.com.uy
69	FONT BERTINAT, BISMARCK ENRIQUE	Av. Uruguay 872	11100	2902.55.65/ 2902.55.67		
70	ZAS FERNANDEZ, JORGE	Ejido 1425 esc. 3	11100	-		
71	LAURNAGA MARANA, VICTORIO JORGE	Bulevar España 2575 apto. 302	11300	-		
72	COSTA ALBERTONI, NEDER ERNESTO	25 de mayo 477 esc. 28	11000	-		
74	LAMAS MORENO, LUIS FLORENCIO	Ramón Massini 3304 apto. 403	11300	2708.47.61		
75	CHIARINO MAÑE, ARMANDO	García de Zúñiga 2265	11300	2711.07.77		
76	SUAREZ ANTOLA, GRISELDA	18 de Julio 1805		2409.26.80		

Nro	Nombre	Dirección	CP	Teléfono	Fax	E-mail
77	STRAPETTI MONTESANO, HUGO	Av. Agraciada 2955 apto.106		-		
78	FERNANDEZ GOYECHEA, LUIS ENRIQUE	25 de Mayo 467 piso 4 esc. 7	11000	-		
79	MACIEL PAPP, GUILLERMO HORACIO	Santiago Vázquez 1244 of. 502	11300	2916.34.55		
80	STEFANOLI PESCKETTO, ALEJANDRO	Juan Benito Blanco 1127 apto. 101	11300	2709.04.45		
81	FLORES CASTRO, GALA DEL CARMEN	Bulevar Artigas 3942 apto. 1		-		
82	HERVI BARROS, CARLOS ROGELIO	Dalmiro Costa 4486 apto. 2	11400	2619.55.94		
83	D' ALBORA SOLARI, FELIPE CONRADO	Dr. Francisco Soca 1360	11300	2708.11.20		
84	STEFANOLI PESCKETTO, MARIO FIDEL	Andes 1111	11100	2908.59.38		
85	FIGUEREDO MARTINEZ, OSCAR MARIO	25 de Mayo 477 esc. 50	11000	-		
86	INVIDIO MAURIELLO, SANTIAGO RODOLFO	25 de Mayo 661 esc. 205	11000	-		
87	ORLANDO SANTA MARIA, MARIA LORELEY	Juan Paullier 2416	11200	-		
89	FERRAZ MADRID, JOSE PEDRO	Juncal 1408 piso 5 esc. 9	11000	-		
90	ENRIQUEZ FIGOLI, JORGE RUBEN	Misiones 1371 piso 1 esc. 8	11000	-		
92	MENDEZ MANOVSKY, RUPERTO ALVARO	Tacuarembó 1442	11200	2402.90.96		
93	CANTON POMBO, MARCELO	Treinta y Tres 1420 piso 2 esc.15	11000	2916.52.25		
94	FISCHER FLEURQUIN, GUSTAVO RODOLFO	San José 807 Of. 403	11100	2908.71.67	2908.35.58	fischer@fischer.com.uy
95	VIANA FERREIRA, ENRIQUE ALIPIO	Av. Uruguay 1824 apto. 202	11200	-		
96	MONTORO HEGUERTE, FRANCISCO EDISON	Treinta y Tres 1374 esc.108	11000	2915.94.27		
97	FINALI PILAS, MIRYAM ROSSANA	Av. Uruguay 2049	11100	2409.36.02	2401.55.72	uruguay@pilasnet.com.uy
98	VILLAGRAN MERA, CLAUDIA	Juncal 1398 piso 4 esc.4/40	11000	-		

Nro	Nombre	Dirección	CP	Teléfono	Fax	E-mail
99	HENDLER TRIADOR, GABRIELA	Juncal 1395 esc.42	11000	-		
101	MARTINONI OTORMIN, GUSTAVO EDUARDO	Av. Brasil 2986 Of. 409, Torre Parque Sabato	11300	2707.75.18	2707.56.46	gustavomartinoni@martinoniyrodriguez.com
103	ABENTE LE BAS, DIEGO MONTGOMERY	Araucana 1277	11400	2606.06.06	2606.14.39	cikato@cikato.com.uy
104	PILAS PEREIRA, RODOLFO	Av. Uruguay 2049	11100	2409.36.02	2401.55.72	uruguay@pilas.com.uy
105	GERONA COSIO, HECTOR RICARDO	Colonia 815 esc. 504	11100	2901.36.08	2901.36.08	
106	GAMIO CIA, JUAN ENRIQUE	Misiones 1379 esc. 601	11000	-		
107	GUTIERREZ CARRAU, JUAN MANUEL	Rincón 528 Piso 6	11000	2916.50.94/ 2916.50.95	2916.13.59	
108	SILVA LEDESMA TERRA, JULIO CESAR	Rincón y 25 de Mayo, Ed.Rafael apto. 902, Maldonado				
109	PLA REGULES, MARIA MARTA	Cerrito 420 esc. 404	11000	2915.66.20		
110	AMOZA ANTUNEZ DE OLIVERA, EDGARDO	Juncal 1305 piso 2 esc. 206	11000	2916.43.66		
111	MINICELLI D'AMATO, NELSON DANIEL	Alfredo Baldomir 2363 apto.202	11300	-		
112	GUTIERREZ GALIANA, JORGE	Río Branco 1359 apto.903	11000	2901.78.34		
113	MOREIRA BIRRIEL, MARIA GRACIELA	Río Branco 1359 apto.903	11100	2901.78.34		
114	GENTA FONS, PABLO	Cnel. Brandzen 1961 of. 1004	11200	2409.24.21/ 2402.79.39	2408.77.26	gentafons@fastlink.com.uy
115	CARNELLI DI LEONE, CARLOS RAFAEL	Coronel Alegre 1321 piso 4	11300	2709.94.29		
116	IRIBARNE AGUINSKY, NORA	Bulevar España 2166 apto.302	11300	-		
117	GARCIA VILA, MARIO DANIEL	Maggiolo 685	11300	2711.57.41		
118	MARTINEZ VIVAS, MARIA INES	Reconquista 517 piso 6	11000	2917.01.87	2916.34.05	minesm@adinet.com.uy
119	GIAMBRUNO MAROÑO, MARIA INES	25 de Mayo 467 piso 5	11000	2916.19.13	2916.57.40	mgiambruno@fernandezsecco.com



Nro	Nombre	Dirección	CP	Teléfono	Fax	E-mail
120	PONZONI GARCIA, JOSE LUIS	Juncal 1431 esc.702	11000	2915.82.11		
121	GUADALUPE BRENNNA, DIEGO	Ellauri 896 apto.101	11300	-		
122	VENCE CASSINA, TERESITA ANDREA	Hernandarias 3623	11400	2507.77.64		
123	CASTELLS BARTHABURU, MARÍA DE LAS MERCEDES	San José 807 esc. 403	11100	2908.71.67	2908.35.58	fischer@fischer.com.uy
124	CHARLONE SPINNELLI, BENJAMIN DANIEL	Brandzen 1961 esc.502	11200	-		
125	IGLESIAS HERRERO, LUIS FERNANDO	Zabala 1394 bis piso 1	11000			luisf.iglesias@gmail.com
126	ARIAS DURAN, JORGE ALFREDO	Ituzaingó 1312 apto.205	11000	2915.91.41/ 2915.89.08	2916.42.56	ariasjalf@yahoo.com
127	STIGLITZ HOLZMAN, BERNARDO MENDEL	18 de julio 1516 apto.2		-		
128	DURAN RAMALLO, JORGE HORACIO	San José 871	11100	-		
129	STEZANO MARIÑO, ANA MARIA	Convención 1307 Of.502	11100	2902.21.98	2902. 66.53/ 095314299	anamaria@stezano.com
130	GUICHON SILVA, JOSE LUIS	Pza.Cagancha 1335 esc. 206	11100	2902.31.18/ 2902.16.55	2902.13.44	jones@jones.com.uy
131	STUCZYNSKI SLONIMSKY, GERARDO DAVID	Charrúa 2665		-		
132	ESPALTER MASOLLER, HAROLDO JOSE	Dr. Elazarola 2319	11400	2600.02.07		
133	HUGHES PORRAS, MARIA MARIELA	25 de mayo 455 piso 4	11000	2915.56.83		
134	RISSO SHIEN, LAURA LUCIA	Río Negro 1354 apto.14	11100			
135	BACOT SILVEIRA, MONICA SUSANA	Av. 18 de Julio 841, piso 4 / 402		2903.20.47/ 2900.41.02	2903.21.03	monicabacot@mbs.com.uy
136	DEL CERRO ROLDOS, SUSANA VERÓNICA	Echevarriarza 3535 Of. 1601 Torre A	11300	2623.29.59	2623.29.57	sdelcerro@pittaluga.com
138	RODRIGUEZ VILLAMIL RIVIERE, RAMIRO	Máximo Tajés 6482	11400	2600.59.81		

Nro	Nombre	Dirección	CP	Teléfono	Fax	E-mail
140	LAPENNE IMAZ, EDUARDO MARCELO	Pedro Murillo 6136	11500	2604.03.60	2604.66.69	fox@fox.com.uy
141	TERRA ORTIZ DE TARANCO, ANA INÉS	Plaza Independencia 831 Of. 507	11000	2908.86.38	2908.86.40	bacot@bacot.com.uy
142	LARREA CASTRO, MAGELA ADRIANA	J.C.Gomez 1479	11100	2915.99.48		
143	SANTUCCI SCARLATO, ANA MARIA	Araucana 1312	11400	2600.21.03		
144	VANRELL FALCON, JUAN EDUARDO	Prof. J. C. Sabat Pebet 1230 Of. 508	11300	2628.60.33	2622.53.55	juanvanrell@vanrell.com.uy
145	LOPEZ OTTE, MARIO ANDRES	Araucana 1277	11400	2606.06.06	2606.14.39	cikato@cikato.com.uy
146	CAMPOS BARNECH, ENRIQUE FERNANDO	Paraguay 1196 esc. 002	11200	2901.46.44	2901.46.44	camposbarnech@hotmail.com
147	SCHULKIN GURMAN, AUGUSTO FERNANDO	Bulevar España 2293	11200	2401.09.94		
148	GARCIA GONZALEZ, SYLVIA ESTELA	Pablo Podestá 1293		-		
149	FERNANDEZ IRUJO, MARIA BEATRIZ	Pablo Pérez 4523		2215.11.32		
150	BAZZI GALLI, CARINNA GLORIA	Mercedes 1787		2400.91.36	2408.57.21	cbazzi@ertec.com.uy
151	GONZALEZ PITA, MARCELO JOSE	Pagola 3261 apto.104	11300	2709.25.65		
152	GIAMBRUNO MAROÑO, GABRIEL GERARDO	25 de Mayo 467 of. 401	11000	2916.19.13 AL 15	2916.57.40	fersecco@adinet.com.uy
153	TONARELLI DE PENA, MARIA NOEL	25 de mayo 587 apto.101	11000	2916.54.92		
154	SCIARRA CAUBARRERE, ALEJANDRO	Rincón 531, Oficina 202		2916.66.45		sciarra@sciarra.com.uy
155	SCIARRA CAUBARRERE, ADRIANA	Lido 1621	11400	2604.38.59		
156	TEUTEN BROOKER, MARK CHRISTOPHER	WTC Torre III, Luis A. De Herrera 1248 Piso 15	11000	2908.86.38	2908.86.40	mteuten@cmlawyers.com.uy
157	ALVAREZ PERSICO, CARLOS	Pza. Cagancha 1335 esc. 206	11100	2902.31.18/ 2902.16.55	2902.13.44	jones@jones.com.uy
158	SUR BRAND, JORGE	Rambla República del Perú 851 ap.301	11300	2710.84.92		

Nro	Nombre	Dirección	CP	Teléfono	Fax	E-mail
159	ETCHEVERRY REYES, AGUSTIN	Cerrito 507 piso 5	11000	-		
160	SALAVERRY GALBARINI, LUCIA	Juan Carlos Gomez 1479 Esc 309	11000	2914.63.68	099611553	luciasalaverry@yahoo.com
161	STERENSTEIN PESQUERA, FERNANDO	Aurora 362		2309.35.86		
162	PEREYRA LETTIER, ROBERTO ELBIO	Vicente Yañez Pinzón 4743		2308.25.09		
163	LARMINY LOPEZ, EDGARDO	Juan Proudfoot 1764	12400	2321.18.57		elarminy@vera.com.uy
164	PEREIRA SARALEGUI, TORIBIO AMALIO	Rincón 528 piso 6	11000	2916.50.94/95	2916.13.59	tpereira@barbosa.com.uy
165	MORGADE DI POLITO, NORA	Rincón 528 piso 6	11000	2916.50.94/95	2916.13.59	barbosa@barbosa.com.uy
166	PASTORINO LEPRA, CARLOS AMERICO	Feliciano Rodríguez 2709	11300	2709.04.12		
167	GALANTE ALVAREZ, DIEGO	Bulevar Artigas 1154	11300	2708.71.72	2708.71.72	info@galantemartins.com
168	CASULO BERNASCONI, EDISON HUMBERTO	José María Montero 2770	11308	099.612341	099.612341	info@legaluy.com
169	DETJEN ETCHEVERRIGARAY, XIMENA MARIA	Colonia 1561 apto. 201		2400.32.97		
170	BERRETA NOBOA, ALVARO RAFAEL	Av. Rivera 6606	11500	2600.82.41		
171	MARTINEZ GARCIA, MARIA CECILIA	J. Zavala Muniz 5556		2601.84.78	2601.84.78	reherma@adinet.com.uy
172	DE FREITAS STRAUMANN, EDUARDO	Andes 1418 apto. 201	11100	29011191/ 2902.53.03		
173	ELUTCHANZ GRAZIANO, NATALI CRISTINA	Maldonado 1378 apto.501		-		
174	CHALKLING MAJO, ANA CAROLINA	Luis B. Cavia 3071 Of. 904	11300	2708.40.13	2708.40.13	cchalkling@estudiochalkling.com
175	RUIZ ABOU-NIGM, VERONICA	Juncal 1327 esc. 2001	11000	2915.50.01	2915.43.75	marcas@ppv.com.uy
176	NOCETTI HERRERA, ANA AMELIA	Juncal 1392	11300	2900.10.00	2623.29.57	anocetti@ferrere.com
177	DEFFEMINIS PAIVA, JUAN BAUTISTA	Mones Roses 6937	11500	2604.16.04	2604.66.04	jdeffeminis@ppv.com.uy
178	LUSSICH, ALICIA	Yamandú Rodríguez 79 (Parque de Miramar) Canelones				

Nro	Nombre	Dirección	CP	Teléfono	Fax	E-mail
179	LARROSA DE BRUN, GUSTAVO	Calle Indiana s/n, M30 S2 (Médanos de Solymar) Canelones		098.03.91.70		gustavo@larrosaip.com.uy
180	CIKATO ABENTE, ANDRES	Araucana 1277	11400	2606.06.06	2606.14.39	cikato@cikato.com.uy
181	PITTALUGA PEREIRA, JUAN MARTIN	Echevarriarza 3535 Of. 1601 Torre A	11300	2623.29.59	2623.29.57	martin@pittaluga.com
182	BAZZANO OEHLER, VERONICA MARIA	Buenos Aires 618 piso 3	11100	2917.03.60	2916.09.92	fox@fox.com.uy
183	BUGALLO MONTAÑO, NYDIA BEATRIZ	Jaime Zudañez 2628 apto. 101	11300	2710.75.66		
184	ZERBINO STAJANO, RAFAEL AUGUSTO	Treinta y Tres 1271	11000	2916.03.10	2915.56.69	rzerbino@bkzr.com
185	CREMONESE MORETTO, CARMEN RAQUEL	Misiones 1475 esc. 202	11100	-		
186	CEA BACOT, MARÍA FERNANDA	Costa Rica 2003	11500	094.26.55.62		mceabacot@gmail.com
187	CESTAU FERNÁNDEZ, GRACIELA JOSEFINA	Pedro Murillo 6136	11500	2604.03.60		gcestau@fox.com.uy
188	ALZUGARAY GONZALEZ, ALICIA GOYA	Av. Pedro Blanes Viale 5919		2606.15.38		estudio@aya.com.uy
189	SARLABÓS BUZÓ, CARLOS EDUARDO	Brandzen 1961 Of. 205	11200	094383200 092073674		info@mercomark.com.uy
190	BARREIRO RIUS, MARÍA JACQUELINE	Misiones 1371 Esc. 31	11100	2915.17.34	2916.27.55	jbarreiro@lvm.com.uy
191	ESTEVEZ GOMEZ, HUGO WASHINGTON	WTC Torre III, Luis A. De Herrera 1248 Piso 15	11300	2622.99.90		hesteves@cmlawyers.com.uy
192	DUFRECHU RODRIGUEZ, DIEGO	Plaza Cagancha 1335 Of. 206	11100	2902.31.18/ 2902.16.55	2902.13.44	DDufrechu@jones.com.uy
193	SILVA ELIZALDE, ANA VICTORIA	Av. 18 de Julio 856 piso 5		2902.31.35		
194	FOX PEREYRA, VICTORIA HELENA	Pedro Murillo 6136	11500	2604.03.60	2604.66.69	vfox@fox.com.uy
195	BENTANCOR BENTANCOR, MARÍA CECILIA	Tomás Gomensoro 2984		2481.98.41	2481.98.41	cbentan@hotmail.com
196	FERNANDEZ BALLESTEROS, CARLOS ALBERTO	Piedras 509		2915.05.76		info@osfb.com.uy

Nro	Nombre	Dirección	CP	Teléfono	Fax	E-mail
197	SALGADO CARDOZO, VIVIAN DANIELA	Ramos 4234				
198	ROMANG COLOMINAS, CATHERINE	Misiones 1424 piso 2		2916.58.59	2916.58.63	cromang@olivera.com.uy
199	CHALAR SANZ, LAURA LUCIA	Misiones 1424 piso 2		2916.58.59	2916.58.63	lchalar@olidelp.com
200	STEINER DONNANGELO, ALMA	Colonia 810 esc. 703	11100	2900.97.30	2900.97.30	asteiner@als-abogados.com.uy
201	CIKATO ABENTE, MATIAS	Araucana 1277	11400	2606.06.06	2606.14.39	cikato@cikato.com.uy
202	PALADINO TURRA, NATALIA	WTC Torre III, Luis A. De Herrera 1248 Piso 15	11300	2622.99.90		npaladino@cmlawyers.com.uy
203	MATEOS TUCUNA, FABIANA	Prof. J. C. Sabat Pebet 1230 Of. 508	11300	2628.60.33	2622.53.55	fabianamateos@vanrell.com.uy
204	VANRELL FALCÓN, VERÓNICA LOURDES	Prof. J. C. Sabat Pebet 1230 Of. 508	11300	2628.60.33	2622.53.55	veronicavanrell@vanrell.com.uy
205	MAYER WEST, AGUSTÍN	Juncal 1392	11000	2900.10.00		amayer@ferrere.com
206	MATTSSON MOELLER, SIGRID ANNITA					mattrod@adinet.com.uy
207	FERNANDEZ REQUENA, ISABEL	25 de Mayo 467 piso 5	11000	2916.19.13	2916.57.40	ifernandez@fernandezsecco.com
208	PEREIRA, LEONARDO APARICIO	Arturo Santana 811, Esc. 002, Maldonado		4223.53.44 4224.43.57	4224.88.97	lapestudio@gmail.com
209	VALLEJO ESPÍÑEIRA, CECILIA MARIA	Andes 1293 esc. 501		2292.28.69		cvallejo@ciappesoni.com
210	LAPENNE DE SALTERAIN, MARCOS	Pedro Murillo 6136	11500	2604.03.60	2604.66.69	mlapenne@fox.com.uy
211	LAPENNE DE SALTERAIN, JUAN	Pedro Murillo 6136	11500	2604.03.60	2604.66.69	jlapenne@fox.com.uy
212	CERVIERI GHIOLDI, VIRGINIA	WTC Torre III, Luis A. De Herrera 1248 Piso 15	11300	2622.99.90		cervierimonsuarez@cmlawyers.com.uy
213	FERNÁNDEZ GIAMBRUNO, AGUSTINA MARÍA	25 de Mayo 467 piso 5	11000	2916.19.13	2916.57.40	afernandez@fernandezsecco.com
214	ACHARD SANCHEZ, JORGE LUIS	WTC Torre III, Luis A. De Herrera 1248 Piso 15				
215	ACOSTA PÉREZ, MARTÍN SEBASTIÁN	Soriano 895 Ap. 304				
216	PENADÉS GRAJALES, FABIANA	Juncal 1355 of. 1101	11000	2916.65.68	2915.36.44	fpenades@clarkemodet.com.uy

Nro	Nombre	Dirección	CP	Teléfono	Fax	E-mail
	VERÓNICA					
217	BENITEZ ALVEZ, CARLOS EDGARDO	Prof. J. C. Sabat Pebet 1230 Of. 508	11300	2628.60.33	2622.53.55	carlosbenitez@vanrell.com.uy
218	WENG POLICICCHIO, STELLA MARINA	Juncal 1392	11000	2900.10.00		sweng@ferrere.com
219	CAMACHO CABRERA, MARITZA	Emilio Frugoni 886 apto. 401		24119600		aycmarcas@gmail.com
220	GALLO DUBOURG, ANDRÉS	Roque Graseras 661	11300	2716.77.69		info@mdubourg.com
221	ALTERWAIN BRUCK, ALEJANDRO	Juncal 1392	11000	2900.10.00		aalterwain@ferrere.com
222	ANTÚNEZ SEVESO, MÓNICA ANDREA	Avda. Giannatasio M10 S4, Local 7, Shangrilá, Ciudad de la Costa, Canelones				
223	ARAÚJO PERDOMO, XIMENA	Obligado 1208/102				
224	GOMENSORO VIDAL, NATALIA	Rincón 528 piso 6	11000	2916.50.94/95	2916.13.59	ngomensoro@barbosa.com.uy
225	IDOYAGA BARRO, ADOLFO MARIO	José Ellauri 7090/401				
226	GARIN da SILVA, DENIS FABIAN	Avenida Capitán Leal 5409				
227	BEZÓN RODRIGUEZ, STELLA MARIS	Durán 2131 ap. 104				
228	LANZON SEGOVIA, RAFAEL	Brandzen 1961, Piso 1 Esc.102	11200	2408.50.38	2409.97.61	rafael@lanzon.com.uy
229	AMORÍN DEL CAMPO, BERNARDO JULIO					bamorin@amorinabogados.com
230	FISCHER CASTELLS, FEDERICO GUILLERMO	Liorna 6550				
231	FOX PEREYRA, MARIANA	Murillo 6136				mfox@fox.com.uy
232	PITTALUGA ROSSI, GABRIEL MARÍA	Echevarriarza 3535, esc. 1601				gabrielpittaluga1@gmail.com
233	MARY PATRICIA CHAVES TELIZ					dra.patriciachavesteliz@gmail.com
234	MANUELA CABRERA SALVO	Juan Paullier 1236				manuela.cabrera82@gmail.com
235	JONAS KING BERGSTEIN KLECKIN	Av. 18 de Julio 1117 Piso 5°				svila@bergsteinlaw.com
236	KAREN NAHIR FERNÁNDEZ SUÁREZ	Ituzaingo1312/201				Karenfernandezsuarez@gmail.com
237	JUAN JOSÉ CURONE SÁNCHEZ	Rio Branco 1481				juanjocurone@hotmail.com
238	ANA PAULA BIANCHIMANO LOPEZ	Buenos Aires 397 Esc. 601		29152804		

Nro	Nombre	Dirección	CP	Teléfono	Fax	E-mail
239	VILLAMIL RODRÍGUEZ, PABLO	Av. General Flores 2282 unidad 105	11800	2209.61.29 091.096.947		
240	PRIORE GONZALEZ , MARIA BELEN	Avenida Rivera 5511	11400	099.860.427		mbpriere@gmail.com
241	MARCELO FEMENIAS	Treinta y Tres 1271	11200			mfemenias@bkzr.com.uy
242	FLORENCIA TORRESANI	Indiana M30 S2 (Médanos de Solymar, Canelones)	11600			uruguay@balderip.com
243	ANDREA KARINA CALCATERRA	Carlos Puig 1514 (Dolores-Soriano)				
244	FELIPE MARTINEZ ARDOINO	Asturias 1496	11400			felipe@martinezleoni.com.uy
245	JUANA BACOT	25 de Mayo	11000			jbacot@bacot.com.uy
246	CARMELA BACOT KONKE	Echevarriarza 3406				cbacot@bacot.com.uy
247	ESTEBAN NICOLAS CABALLERO MADERA	Plaza Cagancha 1335 Of .206		29023118		ncaballero@jones.com.uy
248	MANUEL GRAÑA GIANONI	Jose Marti 3263 Apto 301		099043466		manuelg90@gmail.com
249	RUBEN GABRIEL MENDEZ IRIGOYEN	Héctor Barrios esq. Circunvalación s/n°				gabrielmendez272@gmail.com

**Advertencia.**

“Es responsabilidad de los Sres. Agentes mantener actualizada la información precedente para su publicación en este Boletín, pudiendo solicitar los cambios que correspondan por correo electrónico dirigido a, Secretaria.DNPI@miem.gub.uy “

Todo usuario que haya presentado o presente una solicitud de registro mediante el Sistema de Presentación en Línea de la DNPI, deberá ingresar al mismo vía web para realizar el seguimiento de su solicitud, revisar los avisos de notificaciones pendientes, y proceder a notificarse. En caso de no seguir el procedimiento de notificación en línea en un plazo de 3 días hábiles, se tendrá por efectuada sin necesidad de constancia alguna comenzando a correr los plazos legales





# ***SOLICITUDES DE MARCAS***

El procedimiento utilizado no permite en todos los casos reproducir con exactitud los distintos matices de los colores.

Para oír los audios de las Marcas Sonoras que se publiquen en el presente Boletín debe ingresar por el siguiente link

<https://www.gub.uy/ministerio-industria-energia-mineria/comunicacion/publicaciones/repositorio-marcas-sonoras>

(210) **521934** (540)  
(730) **Elizabeth Hasteings**; UY  
(220) 04/03/2021  
(511) **44 (S/D)**  
(740) Harwood 6133, Montevideo, 11600,  
Montevideo, Montevideo, UY  
  
(591) Verde



---

(210) **522234** (540)  
(730) **BIOHEALTH GROUP**; CO  
(220) 11/03/2021  
(511) **10 y 44**  
(740) 201  
  
(591) GRIS, NARANJA, BLANCO



---

(210) **522821** (540)  
(730) **Felizo S.A.**; UY  
(220) 05/04/2021  
(511) **44**  
(740) 172

**PRESAGE**

---

(210) **537730** (540)  
(730) **John Rich & Sons Investment Holding**  
**Company; US**  
(220) 23/05/2022  
(511) **18 y 25**  
(740) 201  
(300) 302021000195305 26/11/2021 IT



---

(210) **538066** (540)  
(730) **Noelia Yanill Perez Correa; UY**  
(220) 30/05/2022  
(511) **41 (S/D)**  
(740) ituizango 740, minas, 30000, lavalleja,  
lavalleja, UY



---

(210) **538908** (540)  
(730) **Farinur S.A.; UY**  
(220) 17/06/2022  
(511) **35**  
(740) , , , , , UY

(591) Rojo-Azul-Blanco-Negro



(210) **539141** (540)  
(730) **STARBUCKS CORPORATION; US**  
(220) 23/06/2022  
(511) **7 (S/D) y 11 (S/D)**  
(740) 212  
(300) 97213709 11/01/2022 US

## CLOVER VERTICA

---

(210) **539454** (540)  
(730) **KREATORY S.A.; UY**  
(220) 30/06/2022  
(511) **35**  
(740) 201

(591) AZUL, NEGRO, BLANCO



---

(210) **539751** (540)  
(730) **Oldsemen S.A; UY**  
(220) 06/07/2022  
(511) **30, 35 y 43**  
(740) 212

## ROMANITOS

---

(210) **539833**  
(730) **Keli Network Inc.**; US  
(220) 08/07/2022  
(511) **41 (S/D)**  
(740) 144

(540)

**OH MY GOAL**

---

(210) **539853**  
(730) **Tritón Comunicaciones, S.A. de C.V.**; MX  
(220) 08/07/2022  
(511) **38 (S/D)**  
(740) 212

(540)

(591) rojo



---

(210) **539854**  
(730) **Tritón Comunicaciones, S.A. de C.V.**; MX  
(220) 08/07/2022  
(511) **41 (S/D)**  
(740) 212

(540)

(591) ROJO



(210) **540086** (540)  
(730) **LATAM Group SpA**; CL  
(220) 14/07/2022  
(511) **12 (S/D) y 20 (S/D)**  
(740) 212

(591) naranja y blanco



---

(210) **540130** (540)  
(730) **Puente Holding Limited**; GB  
(220) 15/07/2022  
(511) **9 (S/D), 36 (S/D) y 42 (S/D)**  
(740) 94

(591) No reivindica colores



---

(210) **540166** (540)  
(730) **PPG INDUSTRIES OHIO, INC.**; US  
(220) 15/07/2022  
(511) **2 (S/D), 9 (S/D), 16 (S/D) y 42 (S/D)**  
(740) 144





(210) **540181** (540)

(730) **ALEL 19 SRL**; UY

(220) 19/07/2022

(511) **35 (S/D)**

(740) AV. ITALIA 4001, , , MONTEVIDEO,  
MONTEVIDEO, UY

(591) Azul y Naranja



---

(210) **540210** (540)

(730) **Xiamen C&D Corporation Limited**; CN

(220) 19/07/2022

(511) **35 (S/D)**

(740) 144

建发

---

(210) **540211** (540)

(730) **Xiamen C&D Corporation Limited**; CN

(220) 19/07/2022

(511) **35 (S/D)**

(740) 144

(591) Azul - Rojo



(210) **540222** (540)  
(730) **EQRx International, Inc.;** US  
(220) 20/07/2022  
(511) **5 (S/D)**  
(740) 245  
(300) 97/253152 04/02/2022 US

## AUMSEQA

---

(210) **540223** (540)  
(730) **EQRx International, Inc.;** US  
(220) 20/07/2022  
(511) **5 (S/D)**  
(740) 245  
(300) 97/253150 04/02/2022 US

## EQJUBI

---

(210) **540244** (540)  
(730) **ADM DO BRASIL LTDA;** BR  
(220) 20/07/2022  
(511) **29 (S/D)**  
(740) 94  
  
(591) verde, amarillo

The logo for 'vitaliv' features the brand name in a lowercase, green, sans-serif font. A small yellow leaf-like graphic is positioned at the end of the word, above the 'v'.

(210) **540271** (540)  
(730) **KANDO INNOVATION LIMITED**; NZ  
(220) 20/07/2022  
(511) **7 (S/D)**  
(740) 216

(591) AZUL ( PANTONE 2945) , BLANCO Y  
NEGRO

 **GUARDIAN**

---

(210) **540283** (540)  
(730) **GRUPO OPCION SAS**; UY  
(220) 21/07/2022  
(511) **11, 12, 29, 35 y 37**  
(740) Rodgen edificio 12 lunas, Punta del Este, ,  
Maldonado, Maldonado, UY

(591) negro,verde agua,amarillo, naranja

  
**GRUPOOPCIÓN**

---

(210) **540287** (540)  
(730) **ADM International Sàrl**; CH  
(220) 21/07/2022  
(511) **1 (S/D), 29 (S/D), 30 (S/D) y 42 (S/D)**  
(740) 94

**EDGEFLEX**

---

(210) **540288** (540)  
(730) **ADM International Sàrl**; CH  
(220) 21/07/2022  
(511) **1 (S/D), 29 (S/D), 30 (S/D) y 42 (S/D)**  
(740) 94

## **NUTRIFLEX**

---

(210) **540299** (540)  
(730) **EURO GAMES TECHNOLOGY LTD.;**  
BG  
(220) 21/07/2022  
(511) **9 (S/D), 28 (S/D) y 41 (S/D)**  
(740) 201

## **BURNING HOT**

---

(210) **540300** (540)  
(730) **EURO GAMES TECHNOLOGY LTD.;**  
BG  
(220) 21/07/2022  
(511) **9 (S/D), 28 (S/D) y 41 (S/D)**  
(740) 201

## **FLAMING HOT**

---

(210) **540301** (540)  
(730) **EURO GAMES TECHNOLOGY LTD.;**  
BG  
(220) 21/07/2022  
(511) **9 (S/D), 28 (S/D) y 41 (S/D)**  
(740) 201

## CRYSTAL WIN

---

(210) **540302** (540)  
(730) **EURO GAMES TECHNOLOGY LTD.;**  
BG  
(220) 21/07/2022  
(511) **9 (S/D), 28 (S/D) y 41 (S/D)**  
(740) 201

## SHINING CROWN

---

(210) **540303** (540)  
(730) **EURO GAMES TECHNOLOGY LTD.;**  
BG  
(220) 21/07/2022  
(511) **9 (S/D), 28 (S/D), 37 (S/D), 38 (S/D), 41**  
**(S/D) y 42 (S/D)**  
(740) 201

(591) ROJO, BLANCO



(210) **540305** (540)  
(730) **EURO GAMES TECHNOLOGY LTD.;**  
BG  
(220) 21/07/2022  
(511) **9 (S/D), 28 (S/D), 37 (S/D), 38 (S/D), 41**  
**(S/D) y 42 (S/D)**  
(740) 201  
  
(591) ROJO, NEGRO, BLANCO



(210) **540306** (540)  
(730) **EURO GAMES TECHNOLOGY LTD.;**  
BG  
(220) 21/07/2022  
(511) **9 (S/D), 28 (S/D), 37 (S/D), 38 (S/D), 41**  
**(S/D) y 42 (S/D)**  
(740) 201  
  
(591) ROJO, NEGRO, BLANCO



(210) **540308** (540)  
(730) **EGT Digital Ltd.;** BG  
(220) 21/07/2022  
(511) **9 (S/D), 28 (S/D), 37 (S/D), 38 (S/D), 41**  
**(S/D) y 42 (S/D)**  
(740) 201  
  
(591) ROJO, BLANCO



(210) **540362** (540)  
(730) **GRANDES PROYECTOS SAS; UY**  
(220) 22/07/2022  
(511) **41**  
(740) Av.Italia 4309, Montevideo, 11400,  
Montevideo, Montevideo, UY

## MUNDO BAMBINO

---

(210) **540363** (540)  
(730) **GRANDES PROYECTOS SAS; UY**  
(220) 22/07/2022  
(511) **41**  
(740) Av.Italia 4309, Montevideo, 11400,  
Montevideo, Montevideo, UY

## GRAVITY

---

(210) **540372** (540)  
(730) **REYES MAIRET, NICOLAS Y REYES  
MAIRET, MATHIAS SOCIEDAD DE  
HECHO; UY**  
(220) 22/07/2022  
(511) **30**  
(740) 34  
  
(591) 0



(210) **540373** (540)  
(730) **FERRERO S.P.A.; IT**  
(220) 22/07/2022  
(511) **30 (S/D)**  
(740) 212

(591) negro, azul, rojo anaranjado, blanco, amarillo,  
naranja, verde



(210) **540377** (540)  
(730) **FERRERO S.P.A.; IT**  
(220) 22/07/2022  
(511) **30 (S/D)**  
(740) 212

(591) negro, azul, rojo anaranjado, blanco, amarillo,  
naranja



(210) **540383** (540)  
(730) **SAUDI ELECTRONIC GAMING  
HOLDING COMPANY; SA**  
(220) 22/07/2022  
(511) **9 (S/D), 16 (S/D), 28 (S/D), 35 (S/D), 38  
(S/D), 41 (S/D) y 42 (S/D)**  
(740) 194  
(300) UK00003746741 24/01/2022 UK

**SAVVY GAMES STUDIO**



(210) **540384** (540)  
(730) **SAUDI ELECTRONIC GAMING  
HOLDING COMPANY; SA**  
(220) 22/07/2022  
(511) **9 (S/D), 16 (S/D), 28 (S/D), 35 (S/D), 38  
(S/D), 41 (S/D) y 42 (S/D)**  
(740) 194  
(300) UK00003746717 24/01/2022 UK

## **SAVVY GAMING GROUP**

---

(210) **540385** (540)  
(730) **SAUDI ELECTRONIC GAMING  
HOLDING COMPANY; SA**  
(220) 22/07/2022  
(511) **9 (S/D), 16 (S/D), 28 (S/D), 35 (S/D), 38  
(S/D), 41 (S/D) y 42 (S/D)**  
(740) 194  
(300) UK00003746728 24/01/2022 UK

## **SAVVY GAMES GROUP**

---

(210) **540386** (540)  
(730) **SAUDI ELECTRONIC GAMING  
HOLDING COMPANY; SA**  
(220) 22/07/2022  
(511) **9 (S/D), 16 (S/D), 28 (S/D), 35 (S/D), 38  
(S/D), 41 (S/D) y 42 (S/D)**  
(740) 194  
(300) UK00003746736 24/01/2022 UK

## **SAVVY GAMES FUNDS**

---

(210) **540389** (540)  
(730) **Eliana Soledad Armand Ugon Suarez**; UY  
(220) 25/07/2022  
(511) **25 y 35**  
(740) Río Yí manzana 9 solar 5, Solymar, Ciudad  
de la Costa, , Canelones, Canelones, UY



---

(210) **540396** (540)  
(730) **VFS Global Services PLC**; GB  
(220) 25/07/2022  
(511) **9, 16, 35, 38, 39 y 42**  
(740) 163

(591) No reivindica colores



---

(210) **540397** (540)  
(730) **EL IMPERIO DE LA PIZZA**; UY  
(220) 25/07/2022  
(511) **30 (S/D) y 43 (S/D)**  
(740) FLORENCIO SANCHEZ 303, LA PAZ, ,  
CANELONES, CANELONES, UY

**EL IMPERIO DE LA PIZZA**

---

(210) **540423** (540)  
(730) **SOCIEDADE DE BEBIDAS PANIZZON**  
**LTDA.; BR**  
(220) 25/07/2022  
(511) **30 (S/D)**  
(740) 34

(591) ROJO, BLANCO, NEGRO



---

(210) **540465** (540)  
(730) **CONFEDERACIÓN SUDAMERICANA**  
**DE FÚTBOL; PY**  
(220) 26/07/2022  
(511) **35 (S/D), 38 (S/D) y 41 (S/D)**  
(740) 94

(591) No reivindica colores



---

(210) **540483** (540)  
(730) **SEDER INDÚSTRIA E COMÉRCIO DE**  
**MÓVEIS LTDA.; BR**  
(220) 26/07/2022  
(511) **35 (S/D)**  
(740) 194

**ORNARE**

---

(210) **540509** (540)  
(730) **AD AREA DESIGN SAS; UY**  
(220) 27/07/2022  
(511) **35 y 42**  
(740) 201



---

(210) **540521** (540)  
(730) **LEASINGCAR SOCIEDAD ANÓNIMA;**  
UY  
(220) 27/07/2022  
(511) **12, 35, 36, 37 y 39**  
(740) 144

(591) Azul



---

(210) **540525** (540)  
(730) **EUROPEAN COSMETICS LTDA; UY**  
(220) 27/07/2022  
(511) **32**  
(740) RUTA 5 KM 36, JUANICO, 90400,  
CANELONES, CANELONES, UY

**ECOBIER**

---

(210) **540531** (540)

(730) **Fernando Olivera Costa**; UY

(220) 27/07/2022

(511) **11 (S/D)**

(740) Gregorio Sanabria 909 Piriapolis, Piriapolis, ,  
Maldondo, Maldondo, UY

(591) Negro

# FORAJIDA

---

(210) **540539** (540)

(730) **M D A COMÉRCIO E TRANSPORTES  
DE CEREAIS LTDA**; BR

(220) 27/07/2022

(511) **29 (S/D)**

(740) 212

(591) DORADO, NEGRO, AMARILLO, ROJO

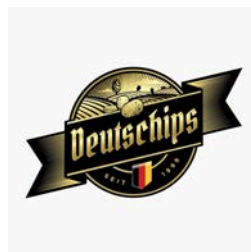

---

(210) **540553** (540)

(730) **WERT SAS**; UY

(220) 28/07/2022

(511) **45 (S/D)**

(740) Jose Enrique Rodo 1711 ap. 302,  
Montevideo, , Montevideo, Montevideo, UY

# GPSYA

---

(210) **540559** (540)  
(730) **JORGE EDUARDO SERRON BAUZIL;**  
UY  
(220) 28/07/2022  
(511) **35 (S/D)**  
(740) AV. GIANNATTASIO M151 S L, EL PINAR,  
, CANELONES, CANELONES, UY



---

(210) **540560** (540)  
(730) **ADM International Sàrl;** CH  
(220) 28/07/2022  
(511) **1 (S/D), 29 (S/D) y 30 (S/D)**  
(740) 94

**ACCELFLEX**

---

(210) **540561** (540)  
(730) **ADM International Sàrl;** CH  
(220) 28/07/2022  
(511) **1 (S/D), 29 (S/D) y 30 (S/D)**  
(740) 94

**MAXFLEX**

---

(210) **540562** (540)  
(730) **ADM International Sàrl**; CH  
(220) 28/07/2022  
(511) **1 (S/D), 29 (S/D), 30 (S/D) y 31 (S/D)**  
(740) 94

## NUTRISTEM

---

(210) **540592** (540)  
(730) **SOLE D'ESTE SAS EN FORMACIÓN**;  
UY  
(220) 28/07/2022  
(511) **14, 18 y 25**  
(740) 220



---

(210) **540606** (540)  
(730) **RPAMAKER SAS**; UY  
(220) 28/07/2022  
(511) **42 (S/D)**  
(740) Canelones 2015, Montevideo, 11200,  
Montevideo, Montevideo, UY

## RPAMAKER

---

(210) **540608** (540)  
(730) **PASACO S.A.**; UY  
(220) 28/07/2022  
(511) **9 y 12**  
(740) 101

**EJEAS**

---

(210) **540617** (540)  
(730) **SOCUR S.A.**; UY  
(220) 29/07/2022  
(511) **35 y 36**  
(740) 194

(591) azul, amarillo y blanco



---

(210) **540631** (540)  
(730) **SANTANDER INVESTMENT BANK LIMITED**; BS  
(220) 29/07/2022  
(511) **9 y 42**  
(740) 194

(591) negro y rojo





(210) **540632** (540)  
(730) **SANTANDER INVESTMENT BANK  
LIMITED; BS**  
(220) 29/07/2022  
(511) **9 y 42**  
(740) 194

(591) negro y rojo

The logo for '1ST' features the number '1' in black and the letters 'ST' in red. A small red flame-like graphic is positioned above the top right of the 'T'.

---

(210) **540636** (540)  
(730) **ORBIS CONSULTORES SAS; UY**  
(220) 29/07/2022  
(511) **35**  
(740) 144

(591) #0096C5, #006995, #003E66, #706F6F,  
#BF2D28, #95251C

The logo for 'ORBIS FACILITY MANAGEMENT' consists of a circular icon with a blue and red gradient, followed by the word 'ORBIS' in a bold, sans-serif font, and 'FACILITY MANAGEMENT' in a smaller font below it.

---

(210) **540637** (540)  
(730) **Jorge Rodríguez Lara y Celia Giménez;  
UY**  
(220) 29/07/2022  
(511) **37**  
(740) 144

(591) #94AA5D, #647D35, #6BC7F0, #1E6C91,  
#0B5274, #1A729F

The logo for 'TERSUS LIMPIEZAS INTEGRALES' features a circular icon with a green and blue gradient, followed by the word 'TERSUS' in a bold, sans-serif font, and 'LIMPIEZAS INTEGRALES' in a smaller font below it.

(210) **540638** (540)  
(730) **REIMA URUGUAY SAS; UY**  
(220) 29/07/2022  
(511) **42**  
(740) 144

(591) #005691, #00365D, #BF2D28, #95251C,  
#2D4069



---

(210) **540639** (540)  
(730) **Jorge Rodríguez Lara; UY**  
(220) 29/07/2022  
(511) **37**  
(740) 144

(591) #706F6F, #444443, #BF2D28, #95251C



---

(210) **540640** (540)  
(730) **Jorge Rodríguez Lara; UY**  
(220) 29/07/2022  
(511) **35, 37, 42 y 45**  
(740) 144

(591) #94AA5D, #647D35, #BF2D28, #95251C,  
#005087, #00365D, #2D4069



(210) **540644** (540)  
(730) **MARIA PAULA FERNANDEZ  
LUZARDO**; UY  
(220) 29/07/2022  
(511) **31 (S/D)**  
(740) EXODO 578, RAFAEL PERAZZA, , SAN  
JOSE, SAN JOSE, UY

**RINCON DEL PINO  
GANADERIA Y  
AGRICULTURA**

---

(210) **540649** (540)  
(730) **Sabiedriba ar ierobežotu atbildību "Baltic  
Bearing Company-Riga"**; LV  
(220) 29/07/2022  
(511) **7 (S/D) y 35 (S/D)**  
(740) 144



---

(210) **540651** (540)  
(730) **COOPERATIVA DE TRABAJO  
ECOSINERGIA**; UY  
(220) 29/07/2022  
(511) **19 y 37**  
(740) Calle Venezuela M 658 S 37 Ap 1, Solymar, ,  
Canelones, Canelones, UY

**BIOFRAMING**

---

(210) **540652** (540)  
(730) **CARMANIA S.R.L.**; UY  
(220) 29/07/2022  
(511) **8**  
(740) 201

(591) NEGRO, ANARANJADO



(210) **540656** (540)  
(730) **GASTON SIMI BARCELÓ**; UY  
(220) 29/07/2022  
(511) **9**  
(740) 212

(591) Negro, blanco, gris, naranja, beige y celeste



(210) **540657** (540)  
(730) **SIMI BARCELO GASTON**; UY  
(220) 29/07/2022  
(511) **28**  
(740) 212

(591) Negro, blanco, gris, naranja, beige y celeste



(210) **540658** (540)  
(730) **GASTON SIMI BARCELÓ**; UY  
(220) 29/07/2022  
(511) **35**  
(740) 212

(591) Negro, blanco, gris, naranja, beige y celeste



---

(210) **540659** (540)  
(730) **Silvana Steinhauser**; UY  
(220) 29/07/2022  
(511) **30 (S/D)**  
(740) Florencio Sánchez 3394, Fray Bentos, 65000,  
Río Negro, Río Negro, UY

(591) negro y blanco



---

(210) **540673** (540)  
(730) **LUKENOR S.A.**; UY  
(220) 01/08/2022  
(511) **5**  
(740) 189

(591) Verde, blanco, negro, gris



(210) **540674** (540)  
(730) **LUKENOR S.A.**; UY  
(220) 01/08/2022  
(511) **5**  
(740) 189  
  
(591) No se reivindican



(210) **540675** (540)  
(730) **MINISTERIO DE AMBIENTE**; UY  
(220) 01/08/2022  
(511) **35 (S/D) y 41 (S/D)**  
(740) PZA.INDEPENDENCIA 710 PISO 6, , ,  
Montevideo, Montevideo, UY



(210) **540676** (540)  
(730) **LIFTEC**; UY  
(220) 01/08/2022  
(511) **6 (S/D)**  
(740) 18 de Julio 1474 esc. 303, Montevideo, ,  
Montevideo, Montevideo, UY

(591) azul y naranja



(210) **540679** (540)  
(730) **Hugo Cesar Benedetti San Pedro y  
Gustavo Gabriel Avakian; AR**  
(220) 01/08/2022  
(511) **29, 30, 31, 32, 33 y 43**  
(740) 144

## GARBATELLA

---

(210) **540695** (540)  
(730) **ANITDOR S.A.; UY**  
(220) 01/08/2022  
(511) **42 y 44**  
(740) 201

(591) Verde, gris, blanco



---

(210) **540696** (540)  
(730) **Okta, Inc.; US**  
(220) 01/08/2022  
(511) **9 (S/D) y 42 (S/D)**  
(740) 194

## OKTA

---

(210) **540698** (540)  
(730) **GPV S.A.**; AR  
(220) 01/08/2022  
(511) **20, 24 y 35 (S/D)**  
(740) 201

(591) NEGRO, BLANCO, ANARANJADO



(210) **540700** (540)  
(730) **EMPRESA PROGRESO S. A.**; UY  
(220) 01/08/2022  
(511) **45**  
(740) 220



(210) **540701** (540)  
(730) **GPV S.A.**; AR  
(220) 01/08/2022  
(511) **20, 24 y 35**  
(740) 201

(591) AZUL, ROJO, BLANCO





(210) **540703** (540)  
(730) **GANI S.A.**; AR  
(220) 01/08/2022  
(511) **20, 24 y 35**  
(740) 201

(591) AZUL, DORADO, BLANCO



---

(210) **540704** (540)  
(730) **EL TRIGAL S.A.**; UY  
(220) 01/08/2022  
(511) **29, 30 y 31**  
(740) 144

## ANILLOS

---

(210) **540711** (540)  
(730) **Pablo Javier Smiriglia**; AR  
(220) 01/08/2022  
(511) **43**  
(740) 215

(591) Verde, negro, blanco, amarillo, marrón y beige.



(210) **540712** (540)  
(730) **Liquor Group Inc.**; PA  
(220) 01/08/2022  
(511) **33 (S/D)**  
(740) 245

## PARIS DE NUIT

---

(210) **540713** (540)  
(730) **King of Queens, Inc.**; PA  
(220) 01/08/2022  
(511) **33 (S/D)**  
(740) 245

## KING OF QUEENS

---

(210) **540718** (540)  
(730) **ZHU XIAOZHONG**; CN  
(220) 02/08/2022  
(511) **7 (S/D) y 12 (S/D)**  
(740) 220  
  
(591) -



(210) **540720** (540)  
(730) **Pablo Javier Smiriglia**; AR  
(220) 02/08/2022  
(511) **43**  
(740) 215

(591) Verde, negro, blanco, amarillo, marrón y beige.



---

(210) **540722** (540)  
(730) **Florencia Cioli**; UY  
(220) 02/08/2022  
(511) **30 (S/D)**  
(740) Cuaró 3139, Bella Vista, 11800, Montevideo, Montevideo, UY

(591) Letras negras



---

(210) **540726** (540)  
(730) **Liangpeng TENG**; CN  
(220) 02/08/2022  
(511) **25 (S/D)**  
(740) 201

**MAAMGIC**

---

(210) **540736** (540)  
(730) **MAD FOR MODERN S.R.L.**; UY  
(220) 02/08/2022  
(511) **20**  
(740) 94

## MAD FOR MODERN

(210) **540739** (540)  
(730) **SANOFI**; FR  
(220) 02/08/2022  
(511) **1 (S/D), 3 (S/D), 5 (S/D), 9 (S/D), 10 (S/D),  
35 (S/D), 38 (S/D), 41 (S/D), 42 (S/D) y 44  
(S/D)**  
(740) 144  
(300) 4846425 22/02/2022 FR  
(591) Pantone 266 C y Pantone black 6C



(210) **540740** (540)  
(730) **Sabiedriba ar ierobežotu atbildību "Baltic  
Bearing Company-Riga"**; LV  
(220) 02/08/2022  
(511) **7 (S/D)**  
(740) 144

(591) Pantone 541 C, Pantone 1815 C, Pantone  
433C, Pantone 429 C



(210) **540741** (540)  
(730) **SANOFI**; FR  
(220) 02/08/2022  
(511) **1 (S/D), 3 (S/D), 5 (S/D), 9 (S/D), 10 (S/D),  
35 (S/D), 38 (S/D), 41 (S/D), 42 (S/D) y 44  
(S/D)**  
(740) 144  
(300) 4847235 25/02/2022 FR

**AT SANOFI, WE CHASE THE  
MIRACLES OF SCIENCE TO  
IMPROVE PEOPLE'S LIVES**

---

(210) **540749** (540)  
(730) **REPROVITA S.A.S**; UY  
(220) 02/08/2022  
(511) **44**  
(740) 244  
  
(591) Verde Pantone 340C y Naranja Pantone 715 C



---

(210) **540751** (540)  
(730) **LIFTEC S.A.**; UY  
(220) 02/08/2022  
(511) **45 (S/D)**  
(740) 18 de Julio 1474 esc. 303, Montevideo, ,  
Montevideo, Montevideo, UY



(210) **540754** (540)  
(730) **RCN TELEVISIÓN S.A.**; CO  
(220) 02/08/2022  
(511) **38 (S/D) y 41 (S/D)**  
(740) 34  
(300) SD2022/0044971 05/05/2022 CO  
(591) PANTONE 2386 C; PANTONE 376 C;  
PANTONE BLACK C



---

(210) **540755** (540)  
(730) **RCN TELEVISIÓN S.A.**; CO  
(220) 02/08/2022  
(511) **38 (S/D) y 41 (S/D)**  
(740) 34  
(300) SD2022/0044970 05/05/2022 CO  
(591) PANTONE 2386 C; PANTONE 376 C;  
PANTONE BLACK C



---

(210) **540759** (540)  
(730) **The Gillette Company LLC**; US  
(220) 02/08/2022  
(511) **3 (S/D)**  
(740) 212

**SPORT PEAK**

---

(210) **540762** (540)  
(730) **R&S consumer goods GmbH; DE**  
(220) 02/08/2022  
(511) **5 (S/D)**  
(740) 212

**MY.SIZE PRO**

---

(210) **540763** (540)  
(730) **R&S consumer goods GmbH; DE**  
(220) 02/08/2022  
(511) **10 (S/D)**  
(740) 212

**MY.SIZE PRO**

---

(210) **540765** (540)  
(730) **R&S consumer goods GmbH; DE**  
(220) 02/08/2022  
(511) **3 (S/D)**  
(740) 212

**LUBE ME**

---

(210) **540766** (540)  
(730) **R&S consumer goods GmbH; DE**  
(220) 02/08/2022  
(511) **5 (S/D)**  
(740) 212

**LUBE ME**

---

(210) **540767** (540)  
(730) **NATALIA CECILIA GONZALEZ -  
MARIA ISABEL MACEDO; AR**  
(220) 02/08/2022  
(511) **25 y 35**  
(740) 163

(591) No reivindica colores

*Beneida*  
tot és gràcia

---

(210) **540771** (540)  
(730) **Nattura Laboratorios, S.A. de C.V.; MX**  
(220) 03/08/2022  
(511) **3 (S/D)**  
(740) 192

**TEC ITALY**

---



(210) **540774** (540)  
(730) **WOTRAY S.A.**; UY  
(220) 03/08/2022  
(511) **9 y 41**  
(740) 201

(591) NEGRO, BLANCO, ANARANJADO



---

(210) **540775** (540)  
(730) **IBSA Institut Biochimique S.A.**; CH  
(220) 03/08/2022  
(511) **10**  
(740) 144

**IBESIA**

---

(210) **540776** (540)  
(730) **Hyundai Motor Company**; KR  
(220) 03/08/2022  
(511) **7 (S/D)**  
(740) 201  
(300) 40-2022-0091077 17/05/2022 KR



(210) **540777** (540)  
(730) **Hyundai Motor Company; KR**  
(220) 03/08/2022  
(511) **10 (S/D)**  
(740) 201  
(300) 40-2022-0091078 17/05/2022 KR  
(591) AZUL, BLANCO



(210) **540778** (540)  
(730) **Hyundai Motor Company; KR**  
(220) 03/08/2022  
(511) **36 (S/D)**  
(740) 201  
(300) 40-2022-0091079 17/05/2022 KR  
(591) AZUL, BLANCO



(210) **540779** (540)  
(730) **Claudio Guattini y Fabricio Bagnuoli; UY**  
(220) 03/08/2022  
(511) **41**  
(740) 220

(591) TONOS DE AMRARILO, VERDE.



(210) **540780**  
(730) **Hyundai Motor Company**; KR  
(220) 03/08/2022  
(511) **39 (S/D)**  
(740) 201  
(300) 40-2022-0091080 17/05/2022 KR  
(591) AZUL, BLANCO.

(540)



---

(210) **540781**  
(730) **CASA PIRQUE S.A.**; AR  
(220) 03/08/2022  
(511) **33 (S/D)**  
(740) 94

(540)

## RIBERA DEL CUARZO

---

(210) **540782**  
(730) **Hyundai Motor Company**; KR  
(220) 03/08/2022  
(511) **7 (S/D)**  
(740) 201  
(300) 40-2022-0091085 17/05/2022 KR  
(591) AZUL, BLANCO.

(540)



(210) **540783** (540)  
(730) **Hyundai Motor Company; KR**  
(220) 03/08/2022  
(511) **10 (S/D)**  
(740) 201  
(300) 40-2022-0091086 17/05/2022 KR  
(591) AZUL, BLANCO



---

(210) **540784** (540)  
(730) **Hyundai Motor Company; KR**  
(220) 03/08/2022  
(511) **36 (S/D)**  
(740) 201  
(300) 40-2022-0091087 17/05/2022 KR  
(591) AZUL, BLANCO



---

(210) **540785** (540)  
(730) **Hyundai Motor Company; KR**  
(220) 03/08/2022  
(511) **39 (S/D)**  
(740) 201  
(300) 40-2022-0091088 17/05/2022 KR  
(591) AZUL, BLANCO



(210) **540790** (540)  
(730) **BELTRAME & CIA.**; UY  
(220) 03/08/2022  
(511) **31 (S/D)**  
(740) 144

(591) rojo, blanco, gris y amarillo



---

(210) **540791** (540)  
(730) **FALABELLA S.A.**; CL  
(220) 03/08/2022  
(511) **9 (S/D) y 35 (S/D)**  
(740) 181

(591) Pantone Nos. 2256C, 636C, 2222C y blanco



---

(210) **540792** (540)  
(730) **Nicolas Pablo Sardi Piano; Nicolás Salvador Grosso Pérez; Raúl Ignacio Santos Reherrmann; Javier José Misa Rodríguez y Jose Martin Garcia Hutnik;**  
UY  
(220) 03/08/2022  
(511) **41**  
(740) 220



(210) **540793** (540)  
(730) **BALIARDA S.A.**; AR  
(220) 03/08/2022  
(511) **5**  
(740) 201

## VODIX

---

(210) **540794** (540)  
(730) **BALIARDA S.A.**; AR  
(220) 03/08/2022  
(511) **5**  
(740) 201

## XEVORT

---

(210) **540795** (540)  
(730) **Daniela Guerra**; UY  
(220) 03/08/2022  
(511) **25 (S/D)**  
(740) Gral.Hornos 4300, Montevideo, ,  
Montevideo, Montevideo, UY

(591) Matices de Rosa y Salmon. Rojo , Negro.



(210) **540796** (540)  
(730) **DE ARMAS LUCIANO, SOFIA; UY**  
(220) 03/08/2022  
(511) **35**  
(740) 201

## ECODELUY

---

(210) **540797** (540)  
(730) **COMESAÑA JORCIN, PATRICIA  
SILVIA y VARELA OTAMENDI,  
MARÍA; UY**  
(220) 03/08/2022  
(511) **35**  
(740) 189  
  
(591) Blanco y dorado



---

(210) **540798** (540)  
(730) **DE ARMAS LUCIANO, SOFIA; UY**  
(220) 03/08/2022  
(511) **10**  
(740) 201

## COPA UY

---

(210) **540801** (540)  
(730) **Jemella Group Limited; GB**  
(220) 03/08/2022  
(511) **3 (S/D), 8 (S/D), 11 (S/D) y 21 (S/D)**  
(740) 201

**GHD**

---

(210) **540803** (540)  
(730) **Jemella Group Limited; GB**  
(220) 03/08/2022  
(511) **3 (S/D), 8 (S/D), 11 (S/D) y 21 (S/D)**  
(740) 201



---

(210) **540804** (540)  
(730) **COMERCIAL DEXIM SpA; CL**  
(220) 03/08/2022  
(511) **25 (S/D)**  
(740) 234

**BAMERS**

---



(210) **540805** (540)  
(730) **Novartis AG**; CH  
(220) 03/08/2022  
(511) **5 (S/D)**  
(740) 201

(591) AZUL OSCURO, AZUL CLARO,  
MAGENTA.



---

(210) **540806** (540)  
(730) **ALGORAND, INC.**; US  
(220) 03/08/2022  
(511) **9 (S/D), 36 (S/D), 41 (S/D) y 42 (S/D)**  
(740) 201

**ALGORAND**

---

(210) **540807** (540)  
(730) **ALGORAND, INC.**; US  
(220) 03/08/2022  
(511) **9 (S/D), 36 (S/D) y 42 (S/D)**  
(740) 201



(210) **540808** (540)  
(730) **Juniper Networks, Inc.**; US  
(220) 03/08/2022  
(511) **9 (S/D) y 42 (S/D)**  
(740) 194  
(300) 85768 18/02/2022 JM

## MIST AI

(210) **540811** (540)  
(730) **SONY MUSIC ENTERTAINMENT**; US  
(220) 03/08/2022  
(511) **9 (S/D), 38 (S/D) y 41 (S/D)**  
(740) 201



(210) **540813** (540)  
(730) **LAKYFOR S.A.**; UY  
(220) 03/08/2022  
(511) **35 y 42**  
(740) 201

(591) ROJO PANTONE 185C, BLANCO

**Advice**

(210) **540815** (540)  
(730) **Sieteveinte SRL**; UY  
(220) 03/08/2022  
(511) **35**  
(740) 245

(591) rojo pantone 185, negro pantone black 6 C



---

(210) **540817** (540)  
(730) **VIRGINIA LIA JACOBS**; AR  
(220) 03/08/2022  
(511) **5 (S/D)**  
(740) Luis Alberto de Herrera 1248 oficina 703,  
Montevideo, , Montevideo, Montevideo, UY

**HENNIA**

---

(210) **540818** (540)  
(730) **PLUSUAN, S.A.**; UY  
(220) 03/08/2022  
(511) **9 y 35**  
(740) 216

(591) Amarillo, negro, gris, violeta, rojo y naranja



(210) **540820** (540)

(730) **The Liverpool Football Club and Athletic  
Grounds Limited; GB**

(220) 03/08/2022

(511) **25 (S/D)**

(740) 216

(591) blanco y negro



---

(210) **540821** (540)

(730) **The Liverpool Football Club and Athletic  
Grounds Limited; GB**

(220) 03/08/2022

(511) **25 (S/D)**

(740) 216

(591) blanco y negro



---

(210) **540824** (540)

(730) **Vertex Pharmaceuticals Incorporated; US**

(220) 03/08/2022

(511) **5 (S/D)**

(740) 216

**ORKAMBI**

---

(210) **540825** (540)

(730) **Vertex Pharmaceuticals Incorporated; US**

(220) 03/08/2022

(511) **5 (S/D)**

(740) 216

(591) Verde, celeste y blanco



---

(210) **540826** (540)

(730) **Vertex Pharmaceuticals Incorporated; US**

(220) 03/08/2022

(511) **5 (S/D)**

(740) 216

**KALYDECO**

---

(210) **540827** (540)

(730) **Vertex Pharmaceuticals Incorporated; US**

(220) 03/08/2022

(511) **5 (S/D)**

(740) 216

(591) Blanco y negro



(210) **540830** (540)  
(730) **Diego Carlotta**; UY  
(220) 04/08/2022  
(511) **41 (S/D)**  
(740) Avda Italia 6420, MONTEVIDEO, 11500,  
MONTEVIDEO, MONTEVIDEO, UY  
(300) 1 01/07/2022 UY

## SOUNDCITY

---

(210) **540831** (540)  
(730) **Maria Agustina Olivera Couto**; UY  
(220) 04/08/2022  
(511) **3 (S/D), 5 y 32**  
(740) 219

## OLA

---

(210) **540832** (540)  
(730) **E. REMY MARTIN & C°**; FR  
(220) 04/08/2022  
(511) **33 (S/D)**  
(740) 144

## LOUIS XIII

---

(210) **540833** (540)  
(730) **Sociedad Anónima Damm**; ES  
(220) 04/08/2022  
(511) **32 (S/D)**  
(740) 181

## TURIA

---

(210) **540835** (540)  
(730) **Maria Fynn**; UY  
(220) 04/08/2022  
(511) **31 (S/D) y 35 (S/D)**  
(740) RAMBLA MAHATMA GHANDI 177 AP  
401, Montevideo, 11300, Montevideo,  
Montevideo, UY

(591) NARANJA Y BLANCO



---

(210) **540836** (540)  
(730) **Maria Fynn**; UY  
(220) 04/08/2022  
(511) **1 (S/D) y 16 (S/D)**  
(740) RAMBLA MAHATMA GHANDI 177 AP  
401, Montevideo, 11300, Montevideo,  
Montevideo, UY

(591) BLANCO Y NEGRO



(210) **540838** (540)  
(730) **DISTRITO S A**; UY  
(220) 04/08/2022  
(511) **35, 37 y 42**  
(740) 220

(591) Tonos de azul y rojo



---

(210) **540839** (540)  
(730) **LADIMIL S.A.**; UY  
(220) 04/08/2022  
(511) **25**  
(740) 129

**ALASKA**

---

(210) **540841** (540)  
(730) **Gramón Bagó de Uruguay S.A.**; UY  
(220) 04/08/2022  
(511) **5**  
(740) 181

**LAXBENE**

---



(210) **540843** (540)

(730) **LIFTEC S.A.**; UY

(220) 04/08/2022

(511) **6 (S/D)**

(740) 18 de Julio 1474 esc. 303 Montevideo,  
Montevideo, , Montevideo, Montevideo, UY

(591) gris y azul



---

(210) **540845** (540)

(730) **ANTIA MOLL Y CIA. S.A.**; UY

(220) 04/08/2022

(511) **5 y 10**

(740) 201

**CURAMAX**

---

(210) **540851** (540)

(730) **JHONATAN SNAIDER y AVI SNAIDER;**

AR

(220) 04/08/2022

(511) **12**

(740) 219



(210) **540853** (540)  
(730) **JHONATAN SNAIDER y AVI SNAIDER;**  
AR  
(220) 04/08/2022  
(511) **12**  
(740) 219

**X NIMAX**

---

(210) **540856** (540)  
(730) **DASS NORDESTE CALÇADOS E**  
**ARTIGOS ESPORTIVOS S.A.;** BR  
(220) 04/08/2022  
(511) **25**  
(740) 144

**TRYON**

---

(210) **540857** (540)  
(730) **JHONATAN SNAIDER y AVI SNAIDER;**  
AR  
(220) 04/08/2022  
(511) **12**  
(740) 219

**MAGAL**

---

(210) **540865** (540)  
(730) **OPRUMIN S.A.;** UY  
(220) 04/08/2022  
(511) **12**  
(740) 34  
  
(591) 0

**SHARP**

---

(210) **540866** (540)  
(730) **Zhejiang Rifeshow Cosmetics Co., Ltd.;**  
CN  
(220) 04/08/2022  
(511) **3 (S/D)**  
(740) 34  
  
(591) 0

**AIRBODY**

---

(210) **540870** (540)  
(730) **CARBAJAL STOPINGI CESAR**  
**AUGUSTO Y ALONSO JAUREGUY**  
**SANTIAGO SOCIEDAD DE HECHO;**  
UY  
(220) 04/08/2022  
(511) **31 (S/D) y 44 (S/D)**  
(740) Convención 1135, Montevideo, 11700,  
Montevideo, Montevideo, UY

**PROFEED**

---

(210) **540871** (540)

(730) **Pacay SRL**; UY

(220) 05/08/2022

(511) **29 y 30**

(740) Carlos Vaz Ferreira 3832, Montevideo,  
11700, Montevideo, Montevideo, UY

(591) blanco , verde oscuro (Pantone 357C), verde  
claro (Pantone 802C)



(210) **540872** (540)

(730) **Pacay SRL**; UY

(220) 05/08/2022

(511) **29 y 30**

(740) Carlos Vaz Ferreira 3832, Montevideo,  
11700, Montevideo, Montevideo, UY

(591) blanco, verde (Pantone 353C), negro  
(Pantone Neutral Black C), tipografía SPACE  
GROTESK MEDIUM



(210) **540873** (540)

(730) **Pacay SRL**; UY

(220) 05/08/2022

(511) **5 y 30**

(740) Carlos Vaz Ferreira 3832, Montevideo,  
11700, Montevideo, Montevideo, UY

**STEVIALITE**

(210) **540874** (540)  
(730) **Pacay SRL**; UY  
(220) 05/08/2022  
(511) **5 y 30**  
(740) Carlos Vaz Ferreira 3832, Montevideo,  
11700, Montevideo, Montevideo, UY

## SUCRALITE

---

(210) **540875** (540)  
(730) **Pacay SRL**; UY  
(220) 05/08/2022  
(511) **29 y 30**  
(740) Carlos Vaz Ferreira 3832, Montevideo,  
11700, Montevideo, Montevideo, UY

## TAMMI BY DAKOS

---

(210) **540876** (540)  
(730) **FALABELLA S.A.**; CL  
(220) 05/08/2022  
(511) **9 y 35**  
(740) 181

(591) Pantone Nos. 2256C, 636C, 2222C y blanco



(210) **540886** (540)  
(730) **MANTRA S.A.**; UY  
(220) 05/08/2022  
(511) **30**  
(740) 144

**LUCHO**

---

(210) **540889** (540)  
(730) **CABIFY ESPAÑA S.L.**; ES  
(220) 05/08/2022  
(511) **39 (S/D)**  
(740) 94

**CABIFY**

---

(210) **540890** (540)  
(730) **CABIFY ESPAÑA S.L.**; ES  
(220) 05/08/2022  
(511) **39 (S/D)**  
(740) 94

(591) Pantone PMS 266

**cabify**

---

(210) **540892** (540)

(730) **BOUDAKIAN BADANIAN, KRIKOR MIKAEL**; UY

(220) 05/08/2022

(511) **41**

(740) 201

(591) Azul y tonos de azul, celeste, turquesa, amarillo, anaranjado, negro, fucsia



---

(210) **540894** (540)

(730) **HENDERSON & CIA. S.A.**; UY

(220) 05/08/2022

(511) **35**

(740) 181

(591) Pantone 2728 C y blanco



---

(210) **540895** (540)

(730) **TELEFONICA MOVILES DEL URUGUAY S.A.**; UY

(220) 05/08/2022

(511) **9 y 38**

(740) 94

**PREPACK**

---

(210) **540898** (540)  
(730) **marcia michelis**; UY  
(220) 05/08/2022  
(511) **43**  
(740) Ramos 4206, Montevideo, 11400,  
Montevideo, Montevideo, UY  
  
(591) blanco y negro



---

(210) **540899** (540)  
(730) **ARBULO PIROTTO, VIRGINIA**; UY  
(220) 05/08/2022  
(511) **42 y 45**  
(740) 201

**VA ORDENADO**

---

(210) **540900** (540)  
(730) **LABORATORIOS PELLIER S.R.L.**; UY  
(220) 05/08/2022  
(511) **3**  
(740) 144

**PROLACID**

---



(210) **540905** (540)  
(730) **ZODIAC INTERNATIONAL  
CORPORATION; PA**  
(220) 05/08/2022  
(511) **5**  
(740) 245

## **PRAZINAL**

---

(210) **540906** (540)  
(730) **ZODIAC INTERNATIONAL  
CORPORATION; PA**  
(220) 05/08/2022  
(511) **5**  
(740) 245

## **TAMIGRON**

---

(210) **540907** (540)  
(730) **ZODIAC INTERNATIONAL  
CORPORATION; PA**  
(220) 05/08/2022  
(511) **5**  
(740) 245

## **EPLINA**

---

(210) **540909** (540)  
(730) **LA DIETETICA SAS**; UY  
(220) 05/08/2022  
(511) **29, 30, 31 y 35**  
(740) 201

(591) VERDE, BLANCO



(210) **540912** (540)  
(730) **DECATHLON SE**; FR  
(220) 05/08/2022  
(511) **3, 9, 11, 12, 14, 18, 20, 21, 22, 24, 25, 28, 29,**  
**30, 32, 35 y 41**  
(740) 194



(210) **540914** (540)  
(730) **Manuela Morales**; UY  
(220) 05/08/2022  
(511) **28**  
(740) 20 de Setiembre 1453, Montevideo, ,  
Montevideo, Montevideo, UY

**POPACHÍS**

(210) **540915**  
(730) **Eli Lilly and Company**; US  
(220) 05/08/2022  
(511) **5 (S/D)**  
(740) 194

(540)

**KISUNLA**

---

(210) **540917**  
(730) **Manuela Morales**; UY  
(220) 05/08/2022  
(511) **28**  
(740) 20 de Setiembre 1453, Montevideo, ,  
Montevideo, Montevideo, UY

(540)

**CLICK**

---

(210) **540918**  
(730) **ANGELINI HOLDING S.P.A.**; IT  
(220) 05/08/2022  
(511) **3 (S/D), 5 (S/D), 10 (S/D), 35 (S/D) y 41 (S/D)**  
(740) 212

(540)



(210) **540919** (540)  
(730) **DARDANELLI PESCE, ALBA GLORIA;**  
UY  
(220) 05/08/2022  
(511) **33 (S/D)**  
(740) 245  
  
(591) -



---

(210) **540922** (540)  
(730) **SHENZHEN NEW GAIN IMPORT &**  
**EXPORT LTD.; CN**  
(220) 05/08/2022  
(511) **8 (S/D)**  
(740) 34  
  
(591) 0

---

(210) **540923** (540)  
(730) **KANIA INDÚSTRIA E COMÉRCIO DE**  
**ACUMULADORES LTDA - EPP; BR**  
(220) 05/08/2022  
(511) **9 (S/D)**  
(740) 34  
  
(591) 0

(210) **540925**  
(730) **SONDOR S.A.**; UY  
(220) 05/08/2022  
(511) **41**  
(740) 34  
  
(591) 0

(540)

*La Karibe*

---

(210) **540927**  
(730) **Chioino Garin Arquitectos SRL**; UY  
(220) 05/08/2022  
(511) **37 y 42**  
(740) 34  
  
(591) azul

(540)

**AXET**

---

(210) **540929**  
(730) **Chioino Garin Arquitectos SRL**; UY  
(220) 05/08/2022  
(511) **37 y 42**  
(740) 34  
  
(591) azul

(540)

**X**

---

(210) **540930** (540)  
(730) **Droguería Hierbas del Oasis S.R.L.;** AR  
(220) 05/08/2022  
(511) **3 (S/D)**  
(740) 212

(591) amarillo, verde, negro



---

(210) **540931** (540)  
(730) **Droguería Hierbas del Oasis S.R.L.;** AR  
(220) 05/08/2022  
(511) **5 (S/D)**  
(740) 212

(591) amarillo, verde, negro



---

(210) **540933** (540)  
(730) **Droguería Hierbas del Oasis S.R.L.;** AR  
(220) 05/08/2022  
(511) **30 (S/D)**  
(740) 212

(591) amarillo, verde, negro



(210) **540936** (540)  
(730) **CARBAJAL STOPINGI CESAR**  
**AUGUSTO Y ALONSO JAUREGUY**  
**SANTIAGO SOCIEDAD DE HECHO;**  
UY  
(220) 05/08/2022  
(511) **31 (S/D) y 44 (S/D)**  
(740) Convención 1135, Montevideo, 11700,  
Montevideo, Montevideo, UY  
  
(591) verde, amarillo, bordó y negro



---

(210) **540937** (540)  
(730) **LINCK PERNAS, CARLOS EMILIANO;**  
UY  
(220) 08/08/2022  
(511) **2, 16, 21, 35 y 41**  
(740) 189  
  
(591) Verde, rojo, celeste, amarillo, blanco, negro



---

(210) **540938** (540)  
(730) **GOLDSTEIN ZONSEJNAS, SERGIO**  
**ADRIÁN; UY**  
(220) 08/08/2022  
(511) **35**  
(740) 189  
  
(591) Azul, blanco, celeste



(210) **540939** (540)  
(730) **Agustin Ortiz**; UY  
(220) 08/08/2022  
(511) **37**  
(740) Lorenzo Perez 3171/704, Montevideo, 11300,  
Montevideo, Montevideo, UY

## CONSTRUCTORA MONTEVIDEO

(210) **540940** (540)  
(730) **LS Corp.**; KR  
(220) 08/08/2022  
(511) **9 (S/D)**  
(740) 201  
(300) 40-2022-0026058 10/02/2022 KR  
(591) AZUL, ROJO, GRIS



(210) **540943** (540)  
(730) **ZAMCA S.A.**; UY  
(220) 08/08/2022  
(511) **40**  
(740) 19  
  
(591) blanco y negro

BOKK



(210) **540944** (540)  
(730) **OPTISOL S.R.L.**; UY  
(220) 08/08/2022  
(511) **8, 11, 18 y 21**  
(740) 220

## BACCUS

---

(210) **540961** (540)  
(730) **GRABOSKI, SEBASTIAN GUILLERMO;**  
AR  
(220) 08/08/2022  
(511) **37**  
(740) 201

(591) AMARILLO, TURQUESA, BLANCO



---

(210) **540969** (540)  
(730) **LABORATORIOS CELSIUS S.A.**; UY  
(220) 08/08/2022  
(511) **5**  
(740) 144

## NOVEDOL

---

(210) **540972** (540)  
(730) **C.O.M. DE LA A.O.U.**; UY  
(220) 08/08/2022  
(511) **44**  
(740) 201

(591) TURQUESA, VIOLETA, BLANCO



(210) **540974** (540)  
(730) **SUCCESSPROD S.R.L.**; UY  
(220) 08/08/2022  
(511) **9, 35 y 42**  
(740) Río Yí Manzana 9 Solar 5, Solymar, Ciudad  
de la Costa, , Canelones, Canelones, UY

(591) Azul, Naranja



(210) **540975** (540)  
(730) **HIBRA COMERCIO DE ALIMENTOS**  
**LTDA**; BR  
(220) 08/08/2022  
(511) **30**  
(740) 144

(591) Pantone 376C



(210) **540979** (540)  
(730) **Cooperativa de Trabajo Helix Uruguay;**  
UY  
(220) 08/08/2022  
(511) **30 (S/D)**  
(740) Juan P. Lamolle 1661, Montevideo, ,  
Montevideo, Montevideo, UY

**HELIX**

---

(210) **540980** (540)  
(730) **AMARAL SCHIAFFINO CARLOS**  
**CESAR , RAMBO HENRIETTE Y**  
**OTROS; UY**  
(220) 08/08/2022  
(511) **35**  
(740) 160  
  
(591) Turquesa, negro y blanco



---

(210) **540982** (540)  
(730) **Gonzalo Alejandro Delgado Moreno; UY**  
(220) 08/08/2022  
(511) **9 y 36**  
(740) CEBOLLATI 1497 APTO 205,  
MONTEVIDEO, 11200, MONTEVIDEO,  
MONTEVIDEO, UY

(591) BLANCO Y AZUL



(210) **540983** (540)  
(730) **AMARAL SCHIAFFINO CARLOS  
CESAR , RAMBO HENRIETTE Y  
OTROS; UY**  
(220) 08/08/2022  
(511) **45**  
(740) 160  
  
(591) Turquesa, negro y blanco



---

(210) **540986** (540)  
(730) **LABORATORIO ELEA PHOENIX S.A.;**  
AR  
(220) 08/08/2022  
(511) **10 (S/D)**  
(740) 34

**EVACOPA**

---

(210) **540987** (540)  
(730) **LABORATORIO ELEA PHOENIX S.A.;**  
AR  
(220) 08/08/2022  
(511) **3 (S/D)**  
(740) 34

**EVAGINA**

---

(210) **540988** (540)  
(730) **LABORATORIO ELEA PHOENIX S.A.;**  
AR  
(220) 08/08/2022  
(511) **5 (S/D)**  
(740) 34

**EVAGINA**

---

(210) **540989** (540)  
(730) **LABORATORIO ELEA PHOENIX S.A.;**  
AR  
(220) 08/08/2022  
(511) **10 (S/D)**  
(740) 34

**EVAGINA**

---

(210) **540990** (540)  
(730) **LABORATORIO ELEA PHOENIX S.A.;**  
AR  
(220) 08/08/2022  
(511) **5 (S/D)**  
(740) 34

**INFILTREX**

---

(210) **540991** (540)  
(730) **LABORATORIO ELEA PHOENIX S.A.;**  
AR  
(220) 08/08/2022  
(511) **5**  
(740) 34

## EMERPIL

---

(210) **540992** (540)  
(730) **LABORATORIO ELEA PHOENIX S.A.;**  
AR  
(220) 08/08/2022  
(511) **5**  
(740) 34

## CVP FLEBO

---

(210) **540993** (540)  
(730) **ACONCAGUA FOODS S.A.;** CL  
(220) 08/08/2022  
(511) **29 (S/D) y 30 (S/D)**  
(740) 212

(591) violeta



(210) **540994** (540)  
(730) **ACONCAGUA FOODS S.A.;** CL  
(220) 08/08/2022  
(511) **30 (S/D)**  
(740) 212

**ACONCAGUA**

---

(210) **540995** (540)  
(730) **LABORATORIO ELEA PHOENIX S.A.;**  
AR  
(220) 08/08/2022  
(511) **5 (S/D)**  
(740) 34

(591) Pantone 2746C

**Gastrotop**

---

(210) **541000** (540)  
(730) **daniel terminelli;** UY  
(220) 08/08/2022  
(511) **33**  
(740) goes 2056, montevideo, 11000, montevideo,  
montevideo, UY

**VINCOLA**

---

(210) **541001** (540)  
(730) **Izder Advisors S.A.**; UY  
(220) 08/08/2022  
(511) **9 y 35**  
(740) 216

(591) Naranja, rosado, violeta y azul

**Talentport**  
by izder

---

(210) **541009** (540)  
(730) **Biohaven Pharmaceutical Ireland DAC**; IE  
(220) 08/08/2022  
(511) **5 (S/D) y 44 (S/D)**  
(740) 216

(591) Blanco y negro



---

(210) **541010** (540)  
(730) **Biohaven Pharmaceutical Ireland DAC**; IE  
(220) 08/08/2022  
(511) **5 (S/D)**  
(740) 216

**NURTEC**

---



(210) **541012** (540)

(730) **DENTAL PRO S.A.S.**; UY

(220) 08/08/2022

(511) **44**

(740) Juan Bautista Alberdi 6253, Montevideo,  
11500, Montevideo, Montevideo, UY

(591) Tonos de azul, blanco y negro



---

(210) **541013** (540)

(730) **DOMINGUEZ BORGES CESAR  
ANDRÉS Y VIOTTI DOMINGUEZ  
NATALIA ERIKA SOCIEDAD DE  
HECHO**; UY

(220) 08/08/2022

(511) **19 (S/D), 35 (S/D) y 42 (S/D)**

(740) MBURUCUYA 2311, Montevideo, 11700,  
Montevideo, Montevideo, UY

**FERREXPRESS**

---

(210) **541014** (540)

(730) **DOMINGUEZ BORGES CESAR  
ANDRÉS Y VIOTTI DOMINGUEZ  
NATALIA ERIKA SOCIEDAD DE  
HECHO**; UY

(220) 08/08/2022

(511) **19 (S/D), 35 (S/D) y 42 (S/D)**

(740) MBURUCUYA 2311, Montevideo, 11700,  
Montevideo, Montevideo, UY

**Ferrexpress**

(591) gris y verde

---

(210) **541025** (540)  
(730) **Immersive Health Solutions LLC; US**  
(220) 09/08/2022  
(511) **9 (S/D), 10 (S/D) y 44 (S/D)**  
(740) 220  
(300) 2166402 14/02/2022 CA

## REALITY PROCESSOR

---

(210) **541026** (540)  
(730) **Immersive Health Solutions LLC; US**  
(220) 09/08/2022  
(511) **9 (S/D), 10 (S/D), 42 (S/D) y 44 (S/D)**  
(740) 220  
(300) 2167560 18/02/2022 CA

## REALITY ONE

---

(210) **541030** (540)  
(730) **ASOS HOLDINGS LIMITED; GB**  
(220) 09/08/2022  
(511) **25 (S/D)**  
(740) 201

## MISS SELFRIDGE

---

(210) **541031** (540)  
(730) **Juan Carlos Jaime Jackson**; UY  
(220) 09/08/2022  
(511) **25 y 28**  
(740) 179

(591) azul, celeste y blanco.



---

(210) **541037** (540)  
(730) **LOLITA SOCIEDAD ANONIMA**; UY  
(220) 09/08/2022  
(511) **14**  
(740) 129

**LOLITA**

---

(210) **541044** (540)  
(730) **ACIL TEXTIL EIRELI**; BR  
(220) 09/08/2022  
(511) **25**  
(740) 144



(210) **541047** (540)  
(730) **NADER COCCARO ALEJANDRO  
JAVIER; UY**  
(220) 09/08/2022  
(511) **37 y 42 (S/D)**  
(740) 186

(591) Dorado 117C, Azul 3025C, Cool Gray 8 C

**ARQPRO**  
Diseño, Arquitectura, BIM

---

(210) **541052** (540)  
(730) **Marketplace Investments LLC; US**  
(220) 09/08/2022  
(511) **35 y 36**  
(740) 94



---

(210) **541053** (540)  
(730) **Marketplace Investments LLC; US**  
(220) 09/08/2022  
(511) **35 y 36**  
(740) 94



(210) **541054** (540)  
(730) **BaYi Rubber Co.,Ltd.**; CN  
(220) 09/08/2022  
(511) **12 (S/D)**  
(740) 125  
  
(591) -

**WONDERLAND**

---

(210) **541055** (540)  
(730) **Cash S.A.**; UY  
(220) 09/08/2022  
(511) **35 y 36**  
(740) 34  
  
(591) AZUL, BLANCO, VERDE



---

(210) **541056** (540)  
(730) **LOJAS RENNER S.A.**; BR  
(220) 09/08/2022  
(511) **18 (S/D)**  
(740) 34  
  
(591) 0

**ATELIER RE**

---

(210) **541058** (540)  
(730) **HIF Global LLC; US**  
(220) 09/08/2022  
(511) **4 (S/D), 37 (S/D), 39 (S/D) y 40 (S/D)**  
(740) 212

## **HIF HIGHLY INNOVATIVE FUELS**

---

(210) **541060** (540)  
(730) **HIF Global LLC; US**  
(220) 09/08/2022  
(511) **4 (S/D), 37 (S/D), 39 (S/D) y 40 (S/D)**  
(740) 212



---

(210) **541061** (540)  
(730) **HIF Global LLC; US**  
(220) 09/08/2022  
(511) **4 (S/D), 37 (S/D), 39 (S/D) y 40 (S/D)**  
(740) 212



(210) **541062** (540)  
(730) **Mapfre Asistencia, Compañía  
Internacional de Seguros y Reaseguros,  
S.A.; ES**  
(220) 09/08/2022  
(511) **9 (S/D), 36 (S/D), 39 (S/D) y 44 (S/D)**  
(740) 245  
  
(591) ROJO

The logo for MAWDY, consisting of the word "MAWDY" in a bold, red, sans-serif font.

---

(210) **541063** (540)  
(730) **Gilead Sciences Ireland UC; IE**  
(220) 09/08/2022  
(511) **5 (S/D)**  
(740) 245

The logo for MACPHIO, consisting of the word "MACPHIO" in a bold, black, sans-serif font.

---

(210) **541064** (540)  
(730) **Widex A/S; DK**  
(220) 09/08/2022  
(511) **35 (S/D) y 44 (S/D)**  
(740) 219  
(300) 18652431 11/02/2022 EM  
(591) Pantone 2665C Loud Indigo

The logo for Hear, featuring a stylized purple ear icon followed by the word "Hear" in a purple, sans-serif font.

(210) **541065** (540)  
(730) **SANTIAGO SÁNCHEZ BEGINO**; UY  
(220) 09/08/2022  
(511) **41**  
(740) 163

(591) pantone: 15-1062 TCX Gold Fusion pantone:  
Reflex Blue XGC



---

(210) **541066** (540)  
(730) **Widex A/S**; DK  
(220) 09/08/2022  
(511) **35 (S/D) y 44 (S/D)**  
(740) 219  
(300) 18652425 11/02/2022 EM  
(591) Pantone 2665C Loud Indigo

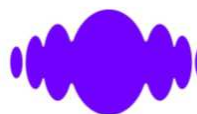

---

(210) **541067** (540)  
(730) **KAWASAKI MOTORS, LTD.**; JP  
(220) 09/08/2022  
(511) **12 (S/D), 35 (S/D) y 37 (S/D)**  
(740) 212

**LET THE GOOD TIMES ROLL**

---



(210) **541070** (540)  
(730) **Martin Pablo Aranda Sojo**; AR  
(220) 09/08/2022  
(511) **35**  
(740) Gral. Nariño 1556 Apto. 202, Montevideo,  
11500, Montevideo, Montevideo, UY

## COLONIA DEL SACRAMENTO MALL

---

(210) **541071** (540)  
(730) **REFRICOM URUGUAY SAS**; UY  
(220) 10/08/2022  
(511) **11 y 35**  
(740) 220  
  
(591) Tonos de azul



---

(210) **541072** (540)  
(730) **Triumph Designs Limited**; GB  
(220) 10/08/2022  
(511) **35 (S/D)**  
(740) 201

## TRIUMPH

---

(210) **541073** (540)  
(730) **Triumph Designs Limited; GB**  
(220) 10/08/2022  
(511) **25 (S/D)**  
(740) 201

The logo for Triumph, featuring the word "TRIUMPH" in a bold, sans-serif font with a curved underline underneath.

---

(210) **541074** (540)  
(730) **YUSUPOFF KLUGMAN, DANIEL  
JAIME y PÉREZ PASTORINO,  
PATRICIA VALERIA; UY**  
(220) 10/08/2022  
(511) **36 (S/D)**  
(740) 189

(591) VERDE, ROJO, BLANCO

The logo for Plenitud, featuring a stylized green leaf with a central orange and yellow flame-like shape, above the word "PLENITUD" in a bold, green, sans-serif font.

---

(210) **541075** (540)  
(730) **GOOD BRANDS LATAM S.A.; PA**  
(220) 10/08/2022  
(511) **5 (S/D)**  
(740) 144

The logo for SunCo POP, featuring the word "SunCo" in a white, sans-serif font above the word "POP" in a white, stylized font with a sun-like glow, all on a black rectangular background.

(210) **541076** (540)  
(730) **GOOD BRANDS LATAM S.A.**; PA  
(220) 10/08/2022  
(511) **5 (S/D)**  
(740) 144

(591) Pantone 361 C; Pantone 527 C; Pantone 213  
C; Pantone Black 7 C



---

(210) **541079** (540)  
(730) **LEGORMAR S.A.**; UY  
(220) 10/08/2022  
(511) **30 y 31**  
(740) 144

(591) Pantone 7625 C; Pantone 7742 C; Pantone  
383C; Pantone Cool Grey 11 C



---

(210) **541080** (540)  
(730) **Martin Miranda**; UY  
(220) 10/08/2022  
(511) **25**  
(740) **RODRIGUEZ LARRETA 2609 APTO 201,**  
Montevideo, 11300, Montevideo,  
Montevideo, UY

**NEW TAUROS**

---

(210) **541082** (540)  
(730) **SKYPOSTAL INC.;** US  
(220) 10/08/2022  
(511) **35 y 39**  
(740) 144

## **SKYPOSTAL SOLUTIONS FOR INTERNATIONAL SHIPPING**

---

(210) **541087** (540)  
(730) **VIRGINIA LIA JACOBS;** AR  
(220) 10/08/2022  
(511) **5 (S/D)**  
(740) Luis Alberto de Herrera 1248 oficina 703,  
Montevideo, , Montevideo, Montevideo, UY

## **ADULT CARE**

---

(210) **541088** (540)  
(730) **DUPONT ELECTRONICS, INC.;** US  
(220) 10/08/2022  
(511) **2 (S/D)**  
(740) 144

## **MICROMAX**

---

(210) **541089** (540)  
(730) **MAPFRE ASISTENCIA, COMPAÑIA  
INTERNACIONAL DE SEGUROS Y  
REASEGUROS, S.A.; ES**  
(220) 10/08/2022  
(511) **9 (S/D), 36 (S/D), 39 (S/D) y 44 (S/D)**  
(740) 245  
  
(591) ROJO



---

(210) **541090** (540)  
(730) **CRACKS UNIVERSITARIOS SAS; UY**  
(220) 10/08/2022  
(511) **35**  
(740) 194  
  
(591) verde y negro



---

(210) **541091** (540)  
(730) **DECATHLON SE; FR**  
(220) 10/08/2022  
(511) **18 y 25**  
(740) 194



(210) **541093** (540)  
(730) **DECATHLON SE**; FR  
(220) 10/08/2022  
(511) **9, 11, 18, 20, 21, 22, 25 y 28**  
(740) 194



---

(210) **541095** (540)  
(730) **TNIN SHOES CALÇADOS E  
ACESSÓRIOS LTDA**; BR  
(220) 10/08/2022  
(511) **25**  
(740) 34  
  
(591) 0

---

(210) **541096** (540)  
(730) **GAC AION NEW ENERGY  
AUTOMOBILE CO., LTD.**; CN  
(220) 10/08/2022  
(511) **7 (S/D), 9 (S/D), 12 (S/D), 35 (S/D) y 37  
(S/D)**  
(740) 34

(210) **541097** (540)  
(730) **GAC AION NEW ENERGY  
AUTOMOBILE CO., LTD.;** CN  
(220) 10/08/2022  
(511) **7 (S/D), 9 (S/D), 12 (S/D), 35 (S/D) y 37  
(S/D)**  
(740) 34  
  
(591) 0

The logo for AION, featuring the word "AION" in a bold, sans-serif font. The letter "A" is stylized with a triangular shape on its left side.

---

(210) **541098** (540)  
(730) **JOIE INTERNATIONAL CO. LTD.;** HK  
(220) 10/08/2022  
(511) **18 (S/D)**  
(740) 34  
  
(591) 0

The logo for Joie, featuring the word "Joie" in a sans-serif font. The letter "i" has a small leaf-like shape above it.

---

(210) **541099** (540)  
(730) **PERMODA LTDA;** CO  
(220) 10/08/2022  
(511) **3 (S/D), 9 (S/D), 14 (S/D), 18 (S/D) y 25  
(S/D)**  
(740) 34  
  
(591) 0

The logo for KOAJ, featuring the word "KOAJ" in a bold, sans-serif font.

(210) **541100** (540)  
(730) **ETIA URUGUAY S.A.**; UY  
(220) 10/08/2022  
(511) **9**  
(740) 34  
  
(591) GRIS, VERDE



---

(210) **541103** (540)  
(730) **DaGrosa Capital Partners LLC**; US  
(220) 10/08/2022  
(511) **36 (S/D)**  
(740) 94  
(300) 97261458 10/02/2022 US

**AXXES CAPITAL**

---

(210) **541105** (540)  
(730) **BLUMENAU ILUMINAÇÃO LTDA.**; BR  
(220) 10/08/2022  
(511) **35 (S/D)**  
(740) 163  
  
(591) No reivindica cores





(210) **541106** (540)

(730) **QUESERÍA COLONIA S.R.L;** UY

(220) 10/08/2022

(511) **29 (S/D)**

(740) Treinta y Tres 178, CANELONES, 90000,  
CANELONES, CANELONES, UY

(591) Negro y Blanco



---

(210) **541113** (540)

(730) **CARLOS ADRIÁN LUCERO CORREA;**  
UY

(220) 11/08/2022

(511) **33**

(740) 129

**AAAH TOLOLO**

---

(210) **541114** (540)

(730) **FERNANDO KONSTANTINOVICH**  
**GARCIA;** UY

(220) 11/08/2022

(511) **6 y 18**

(740) 129

(591) Blanco, negro.

**STATUS**

---

(210) **541115** (540)  
(730) **TONICOR S.A.**; UY  
(220) 11/08/2022  
(511) **35 (S/D)**  
(740) 220

(591) Tonos de rojo y verde



---

(210) **541122** (540)  
(730) **CEAR S.A. - COMPAÑÍA**  
**EMBOTELLADORA DE AGUAS Y**  
**REFRESCOS**; UY  
(220) 11/08/2022  
(511) **32**  
(740) 201

(591) ROJO, NEGRO, BLANCO



---

(210) **541124** (540)  
(730) **CEAR S.A. - COMPAÑÍA**  
**EMBOTELLADORA DE AGUAS Y**  
**REFRESCOS**; UY  
(220) 11/08/2022  
(511) **32**  
(740) 201

(591) AZUL, CELESTE, VERDE, ROJO,  
BLANCO



(210) **541128** (540)  
(730) **Matias Moreno**; UY  
(220) 11/08/2022  
(511) **32 (S/D)**  
(740) Calle C, Numero 7633 - brio san jose de  
carrasco - Canelones, cuidad de la costa ,  
canelones, canelones, UY  
  
(591) Negro Verde



---

(210) **541138** (540)  
(730) **ZHEJIANG GEELY HOLDING GROUP**  
**CO., LTD.**; CN  
(220) 11/08/2022  
(511) **12 (S/D) y 37 (S/D)**  
(740) 94  
  
(591) No reivindica colores



---

(210) **541140** (540)  
(730) **HONDA MOTOR CO., LTD.**; JP  
(220) 11/08/2022  
(511) **12 (S/D)**  
(740) 94

**XRE300 SAHARA**

---

(210) **541144** (540)  
(730) **TCL Technology Group Corporation; CN**  
(220) 11/08/2022  
(511) **7 (S/D), 9 (S/D) y 11 (S/D)**  
(740) 201

## INSPIRE GREATNESS

---

(210) **541146** (540)  
(730) **PASQUET GERSTLE, ANDRES; UY**  
(220) 11/08/2022  
(511) **35**  
(740) 201

(591) Gris, rojo, blanco



---

(210) **541147** (540)  
(730) **The Polo/LAUREN Company L.P.; US**  
(220) 11/08/2022  
(511) **9 (S/D), 35 (S/D), 41 (S/D) y 42 (S/D)**  
(740) 144  
(300) 07350/2022 31/05/2022 CH

## POLO

---

(210) **541148** (540)  
(730) **The Polo/LAUREN Company L.P.;** US  
(220) 11/08/2022  
(511) **9 (S/D), 35 (S/D), 41 (S/D) y 42 (S/D)**  
(740) 144  
(300) 07355/2022 31/05/2022 CH



---

(210) **541149** (540)  
(730) **The Polo/LAUREN Company L.P.;** US  
(220) 11/08/2022  
(511) **9 (S/D), 35 (S/D), 41 (S/D) y 42 (S/D)**  
(740) 144  
(300) 07351/2022 31/05/2022 CH

**RALPH LAUREN**

---

(210) **541150** (540)  
(730) **THE POLO/LAUREN COMPANY, L.P.;**  
US  
(220) 11/08/2022  
(511) **9 (S/D), 35 (S/D), 41 (S/D) y 42 (S/D)**  
(740) 144  
(300) 07352/2022 31/05/2022 CH

**RALPH'S COFFEE**

---

(210) **541151** (540)  
(730) **HUIZHOU ESLINDA TECHNOLOGY**  
**CO.,LTD.;** CN  
(220) 11/08/2022  
(511) **12 (S/D)**  
(740) 144

**TTKIN**

---

(210) **541153** (540)  
(730) **Nintendo of America Inc.;** US  
(220) 11/08/2022  
(511) **18 (S/D), 25 (S/D) y 28 (S/D)**  
(740) 136

(591) No reivindica colores



---

(210) **541158** (540)  
(730) **Nintendo of America Inc.;** US  
(220) 11/08/2022  
(511) **9 (S/D) y 41 (S/D)**  
(740) 136

**POKÉTOON**

---

(210) **541162** (540)  
(730) **WHIRLPOOL PROPERTIES, INC.;** US  
(220) 11/08/2022  
(511) **3 (S/D)**  
(740) 136

## SWASH

---

(210) **541163** (540)  
(730) **Alberto ANGIOLILLO AYUSTO;** UY  
(220) 11/08/2022  
(511) **16**  
(740) **BLANDENGUES 1758, MONTEVIDEO, ,**  
**MONTEVIDEO, MONTEVIDEO, UY**

## PASCUALITO

---

(210) **541170** (540)  
(730) **ASOCIACION CIVIL DE CRIADORES**  
**DE CABALLOS CRIOLLOS DEL**  
**URUGUAY;** UY  
(220) 11/08/2022  
(511) **16 y 41**  
(740) 245

## CRIOLLOS DE AMERICA

---

(210) **541175** (540)  
(730) **Immersive Health Solutions LLC**; US  
(220) 11/08/2022  
(511) **18 (S/D), 28 (S/D), 37 (S/D), 38 (S/D) y 41 (S/D)**  
(740) 220  
(300) 2169026 24/02/2022 CA

## REALITY ONE

(210) **541176** (540)  
(730) **Florencia Belén Siri**; UY  
(220) 11/08/2022  
(511) **35**  
(740) 101

(591) LILA, AMARILLO



(210) **541177** (540)  
(730) **INTENDENCIA DE MONTEVIDEO**; UY  
(220) 12/08/2022  
(511) **41**  
(740) 212

(591) Negro, blanco, amarillo, rosado, celeste,  
verde, azul, naranja





(210) **541178** (540)  
(730) **INTENDENCIA DE MONTEVIDEO; UY**  
(220) 12/08/2022  
(511) **38**  
(740) 212

(591) Negro, blanco, amarillo, rosado, celeste,  
verde, azul, naranja



---

(210) **541181** (540)  
(730) **INTENDENCIA DE MONTEVIDEO; UY**  
(220) 12/08/2022  
(511) **38**  
(740) 212

(591) Verde, rosado, violeta



---

(210) **541182** (540)  
(730) **INTENDENCIA DE MONTEVIDEO; UY**  
(220) 12/08/2022  
(511) **41**  
(740) 212

(591) Verde, rosado, violeta



(210) **541183** (540)  
(730) **INTENDENCIA DE MONTEVIDEO; UY**  
(220) 12/08/2022  
(511) **38**  
(740) 212

(591) Rojo, celeste, azul, blanco



---

(210) **541184** (540)  
(730) **INTENDENCIA DE MONTEVIDEO; UY**  
(220) 12/08/2022  
(511) **41**  
(740) 212

(591) Rojo, celeste, azul, blanco



---

(210) **541188** (540)  
(730) **PAGINAS AMARILLAS S.A.S.; UY**  
(220) 12/08/2022  
(511) **16, 35 y 38**  
(740) 104

(591) Amarillo, Negro, Blanco



(210) **541191** (540)  
(730) **SESAMI CASH MANAGEMENT  
TECHNOLOGIES CORPORATION; CA**  
(220) 12/08/2022  
(511) **6 (S/D), 7 (S/D), 39 (S/D) y 42 (S/D)**  
(740) 201

**SESAMI**

---

(210) **541192** (540)  
(730) **ZONAMERICA S.A.; UY**  
(220) 12/08/2022  
(511) **36**  
(740) 181

(591) Pantone 173C y Negro

 **Bosco**

---

(210) **541194** (540)  
(730) **PAYLOS S.A.; UY**  
(220) 12/08/2022  
(511) **5**  
(740) 189

**Q ALOPEX**

---

(210) **541195** (540)  
(730) **ZONAMERICA S.A.**; UY  
(220) 12/08/2022  
(511) **36**  
(740) 181

(591) No reivindica colores.

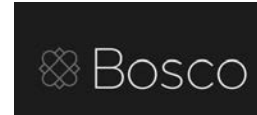

---

(210) **541199** (540)  
(730) **RISOLTUR S.A.**; UY  
(220) 12/08/2022  
(511) **12**  
(740) 201

**FEROZ**

---

(210) **541207** (540)  
(730) **AYMI S.R.L.**; UY  
(220) 12/08/2022  
(511) **5 y 16**  
(740) JUAN LUIS VIVES 5334, MONTEVIDEO, ,  
MONTEVIDEO, MONTEVIDEO, UY

(591) BLANCO



(210) **541209** (540)

(730) **Facundo Borges**; UY

(220) 12/08/2022

(511) **41**

(740) Ciudadela1375/603, Montevideo, 11000,  
Montevideo, Montevideo, UY

(591) Purple C, Violet C, Rhod.Red, Proc.Blue C,  
Yellow C



---

(210) **541211** (540)

(730) **DSM IP Assets B.V.**; NL

(220) 12/08/2022

(511) **5 (S/D) y 31 (S/D)**

(740) 201

(300) 018656506 16/02/2022 EM

## OCHRAZYME

---

(210) **541212** (540)

(730) **SATENIL S.A.**; UY

(220) 12/08/2022

(511) **35 y 38**

(740) 247

(591) Pantone 185 C



(210) **541213** (540)  
(730) **PEPSICO, INC.;** US  
(220) 12/08/2022  
(511) **32**  
(740) 201

## RECARGA TU DIA

---

(210) **541216** (540)  
(730) **EVEREST REAL ESTATE SAS;** UY  
(220) 12/08/2022  
(511) **36**  
(740) 192

(591) Celeste



---

(210) **541217** (540)  
(730) **BASF S.A.;** BR  
(220) 12/08/2022  
(511) **2 (S/D)**  
(740) 144

(591) Rojo, anaranjado, amarillo y negro



(210) **541219** (540)  
(730) **PARKER-MIGLIORINI**  
**INTERNATIONAL DO BRASIL LTDA;**  
BR  
(220) 12/08/2022  
(511) **29 (S/D)**  
(740) 144

## CAMPOS DEL PLATA

---

(210) **541234** (540)  
(730) **BELTRAME & CIA.;** UY  
(220) 12/08/2022  
(511) **31**  
(740) 144

(591) Gris, Beige, Rojo, Amarillo y Blanco



---

(210) **541235** (540)  
(730) **BELTRAME & CIA.;** UY  
(220) 12/08/2022  
(511) **31**  
(740) 144

(591) Celeste, Beige, Amarillo, Blanco, Negro y Rojo



(210) **541246** (540)  
(730) **Diego Álvarez**; UY  
(220) 12/08/2022  
(511) **35, 36 y 37**  
(740) 186  
  
(591) -

PCH  
Punta Chacra

---

(210) **541247** (540)  
(730) **LUCIANO BELLO**; UY  
(220) 12/08/2022  
(511) **11 (S/D)**  
(740) PRESIDENTE BERRO 257 APTO 301,  
MONTEVIDEO, 11200, MONTEVIDEO,  
MONTEVIDEO, UY

**ACORN**

---

(210) **541248** (540)  
(730) **SYNGENTA CROP PROTECTION AG**;  
CH  
(220) 12/08/2022  
(511) **1 (S/D), 5 (S/D) y 44 (S/D)**  
(740) 194

**NATURE BUILT IN**

---



(210) **541250**  
(730) **Kim, Doo Sung**; AR  
(220) 12/08/2022  
(511) **19 (S/D)**  
(740) 212

(540)

## PIEDRAFINA

---

(210) **541254**  
(730) **MAWELL S.A.**; UY  
(220) 12/08/2022  
(511) **6 (S/D), 19 y 37**  
(740) 101

(540)

## ULTRASTAR

---

(210) **541255**  
(730) **MAWELL S.A.**; UY  
(220) 12/08/2022  
(511) **6 (S/D), 19 y 37**  
(740) 101

(540)

(591) AZUL, BLANCO



(210) **541261** (540)  
(730) **Immersive Health Solutions LLC; US**  
(220) 15/08/2022  
(511) **9 (S/D), 10 (S/D), 42 (S/D) y 44 (S/D)**  
(740) 220  
(300) 2168959 24/02/2022 CA

## REALITY PRO

---

(210) **541264** (540)  
(730) **ANTONIO BASSO & FILHOS LTDA.; BR**  
(220) 15/08/2022  
(511) **33**  
(740) 168

(591) NEGRO - BLANCO

**WINE**  
**COOLER**

---

(210) **541266** (540)  
(730) **ANTONIO BASSO & FILHOS LTDA.; BR**  
(220) 15/08/2022  
(511) **33**  
(740) 168

(591) DORADO - NEGRO - BLANCO

  
**CANÇÃO**  
TRADIÇÃO DESDE 1970

(210) **541274** (540)  
(730) **Administración Nacional de  
Telecomunicaciones (Antel); UY**  
(220) 15/08/2022  
(511) **38 (S/D) y 41 (S/D)**  
(740) Guatemala 1075, Montevideo, 11800,  
Montevideo, Montevideo, UY

(591) Azul (pantone 281), celeste (pantone 3255 C),  
blanco



---

(210) **541275** (540)  
(730) **MIXPLAY S.A.; AR**  
(220) 15/08/2022  
(511) **9 (S/D), 35 (S/D) y 42 (S/D)**  
(740) 201

(591) CELESTE, VERDE, AZUL, VIOLETA,  
BLANCO



---

(210) **541277** (540)  
(730) **MIXPLAY S.A.; AR**  
(220) 15/08/2022  
(511) **9 (S/D), 35 (S/D) y 42 (S/D)**  
(740) 201

(591) CELESTE, BLANCO



(210) **541278** (540)  
(730) **Administración Nacional de  
Telecomunicaciones (Antel); UY**  
(220) 15/08/2022  
(511) **38 (S/D) y 41 (S/D)**  
(740) Guatemala 1075, Montevideo, 11800,  
Montevideo, Montevideo, UY

## ANTELEVENTOS

(210) **541279** (540)  
(730) **Zhejiang Qianjiang Motorcycle Co., Ltd.;**  
CN  
(220) 15/08/2022  
(511) **12 (S/D)**  
(740) 201



(210) **541280** (540)  
(730) **BOCACHA FILMS S.A.S.;** UY  
(220) 15/08/2022  
(511) **35 y 41**  
(740) 94

(591) Negro (302e2f), gris (6d8280), rosa (e4cfc1),  
rojo (e03f41)



(210) **541281** (540)  
(730) **Zhejiang Qianjiang Motorcycle Co., Ltd.;**  
CN  
(220) 15/08/2022  
(511) **12 (S/D)**  
(740) 201

**QJIANG**

---

(210) **541293** (540)  
(730) **BURGOS GARCÍA, MARY BEATRIZ;**  
UY  
(220) 15/08/2022  
(511) **35**  
(740) 144  
  
(591) #FF0000 y #000000



---

(210) **541315** (540)  
(730) **Pablo Giordano; UY**  
(220) 15/08/2022  
(511) **42**  
(740) Durazno 1504, Montevideo, 11200,  
Montevideo, Montevideo, UY

**ARCANUS**

---

(210) **541319** (540)  
(730) **Alejandro Pastori**; UY  
(220) 15/08/2022  
(511) **9 y 35 (S/D)**  
(740) Avenida Brasil 2841, Apt. 101, Montevideo,  
11300, Montevideo, Montevideo, UY

## ARREGLOS YA

---

(210) **541330** (540)  
(730) **Fideicomiso de Administración del Museo  
del Carnaval**; UY  
(220) 15/08/2022  
(511) **41**  
(740) 101

## SALA DEL MUSEO DEL CARNAVAL

---

(210) **541334** (540)  
(730) **Blumarel S.A.**; UY  
(220) 15/08/2022  
(511) **7, 8, 9, 11, 35, 37 y 39**  
(740) 194

(591) Pantones 7467 C y 425 C

The logo for 'elden' is displayed in a lowercase, sans-serif font. The letter 'e' is colored in a teal or light blue, while the remaining letters 'l', 'd', 'e', 'n' are in a dark grey or black color.

(210) **541336**  
(730) **Blumarel S.A.**; UY  
(220) 15/08/2022  
(511) **11**  
(740) 194

(540)

## SUBZERO

---

(210) **541337**  
(730) **Blumarel S.A.**; UY  
(220) 15/08/2022  
(511) **11**  
(740) 194

(540)

## WOLF

---

(210) **541339**  
(730) **Pentagon S.A.**; UY  
(220) 15/08/2022  
(511) **45 (S/D)**  
(740) Edmundo Bianchi 2400, Montevideo, 13000,  
Montevideo, Montevideo, UY

(540)

(591) Negro y blanco



(210) **541343** (540)  
(730) **ABRA GROUP LIMITED**; GB  
(220) 15/08/2022  
(511) **9 (S/D), 12 (S/D), 16 (S/D), 35 (S/D), 36 (S/D), 37 (S/D), 38 (S/D), 39 (S/D), 41 (S/D), 42 (S/D), 43 (S/D) y 45 (S/D)**  
(740) 34  
(300) 97/285,029 25/02/2022 US

**ABRA**

---

(210) **541348** (540)  
(730) **ANHUI SUNSHINE STATIONERY CO.,LTD**; CN  
(220) 15/08/2022  
(511) **16 (S/D)**  
(740) 34

**FOSKA**

---

(210) **541349** (540)  
(730) **GRUPO PILAR S.A.**; AR  
(220) 15/08/2022  
(511) **31**  
(740) 34  
  
(591) 0

**Zimpi**



(210) **541353** (540)  
(730) **Juan Rodriguez**; UY  
(220) 15/08/2022  
(511) **25**  
(740) Avenida Carlos Racine 3008, Parque  
Roosevelt, 15000, Canelones, Canelones, UY

## FOCUS

---

(210) **541355** (540)  
(730) **daniel terminelli**; UY  
(220) 16/08/2022  
(511) **33**  
(740) GOES 2056, MONTEVIDEO, 11000,  
MONTEVIDEO, MONTEVIDEO, UY

## ROCKOLA

---

(210) **541356** (540)  
(730) **BIMEDA Animal Health Limited**; IE  
(220) 16/08/2022  
(511) **5 (S/D)**  
(740) 179

## MOXISTRIKE

---

(210) **541358** (540)  
(730) **ROTOMOLDEOS NUEVA ERA S.A.**; UY  
(220) 16/08/2022  
(511) **12 (S/D)**  
(740) 189

## NUEVA ERA MARINE

(210) **541365** (540)  
(730) **LEANDRO JAVIER CRISTOBAL**; AR  
(220) 16/08/2022  
(511) **43**  
(740) 186

(591) -

**PARADA  
SANGUCHERA**

(210) **541367** (540)  
(730) **MARIA PAULA FERNANDEZ  
LUZARDO**; UY  
(220) 16/08/2022  
(511) **31 (S/D)**  
(740) EXODO 578, RAFAEL PERAZZA, , SAN  
JOSE, SAN JOSE, UY



(210) **541390** (540)  
(730) **AJS S.R.L.**; UY  
(220) 16/08/2022  
(511) **35**  
(740) 245

(591) AZUL AMARAILLO Y BLANCO



---

(210) **541391** (540)  
(730) **Carlos Fabian Barrales Rodríguez**; UY  
(220) 16/08/2022  
(511) **9 (S/D), 35 (S/D), 37 (S/D) y 42 (S/D)**  
(740) Maldonado 770, San Carlos, 20400,  
Maldonado, Maldonado, UY

(591) Azul, verde y verde claro



---

(210) **541392** (540)  
(730) **nicolas Lecuona**; UY  
(220) 16/08/2022  
(511) **41 (S/D)**  
(740) CALLE 36 MANZANA 386 SOLAR 7  
PARQUE DEL PLATA, PARQUE DEL  
PLATA, 15300, CANELONES,  
CANELONES, UY

(591) NEGRO ROJO Y BLANCO



(210) **541393** (540)  
(730) **LEMARYON S.A.**; UY  
(220) 17/08/2022  
(511) **35**  
(740) 228

(591) Azul, amarillo y blanco



---

(210) **541394** (540)  
(730) **LEMARYON S.A.**; UY  
(220) 17/08/2022  
(511) **35**  
(740) 228

(591) Azul, amarillo y blanco



---

(210) **541395** (540)  
(730) **VALERIA GONZALEZ**; UY  
(220) 17/08/2022  
(511) **44 (S/D)**  
(740) Enrique Azarola 2254, Montevideo, ,  
Montevideo, Montevideo, UY

**ONAH ESTÉTICA**

---

(210) **541405** (540)  
(730) **Administración Nacional de  
Telecomunicaciones (Antel); UY**  
(220) 17/08/2022  
(511) **38 (S/D) y 41 (S/D)**  
(740) Guatemala 1075, Montevideo, 11800,  
Montevideo, Montevideo, UY

(591) Azul (pantone 281), celeste (pantone 3255 C),  
blanco

The logo for antelTV, featuring the word "antel" in a dark blue font and "TV" in a light blue font, with a small light blue dot above the "a".

---

(210) **541406** (540)  
(730) **Administración Nacional de  
Telecomunicaciones (Antel); UY**  
(220) 17/08/2022  
(511) **38 (S/D) y 41 (S/D)**  
(740) Guatemala 1075, Montevideo, 11800,  
Montevideo, Montevideo, UY

(591) Azul (pantone 281), celeste (pantone 3255 C),  
blanco



---

(210) **541407** (540)  
(730) **Administración Nacional de  
Telecomunicaciones (Antel); UY**  
(220) 17/08/2022  
(511) **38 (S/D) y 41 (S/D)**  
(740) Guatemala 1075, Montevideo, 11800,  
Montevideo, Montevideo, UY

(591) Azul (pantone 281), celeste (pantone 3255 C),  
blanco

The logo for eventos, consisting of a light blue speech bubble icon on the left and the word "eventos" in dark blue lowercase letters on the right.

(210) **541408** (540)  
(730) **Administración Nacional de  
Telecomunicaciones (Antel); UY**  
(220) 17/08/2022  
(511) **35 (S/D) y 38 (S/D)**  
(740) Guatemala 1075, Montevideo, 11800,  
Montevideo, Montevideo, UY

## PLANAZO

(210) **541413** (540)  
(730) **DIGITAL IMPORT SAS; UY**  
(220) 17/08/2022  
(511) **29 y 43**  
(740) 248

(591) Amarillo; blanco; rojo; marrón; tonos de  
naranja.

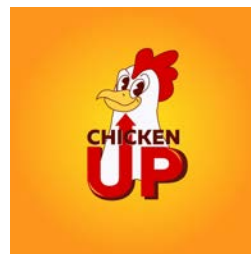

(210) **541414** (540)  
(730) **Suzuki Motor Corporation; JP**  
(220) 17/08/2022  
(511) **9 (S/D), 37 (S/D), 38 (S/D), 39 (S/D), 41  
(S/D) y 42 (S/D)**  
(740) 94

(591) rojo, azul



(210) **541415**  
(730) **ALCESTER S.A.**; UY  
(220) 17/08/2022  
(511) **35, 38, 41 (S/D) y 42**  
(740) 245

(540)

(591) -



---

(210) **541419**  
(730) **Marcos Leonardo Chenlo Silva**; UY  
(220) 17/08/2022  
(511) **35, 39, 42 y 43**  
(740) 248

(540)

(591) Púrpura; blanco; amarillo dorado.



---

(210) **541420**  
(730) **NEKIL S.A.**; UY  
(220) 17/08/2022  
(511) **9**  
(740) 201

(540)

**BENSON & THOMAS**

---

(210) **541422** (540)  
(730) **NATU SAS**; UY  
(220) 17/08/2022  
(511) **35**  
(740) 212

(591) blanco, pantone 801 C y pantone 330 C



---

(210) **541424** (540)  
(730) **RM INDÚSTRIA DE CONFECÇÕES**  
**LTDA**; BR  
(220) 17/08/2022  
(511) **35 (S/D)**  
(740) 212

**RUNMORE**

---

(210) **541425** (540)  
(730) **NATU SAS**; UY  
(220) 17/08/2022  
(511) **39**  
(740) 212

(591) blanco, pantone 801 C y pantone 330 C





(210) **541426** (540)  
(730) **RM INDÚSTRIA DE CONFECÇÕES**  
**LTDA; BR**  
(220) 17/08/2022  
(511) **35 (S/D)**  
(740) 212



---

(210) **541427** (540)  
(730) **NATU SAS; UY**  
(220) 17/08/2022  
(511) **41**  
(740) 212

(591) blanco, pantone 801 C y pantone 330 C



---

(210) **541428** (540)  
(730) **TVLX Viagens e Turismo S.A.; BR**  
(220) 17/08/2022  
(511) **39 (S/D)**  
(740) 34

(591) AZUL, AMARILLO



---

(210) **541429** (540)  
(730) **NATU SAS**; UY  
(220) 17/08/2022  
(511) **43**  
(740) 212

(591) blanco, pantone 801 C y pantone 330 C



---

(210) **541430** (540)  
(730) **NTJ INVESTIMENTOS BRASIL LTDA.;**  
BR  
(220) 17/08/2022  
(511) **12 y 17**  
(740) 34

(591) BLANCO, NEGRO Y ROJO



---

(210) **541431** (540)  
(730) **KANIA INDÚSTRIA E COMÉRCIO DE**  
**ACUMULADORES LTDA - EPP;** BR  
(220) 17/08/2022  
(511) **9 (S/D)**  
(740) 34

**DUTRA**

---

(210) **541435** (540)  
(730) **Leticia Reiris y María Alegre**; UY  
(220) 18/08/2022  
(511) **41 (S/D)**  
(740) Gabriel Pereira 3177 apto 2, Montevideo,  
11300, Montevideo, Montevideo, UY



---

(210) **541437** (540)  
(730) **Esteban Hugo Pivetta**; AR  
(220) 18/08/2022  
(511) **7 (S/D)**  
(740) 220



---

(210) **541438** (540)  
(730) **Esteban Hugo Pivetta**; AR  
(220) 18/08/2022  
(511) **9 (S/D)**  
(740) 220



(210) **541439** (540)  
(730) **KT & G Corporation; KR**  
(220) 18/08/2022  
(511) **34 (S/D)**  
(740) 181

## ACCION

---

(210) **541440** (540)  
(730) **KT & G Corporation; KR**  
(220) 18/08/2022  
(511) **34 (S/D)**  
(740) 181

## ARDOR

---

(210) **541441** (540)  
(730) **KT & G Corporation; KR**  
(220) 18/08/2022  
(511) **34 (S/D)**  
(740) 181

## CUEVA

---

(210) **541442** (540)  
(730) **KT & G Corporation; KR**  
(220) 18/08/2022  
(511) **34 (S/D)**  
(740) 181

## **DIVE**

---

(210) **541443** (540)  
(730) **KT & G Corporation; KR**  
(220) 18/08/2022  
(511) **34 (S/D)**  
(740) 181

## **FUERZA**

---

(210) **541444** (540)  
(730) **KT & G Corporation; KR**  
(220) 18/08/2022  
(511) **34 (S/D)**  
(740) 181

## **LUCERO**

---

(210) **541445** (540)  
(730) **KT & G Corporation; KR**  
(220) 18/08/2022  
(511) **34 (S/D)**  
(740) 181

## MAXIMO

---

(210) **541446** (540)  
(730) **KT & G Corporation; KR**  
(220) 18/08/2022  
(511) **34 (S/D)**  
(740) 181

## MILONGA

---

(210) **541447** (540)  
(730) **KT & G Corporation; KR**  
(220) 18/08/2022  
(511) **34 (S/D)**  
(740) 181

## NOVA

---

(210) **541448** (540)  
(730) **KT & G Corporation; KR**  
(220) 18/08/2022  
(511) **34 (S/D)**  
(740) 181

## **OTRA**

---

(210) **541449** (540)  
(730) **KT & G Corporation; KR**  
(220) 18/08/2022  
(511) **34 (S/D)**  
(740) 181

## **RITMO**

---

(210) **541450** (540)  
(730) **KT & G Corporation; KR**  
(220) 18/08/2022  
(511) **34 (S/D)**  
(740) 181

## **VOLAR**

---

(210) **541451** (540)  
(730) **Daniel Gandini (22.50% de propiedad);  
Claudia Mariana Cristaldo (22,50% de  
propiedad) y Julio Roque Razzuk (55% de  
propiedad); AR**  
(220) 18/08/2022  
(511) **9 (S/D)**  
(740) 101

## LUTZ FERRANDO

---

(210) **541452** (540)  
(730) **Philip Morris Products S.A.; CH**  
(220) 18/08/2022  
(511) **35 (S/D)**  
(740) 201

(591) AZUL , CELESTE



---

(210) **541453** (540)  
(730) **DEYUNTAS INDUMENTARIA S.R.L.;**  
**UY**  
(220) 18/08/2022  
(511) **8 y 35**  
(740) 201

(591) GRIS, NEGRO





(210) **541454** (540)

(730) **DEYUNTAS INDUMENTARIA S.R.L.;**  
UY

(220) 18/08/2022

(511) **25 y 35**

(740) 201

(591) MARRON, BLANCO

 **DEYUNTAS**

---

(210) **541456** (540)

(730) **LABORATORIOS CELSIUS S.A.;** UY

(220) 18/08/2022

(511) **5**

(740) 144

**TRICOSAMINA**

---

(210) **541457** (540)

(730) **LABORATORIOS CELSIUS S.A.;** UY

(220) 18/08/2022

(511) **5**

(740) 144

**BUCOSEPTINE CELSIUS**

---

(210) **541460** (540)  
(730) **Montres Tudor SA**; CH  
(220) 18/08/2022  
(511) **14 (S/D)**  
(740) 144  
(300) 03300/2022 07/03/2022 CH

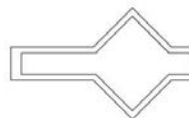

---

(210) **541461** (540)  
(730) **PRINX CHENGSHAN (SHANDONG)**  
**TIRE COMPANY LTD.**; CN  
(220) 18/08/2022  
(511) **12 (S/D)**  
(740) 220  
  
(591) -



---

(210) **541462** (540)  
(730) **Nicolas Costa**; UY  
(220) 18/08/2022  
(511) **43 (S/D)**  
(740) Lima 1332/3, Montevideo, , Montevideo,  
Montevideo, UY  
  
(591) Rojo y verde



(210) **541463** (540)  
(730) **HANGZHOU ALLTEST BIOTECH CO,  
LTD.; CN**  
(220) 18/08/2022  
(511) **5 (S/D) y 10 (S/D)**  
(740) 179

**Beright** 

---

(210) **541464** (540)  
(730) **INTERVET INTERNATIONAL B.V.; NL**  
(220) 18/08/2022  
(511) **5 (S/D)**  
(740) 216

**DEFENTRA**

---

(210) **541465** (540)  
(730) **Danilum S.A.; UY**  
(220) 18/08/2022  
(511) **36, 37, 41 y 43**  
(740) 216

(591) Blanco y negro

*Carlotta*  
BARRIO DE LASO

---

(210) **541467** (540)  
(730) **HANGZHOU ALLTEST BIOTECH CO,  
LTD.;** CN  
(220) 18/08/2022  
(511) **5 (S/D) y 10 (S/D)**  
(740) 179

**JusChek**

---

(210) **541468** (540)  
(730) **HANGZHOU ALLTEST BIOTECH CO,  
LTD.;** CN  
(220) 18/08/2022  
(511) **10 (S/D)**  
(740) 179

(591) Naranja, Negro y Blanco.



---

(210) **541472** (540)  
(730) **Vrio Corp.;** US  
(220) 18/08/2022  
(511) **9 (S/D) y 38 (S/D)**  
(740) 218

(591) AZUL, CELESTE



(210) **541474** (540)  
(730) **Uber Technologies, Inc.**; US  
(220) 18/08/2022  
(511) **9 (S/D), 39 (S/D), 42 (S/D) y 45 (S/D)**  
(740) 34  
(300) 2022-17238 25/03/2022 DO

## UBER ENCARGO

---

(210) **541475** (540)  
(730) **Vrio Corp.**; US  
(220) 18/08/2022  
(511) **9 (S/D) y 38 (S/D)**  
(740) 218  
  
(591) AZUL, CELESTE

The logo for DIRECTV FIBRA, featuring the word "DIRECTV" in blue and "FIBRA" in a smaller blue font to its right.

---

(210) **541482** (540)  
(730) **REBECA MARIA REGINA BOSCH**; UY  
(220) 19/08/2022  
(511) **39 (S/D)**  
(740) AYALA 297, TACUAREMBO, 45000,  
TACUAREMBO, TACUAREMBO, UY  
  
(591) NARANJA Y VERDE/AZUL



(210) **541483** (540)  
(730) **IRMARI LIMITADA**; UY  
(220) 19/08/2022  
(511) **21**  
(740) 189

## FRAGRANCE KIWI

---

(210) **541484** (540)  
(730) **L.H IMPORTACIONES S.A.S.**; UY  
(220) 19/08/2022  
(511) **9**  
(740) 201

## KINGEVER

---

(210) **541485** (540)  
(730) **Kimberly-Clark Worldwide, Inc.**; US  
(220) 19/08/2022  
(511) **16 (S/D)**  
(740) 201

(591) tono de grises y blanco



(210) **541493** (540)  
(730) **HRU S.A.**; UY  
(220) 19/08/2022  
(511) **9, 28, 31, 35, 36, 41, 43 y 44**  
(740) 144  
  
(591) Ver Adjunto

The logo for MAROÑAS features the word in a bold, sans-serif font. The letter 'O' is replaced by a yellow circle with a black outline.

---

(210) **541496** (540)  
(730) **BANCO DE LA PROVINCIA DE BUENOS AIRES**; UY  
(220) 19/08/2022  
(511) **16, 35 y 36**  
(740) 201  
  
(591) GRIS, VERDE, CELESTE, BLANCO

The logo for Provincia Casa Financiera consists of the text "Provincia Casa Financiera" in a sans-serif font, followed by a green square icon containing a white stylized shape.

---

(210) **541498** (540)  
(730) **FERNÁNDEZ GIAMBRUNO JOAQUIN Y FERNÁNDEZ GIAMBRUNO MATEO SOCIEDAD DE HECHO**; UY  
(220) 19/08/2022  
(511) **36**  
(740) 34  
  
(591) pantone 5fba98, pantone ee8734

The logo for prestario features the word in a lowercase, sans-serif font. The letter 'o' is replaced by a green circle with a white outline.

(210) **541499** (540)

(730) **HENDERSON & CIA. S.A.**; UY

(220) 19/08/2022

(511) **30 (S/D)**

(740) Echevarriarza 3535, Suite 1601, Montevideo,  
11300, Montevideo, Montevideo, UY

(591) Pantone Neutral Black, Pantone 155C,  
Blanco



---

(210) **541500** (540)

(730) **FALABELLA S.A.**; CL

(220) 19/08/2022

(511) **9, 35 y 36**

(740) 181

**FPAY LATER**

---

(210) **541501** (540)

(730) **Mijael Lichtenstein y Pablo Maman**; UY

(220) 19/08/2022

(511) **36**

(740) 172

**CIPIA**

---



(210) **541502** (540)  
(730) **Mijael Lichtenstein y Pablo Maman; UY**  
(220) 19/08/2022  
(511) **36**  
(740) 172

## CUORE

---

(210) **541508** (540)  
(730) **ENDIFAR S.A.; UY**  
(220) 19/08/2022  
(511) **35**  
(740) 218

(591) Azul claro (pantone 291 c) marrón (pantone 7565 c) marrón claro (pantone 7411 c), tonos de azul, negro y blanco.



---

(210) **541513** (540)  
(730) **SOFTYS S.A.; CL**  
(220) 19/08/2022  
(511) **3**  
(740) 218

## NOVA

---

(210) **541514** (540)

(730) **María Belén Carrion Acosta**; UY

(220) 19/08/2022

(511) **3**

(740) JUNCAL 1431 APTO 501, Montevideo,  
11000, Montevideo, Montevideo, UY

(591) VERDE Y BLANCO



---

(210) **541515** (540)

(730) **SOFTYS S.A.**; CL

(220) 19/08/2022

(511) **3**

(740) 218

(591) azul, gris y blanco



---

(210) **541518** (540)

(730) **IXALAB S.A.S.**; UY

(220) 19/08/2022

(511) **9, 35, 36, 38, 39 y 42**

(740) 228

**ixalab**

---

(210) **541519** (540)  
(730) **Faron Pharmaceuticals Oy**; FI  
(220) 19/08/2022  
(511) **5 (S/D)**  
(740) 181  
(300) 018665892 02/03/2022 EM

## BEXIGNUS

---

(210) **541521** (540)  
(730) **Faron Pharmaceuticals Oy**; FI  
(220) 19/08/2022  
(511) **5 (S/D)**  
(740) 181  
(300) 018665893 02/03/2022 EM

## BEXCLEVY

---

(210) **541522** (540)  
(730) **Agustin Groba**; UY  
(220) 19/08/2022  
(511) **2 (S/D) y 17 (S/D)**  
(740) Misiones 1475/401, Montevideo, 11000,  
Montevideo, Montevideo, UY

(591) Blanco y negro



(210) **541523** (540)  
(730) **Luis Pablo Franzini-Battle March; UY**  
(220) 19/08/2022  
(511) **25 (S/D)**  
(740) San José 1338, Montevideo, 11100,  
Montevideo, Montevideo, UY

(591) BLANCO NEGRO AZUL Y AMARILLO

**narciso**  
UNDERWEAR EXPERTS

(210) **541526** (540)  
(730) **KENDY BRINQUEDOS LTDA.; BR**  
(220) 22/08/2022  
(511) **28 (S/D)**  
(740) 163

(591) VER DETALLE DE COLORES EN  
ADJUNTO

**Kendy**

(210) **541527** (540)  
(730) **FERNANDO RUBEN POZO; AR**  
(220) 22/08/2022  
(511) **35**  
(740) Brasil 3372, Fray Bentos, 65000, Rio Negro,  
Rio Negro, UY  
(300) 1 24/01/2022 AR

**CIRCULAR ORIENTAL**

(210) **541531** (540)  
(730) **felipe benedetti**; UY  
(220) 22/08/2022  
(511) **14 (S/D), 18 (S/D) y 25 (S/D)**  
(740) palmas y ombues 5879, montevideo, 11400,  
Montevideo, Montevideo, UY

**HEAFF**

(210) **541536** (540)  
(730) **SUCESIÓN RAMÓN SÁNCHEZ  
NOGUEIRA LIMITADA**; UY  
(220) 22/08/2022  
(511) **35**  
(740) COLONIA 811, MONTEVIDEO, 11100,  
MONTEVIDEO, MONTEVIDEO, UY  
  
(591) VERDE, DORADO Y BLANCO



(210) **541539** (540)  
(730) **TRAVEL RESERVATIONS S.R.L.**; UY  
(220) 22/08/2022  
(511) **39 (S/D) y 41 (S/D)**  
(740) 34

(591) PANTONE: 2126 C ; PANTONE: 565 C ;  
PANTONE: 7596 C



(210) **541540** (540)  
(730) **Javier Eduardo Amuchastegui**; AR  
(220) 22/08/2022  
(511) **43 (S/D)**  
(740) 144



---

(210) **541541** (540)  
(730) **Fulvier S.A.**; UY  
(220) 22/08/2022  
(511) **9 (S/D)**  
(740) 136

**HERCULES**

---

(210) **541544** (540)  
(730) **REFRISHOP S.A.**; UY  
(220) 22/08/2022  
(511) **11 y 37**  
(740) 167

**CASA CHALAR**

---

(210) **541553** (540)  
(730) **Foshan Alpicool Electric Appliance Co., Ltd.**; CN  
(220) 22/08/2022  
(511) **6 (S/D), 11 (S/D), 35 (S/D) y 43 (S/D)**  
(740) 201



---

(210) **541556** (540)  
(730) **MABLE S.A.**; UY  
(220) 22/08/2022  
(511) **30 (S/D)**  
(740) 94

(591) Negro, blanco, marrón



---

(210) **541557** (540)  
(730) **Virginia Chivetti**; AR  
(220) 22/08/2022  
(511) **31 y 33**  
(740) Intendente Suarez 161 - Colonia, Colonia,  
70000, Colonia, Colonia, UY

(591) dorado negro



(210) **541560** (540)  
(730) **ENERGY GROUP S.R.L.**; AR  
(220) 22/08/2022  
(511) **32**  
(740) 34

(591) NEGRO, ROJO Y BLANCO



(210) **541562** (540)  
(730) **ENERGY GROUP S.R.L.**; AR  
(220) 22/08/2022  
(511) **32 y 33**  
(740) 34

**LIMITE**

(210) **541563** (540)  
(730) **DIEGO BATTISTE**; UY  
(220) 22/08/2022  
(511) **16**  
(740) 34

(591) VERDE, NEGRO, BLANCO





(210) **541568** (540)  
(730) **SUCESIÓN RAMÓN SÁNCHEZ**  
**NOGUEIRA LIMITADA; UY**  
(220) 22/08/2022  
(511) **34 (S/D)**  
(740) COLONIA 811, MONTEVIDEO, 11100,  
MONTEVIDEO, MONTEVIDEO, UY

## TOKIO

---

(210) **541569** (540)  
(730) **SUCESIÓN RAMÓN SÁNCHEZ**  
**NOGUEIRA LIMITADA; UY**  
(220) 22/08/2022  
(511) **34 (S/D)**  
(740) COLONIA 811, MONTEVIDEO, 11100,  
MONTEVIDEO, MONTEVIDEO, UY

## BERLÌN

---

(210) **541570** (540)  
(730) **SUCESIÓN RAMÓN SÁNCHEZ**  
**NOGUEIRA LIMITADA; UY**  
(220) 22/08/2022  
(511) **34 (S/D)**  
(740) COLONIA 811, MONTEVIDEO, 11100,  
MONTEVIDEO, MONTEVIDEO, UY

## NAIROBI

---

(210) **541571** (540)  
(730) **SUCESIÓN RAMÓN SÁNCHEZ**  
**NOGUEIRA LIMITADA; UY**  
(220) 22/08/2022  
(511) **34 (S/D)**  
(740) COLONIA 811, MONTEVIDEO, 11100,  
MONTEVIDEO, MONTEVIDEO, UY

## ESTOCOLMO

---

(210) **541572** (540)  
(730) **SUCESIÓN RAMÓN SÁNCHEZ**  
**NOGUEIRA LIMITADA; UY**  
(220) 22/08/2022  
(511) **34 (S/D)**  
(740) COLONIA 811, MONTEVIDEO, 11100,  
MONTEVIDEO, MONTEVIDEO, UY

## BOGOTA

---

(210) **541573** (540)  
(730) **SUCESIÓN RAMÓN SÁNCHEZ**  
**NOGUEIRA LIMITADA; UY**  
(220) 22/08/2022  
(511) **34 (S/D)**  
(740) COLONIA 811, MONTEVIDEO, 11100,  
MONTEVIDEO, MONTEVIDEO, UY

## LISBOA

---

(210) **541574** (540)  
(730) **SUCESIÓN RAMÓN SÁNCHEZ**  
**NOGUEIRA LIMITADA; UY**  
(220) 22/08/2022  
(511) **34 (S/D)**  
(740) COLONIA 811, MONTEVIDEO, 11100,  
MONTEVIDEO, MONTEVIDEO, UY

## HELSINKI

---

(210) **541575** (540)  
(730) **SUCESIÓN RAMÓN SÁNCHEZ**  
**NOGUEIRA LIMITADA; UY**  
(220) 22/08/2022  
(511) **34 (S/D)**  
(740) COLONIA 811, MONTEVIDEO, 11100,  
MONTEVIDEO, MONTEVIDEO, UY

## MARSELLA

---

(210) **541576** (540)  
(730) **SUCESIÓN RAMÓN SÁNCHEZ**  
**NOGUEIRA LIMITADA; UY**  
(220) 22/08/2022  
(511) **34 (S/D)**  
(740) COLONIA 811, MONTEVIDEO, 11100,  
MONTEVIDEO, MONTEVIDEO, UY

## MOSCU

---

(210) **541577** (540)  
(730) **SUCESIÓN RAMÓN SÁNCHEZ**  
**NOGUEIRA LIMITADA; UY**  
(220) 22/08/2022  
(511) **34 (S/D)**  
(740) COLONIA 811, MONTEVIDEO, 11100,  
MONTEVIDEO, MONTEVIDEO, UY

## BLANQUILLO

---

(210) **541578** (540)  
(730) **SUCESIÓN RAMÓN SÁNCHEZ**  
**NOGUEIRA LIMITADA; UY**  
(220) 22/08/2022  
(511) **34 (S/D)**  
(740) COLONIA 811, MONTEVIDEO, 11100,  
MONTEVIDEO, MONTEVIDEO, UY

## ACUARELA

---

(210) **541579** (540)  
(730) **SUCESIÓN RAMÓN SÁNCHEZ**  
**NOGUEIRA LIMITADA; UY**  
(220) 22/08/2022  
(511) **34 (S/D)**  
(740) COLONIA 811, MONTEVIDEO, 11100,  
MONTEVIDEO, MONTEVIDEO, UY

## RAICES

---

(210) **541580** (540)  
(730) **SUCESIÓN RAMÓN SÁNCHEZ**  
**NOGUEIRA LIMITADA; UY**  
(220) 22/08/2022  
(511) **34 (S/D)**  
(740) COLONIA 811, MONTEVIDEO, 11100,  
MONTEVIDEO, MONTEVIDEO, UY

## TRINQUETILLA

---

(210) **541581** (540)  
(730) **SUCESIÓN RAMÓN SÁNCHEZ**  
**NOGUEIRA LIMITADA; UY**  
(220) 22/08/2022  
(511) **34 (S/D)**  
(740) COLONIA 811, MONTEVIDEO, 11100,  
MONTEVIDEO, MONTEVIDEO, UY

## CONXO

---

(210) **541582** (540)  
(730) **SUCESIÓN RAMÓN SÁNCHEZ**  
**NOGUEIRA LIMITADA; UY**  
(220) 22/08/2022  
(511) **34 (S/D)**  
(740) COLONIA 811, MONTEVIDEO, 11100,  
MONTEVIDEO, MONTEVIDEO, UY

## CAIGUA

---

(210) **541587** (540)  
(730) **Global Blood Therapeutics, Inc.;** US  
(220) 22/08/2022  
(511) **5 (S/D)**  
(740) 194  
(300) 97377322 22/04/2022 US

## VOCINBEQ

---

(210) **541589** (540)  
(730) **Global Blood Therapeutics, Inc.;** US  
(220) 22/08/2022  
(511) **5 (S/D)**  
(740) 194  
(300) 97377324 22/04/2022 US

## OVEZZO

---

(210) **541592** (540)  
(730) **Global Blood Therapeutics, Inc.;** US  
(220) 22/08/2022  
(511) **5 (S/D)**  
(740) 194  
(300) 97377328 22/04/2022 US

## OVOKLA

---

(210) **541594** (540)  
(730) **Global Blood Therapeutics, Inc.;** US  
(220) 22/08/2022  
(511) **5 (S/D)**  
(740) 194  
(300) 97377330 22/04/2022 US

## ECVOCY

---

(210) **541595** (540)  
(730) **Global Blood Therapeutics, Inc.;** US  
(220) 22/08/2022  
(511) **5 (S/D)**  
(740) 194  
(300) 97377332 22/04/2022 US

## OPROVDA

---

(210) **541596** (540)  
(730) **LA POSTE;** FR  
(220) 22/08/2022  
(511) **9 (S/D), 16 (S/D), 35 (S/D), 36 (S/D), 39 (S/D) y 42 (S/D)**  
(740) 216  
(300) 224846740 23/02/2022 FR  
(591) pantone N° 199C



(210) **541597** (540)  
(730) **Essity Hygiene and Health Aktiebolag; SE**  
(220) 22/08/2022  
(511) **5 (S/D)**  
(740) 194



---

(210) **541600** (540)  
(730) **TAIZHOU ROSEW MACHINERY  
CO.,LTD.; CN**  
(220) 23/08/2022  
(511) **7 (S/D)**  
(740) 201



---

(210) **541601** (540)  
(730) **MOREIRA BESSO, GERARDO DANIEL;  
UY**  
(220) 23/08/2022  
(511) **5 y 30**  
(740) 189

**NUTRIYOGA**

---



(210) **541602** (540)  
(730) **PATAGONIA CANDLES S.R.L.;** AR  
(220) 23/08/2022  
(511) **3 (S/D)**  
(740) 189

(591) No se reivindican

**THE  
CANDLE  
SHOP**

AIR BEAUTY

---

(210) **541603** (540)  
(730) **Quality Is Our Recipe, LLC.;** US  
(220) 23/08/2022  
(511) **43 (S/D)**  
(740) 34

(591) 0



---

(210) **541604** (540)  
(730) **KIRICOCHO S.R.L.;** AR  
(220) 23/08/2022  
(511) **25**  
(740) 201

-FÚTBOL COMPANY-  
**KIRICOCHO**

---

(210) **541612** (540)  
(730) **Gong cha Global Ltd;** GB  
(220) 23/08/2022  
(511) **30 (S/D), 32 (S/D), 35 (S/D) y 43 (S/D)**  
(740) 144

(591) Rojo, negro y Blanco

Gong cha 貢茶

---

(210) **541613** (540)  
(730) **Gong cha Global Ltd;** GB  
(220) 23/08/2022  
(511) **30 (S/D), 32 (S/D), 35 (S/D) y 43 (S/D)**  
(740) 144

(591) Rojo, negro y Blanco



Gong cha

---

(210) **541615** (540)  
(730) **Samsung Electronics Co., Ltd.;** KR  
(220) 23/08/2022  
(511) **7 (S/D) y 11 (S/D)**  
(740) 194  
(300) 40-2022-0050514 18/03/2022 KR

**LAUNDRY HUB**

---

(210) **541619** (540)  
(730) **Kimberly-Clark Worldwide, Inc.**; US  
(220) 23/08/2022  
(511) **3 (S/D) y 16 (S/D)**  
(740) 201

## **KLEENEX ALLERGY COMFORT**

---

(210) **541628** (540)  
(730) **Mateo Pallares**; UY  
(220) 23/08/2022  
(511) **30**  
(740) 154

## **ALFAPRO**

---

(210) **541631** (540)  
(730) **PLATINA COSMÉTICOS LTDA.**; BR  
(220) 23/08/2022  
(511) **3 (S/D)**  
(740) 34  
  
(591) 0

## **SKALA**

---

(210) **541633** (540)  
(730) **ASENCIO RIQUELME, AXEL  
EDUARDO; AR**  
(220) 23/08/2022  
(511) **29 y 30**  
(740) 34  
  
(591) 0



---

(210) **541634** (540)  
(730) **ASENCIO RIQUELME, AXEL  
EDUARDO; AR**  
(220) 23/08/2022  
(511) **29**  
(740) 34  
  
(591) 0



---

(210) **541635** (540)  
(730) **ASENCIO RIQUELME, AXEL  
EDUARDO; AR**  
(220) 23/08/2022  
(511) **30**  
(740) 34  
  
(591) 0



(210) **541637** (540)  
(730) **ServiceRocket Inc.**; US  
(220) 23/08/2022  
(511) **9 (S/D), 35 (S/D), 41 (S/D) y 42 (S/D)**  
(740) 245

## SERVICEROCKET

---

(210) **541638** (540)  
(730) **ZHEJIANG GEELY HOLDING GROUP  
CO., LTD.**; CN  
(220) 23/08/2022  
(511) **12 (S/D) y 37 (S/D)**  
(740) 94

(591) No reivindica colores



---

(210) **541639** (540)  
(730) **ZHEJIANG GEELY HOLDING GROUP  
CO., LTD.**; CN  
(220) 23/08/2022  
(511) **12 (S/D) y 37 (S/D)**  
(740) 94

(591) No reivindica colores

## LIVAN

---

(210) **541645** (540)  
(730) **Agustín Herrero**; UY  
(220) 23/08/2022  
(511) **29 (S/D)**  
(740) Dr. Manuel Albo 2746 apto. 703,  
Montevideo, 11600, Montevideo,  
Montevideo, UY

## OLMEDA ORIGENES

---

(210) **541647** (540)  
(730) **LEONELA RAGGIO**; UY  
(220) 24/08/2022  
(511) **18 (S/D)**  
(740) Si, Tarariras, , Colonia, Colonia, UY



---

(210) **541649** (540)  
(730) **GURIDAY S.A.**; UY  
(220) 24/08/2022  
(511) **19**  
(740) 186  
  
(591) -

## TRENTO

---

(210) **541650** (540)  
(730) **Kimberly-Clark Worldwide, Inc.**; US  
(220) 24/08/2022  
(511) **3 (S/D)**  
(740) 201

## **KLEENEX WATER FRESH ALLERGY COMFORT**

---

(210) **541651** (540)  
(730) **SANTIAGO EZEQUIEL SOTO SILVA**;  
UY  
(220) 24/08/2022  
(511) **24 y 35**  
(740) 192

(591) 0



---

(210) **541654** (540)  
(730) **Meta Platforms, Inc.**; US  
(220) 24/08/2022  
(511) **9 (S/D), 38 (S/D), 41 (S/D) y 45 (S/D)**  
(740) 194

## **REELS**

---

(210) **541655** (540)  
(730) **TRADETOP S.R.L.;** UY  
(220) 24/08/2022  
(511) **11**  
(740) 144

## **INDRA**

---

(210) **541659** (540)  
(730) **Mundipharma AG;** CH  
(220) 24/08/2022  
(511) **3 (S/D) y 5 (S/D)**  
(740) 144

## **BETAISODONA**

---

(210) **541661** (540)  
(730) **Venus Medtech (Hangzhou) Inc.;** CN  
(220) 24/08/2022  
(511) **10 (S/D)**  
(740) 94

## **VENUSMEDTECH**

---



(210) **541663** (540)  
(730) **Venus Medtech (Hangzhou) Inc.;** CN  
(220) 24/08/2022  
(511) **10 (S/D)**  
(740) 94

## VENUSP-VALVE

---

(210) **541664** (540)  
(730) **Venus Medtech (Hangzhou) Inc.;** CN  
(220) 24/08/2022  
(511) **10 (S/D)**  
(740) 94

## VENUSA-VALVE

---

(210) **541666** (540)  
(730) **Venus Medtech (Hangzhou) Inc.;** CN  
(220) 24/08/2022  
(511) **10 (S/D)**  
(740) 94



(210) **541667** (540)  
(730) **Venus Medtech (Hangzhou) Inc.**; CN  
(220) 24/08/2022  
(511) **10 (S/D)**  
(740) 94

## VENUSA-PRO

---

(210) **541677** (540)  
(730) **AB Mauri (UK) Limited**; GB  
(220) 24/08/2022  
(511) **1 (S/D) y 30 (S/D)**  
(740) 34

## PINNACLE

---

(210) **541678** (540)  
(730) **SEBASTIAN FERRARI**; UY  
(220) 24/08/2022  
(511) **32, 33, 35, 36, 39, 41, 43 y 44**  
(740) 223

(591) BLANCO Y VERDE



(210) **541679**  
(730) **MIGUELIFE S.A.**; UY  
(220) 24/08/2022  
(511) **43**  
(740) 34

(540)

## **SHELTER PIZZA**

---

(210) **541680**  
(730) **LABORATORIO ELEA PHOENIX S.A.**;  
AR  
(220) 24/08/2022  
(511) **3**  
(740) 34

(540)

## **INFILTREX**

---

(210) **541681**  
(730) **LABORATORIO ELEA PHOENIX S.A.**;  
AR  
(220) 24/08/2022  
(511) **10**  
(740) 34

(540)

## **INFILTREX**

---

(210) **541692** (540)  
(730) **Arla Foods Ingredients Group P/S**; DK  
(220) 24/08/2022  
(511) **1 (S/D), 5 (S/D), 29 (S/D), 30 (S/D) y 32 (S/D)**  
(740) 194



---

(210) **541693** (540)  
(730) **John Peter Sosa Chocho**; UY  
(220) 24/08/2022  
(511) **35**  
(740) 101

(591) ROJO,BLANCO

**farmaonline<sup>UY</sup>**

---

(210) **541695** (540)  
(730) **Alberico Passadore**; UY  
(220) 24/08/2022  
(511) **33**  
(740) 154

**FAMILIA PASSADORE**

---

(210) **541697** (540)  
(730) **TTS VIAJES S.A.**; AR  
(220) 26/08/2022  
(511) **39 y 43**  
(740) 28

(591) Rojo, negro.



---

(210) **541703** (540)  
(730) **Felipe Albanell**; UY  
(220) 26/08/2022  
(511) **35**  
(740) 172

(591) negro, blanco y amarillo



---

(210) **541708** (540)  
(730) **HISPA-GUAY S.A.S**; UY  
(220) 26/08/2022  
(511) **29, 32 y 39**  
(740) PANDO 2414, MONTEVIDEO, ,  
MONTEVIDEO, MONTEVIDEO, UY

(591) Rojo y amarillo



(210) **541710** (540)  
(730) **MARCELO TOCCHETTO**; UY  
(220) 26/08/2022  
(511) **19**  
(740) CARMELO 1420, MONTEVIDEO, 11700,  
MONTEVIDEO, MONTEVIDEO, UY

## PERSIPLAST

(210) **541715** (540)  
(730) **ÖZ-KA LASTIK VE KAÜÇUK SANAYI  
TICARET ANONIM SİRKETİ**; TR  
(220) 26/08/2022  
(511) **12 (S/D)**  
(740) 144

(591) Gris oscuro y Beige



(210) **541717** (540)  
(730) **ANDRÉ LUIS BORBA DA SILVA**; BR  
(220) 26/08/2022  
(511) **35 (S/D), 41 (S/D) y 44 (S/D)**  
(740) 144



(210) **541722**  
(730) **HAZUY SAS**; UY  
(220) 26/08/2022  
(511) **31, 35 y 44**  
(740) 212

(540)

## HAZIAK

---

(210) **541724**  
(730) **Mensa International Limited**; UK  
(220) 26/08/2022  
(511) **9 (S/D), 16 (S/D), 28 (S/D), 35 (S/D) y 41 (S/D)**  
(740) 212

(540)

## MENSA

---

(210) **541736**  
(730) **XFLIGHT LLC**; US  
(220) 26/08/2022  
(511) **39 y 41**  
(740) 94

(540)

(591) verde (pantone 368C), blanco, negro



XFLIGHT

---

(210) **541739** (540)  
(730) **LABORATORIO CUENCA S.A.; AR**  
(220) 26/08/2022  
(511) **3 (S/D)**  
(740) 94

## **VN BY VILLENEUVE**

---

(210) **541740** (540)  
(730) **LABORATORIO CUENCA S.A.; AR**  
(220) 26/08/2022  
(511) **3 (S/D)**  
(740) 94

(591) No reivindica colores



---

(210) **541742** (540)  
(730) **CABAL COOPERATIVA DE PROVISION  
DE SERVICIOS LIMITADA; AR**  
(220) 26/08/2022  
(511) **16, 35 y 36**  
(740) 245

## **TIENDA CABAL**

---



(210) **541747**  
(730) **Bruno Grisi**; UY  
(220) 30/08/2022  
(511) **41 (S/D)**  
(740) Av. Dr. Alfredo Navarro 3108 / 208,  
Montevideo, 11600, Montevideo,  
Montevideo, UY

(540)

## SENDEROS - RITUALES CONTEMPORÁNEOS

---

(210) **541748**  
(730) **PATAGONIA CANDLES S.R.L.**; AR  
(220) 30/08/2022  
(511) **3 (S/D)**  
(740) 189

(540)

(591) Verde, gris, rojo



---

(210) **541751**  
(730) **SOCOFAR S.A.**; CL  
(220) 30/08/2022  
(511) **3, 5, 10, 32 y 35**  
(740) 201

(540)

(591) azul, blanco y amarillo



(210) **541752** (540)  
(730) **MOSCA HNOS. S.A.**; UY  
(220) 30/08/2022  
(511) **9, 16, 35 y 36**  
(740) 192

(591) RGB HEX #FF9100;RGB HEX  
#9AEE50;RGB HEX #4AC6B7;RGB HEX  
#FF008C;RGB HEX #333970;RGB HEX  
#F0F658



---

(210) **541754** (540)  
(730) **Alberto Rodolfo Klüver Pacheco**; UY  
(220) 30/08/2022  
(511) **39**  
(740) Artigas 624, Durazno, 97000, Durazno,  
Durazno, UY

## POLO LOGÍSTICO DURAZNO

---

(210) **541756** (540)  
(730) **Nattura Laboratorios, S.A. de C.V.**; MX  
(220) 30/08/2022  
(511) **3 (S/D)**  
(740) 192

(591) 0



(210) **541766** (540)

(730) **Sebastian Osorio**; UY

(220) 30/08/2022

(511) **36**

(740) Rincón 613, Montevideo, , Montevideo,  
Montevideo, UY

(591) NEGRO Y DORADO



---

(210) **541769** (540)

(730) **ABEMOL S.A.**; UY

(220) 30/08/2022

(511) **30**

(740) 144

(591) PANTONE BLACK Y PANTONE 725



---

(210) **541770** (540)

(730) **ABEMOL S.A.**; UY

(220) 30/08/2022

(511) **43**

(740) 144

(591) PANTONE BLACK Y PANTONE 725



(210) **541786** (540)  
(730) **CAN Technologies, Inc.**; US  
(220) 30/08/2022  
(511) **1 (S/D), 5 (S/D) y 31 (S/D)**  
(740) 144

## TRUMUNE

---

(210) **541788** (540)  
(730) **Century 21 Real Estate LLC**; US  
(220) 30/08/2022  
(511) **35 (S/D) y 36 (S/D)**  
(740) 136

(591) dorado, blanco

## CENTURY 21

---

(210) **541792** (540)  
(730) **Pablo Cassarino**; UY  
(220) 30/08/2022  
(511) **9 (S/D)**  
(740) CAGANCHA 2181, Montevideo, ,  
Montevideo, Montevideo, UY

## CELUSADO

---

(210) **541793** (540)  
(730) **Beiersdorf AG**; DE  
(220) 30/08/2022  
(511) **5 (S/D)**  
(740) 136

(591) azul, blanco, amarillo, naranja, rojo



---

(210) **541794** (540)  
(730) **Beiersdorf AG**; DE  
(220) 30/08/2022  
(511) **3 (S/D)**  
(740) 136

## NIVEA MEN FRESH ICE

---

(210) **541795** (540)  
(730) **COOPERATIVA REGIONAL DE  
CAFEICULTORES EM GUAXUPÉ  
LTDA. - COOXUPÉ**; BR  
(220) 30/08/2022  
(511) **30 (S/D)**  
(740) 194

(591) -



(210) **541796** (540)  
(730) **Mallinckrodt Pharmaceuticals Ireland Limited; IE**  
(220) 30/08/2022  
(511) **5 (S/D) y 10 (S/D)**  
(740) 194

**IKARIA**

---

(210) **541803** (540)  
(730) **Center lab limitada.; UY**  
(220) 30/08/2022  
(511) **44**  
(740) 179

(591) azul, celeste y blanco.



---

(210) **541805** (540)  
(730) **Carina Antonella Minetti Pereira; UY**  
(220) 30/08/2022  
(511) **18 (S/D), 25 (S/D) y 42 (S/D)**  
(740) Roque graseras 769 Ap 501, Montevideo, ,  
Montevideo, Montevideo, UY

**MINETTI**

---

(210) **541810** (540)  
(730) **Zhejiang Chint Electrics Co., Ltd.**; CN  
(220) 30/08/2022  
(511) **9 (S/D)**  
(740) 34  
  
(591) 0



---

(210) **541815** (540)  
(730) **ILOVEDAYMAN S.A.S.**; UY  
(220) 30/08/2022  
(511) **25 (S/D)**  
(740) 212  
  
(591) NEGRO, ROJO



---

(210) **541817** (540)  
(730) **ILOVEDAYMAN S.A.S.**; UY  
(220) 30/08/2022  
(511) **14 (S/D)**  
(740) 212  
  
(591) Negro rojo



(210) **541824** (540)  
(730) **ILOVEDAYMAN S.A.S.**; UY  
(220) 30/08/2022  
(511) **20 (S/D)**  
(740) 212

(591) ROJO, NEGRO



---

(210) **541827** (540)  
(730) **ILOVEDAYMAN S.A.S.**; UY  
(220) 30/08/2022  
(511) **21 (S/D)**  
(740) 212

(591) Negro rojo



---

(210) **541829** (540)  
(730) **ILOVEDAYMAN S.A.S.**; UY  
(220) 30/08/2022  
(511) **9 (S/D)**  
(740) 212

(591) Negro rojo





(210) **541830** (540)  
(730) **VRIO CORP.**; US  
(220) 30/08/2022  
(511) **9, 38 y 41**  
(740) 218

(591) Azul, azul claro, naranja



---

(210) **541834** (540)  
(730) **Sara Belén Moyano Da Cunda**; UY  
(220) 30/08/2022  
(511) **18 (S/D) y 25 (S/D)**  
(740) VIVENDAS COVEMT II N34,  
TACUAREMBO, 45000, TACUAREMBO,  
TACUAREMBO, UY

(591) NEGRO, DORADO Y BLANCO



---

(210) **541839** (540)  
(730) **PPA URUGUAY S.R.L.**; UY  
(220) 30/08/2022  
(511) **7, 35 y 37**  
(740) 163

(591) negro, rojo, amarillo



(210) **541840** (540)  
(730) **NEWAGE INDUSTRIA DE BEBIDAS**  
**LTDA.;** BR  
(220) 30/08/2022  
(511) **32 (S/D)**  
(740) 168

(591) NEGRO – GRIS – AMARILLO – DORADO  
- BLANCO



(210) **541848** (540)  
(730) **TELESUD S.A.;** UY  
(220) 31/08/2022  
(511) **35 y 39**  
(740) 201

(591) AZUL, VERDE, BLANCO



(210) **541849** (540)  
(730) **Virginia Chivetti;** AR  
(220) 31/08/2022  
(511) **43**  
(740) Intendente Suarez 161, Colonia, 70000,  
Colonia, Colonia, UY

**QUINTÓN ENOTURISMO**

(210) **541858** (540)  
(730) **MARIO FABIAN ANSELMO**; AR  
(220) 31/08/2022  
(511) **29, 31 y 32**  
(740) 160

(591) blanco, negro, amarillo, naranja, verde, azul,  
violeta, rojo



---

(210) **541874** (540)  
(730) **María Belén Britos Rivera y Juan  
Sebastián Bonnevaux Irazoqui**; UY  
(220) 31/08/2022  
(511) **10, 37 y 44**  
(740) 220

(591) Tonos de Violeta

---

UNGA

---

---

(210) **541877** (540)  
(730) **Leandro J. Vainberg y Fernando D.  
Vainberg**; AR  
(220) 31/08/2022  
(511) **8 y 21**  
(740) 220

---

(210) **541879** (540)  
(730) **Gustavo Rodríguez Vidal**; UY  
(220) 31/08/2022  
(511) **18, 35, 41 y 44**  
(740) Av. 8 de Octubre 4480, Montevideo, 12105,  
Montevideo, Montevideo, UY

## TODOCABALLO

---

(210) **541902** (540)  
(730) **PFIZER INC.**; US  
(220) 31/08/2022  
(511) **5 (S/D)**  
(740) 194

## ZUWIFTI

---

(210) **541907** (540)  
(730) **PFIZER INC.**; US  
(220) 31/08/2022  
(511) **5 (S/D)**  
(740) 194

## LITFULO

---

(210) **541908** (540)  
(730) **Durman Esquivel S.A.**; CR  
(220) 31/08/2022  
(511) **11 (S/D) y 19 (S/D)**  
(740) 205

(591) Blanco, Naranja (Pantone 2010C)

**DUAL FORCE**

---

(210) **541910** (540)  
(730) **German Daniel Fernandez Laborda**; UY  
(220) 31/08/2022  
(511) **38 y 41**  
(740) Rambla República del Perú 1387 Ap 904,  
Pocitos Nuevo, Montevideo, 11300,  
Montevideo, Montevideo, UY

**LA NOCHE DE LOS  
RECUERDOS**

---

(210) **541917** (540)  
(730) **APPLE INC.**; US  
(220) 31/08/2022  
(511) **9**  
(740) 245

(591) rosado, azul, gris, blanco, amarillo y verde



(210) **541920** (540)  
(730) **EMILIO MIRO SALVAT S.A;** ES  
(220) 31/08/2022  
(511) **33 (S/D)**  
(740) 34  
  
(591) 0

VERMUTS  
**MIRO**

---

### ***SOLICITUDES DE FRASES PUBLICITARIAS***

(210) **540828** (540)  
(730) **PLUSUAN, S.A.;** UY  
(220) 03/08/2022  
(511) **9 y 35**  
(740) 216

**TU CARRERA DESPEGA AQUÍ**

---

(210) **541011** (540)  
(730) **Izder Advisors S.A.;** UY  
(220) 08/08/2022  
(511) **9 y 35**  
(740) 216

**SÉ MÁS INTENSAMENTE TÚ**

---

(210) **541618** (540)  
(730) **THE COCA-COLA COMPANY**; US  
(220) 23/08/2022  
(511) **32**  
(740) 94

**ELIGE LA BOTELLA  
RETORNABLE. ELIGE  
CUIDAR EL PLANETA**

---

(210) **541922** (540)  
(730) **SUZANO S.A.**; BR  
(220) 31/08/2022  
(511) **1 (S/D), 16 (S/D) y 35 (S/D)**  
(740) 34  
  
(591) 0



---

## ***SOLICITUDES DE MARCAS DE CERTIFICACIÓN***

(210) **540642** (540)  
(730) **INSTITUT DE RECERCA I  
TECNOLOGIA AGROALIMENTARIES  
(IRTA)**; ES  
(220) 29/07/2022  
(511) **29 (S/D), 31 (S/D), 40 (S/D), 42 (S/D) y 44  
(S/D)**  
(740) 144



**RESOLUCIONES DE MARCAS, CONCEDIDAS**

<b>N° Exp</b>	<b>Resolución</b>	<b>Marca</b>	<b>Clases</b>	<b>Titular</b>	<b>Ag.</b>
470200	22/08/2022	U WINES OF URUGUAY WINE EXPORTERS ASSOCIATION (mixta)	41 (Concedida) y 33 (Concedida S/D)	Asociación de Bodegas Exportadoras de Vinos Finos del Uruguay	
475704	15/08/2022	PÁJAROS PINTADOS CORREDOR TURÍSTICO DEL RÍO URUGUAY (mixta)	43 (Concedida), 41 (Concedida), 38 (Concedida), 36 (Concedida) y 35 (Concedida)	MINISTERIO DE TURISMO	
478231	03/08/2022	TAXAM	5 (Concedida S/D)	Sulphur Mills Limited	180
478929	05/08/2022	FATBOY	20 (Concedida S/D)	Fatboy the Original B.V	18
478932	05/08/2022	LAMZAC	20 (Concedida S/D)	Fatboy the Original B.V.	18
482565	03/08/2022	IU (mixta)	38 (Concedida), 35 (Concedida), 32 (Concedida), 30 (Concedida), 29 (Concedida), 25 (Concedida), 21 (Concedida), 19 (Concedida), 11 (Concedida), 6 (Concedida), 5 (Concedida), 3 (Concedida) y 31 (Denegada)	MAXITAL S.A.	194
482769	05/08/2022	TIGERFLEX	9 (Concedida S/D)	Würth International AG	201
484177	22/08/2022	MAXAM (mixta)	12 (Concedida S/D)	SAILUN GROUP CO., LTD	94
485712	29/08/2022	PK PASHKA (mixta)	25 (Concedida) y 14 (Concedida)	ANDREA MONICA LOPEZ ALBANO y CLAUDINA CARCACIA VICARIO	
486416	16/08/2022	ODIM	21 (Concedida S/D) y 16 (Concedida)	INDÚSTRIA E COMÉRCIO ODERICH LTDA	212



N° Exp	Resolución	Marca	Clases	Titular	Ag.
			S/D)		
488737	24/08/2022	PETER INFELD (mixta)	15 (Concedida S/D)	THOMASTIK-INFELD Gesellschaft m.b.H	219
489279	03/08/2022	VILAZIC	5 (Concedida S/D)	ZODIAC INTERNATIONAL CORPORATION	227
489917	22/08/2022	ELIAN (mixta)	25 (Concedida S/D)	ELIAN INDÚSTRIA TÊXTIL LTDA.	144
491959	22/08/2022	BIEN CON LOURDES	41 (Concedida) y 38 (Concedida)	MONTE CARLO TV S.A. y MARÍA LOURDES FERRO	144
492594	16/08/2022	MINIMOB	20 (Concedida) y 35 (Denegada)	LEONARDO DARÍO VILLANUEVA CABRERA y PEDRO FRANCISCO IVO TELIZ	
492888	16/08/2022	AGS HELMETS (mixta)	9 (Concedida S/D)	AGRIBEL S.A.	
495006	16/08/2022	CROW (mixta)	25 (Concedida) y 35 (Denegada)	MARTÍN RIBERO SANCHEZ	
496581	05/08/2022	GALENA (mixta)	3 (Concedida S/D)	MAGDALENA MOLDES SARAVIA	
496768	10/08/2022	KIOTO (mixta)	12 (Concedida)	Monteverde Investment & trade ltda	201
497197	12/08/2022	LINKUS RED INTEGRAL DE SERVICIOS (mixta)	45 (Concedida), 44 (Concedida), 42 (Concedida), 41 (Concedida), 40 (Concedida), 39 (Concedida), 38 (Concedida), 37 (Concedida S/D), 36 (Concedida), 35 (Concedida S/D), 35 (Concedida) y 9 (Denegada)	Porto Servicios y Comercio S.A.	94
497674	03/08/2022	IMACO TE HACE LA VIDA FÁCIL (mixta)	21 (Concedida), 11 (Concedida), 10 (Concedida S/D), 9 (Concedida), 8 (Concedida) y 7 (Concedida)	INVERSIONES MUB S.A.C.	94
498905	15/08/2022	CARTER	21 (Concedida S/D)	MARCAL IMPORTACIONES S.R.L.	212

<b>N° Exp</b>	<b>Resolución</b>	<b>Marca</b>	<b>Clases</b>	<b>Titular</b>	<b>Ag.</b>
499540	26/08/2022	SWEET BABY RAY'S GOURMET SAUCES (mixta)	30 (Concedida S/D)	Ken's Foods, Inc	34
499559	10/08/2022	TITA	30 (Concedida)	SILVANA AGRASO OUNDJIAN	179
499611	03/08/2022	KOZ BAZAR GOURMET (mixta)	35 (Concedida), 28 (Concedida), 27 (Concedida), 24 (Concedida), 21 (Concedida), 20 (Concedida), 18 (Concedida), 14 (Concedida), 9 (Concedida) y 8 (Concedida)	Macfisan SA.	212
499731	26/08/2022	HEPATOXAN	5 (Concedida S/D)	Vallee S.A.	216
499782	26/08/2022	KING MIX (mixta)	30 (Concedida S/D)	BRAVEN FOODS LTDA.	201
499978	03/08/2022	LINEA VERDE (mixta)	16 (Concedida)	Nolamir S.A.	144
499999	26/08/2022	DUPE	25 (Concedida)	ALPARGATAS S.A.	201
500535	22/08/2022	A+A ARSAMICI (mixta)	43 (Concedida) y 41 (Concedida)	Agustin PRAT GUTIERREZ	52
500538	10/08/2022	BALMAIN (mixta)	35 (Concedida), 25 (Concedida), 18 (Concedida), 14 (Concedida S/D) y 9 (Concedida)	PIERRE BALMAIN S.A.S.	201
501261	26/08/2022	SPIOLTO RESPIMAT (mixta)	5 (Concedida S/D)	Boehringer Ingelheim International GmbH	136
501267	26/08/2022	CASINO QUEEN	28 (Concedida S/D) y 9 (Denegada S/D)	adp Gauselmann GmbH	240
501459	10/08/2022	LUIS FELIPE EDWARDS	33 (Concedida S/D)	Viña Luis Felipe Edwards Ltda.	144
502040	24/08/2022	MILAGRO	33 (Concedida)	Tequilera Milagro, S.A. de C.V.	165
502160	15/08/2022	URBAN HERO	3 (Concedida S/D)	J.CHOO LIMITED	194
502180	15/08/2022	LA ROMANA (mixta)	35 (Concedida) y 25	CELIA HODJAIAN PRESENTA	228

N° Exp	Resolución	Marca	Clases	Titular	Ag.
			(Concedida)		
502428	16/08/2022	FRUTASUL (mixta)	30 (Concedida) y 29 (Denegada)	MARIZA INDUSTRIA E COMERCIO DE ALIMENTOS LTDA	34
502911	10/08/2022	FORUM URUGUAY CONGRESS AND EXHIBITION CENTER	41 (Concedida)	CERIPEN TRADE S.A.	201
503180	19/08/2022	NOLAZOL	5 (Concedida S/D)	NLS Pharmaceuticals AG	136
503716	16/08/2022	BURGER POINT	43 (Concedida S/D)	Johnny Walker	
503734	29/08/2022	RUSSOMANDO (mixta)	44 (Concedida) y 39 (Concedida)	RUSSOMANDO ABBATE, IVES WASHINGTON	189
503799	16/08/2022	LA GUARDIA VIEJA	41 (Concedida)	Sebastián Custiel	
503865	05/08/2022	BABY SHARK	28 (Concedida)	Smart Study Co., Ltd.	201
504119	05/08/2022	BABY SHARK (mixta)	28 (Concedida)	Smart Study Co., Ltd.	201
504265	10/08/2022	CARDIUM	5 (Concedida)	MEGALABS URUGUAY S.A.	144
504267	10/08/2022	CARDIUM D	5 (Concedida)	MEGALABS URUGUAY S.A.	144
504729	15/08/2022	YELLOW ROSE	33 (Concedida S/D)	Yellow Rose Distilling, LLC	
504970	15/08/2022	OH! LA BARRA (mixta)	9 (Concedida S/D)	NETZAJ S.A.	201
505802	15/08/2022	SANTIAGO DEICAS VINO BIZARRA	33 (Concedida S/D)	ESTABLECIMIENTO JUANICO S.A.	201
506070	15/08/2022	SULFOSATO TOUCHDOWN	5 (Concedida S/D)	SYNGENTA CROP PROTECTION, LLC	194
506634	05/08/2022	ANA MARIA LAJUSTICIA (mixta)	5 (Concedida S/D)	DISTRIBUCIONES FELIU, S.L.	94
507352	05/08/2022	INTERNATIONAL FEDERATION OF KARATE KYOKUSHIN (mixta)	41 (Concedida S/D) y 25 (Concedida S/D)	Pablo Germán Carballo Barbieri	
507500	29/08/2022	EMBOLOG	5 (Concedida S/D)	SERUMWERK BERNBURG AG	201
507573	29/08/2022	EXESO	14 (Concedida S/D)	Ximena Bentancor	
507596	29/08/2022	LOGÍSTICA HORIZONTE	39 (Concedida S/D)	PEDRO ALFONSO LIMITADA	37
507843	29/08/2022	MOTIVATION LUXURY SUMMIT BY FIEXPO EXHIBITIONS THE LATIN AMERICAN INCENTIVE & LUXURY EXPERIENCE (mixta)	41 (Concedida S/D)	FIEXPO INTERNATIONAL EXHIBITION GROUP LTDA.	101
507951	29/08/2022	EL CEIBO	33 (Concedida)	CENTRO VITIS LTDA.	201

<b>N° Exp</b>	<b>Resolución</b>	<b>Marca</b>	<b>Clases</b>	<b>Titular</b>	<b>Ag.</b>
508227	29/08/2022	FÚTBOL PING PONG (mixta)	28 (Concedida S/D)	Juan Manuel Olivera López	
508275	29/08/2022	NATURAL MENTE	3 (Concedida S/D)	Jimena Castells	
508277	29/08/2022	AGUILA	33 (Concedida) y 32 (Concedida)	GRISEDU SRL	28
508285	29/08/2022	YAHOO! (mixta)	45 (Concedida), 42 (Concedida), 41 (Concedida), 38 (Concedida), 36 (Concedida), 35 (Concedida) y 9 (Concedida)	Yahoo Inc.	136
508287	29/08/2022	PICO DE AGUILA	33 (Concedida) y 32 (Concedida)	GRISEDU SRL	28
508291	29/08/2022	AGUILA DEL PLATA	33 (Concedida) y 32 (Concedida)	GRISEDU SRL	28
508319	29/08/2022	ICLUM	5 (Concedida)	Mega Labs S.A.	144
508320	29/08/2022	NORFINE	5 (Concedida)	Mega Labs S.A.	144
508389	29/08/2022	CEB CENTRO DE ESTUDIOS BIOQUIMICOS	44 (Concedida)	Ana Carolina Command	232
508882	10/08/2022	VERSASWEET	1 (Concedida S/D)	Corn Products Development, Inc.	194
508894	10/08/2022	LIMPIOLUX FACILITY SERVICES (mixta)	37 (Concedida)	LIMPIOLUX S.A.	201
511408	16/08/2022	TARTARIA SMART CITIES (mixta)	41 (Concedida) y 35 (Concedida)	MARIA VERONICA BRUN AVILA y MARIA VALERIA CUEVAS CASTRO	168
515708	11/08/2022	VILMORIN DEPUIS 1743 (mixta)	31 (Concedida S/D)	VILMORIN-MIKADO	144
517058	08/08/2022	BAYER BAYER (mixta)	44 (Concedida S/D), 42 (Concedida S/D), 41 (Concedida S/D), 35 (Concedida S/D), 31 (Concedida S/D), 10 (Concedida S/D),	Bayer Aktiengesellschaft	218

N° Exp	Resolución	Marca	Clases	Titular	Ag.
			9 (Concedida S/D), 5 (Concedida S/D), 3 (Concedida S/D) y 1 (Concedida S/D)		
517463	11/08/2022	MOLONA (mixta)	35 (Concedida S/D)	mariana pellejero	
517497	18/08/2022	HIPOALERGIC RIASA SRL, (mixta)	5 (Concedida)	RIASA S.R.L	234
517603	08/08/2022	ÁTICO	20 (Concedida)	Paula Domínguez Menes	
517719	29/08/2022	BIOESTIMULACIÓN (mixta)	44 (Concedida)	CENTISUR SA	
517773	08/08/2022	SYNGENTA GROUP (mixta)	44 (Concedida S/D), 42 (Concedida S/D), 31 (Concedida S/D), 16 (Concedida S/D), 5 (Concedida S/D) y 1 (Concedida S/D)	SYNGENTA PARTICIPATIONS AG	194
517779	16/08/2022	KINGHOME	11 (Concedida S/D), 9 (Concedida S/D) y 7 (Concedida S/D)	GREE ELECTRIC APPLIANCES, INC. OF ZHUHAI	144
517780	16/08/2022	KINGHOME (mixta)	11 (Concedida S/D), 9 (Concedida S/D) y 7 (Concedida S/D)	GREE ELECTRIC APPLIANCES, INC. OF ZHUHAI	144
517796	18/08/2022	P PEDERNAL GESTIÓN INTEGRAL DE RESIDUOS (mixta)	40 (Concedida S/D), 35 (Concedida) y 7 (Concedida S/D)	DEPOSITO PEDERNAL S.A.	94
517948	16/08/2022	3 TRES MEDALLAS SANTA RITA	33 (Concedida S/D)	SOCIEDAD ANONIMA VIÑA SANTA RITA	34
517951	29/08/2022	MULTIVENTAS R (mixta)	35 (Concedida)	ODILE FREDERICK	144
517990	29/08/2022	BRUNA (mixta)	33 (Concedida) y 31 (Concedida)	Viriginia Chivetti	
518021	08/08/2022	FRIOKUBO (mixta)	43 (Concedida), 35 (Concedida), 31 (Concedida) y 29 (Concedida)	TIOMA S.A.	101

N° Exp	Resolución	Marca	Clases	Titular	Ag.
518117	12/08/2022	HARD FRESH HARD SELTZER (mixta)	33 (Concedida S/D)	Compañía Pisquera de Chile S.A.	18
518188	11/08/2022	RUSTIKAS.UY	31 (Concedida S/D)	Alfonso Grela	
518191	12/08/2022	VIGNERON (mixta)	33 (Concedida S/D)	BODEGA LAGUNA DE ROCHA	
518192	12/08/2022	BASIC	33 (Concedida S/D) y 32 (Concedida S/D)	Basic Holdco LLC	194
518196	12/08/2022	BASICO	33 (Concedida S/D) y 32 (Concedida S/D)	Basic Holdco LLC	194
518243	18/08/2022	AUSTERO	33 (Concedida)	Nicolás Bonora	
518262	11/08/2022	(sonora)	9 (Concedida S/D)	Nokia Corporation	18
518314	08/08/2022	SACRO	33 (Concedida S/D), 32 (Concedida S/D) y 31 (Concedida S/D)	Rosina Kiriakidis	
518376	29/08/2022	CP (mixta)	39 (Concedida S/D) y 35 (Concedida S/D)	CARLOS PATRON S.A. y Juan Carlos Patrón Rocci	
518553	18/08/2022	WORLD MOSQUITO PROGRAM (mixta)	45 (Concedida S/D), 44 (Concedida S/D), 42 (Concedida S/D) y 31 (Concedida S/D)	Monash University	94
518567	18/08/2022	FLOR DE JUAN LOPEZ (mixta)	34 (Concedida S/D)	CORPORACION HABANOS, S.A.	144
518569	16/08/2022	EVO SURFBOARDS	28 (Concedida S/D)	Javier aguirre	
518586	19/08/2022	LAHUSEN	33 (Concedida)	SENFOR S.A.	201
518605	11/08/2022	OR.GA.NI.CO GREENHOUSE (mixta)	31 (Concedida S/D)	ANA LAURA SOSA MOLINA y JORGE MARTINEZ BRIGATTI	
518671	11/08/2022	VERTIX	31 (Concedida S/D)	Advanta Holdings BV	144
518674	11/08/2022	VERTIX (mixta)	31 (Concedida S/D)	Advanta Holdings BV	144

<b>N° Exp</b>	<b>Resolución</b>	<b>Marca</b>	<b>Clases</b>	<b>Titular</b>	<b>Ag.</b>
518813	10/08/2022	BRANGUS LA RAZA FUERTE PRODUZCA MAS TERNEROS WWW.BRANGUS.ORG.UY (mixta)	31 (Concedida) y 29 (Concedida)	ASOCIACION RURAL DEL URUGUAY	34
518814	08/08/2022	ULTRABLACK ULTRARED BRANGUS (mixta)	31 (Concedida) y 29 (Concedida)	ASOCIACION RURAL DEL URUGUAY	34
518912	11/08/2022	WORKPLACE REAL ESTATE (mixta)	36 (Concedida S/D) y 35 (Concedida S/D)	Gerardo Viñoles y Agustín Pintos	
518920	08/08/2022	EXQUISITOS CALIDAD QUE ALIMENTA (mixta)	31 (Concedida)	Pro & Food Arg S.A.	212
518922	08/08/2022	TROCITOS ELLOS LO ELIGEN (mixta)	31 (Concedida)	Pro & Food Arg S.A.	212
519028	18/08/2022	SER SUSTAINABLE EQUITABLE REALITY (mixta)	45 (Concedida), 42 (Concedida) y 35 (Concedida)	MARTA GABRIELA MICHETTI, y MARINA KLEMENSIEWICZ	233
519112	19/08/2022	VITERRA (mixta)	44 (Concedida S/D), 42 (Concedida S/D), 40 (Concedida S/D), 39 (Concedida S/D), 36 (Concedida S/D), 35 (Concedida S/D), 31 (Concedida S/D), 30 (Concedida S/D), 29 (Concedida S/D), 22 (Concedida S/D), 5 (Concedida S/D) y 1 (Concedida S/D)	Viterra Canada Inc.	34
519115	19/08/2022	VITERRA THE AGRICULTURE NETWORK (mixta)	44 (Concedida S/D), 42 (Concedida S/D), 40 (Concedida S/D), 39 (Concedida S/D),	Viterra Canada Inc.	34

N° Exp	Resolución	Marca	Clases	Titular	Ag.
			36 (Concedida S/D), 35 (Concedida S/D), 31 (Concedida S/D), 30 (Concedida S/D), 29 (Concedida S/D), 22 (Concedida S/D), 5 (Concedida S/D) y 1 (Concedida S/D)		
519116	19/08/2022	V (mixta)	44 (Concedida S/D), 42 (Concedida S/D), 40 (Concedida S/D), 39 (Concedida S/D), 36 (Concedida S/D), 35 (Concedida S/D), 31 (Concedida S/D), 30 (Concedida S/D), 29 (Concedida S/D), 22 (Concedida S/D), 5 (Concedida S/D) y 1 (Concedida S/D)	Viterra Canada Inc.	34
519184	19/08/2022	BEEPURE NATURALMENTE ALIMENTOS (mixta)	35 (Concedida), 33 (Concedida), 32 (Concedida), 30 (Concedida) y 29 (Concedida)	NATURALMENTE ALIMENTOS S.A.	194
519249	08/08/2022	EL TELEGRAFO (mixta)	31 (Concedida)	AGROPECUARIA EL TELEGRAFO S.A.	118
519284	18/08/2022	1950 LABS (mixta)	42 (Concedida S/D)	DEXACTA S.A.	201
519306	18/08/2022	PEDIGREE (mixta)	31 (Concedida S/D)	Mars, Incorporated	18
519307	19/08/2022	PEDIGREE (mixta)	31 (Concedida S/D)	Mars, Incorporated	18
519309	19/08/2022	PEDIGREE (mixta)	31 (Concedida S/D)	Mars, Incorporated	18
519310	19/08/2022	WHISKAS (mixta)	31 (Concedida S/D)	Mars, Incorporated	18



N° Exp	Resolución	Marca	Clases	Titular	Ag.
519311	19/08/2022	WHISKAS (mixta)	31 (Concedida S/D)	Mars, Incorporated	18
519312	19/08/2022	WHISKAS (mixta)	31 (Concedida S/D)	Mars, Incorporated	18
519371	19/08/2022	DUO (mixta)	31 (Concedida)	Mapatex S.A.	212
519433	10/08/2022	D.I.S. DESARROLLOS INDUSTRIALES SUSTENTABLES (mixta)	37 (Concedida S/D), 36 (Concedida S/D) y 35 (Concedida S/D)	OCTAVIO FERNANDO ACERBO	186
519486	11/08/2022	PROFIGEN BRASIL (mixta)	34 (Concedida S/D) y 31 (Concedida S/D)	Profigen LLC	201
519494	11/08/2022	HARDEN (mixta)	8 (Concedida) y 7 (Concedida)	SHANGHAI HARDEN TOOLS CO. LTD.	28
519514	18/08/2022	BODEGAS DE LA BALLENA	43 (Concedida), 35 (Concedida) y 33 (Concedida)	MANUEL ROMERO PASMAN	101
519529	08/08/2022	SIGMA INVESTMENT HOUSE (mixta)	36 (Concedida S/D)	ANDORRA BANC AGRICOL REIG, S.A.	181
519581	18/08/2022	ROOSTER VERMOUTH (mixta)	33 (Concedida)	Antonella Borroni	
519602	19/08/2022	BODEGA DANTE ROBINO (mixta)	33 (Concedida S/D)	Bodega Dante Robino S.A.,	144
519627	18/08/2022	PETRA	33 (Concedida)	Nicolas Estefan	172
519655	18/08/2022	BRISAS DE MAR	33 (Concedida)	AGROLAND S.A.	216
519744	22/08/2022	ALTUS (mixta)	33 (Concedida S/D) y 29 (Concedida S/D)	Ladwer Corporation S.A.	
519800	08/08/2022	FARMAX GGT	31 (Concedida S/D), 5 (Concedida S/D) y 1 (Concedida S/D)	Beijing DaBeiNong Biotechnology Co., Ltd.	34
519846	08/08/2022	FLEISCHSAFTGARUNG	31 (Concedida S/D)	Platinum GmbH & Co. KG	34
519864	08/08/2022	MIKATUA	31 (Concedida)	Marilyn Yosmar Mora Molina	52
519867	08/08/2022	TIMAC AGRO (mixta)	31 (Concedida S/D), 5 (Concedida S/D) y	COMPAGNIE FINANCIERE ET DE PARTICIPATIONS ROULLIER	144

N° Exp	Resolución	Marca	Clases	Titular	Ag.
			1 (Concedida S/D)		
519868	09/08/2022	JENOVA ELEGANCIA Y ESTILO (mixta)	35 (Concedida) y 25 (Concedida)	GONZALEZ PIREZ MARIA FLORENCIA	144
519966	10/08/2022	SWIPE NIGHT	45 (Concedida S/D), 41 (Concedida S/D) y 9 (Concedida S/D)	Match Group, LLC	216
520027	22/08/2022	HARD ROCK DIGITAL	41 (Concedida) y 9 (Concedida)	Hard Rock Limited	179
520028	22/08/2022	HARD ROCK BET	41 (Concedida) y 9 (Concedida)	Hard Rock Limited	179
520029	22/08/2022	HARD ROCK DIGITAL (mixta)	41 (Concedida) y 9 (Concedida)	Hard Rock Limited	179
520030	22/08/2022	HARD ROCK BET (mixta)	41 (Concedida) y 9 (Concedida)	Hard Rock Limited	179
520046	16/08/2022	URUPORK	44 (Concedida), 40 (Concedida), 35 (Concedida), 31 (Concedida) y 29 (Concedida)	VICTOR JULIO GARCIA PAULLIER	194
520061	16/08/2022	URU WAY (mixta)	45 (Concedida), 38 (Concedida) y 36 (Concedida)	Pro Vista Uruguay SAS	144
520071	16/08/2022	LIMONCELLO NOSTRANO (mixta)	33 (Concedida S/D) y 29 (Concedida S/D)	Juan Diego Scheck	189
520083	29/08/2022	SUDANFER HELADERÍA (mixta)	43 (Concedida S/D) y 30 (Concedida)	Marcelo Alejandro de Oliveira Madeira y Analía De Oliveira Madeira	222
520091	08/08/2022	E-TOWER	36 (Concedida) y 35 (Concedida)	Eduardo Campiglia Larre	
520159	08/08/2022	UYU WAGYU BEEF (mixta)	29 (Concedida S/D)	AGROMEALS S.A.	194
520234	08/08/2022	(figurativa)	44 (Concedida S/D),	Ulthera, Inc.	144

N° Exp	Resolución	Marca	Clases	Titular	Ag.
			41 (Concedida S/D), 16 (Concedida S/D), 10 (Concedida S/D) y 9 (Concedida S/D)		
520259	29/08/2022	DESTILERIA LIBERTAD	33 (Concedida S/D)	Nicolas Badel Mora	
520260	29/08/2022	GIN LIBERTAD URUGUAY DRY GIN (mixta)	33 (Concedida S/D)	Nicolas Badel Mora	
520303	18/08/2022	VALDUERO	33 (Concedida S/D)	EXPLOTACIONES VALDUERO S.A.	144
520308	19/08/2022	FINCA AZAYA (mixta)	33 (Concedida S/D)	EXPLOTACIONES VALDUERO S.A.	144
520329	19/08/2022	BRACCOBOSCA	35 (Concedida) y 33 (Concedida)	BRACCO, FABIANA	201
520331	19/08/2022	GRACIAS NEGRITO	33 (Concedida)	SILVINA EUGENIA ROSAS LABANDERA	101
520486	19/08/2022	MIJA	33 (Concedida)	Silvina Eugenia Rosas Labandera	101
520657	08/08/2022	LA CASITA SUSHI BAR (mixta)	43 (Concedida S/D)	BERMUDEZ FIGUEIRA, SEBASTIAN Y PINTOS PUCURULL, ALEJANDRO MARTIN-SOCIEDAD DE HECHO	201
520672	19/08/2022	ARYA	33 (Concedida)	SAAC LTDA	
520676	08/08/2022	MEATLESS FARM (mixta)	29 (Concedida S/D)	The Meatless Farm Limited	136
520714	09/08/2022	G (mixta)	30 (Concedida S/D), 5 (Concedida S/D), 3 (Concedida S/D), 2 (Concedida S/D) y 1 (Concedida S/D)	Givaudan SA	201
520797	09/08/2022	MINNIE LANNDIE	41 (Concedida)	ADRIANA BERMÚDEZ	
520834	08/08/2022	VICEROY (mixta)	34 (Concedida S/D)	British American Tobacco (Brands) Inc.	194
520847	18/08/2022	OA ORGANICA DE LAS ANIMAS (mixta)	33 (Concedida), 32 (Concedida), 30 (Concedida) y 29 (Concedida)	PREMIUMBEVS S.A.	212
520879	08/08/2022	(figurativa)	3 (Concedida S/D)	PUIG FRANCE, Société par Actions Simplifiée	245
520883	18/08/2022	BANDERA (mixta)	33 (Concedida S/D)	INVERSIONES CDE, CA	212

<b>N° Exp</b>	<b>Resolución</b>	<b>Marca</b>	<b>Clases</b>	<b>Titular</b>	<b>Ag.</b>
520891	19/08/2022	TA BUENO!	33 (Concedida)	STAGNARI MOISE, HECTOR MARIANO	201
520947	15/08/2022	FOLIUM CAPITAL	36 (Concedida S/D)	Folium Capital LP	194
520973	08/08/2022	STEREO (mixta)	45 (Concedida S/D), 42 (Concedida S/D), 38 (Concedida S/D), 35 (Concedida S/D), 25 (Concedida S/D) y 9 (Concedida S/D)	Stereo App Limited	136
520978	19/08/2022	AGRESTE	43 (Concedida), 36 (Concedida) y 33 (Concedida)	PARAJE LINDO S.A.	136
520995	08/08/2022	PUNTO MIO TM (mixta)	39 (Concedida), 38 (Concedida) y 35 (Concedida)	SKYPOSTAL INC.	144
521014	10/08/2022	RIKKO BARES MODERNOS (mixta)	43 (Concedida S/D), 39 (Concedida) y 35 (Concedida)	BARES MODERNOS S.A.S.	189
521019	10/08/2022	TELIZZIA CAT CAFÉ (mixta)	43 (Concedida S/D) y 30 (Concedida S/D)	TELIZ SOSA MARTINA Y COMESAÑA OUTEDA MATIAS SOCIEDAD DE HECHO	
521026	10/08/2022	SALTY GIRLS	41 (Concedida), 39 (Concedida) y 25 (Concedida)	Agustina Brum y Camila Meana	194
521040	10/08/2022	SAJÚ R (mixta)	9 (Concedida S/D)	La Familia del Mono S.A.S.	144
521042	10/08/2022	LE 8 D'HYPNOSE	3 (Concedida S/D)	L'OREAL	144
521053	10/08/2022	FLOR DE KAFFEE (mixta)	43 (Concedida S/D)	Florencia Brignoni Sacchi	220
521067	10/08/2022	EL BOTERO (mixta)	43 (Concedida)	FIDEICOMISO 53171	194
521069	10/08/2022	FLORALIFE (mixta)	5 (Concedida)	LAKINOR S.A.	34
521070	10/08/2022	CASAREDO TEA COOKIES (mixta)	30 (Concedida S/D)	NUTRISUL SA PRODUTOS ALIMENTÍCIOS	34
521071	10/08/2022	YUPI (mixta)	30 (Concedida)	NUTRISUL SA PRODUTOS ALIMENTÍCIOS	34
521073	11/08/2022	COMUNIDAD PLUS (mixta)	36 (Concedida) y 35	TA -TA S.A.	245

N° Exp	Resolución	Marca	Clases	Titular	Ag.
			(Concedida)		
521074	10/08/2022	CABRIOLE	3 (Concedida S/D)	COMPTOIR NOUVEAU DE LA PARFUMERIE	245
521075	10/08/2022	IN HER OVEN (mixta)	30 (Concedida S/D)	Luisina Papa	
521076	10/08/2022	BURSA GUARD	5 (Concedida S/D)	BOEHRINGER INGELHEIM ANIMAL HEALTH FRANCE	245
521077	10/08/2022	IC INFORME CAPITAL (mixta)	41 (Concedida) y 38 (Concedida)	INTENDENCIA DE MONTEVIDEO	212
521078	10/08/2022	LOS COMPAS	16 (Concedida S/D)	EDITORIAL PLANETA, S.A.	212
521079	10/08/2022	AGUA JANE EXPERT	5 (Concedida S/D)	THE CLOROX INTERNATIONAL COMPANY	228
521080	10/08/2022	MUEBLES PECOS (mixta)	20 (Concedida S/D)	Grupo Walder Rodriguez, S.R.L.	
521081	10/08/2022	RODEO SANO (mixta)	44 (Concedida S/D) y 35 (Concedida S/D)	Santiago Sánchez Pradere	
521083	10/08/2022	REQUESO PIZZERIA (mixta)	43 (Concedida)	BUITRAGO DIAZ MARIANA	220
521085	10/08/2022	DR. PIEL	5 (Concedida) y 3 (Concedida)	REMOBAR S.A.	160
521089	10/08/2022	BALEK (mixta)	35 (Concedida), 25 (Concedida) y 12 (Concedida)	Diego Jamen	
521092	10/08/2022	GULA (mixta)	38 (Concedida) y 35 (Concedida)	Martín Fernández y Marcell Calero	179
521096	11/08/2022	CRAFT ICE	11 (Concedida S/D)	LG ELECTRONICS INC.	201
521149	18/08/2022	MÁS SALUD (mixta)	44 (Concedida S/D)	COBOE S.A.	212
521151	19/08/2022	GIMENEZ MENDEZ (mixta)	33 (Concedida)	GIMENEZ MENDEZ S.R.L.	220
521193	10/08/2022	ENDO CLINICA	44 (Concedida S/D)	ENDO-CLÍNICA	154
521194	19/08/2022	LATITA WINES (mixta)	33 (Concedida S/D)	Trabazo Reñones Alejandra	
521225	16/08/2022	WOVEN CITY	42 (Concedida S/D) y 39 (Concedida S/D)	TOYOTA JIDOSHA KABUSHIKI KAISHA (also trading as TOYOTA MOTOR CORPORATION)	94
521226	18/08/2022	(figurativa)	42 (Concedida S/D) y 39 (Concedida)	TOYOTA JIDOSHA KABUSHIKI KAISHA (also trading as TOYOTA MOTOR)	94

N° Exp	Resolución	Marca	Clases	Titular	Ag.
			S/D)	CORPORATION)	
521240	16/08/2022	QUEIJOSDELESTE	29 (Concedida S/D)	LACURCIA ARREGUI IGNACIO Y GALLINAL VEPO FRANCISCO SOCIEDAD DE HECHO	
521253	08/08/2022	LA CHINGADA CANTINA	43 (Concedida)	COZZA PSARRAS, GUILLERMO	201
521269	08/08/2022	LEAGUE OF LEGENDS: WILD RIFT	41 (Concedida S/D) y 38 (Concedida S/D)	Riot Games, Inc.	136
521283	16/08/2022	GREENMAN NEGOCIOS INMOBILIARIOS (mixta)	36 (Concedida S/D)	GORONDONA CONSTANTINO, GABRIEL ALFREDO	201
521319	18/08/2022	EDÉN CONCEPT	44 (Concedida S/D), 43 (Concedida S/D), 35 (Concedida S/D) y 33 (Concedida S/D)	VIÑA EDÉN SA	
521337	08/08/2022	STERILEX (mixta)	5 (Concedida S/D)	Sterilex LLC	34
521378	18/08/2022	1932 MILNOVECIENTOSTREINTAYDOS (mixta)	33 (Concedida)	CENTRO DE VITICULTORES DEL URUGUAY ASOCIACIÓN CIVIL	194
521382	22/08/2022	CENTRO DE VITICULTORES URUGUAY (mixta)	41 (Concedida), 35 (Concedida) y 33 (Concedida)	CENTRO DE VITICULTORES DEL URUGUAY ASOCIACIÓN CIVIL	194
521386	08/08/2022	MVD SMILE ESTÉTICA & ODONTOLOGÍA (mixta)	44 (Concedida S/D)	Natalia Echeverría	181
521388	19/08/2022	PALL MALL (mixta)	34 (Concedida S/D)	British American Tobacco (Brands) Inc.	194
521420	09/08/2022	GB GB THE GREEN BRAND (mixta)	35 (Concedida)	ERCOVI GROUP MANAGEMENT S.L.	28
521425	08/08/2022	LURPAK ESTD 1901 (mixta)	29 (Concedida S/D)	Arla Foods amba	194
521430	08/08/2022	ROTOPLAS MÁS Y MEJOR AGUA (mixta)	37 (Concedida S/D)	GRUPO ROTOPLAS S.A.B. DE C.V.	245
521446	08/08/2022	OMNIA K-HUMATE	1 (Concedida S/D)	OMNIA HOLDINGS LIMITED	201
521447	08/08/2022	FERTICOAT	5 (Concedida S/D) y	OMNIA HOLDINGS LIMITED	201

N° Exp	Resolución	Marca	Clases	Titular	Ag.
			1 (Concedida S/D)		
521448	08/08/2022	HUMAKELP	1 (Concedida S/D)	OMNIA HOLDINGS LIMITED	201
521450	08/08/2022	OMNIA K-FULVATE	1 (Concedida S/D)	OMNIA HOLDINGS LIMITED	201
521453	08/08/2022	LA ESKINA DE LA GOMA (mixta)	35 (Concedida), 17 (Concedida), 12 (Concedida) y 7 (Concedida)	RUBEN DARIO CARABAJAL LARROSA	144
521472	08/08/2022	PLURALIS MICE (mixta)	41 (Concedida) y 39 (Concedida)	Silvia Alejandra Guerrero	172
521495	08/08/2022	UMBILIX	5 (Concedida S/D)	LABORATORIO GADOR S.A.	165
521571	10/08/2022	BE JUICE (mixta)	32 (Concedida S/D)	Valentina Fernández Aristov	186
521594	08/08/2022	AIRBRICK (mixta)	35 (Concedida) y 19 (Concedida)	Tecilor S.A.	
521612	11/08/2022	YACHT CLUB PUNTA DEL ESTE (mixta)	43 (Concedida), 41 (Concedida) y 25 (Concedida)	YACHT CLUB PUNTA DEL ESTE	52
521618	08/08/2022	QUESERIA ARTESANAL D'HERMANOS 2001 (mixta)	25 (Concedida)	OLIVER MARTINEZ PABLO JOSE, OLIVER MARTINEZ MARCOS MANUEL Y OTROS SOCIEDAD DE HECHO	220
521631	08/08/2022	BLUEPROP TRANSACCIONES INMOBILIARIAS (mixta)	36 (Concedida S/D)	SERGIO DANIEL SAPONARI RIORTORTO	
521633	18/08/2022	CUATRO VIENTOS CARNE GRAN RESERVA EST. 1810 N E S W PAYSANDÚ URUGUAY (mixta)	35 (Concedida) y 29 (Concedida S/D)	FRIGORIFICO CASA BLANCA S.A.	201
521642	08/08/2022	OPINIONES SA OPINIONES SIN ATADURAS (mixta)	41 (Concedida) y 38 (Concedida)	GARRETANO MACRI FABRIZIO ANDRES	220
521653	08/08/2022	CONSTRUCTIVAS, MUJERES EN CONSTRUCCIÓN (mixta)	41 (Concedida) y 37 (Concedida)	María Fernanda Stiffano Cervino	
521658	18/08/2022	KÖMET (mixta)	35 (Concedida) y 25 (Concedida)	UNILAM S.A	212
521674	08/08/2022	CASA MARA SIERRA & MAR (mixta)	43 (Concedida)	VITONOR S.A.	94

N° Exp	Resolución	Marca	Clases	Titular	Ag.
521678	08/08/2022	DIU DROGUERÍA INDUSTRIAL URUGUAYA EMILIO BENZO S.A. (mixta)	35 (Concedida), 5 (Concedida), 4 (Concedida), 3 (Concedida) y 1 (Concedida)	EMILIO BENZO S.A.	194
521684	08/08/2022	TROPICAL REPLACEMENT PANEL	19 (Concedida S/D)	URUPLY S.A.	218
521685	08/08/2022	FASHION NOVA	35 (Concedida S/D), 25 (Concedida S/D), 18 (Concedida S/D), 14 (Concedida S/D) y 9 (Concedida S/D)	Fashion Nova, LLC	194
521698	08/08/2022	MGM MICROELECTRÓNICA (mixta)	37 (Concedida S/D)	Martin Gerardo Maquiolo Peixoto	
521699	08/08/2022	TUKU TUKU (mixta)	30 (Concedida)	FATIMA MARIA TUBEROSO GRILLI	212
521732	29/08/2022	MONICA C Y SUS AMIGOS MAURÍCIO (mixta)	41 (Concedida S/D) y 16 (Concedida S/D)	Maurício de Sousa Produções S.A.	245
521743	08/08/2022	AMP AMO MIS PESTAÑAS	35 (Concedida) y 3 (Concedida)	MARQUEZ, PAOLA	189
521744	08/08/2022	LA PALOMA BREWING COMPANY (mixta)	43 (Concedida) y 32 (Concedida)	Nicolas Mascheroni	
521745	08/08/2022	SINTALC SUPER RESISTENTES (mixta)	21 (Concedida) y 9 (Concedida)	ZITAN S.A.	104
521746	08/08/2022	GABAÓN (mixta)	3 (Concedida S/D)	ARAMI YERUTI SU KIM	189
521747	08/08/2022	GABAÓN (mixta)	35 (Concedida S/D)	ARAMI YERUTI SU KIM	189
521749	08/08/2022	OUR LIFE SKATEBOARDS	28 (Concedida S/D)	Meghan McCubbin	
521752	08/08/2022	CREART LEARNING THROUGH ART (mixta)	41 (Concedida)	Analía Luzardo	234
521758	08/08/2022	XINGDA (mixta)	6 (Concedida S/D)	JIANGSU XINGDA STEEL TYRE CORD CO., LTD.	201
521759	08/08/2022	BUSCANDO A TOBI (mixta)	42 (Concedida)	Daniel Monza	
521761	08/08/2022	CHROMECAST	9 (Concedida S/D)	Google LLC	194



N° Exp	Resolución	Marca	Clases	Titular	Ag.
521763	08/08/2022	NOFF NO FIRE TECHNOLOGY (mixta)	9 (Concedida S/D)	GLOBALLAB CORP.	194
521764	08/08/2022	HUGINFA	5 (Concedida S/D)	SANOPI PASTEUR INC.	165
521766	08/08/2022	RESNYRVA	5 (Concedida S/D)	SANOPI PASTEUR INC.	165
521767	08/08/2022	SYNGENTA GROUP (mixta)	1 (Concedida S/D)	SYNGENTA PARTICIPATIONS AG	194
521768	08/08/2022	BEYFORTUS	5 (Concedida S/D)	SANOPI PASTEUR INC.	165
521769	08/08/2022	CHARLIE'S AEROBIC TRAINING FACTORY (mixta)	41 (Concedida)	Carlos Alberto Pombo Faux y Diego Jeronimo Pombo Faux	194
521772	08/08/2022	BORN PRETTY (mixta)	3 (Concedida S/D)	SHENZHEN BORN PRETTY TECHNOLOGY CO.,LTD	212
521773	08/08/2022	VGR	11 (Concedida) y 8 (Concedida)	Cosmetica Profesional SRL	216
521776	08/08/2022	CHOCOTANGA	30 (Concedida S/D)	Gonzalo Ciosek	
521777	08/08/2022	CNHI INDUSTRIAL (mixta)	4 (Concedida S/D) y 1 (Concedida S/D)	CNH Industrial N.V.	245
521778	08/08/2022	APITER DERMA CREMA DE ORDEÑE ORIGINAL LA DE LA VAQUITA ORIGINAL (mixta)	3 (Concedida)	APITER S.A	212
521779	08/08/2022	ENCONCRETO (mixta)	19 (Concedida S/D)	Ezequiel Pereira	
521782	08/08/2022	PHI CENTRO PHI ODONTOLOGÍA INTEGRAL (mixta)	44 (Concedida S/D)	OLIVERA PERTUSSO, GABRIEL ENRIQUE	189
521784	18/08/2022	PINARES	33 (Concedida S/D)	Joaquin Decarlini	
521795	08/08/2022	ULTIUM DRIVE	12 (Concedida S/D)	GENERAL MOTORS LLC	136
521799	29/08/2022	HARAS DE LA POMME	44 (Concedida), 43 (Concedida), 41 (Concedida), 39 (Concedida), 35 (Concedida) y 31 (Concedida)	TUSAN S.A.	144
521806	08/08/2022	ONE I-BOOST (mixta)	5 (Concedida)	LAKINOR S.A.	34
521831	08/08/2022	OSPREY	21 (Concedida S/D)	Osprey Packs, Inc.	136

N° Exp	Resolución	Marca	Clases	Titular	Ag.
			y 18 (Concedida S/D)		
521832	08/08/2022	(figurativa)	30 (Concedida)	ARCOR S.A.I.C.	154
521833	08/08/2022	(figurativa)	21 (Concedida S/D) y 18 (Concedida S/D)	Osprey Packs, Inc.	94
521834	08/08/2022	(figurativa)	30 (Concedida)	ARCOR S.A.I.C.	154
521845	08/08/2022	STAYFRESH	3 (Concedida S/D)	Melany Estable	
521848	08/08/2022	DON PIG	29 (Concedida S/D)	MOREIRA BESSO, GERARD DANIEL	189
521849	08/08/2022	ENDOPEEL	44 (Concedida), 41 (Concedida) y 5 (Concedida)	LUKSENBURG WIERNIK, ARIEL	189
521853	08/08/2022	IUDDE	41 (Concedida S/D)	Maria Elena De Luca Gorriaran	
521855	08/08/2022	ASTEMO	12 (Concedida), 9 (Concedida) y 7 (Concedida)	Hitachi Astemo, Ltd.	201
521856	08/08/2022	EL SHOW DE LA TARDE	41 (Concedida), 38 (Concedida) y 35 (Concedida)	S.A.E.T.A.	101
521858	08/08/2022	ARMOUR	1 (Concedida S/D)	Koch Agronomic Services, LLC	194
521859	08/08/2022	(figurativa)	29 (Concedida S/D)	GELCO S.A.S.	165
521864	08/08/2022	BOM PRINCIPIO (mixta)	30 (Concedida S/D) y 29 (Concedida S/D)	FABRICA DE DOCES LEDUR LTDA	34
521867	08/08/2022	RISEN (mixta)	12 (Concedida S/D)	ZHONGCE RUBBER GROUP COMPANY LIMITED	34
521868	08/08/2022	BIS N (mixta)	12 (Concedida S/D)	ZHONGCE RUBBER GROUP COMPANY LIMITED	34
521869	08/08/2022	MÍA BISTRO	43 (Concedida)	Emanuel Kostadinov y Véronica Rucks Del Bo	232
521870	08/08/2022	EVALUNA CARTERAS Y MAS (mixta)	25 (Concedida) y 18 (Concedida)	LUCILA SASIAS MENONI	

<b>N° Exp</b>	<b>Resolución</b>	<b>Marca</b>	<b>Clases</b>	<b>Titular</b>	<b>Ag.</b>
521871	08/08/2022	EL SEÑOR DE LOS NOVILLOS (mixta)	29 (Concedida S/D)	RUBEN DARIO LARROSA	
521874	18/08/2022	AVOCADO TIENDA NATURAL (mixta)	43 (Concedida S/D), 35 (Concedida S/D), 30 (Concedida S/D) y 29 (Concedida S/D)	Leandro Baisón	
521875	08/08/2022	RRR RODRÍGUEZ BEER (mixta)	32 (Concedida S/D)	Sergio Rodríguez; Jorge Rodríguez y Fabio Rodríguez	
521886	08/08/2022	PROLUB HYDRATHAN	10 (Concedida)	SOPHIA HOLDINGS, S.A. DE C.V.	34
521888	08/08/2022	MERCADO PAGO POINT (mixta)	36 (Concedida), 35 (Concedida) y 9 (Concedida)	Marketplace Investments LLC	94
521889	08/08/2022	PROLUB HYFRESH	10 (Concedida)	SOPHIA HOLDINGS, S.A. DE C.V.	34
521892	08/08/2022	SOMAX	9 (Concedida)	Leonardo Carlos Laluz Varona	220
521898	08/08/2022	CHUWI	9 (Concedida)	PC SERVICES.A.	104
521903	08/08/2022	FERTIVIDA (mixta)	1 (Concedida S/D)	ALBA MILAGRO International S.p.A.	34
521904	08/08/2022	REAP	5 (Concedida S/D)	Sulphur Mills Limited	201
521906	10/08/2022	REAP	1 (Concedida S/D)	Sulphur Mills Limited	201
521908	08/08/2022	EUROPIE (mixta)	44 (Concedida) y 10 (Concedida S/D)	EUROPIE S.A.	144
521909	08/08/2022	AUTHOMIX (mixta)	12 (Concedida S/D)	CAR-CENTRAL DE AUTOPECAS E ROLAMENTOS LTDA	101
521915	08/08/2022	ANTICA CERVEZA ARTESANAL (mixta)	32 (Concedida S/D)	Carlos Marcelo Lopez-Lage Moreira	
521916	08/08/2022	RETAILLOGIC (mixta)	35 (Concedida S/D)	RETAIL LOGIC S.A.	94
521919	10/08/2022	CHEVRONI GARDEN & HOME	35 (Concedida)	CASAGUIA S.R.L.	201
521920	10/08/2022	BP BAROMÉTRICA PEREIRA (mixta)	44 (Concedida) y 40 (Concedida)	Robert Amilcar Pereira Rodriguez	212
521922	08/08/2022	DRAGONFLY	10 (Concedida S/D)	Alcon Inc.	194
521923	08/08/2022	GREENBOX (mixta)	9 (Concedida)	MARCELO VILLAR	233

N° Exp	Resolución	Marca	Clases	Titular	Ag.
521925	08/08/2022	LEGENDARIO (mixta)	25 (Concedida S/D)	Gaston Acuña	
521929	10/08/2022	KUNSTMANN CRAFT BAR	43 (Concedida S/D)	CERVECERÍA KUNSTMANN S.A.	219
521930	10/08/2022	BISOC	5 (Concedida)	BALIARDA S.A.	201
521931	10/08/2022	INCUBA	45 (Concedida), 37 (Concedida), 36 (Concedida) y 35 (Concedida)	COOPERATIVA DE TRABAJO INCUBA	
521932	10/08/2022	ESOGEL	5 (Concedida)	ANTIA MOLL Y CIA. S.A.	201
521933	10/08/2022	GASTRIGEL	5 (Concedida)	ANTIA MOLL Y CIA. S.A.	201
521942	10/08/2022	DE LA MERCED	25 (Concedida)	María Marta Romero Martínez	154
521966	10/08/2022	(figurativa)	5 (Concedida)	GLORIA S.A.	144
521970	10/08/2022	(figurativa)	29 (Concedida)	GLORIA S.A.	144
521972	11/08/2022	(figurativa)	30 (Concedida)	GLORIA S.A.	144
521975	11/08/2022	(figurativa)	31 (Concedida)	GLORIA S.A.	144
521976	11/08/2022	(figurativa)	32 (Concedida)	GLORIA S.A.	144
521977	11/08/2022	GLORIA (mixta)	5 (Concedida)	GLORIA S.A.	144
521978	11/08/2022	GLORIA (mixta)	29 (Concedida)	GLORIA S.A.	144
521979	12/08/2022	PENINSULA RENTALS	36 (Concedida) y 35 (Concedida)	PENINSULA MANAGEMENT URUGUAY S.R.L.	201
521980	11/08/2022	GLORIA (mixta)	30 (Concedida)	GLORIA S.A.	144
521982	11/08/2022	GLORIA (mixta)	32 (Concedida)	GLORIA S.A.	144
521983	11/08/2022	GLORIA (mixta)	5 (Concedida)	GLORIA S.A.	144
521984	12/08/2022	GLORIA (mixta)	29 (Concedida)	GLORIA S.A.	144
521985	12/08/2022	GLORIA (mixta)	30 (Concedida)	GLORIA S.A.	144
521987	12/08/2022	AKREOS	10 (Concedida S/D)	Bausch + Lomb Ireland Limited	212
521988	12/08/2022	GLORIA (mixta)	32 (Concedida)	GLORIA S.A.	144
521989	12/08/2022	VULCANO ENERGY DRINK (mixta)	32 (Concedida S/D)	I9 - COMERCIO E ATACADO DE ALIMENTOS, BEBIDAS E MATERIAS PRIMAS LTDA.	34
521991	12/08/2022	GLORIA (mixta)	5 (Concedida)	GLORIA S.A.	144

N° Exp	Resolución	Marca	Clases	Titular	Ag.
521992	12/08/2022	GLORIA (mixta)	29 (Concedida)	GLORIA S.A.	144
521994	12/08/2022	GLORIA (mixta)	30 (Concedida)	GLORIA S.A.	144
521996	12/08/2022	GLORIA (mixta)	32 (Concedida)	GLORIA S.A.	144
522000	08/08/2022	JE PACIENTES	44 (Concedida S/D) y 9 (Concedida S/D)	JOHNSON & JOHNSON	194
522002	08/08/2022	SNAPSET	10 (Concedida S/D)	Bausch + Lomb Ireland Limited	212
522004	08/08/2022	GLORIA (mixta)	5 (Concedida)	GLORIA S.A.	144
522009	08/08/2022	GLORIA (mixta)	5 (Concedida)	GLORIA S.A.	144
522010	08/08/2022	GLORIA (mixta)	29 (Concedida)	GLORIA S.A.	144
522011	08/08/2022	GLORIA (mixta)	30 (Concedida)	GLORIA S.A.	144
522013	08/08/2022	GLORIA (mixta)	32 (Concedida)	GLORIA S.A.	144
522014	08/08/2022	DOBBLE (mixta)	28 (Concedida S/D)	ASMODEE GROUP	144
522015	10/08/2022	VITA BIOSA PROBIOTA (mixta)	32 (Concedida), 29 (Concedida) y 5 (Concedida)	Biosa ApS	144
522016	08/08/2022	IBRAMED	10 (Concedida)	BIOSISTEMAS (Milman Correa Jorge Daniel)	232
522020	08/08/2022	UY HOME (mixta)	35 (Concedida)	BENTOS, CRISTOPHER	189
522022	08/08/2022	AGUILAR (mixta)	16 (Concedida) y 9 (Concedida)	EDITORIAL SUDAMERICANA URUGUAYA S.A.	181
522023	08/08/2022	SUMA DE LETRAS (mixta)	9 (Concedida S/D)	EDITORIAL SUDAMERICANA URUGUAYA S.A.	181
522024	08/08/2022	LOTO (mixta)	41 (Concedida), 31 (Concedida), 30 (Concedida) y 29 (Concedida)	TZUNG CHE TENG y TENG YANG VIVIANA SOCIEDAD DE HECHO	220
522028	09/08/2022	TODOPYMES (mixta)	36 (Concedida) y 35 (Concedida)	NUXTAREL S.A.	94
522032	12/08/2022	ECO PACKING 2000 (mixta)	35 (Concedida)	CGPLAST S.R.L.	220
522033	12/08/2022	ECO 2000 (mixta)	16 (Concedida S/D)	CGPLAST S.R.L.	220
522034	08/08/2022	BULBS&ROOTS YOU. HAIR. WE CARE. (mixta)	3 (Concedida S/D)	PROFESSIONAL BY FAMA SRL	194

N° Exp	Resolución	Marca	Clases	Titular	Ag.
522036	08/08/2022	MOBIGAL PLUS II	5 (Concedida)	Gallia Indústria Farmacêutica Eireli	165
522037	08/08/2022	LOTES DEL MUNDO (mixta)	36 (Concedida)	Beccar SAS	172
522038	08/08/2022	MOBIGAL MSM	5 (Concedida)	Gallia Indústria Farmacêutica Eireli	165
522039	08/08/2022	MOBIGAL BCAA	5 (Concedida)	Gallia Indústria Farmacêutica Eireli	165
522041	08/08/2022	LUXLISS (mixta)	3 (Concedida S/D)	Li Meihong	144
522044	08/08/2022	BEAVER (mixta)	3 (Concedida S/D)	Zhang Hongkui	144
522046	08/08/2022	LA TORDILLA (mixta)	25 (Concedida) y 18 (Concedida)	Aneken Viña	
522051	08/08/2022	DECAKILA (mixta)	14 (Concedida S/D)	CHONGQING AMITY MACHINERY CO., LTD.	144
522052	08/08/2022	DERMACEUTIC	3 (Concedida S/D)	Laura Helena Ricca Gfeller	
522054	08/08/2022	PUNTO CERO (mixta)	35 (Concedida)	MARCOS RAUL LARRAURI CABALLERO	163
522055	10/08/2022	DESDE 2021 HORNO DAME FUEGO (mixta)	43 (Concedida)	PERROTA MADÍAS, EMILIANO NICOLÁS	189
522056	12/08/2022	ALMA BOX	39 (Concedida) y 35 (Concedida)	DA PRA BARREIRO, MARÍA INÉS	189
522057	10/08/2022	SOUL MOVEMOS TUS IDEAS (mixta)	42 (Concedida), 38 (Concedida) y 35 (Concedida)	PERVENIO S.A.	
522060	09/08/2022	EAT PUNTA	41 (Concedida S/D) y 35 (Concedida S/D)	Antony Danno	
522065	08/08/2022	AURORA	16 (Concedida) y 9 (Concedida)	AURORA CORPORATION	201
522069	08/08/2022	AMPARITO (mixta)	30 (Concedida)	ALIMENTOS MAMINA S.R.L.	144
522074	08/08/2022	TECFIL (mixta)	7 (Concedida S/D)	SOFAPE FABRICANTE DE FILTROS S.A.	34
522075	08/08/2022	FILTROS VOX (mixta)	7 (Concedida S/D)	SOFAPE FABRICANTE DE FILTROS S.A.	34
522076	10/08/2022	TECFIL MAX PRO PESADO (mixta)	7 (Concedida S/D)	SOFAPE FABRICANTE DE FILTROS S.A.	34
522077	10/08/2022	TECFIL RACING TEAM (mixta)	7 (Concedida S/D)	SOFAPE FABRICANTE DE FILTROS S.A.	34
522078	10/08/2022	TECFIL MAX VISION (mixta)	12 (Concedida S/D)	SOFAPE FABRICANTE DE FILTROS S.A.	34
522082	10/08/2022	BLOOMBERG LÍNEA	41 (Concedida), 39	Bloomberg Finance L.P.	201

N° Exp	Resolución	Marca	Clases	Titular	Ag.
			(Concedida), 38 (Concedida), 36 (Concedida) y 35 (Concedida)		
522083	09/08/2022	NERVIVE	10 (Concedida S/D), 5 (Concedida S/D) y 3 (Concedida S/D)	The Procter & Gamble Company	212
522086	09/08/2022	OLA MAE	35 (Concedida) y 25 (Concedida)	Valentina maria llama lopez; María Emilia llama López; Agustina vidal y SOFIA MARTINEZ INTROINI	212
522087	10/08/2022	FINDER (mixta)	45 (Concedida) y 42 (Concedida)	Securitas Sistemas SA	216
522088	10/08/2022	THE FARRA (mixta)	25 (Concedida)	SILVIA FACCIOLO	194
522089	10/08/2022	LAB SANITARIA & GAS (mixta)	37 (Concedida S/D)	Luis Batista	
522090	09/08/2022	REGENERA AMÉRICA (mixta)	35 (Concedida)	Marketplace Investments LLC	94
522093	11/08/2022	GIVT DAR & REGALAR (mixta)	36 (Concedida S/D) y 35 (Concedida S/D)	Marcos Maria Acle Mautone	
522094	11/08/2022	LO UV (mixta)	3 (Concedida S/D)	CLEANDER INTANGIBLES LLC	189
522095	11/08/2022	KITE MOBILITY (mixta)	12 (Concedida S/D)	MAURICIO PARAMOS	
522097	16/08/2022	LA FERIA DEL PASTEL FRITO	30 (Concedida S/D)	María Jacqueline Montelongo Carbajal	
522098	11/08/2022	WE PLAY VOLVAMOS A JUGAR (mixta)	28 (Concedida S/D)	Gabriel Kaniewicz	
522100	08/08/2022	508 (mixta)	43 (Concedida)	DIEGO LUCAS VILLARREAL y GABRIELA NAIR FRIPP	219
522110	08/08/2022	LAMICAVIR	5 (Concedida)	LABORATORIO LIBRA S.A.	129
522111	08/08/2022	LAS DOS ORILLAS (mixta)	30 (Concedida S/D)	MAXIMILIANO RAMOS CARBAJAL	219
522112	08/08/2022	ELISA (mixta)	44 (Concedida S/D)	Elizabeth Evelyn Villani Barrios	34
522122	08/08/2022	CORRIERI	30 (Concedida)	Trondial S.A.	172
522125	18/08/2022	CHURROS LA VALENCIANA GOURMET (mixta)	43 (Concedida S/D) y 30 (Concedida)	Carolina Melo Bottini	

N° Exp	Resolución	Marca	Clases	Titular	Ag.
			S/D)		
522129	08/08/2022	PARFUMERIE TIKI DEPUIS 1942 (mixta)	3 (Concedida)	PARFUMERIE TIKI	212
522132	08/08/2022	PP PROPERTY PARTNERS R (mixta)	36 (Concedida S/D)	Property Partners Corp S.A.	144
522133	08/08/2022	ELEKTRA (mixta)	41 (Concedida S/D) y 9 (Concedida S/D)	Elektra Entertainment Group	144
522134	08/08/2022	RINCÓN VERDE (mixta)	35 (Concedida)	COBOE S.A.	212
522135	08/08/2022	COSMÉTICA SUSTENTABLE (mixta)	35 (Concedida)	COBOE S.A	212
522136	08/08/2022	3M DIAMOND GRADE	17 (Concedida S/D)	3M COMPANY	212
522137	08/08/2022	BONLÉ (mixta)	5 (Concedida)	GLORIA S.A.	144
522138	08/08/2022	BONLÉ (mixta)	29 (Concedida)	GLORIA S.A.	144
522139	08/08/2022	BONLÉ (mixta)	30 (Concedida)	GLORIA S.A.	144
522141	08/08/2022	BONLÉ (mixta)	32 (Concedida)	GLORIA S.A.	144
522142	08/08/2022	GLORIA (mixta)	5 (Concedida)	GLORIA S.A.	144
522143	08/08/2022	GLORIA (mixta)	29 (Concedida)	GLORIA S.A.	144
522144	08/08/2022	GLORIA (mixta)	30 (Concedida)	GLORIA S.A.	144
522146	08/08/2022	GLORIA (mixta)	32 (Concedida)	GLORIA S.A.	144
522147	08/08/2022	PIL ANDINA (mixta)	5 (Concedida)	GLORIA S.A.	144
522148	08/08/2022	PIL ANDINA (mixta)	29 (Concedida)	GLORIA S.A.	144
522149	08/08/2022	PIL ANDINA (mixta)	30 (Concedida)	GLORIA S.A.	144
522152	08/08/2022	GLORIA LIGHT (mixta)	5 (Concedida)	GLORIA S.A.	144
522153	08/08/2022	GLORIA LIGHT (mixta)	29 (Concedida)	GLORIA S.A.	144
522154	08/08/2022	GLORIA LIGHT (mixta)	30 (Concedida)	GLORIA S.A.	144
522156	08/08/2022	GLORIA LIGHT (mixta)	32 (Concedida)	GLORIA S.A.	144
522157	08/08/2022	SOALÉ (mixta)	5 (Concedida)	GLORIA S.A.	144
522158	08/08/2022	SOALÉ (mixta)	29 (Concedida)	GLORIA S.A.	144
522159	08/08/2022	SOALÉ (mixta)	30 (Concedida)	GLORIA S.A.	144
522161	08/08/2022	SOALÉ (mixta)	32 (Concedida)	GLORIA S.A.	144
522162	29/08/2022	GLORIA LECHE EVAPORADA SEMIDESCREMADA (mixta)	5 (Concedida S/D)	GLORIA S.A.	144



N° Exp	Resolución	Marca	Clases	Titular	Ag.
522163	29/08/2022	GLORIA LECHE EVAPORADA SEMIDESCREMADA (mixta)	29 (Concedida S/D)	GLORIA S.A.	144
522164	10/08/2022	GLORIA LECHE EVAPORADA SEMIDESCREMADA (mixta)	30 (Concedida)	GLORIA S.A.	144
522166	11/08/2022	GLORIA LECHE EVAPORADA SEMIDESCREMADA (mixta)	32 (Concedida)	GLORIA S.A.	144
522167	19/08/2022	RITUAL	41 (Concedida)	Emil Montgomery Soler	222
522168	08/08/2022	BULERÍA (mixta)	43 (Concedida)	GISEL LORELEY HERMIN CARTAGENA	220
522171	08/08/2022	FOXSYS	45 (Concedida), 42 (Concedida) y 9 (Concedida)	FOXYHOUSE SRL	
522182	08/08/2022	SOLOOP	9 (Concedida S/D)	GUANGDONG OPPO MOBILE TELECOMMUNICATIONS CORP., LTD.	34
522196	08/08/2022	MALAKITA (mixta)	18 (Concedida)	CASAS MIGLIARO, MARÍA IRENE	201
522199	08/08/2022	NOSTRINE	5 (Concedida)	ANTIA MOLL Y CIA. S.A.	201
522209	08/08/2022	BEN'S ORIGINAL (mixta)	30 (Concedida) y 29 (Concedida)	Mars, Incorporated	245
522210	08/08/2022	AUSTRAL (mixta)	25 (Concedida) y 18 (Concedida)	MACRI, MARIO C.	245
522211	08/08/2022	ALBORINI (mixta)	35 (Concedida)	ALBORINI S.A.S.	212
522212	08/08/2022	SNIMAY	20 (Concedida)	Guangzhou Snimay Furniture Co., Ltd	212
522213	08/08/2022	AL ABRIR UN LIBRO	41 (Concedida)	Leticia Riolfo y Leonardo Díaz	
522214	08/08/2022	FISIOGENESIS (mixta)	44 (Concedida)	LUIS FERNANDEZ	
522215	08/08/2022	PYMEPOSITIVA	35 (Concedida)	Juan Torres	
522222	08/08/2022	AVA EXPERIENCIA GOURMET (mixta)	43 (Concedida S/D)	Richard Gabriel SUAREZ ACOSTA	
522223	08/08/2022	TRAVELLING PETS (mixta)	44 (Concedida S/D), 43 (Concedida S/D), 39 (Concedida S/D) y 35 (Concedida)	RDOCARGO SRL	
522225	08/08/2022	URUCAMPER	39 (Concedida S/D)	Enrique Duarte Cosentino	

N° Exp	Resolución	Marca	Clases	Titular	Ag.
522226	08/08/2022	CRUSH	32 (Concedida)	European Refreshments	94
522229	08/08/2022	GREENBOND METER (mixta)	36 (Concedida)	Heimdall Technologies OÜ	179
522230	08/08/2022	MIRROREYE	9 (Concedida S/D)	Stoneridge, Inc.	34
522233	08/08/2022	SINSIN (mixta)	30 (Concedida)	Pankara S.R.L.	
522236	08/08/2022	DARTEK (mixta)	7 (Concedida S/D)	Jiangsu DAYI Power Tools Co., Ltd	144
522237	08/08/2022	PICKIT (mixta)	39 (Concedida S/D), 35 (Concedida S/D) y 9 (Concedida S/D)	Pickit LLC	201
522238	08/08/2022	DARTEK (mixta)	9 (Concedida S/D)	Jiangsu DAYI Power Tools Co., Ltd	144
522239	08/08/2022	PICKIT	39 (Concedida S/D), 35 (Concedida S/D) y 9 (Concedida S/D)	Pickit LLC	201
522241	08/08/2022	ARTMOST (mixta)	7 (Concedida S/D)	Jiangsu DAYI Power Tools Co., Ltd	144
522242	08/08/2022	BIOHEALTH GROUP BHG (mixta)	44 (Concedida) y 10 (Concedida)	VILLA SAENZ, CATALINA	201
522243	08/08/2022	BSOUL BY BODY & SOUL	28 (Concedida S/D), 25 (Concedida S/D) y 9 (Concedida S/D)	FORUS S.A.	245
522245	11/08/2022	ARTMOST (mixta)	9 (Concedida S/D)	Jiangsu DAYI Power Tools Co., Ltd	144
522247	08/08/2022	VINDA (mixta)	16 (Concedida S/D)	VINDA PAPER (CHINA) COMPANY LTD.	144
522248	08/08/2022	VESPA 75 1946 - 2021 (mixta)	25 (Concedida S/D), 21 (Concedida S/D), 16 (Concedida S/D), 14 (Concedida S/D) y 12 (Concedida S/D)	PIAGGIO & C. S.P.A.	144
522249	10/08/2022	P (mixta)	35 (Concedida S/D)	PLICOSA GROUP	144
522250	08/08/2022	BC BARICAPS (mixta)	5 (Concedida S/D)	ANDREA CRISTINA DOS SANTOS	163
522253	08/08/2022	MILITEC 1 (mixta)	4 (Concedida S/D) y 1 (Concedida S/D)	Militec Brasil Importação e Comércio Ltda.	194
522256	08/08/2022	BREUS	35 (Concedida) y 25	Felipe Lalinde; German Lalinde y Hector Artigas	

N° Exp	Resolución	Marca	Clases	Titular	Ag.
			(Concedida)	Lalinde	
522258	08/08/2022	VIA SPIGA	25 (Concedida)	Caleres, Inc.	194
522260	08/08/2022	RETIEL (mixta)	25 (Concedida)	L&H S.A.	212
522262	08/08/2022	FAMILY TOYS	35 (Concedida)	MABENIR S.A.	189
522271	08/08/2022	SENSCIENCE	3 (Concedida S/D)	Henkel AG & Co. KGaA	192
522272	08/08/2022	MARCOBUS (mixta)	35 (Concedida)	Eduardo Da Costa	
522281	08/08/2022	HOGARON (mixta)	35 (Concedida), 11 (Concedida), 9 (Concedida) y 7 (Concedida)	AMV STORE SRL	94
522282	08/08/2022	PUBLIMOTO (mixta)	35 (Concedida)	DIAZ CALERO FABIO PAULO	220
522283	08/08/2022	CRUSHER DISTANCE (mixta)	25 (Concedida S/D)	GIORGIO ARMANI S.P.A.	34
522286	08/08/2022	SALESDRIVER	42 (Concedida S/D) y 9 (Concedida S/D)	LEADER UP SISTEMAS LIMITADA	34
522287	08/08/2022	APOLO (mixta)	13 (Concedida)	Sr. Fabio Raúl MORICONI	201
522288	08/08/2022	SALESFARMA (mixta)	42 (Concedida S/D) y 9 (Concedida S/D)	LEADER UP SISTEMAS LIMITADA	34
522289	08/08/2022	LENGUA UNA REVISTA PARA LEER (mixta)	9 (Concedida S/D)	EDITORIAL SUDAMERICANA URUGUAYA S.A.	181
522291	08/08/2022	PURSUE FLAVOR	34 (Concedida S/D)	Philip Morris Brands Sàrl	201
522292	08/08/2022	FRAMORE	30 (Concedida) y 29 (Concedida)	MARCELO ANGEL BORTOLOT	129
522293	08/08/2022	CORTESANOS	30 (Concedida) y 29 (Concedida)	PEPSICO, INC.	201
522296	08/08/2022	CAPRICHIO BUMMIS	5 (Concedida S/D)	CONFECÇÕES CAPRICHIO LTDA	144
522297	08/08/2022	CASA DE GARZON	35 (Concedida)	AGROLAND S.A.	216
522299	08/08/2022	CABERG	9 (Concedida)	SYLVIA KATZ	
522310	08/08/2022	CROMABITS (mixta)	42 (Concedida S/D)	Alejandro Moreira	
522313	10/08/2022	ECOFLOW (mixta)	9 (Concedida S/D)	EcoFlow Inc.	201
522314	08/08/2022	FLOAFERS	25 (Concedida)	Floafers LLC	194

<b>N° Exp</b>	<b>Resolución</b>	<b>Marca</b>	<b>Clases</b>	<b>Titular</b>	<b>Ag.</b>
522316	08/08/2022	EF ECOFLOW (mixta)	9 (Concedida S/D)	EcoFlow Inc.	201
522317	08/08/2022	TASTEE FREEZ (mixta)	43 (Concedida S/D)	TASTEE FREEZ, LLC	205
522319	08/08/2022	TASTEE FREEZ (mixta)	43 (Concedida S/D)	TASTEE FREEZ, LLC	205
522320	08/08/2022	TASTEE FREEZ	43 (Concedida S/D)	TASTEE FREEZ, LLC	205
522322	08/08/2022	SYSMED	19 (Concedida)	RAFAEL MALVAREZ ROSENDO	194
522323	18/08/2022	W WIENERSCHNITZEL (mixta)	43 (Concedida S/D)	GALARDI GROUP, INC.	205
522324	08/08/2022	COCINASOCULTAS	43 (Concedida) y 35 (Concedida)	MARCELO RODRIGUEZ.	144
522327	18/08/2022	WIENERSCHNITZEL	43 (Concedida S/D)	GALARDI GROUP, INC.	205
522329	08/08/2022	ACER (mixta)	35 (Concedida), 28 (Concedida), 20 (Concedida), 14 (Concedida) y 9 (Concedida)	Acer Incorporated	181
522331	08/08/2022	WORLD'S MOST WANTED WIENER	43 (Concedida S/D)	GALARDI GROUP, INC.	205
522336	08/08/2022	PEUGEOT PARTNER	12 (Concedida S/D)	Automobiles PEUGEOT	144
522338	08/08/2022	UROVAL	5 (Concedida)	LABORATORIO GADOR S.A.	165
522339	08/08/2022	URO-VAL	5 (Concedida)	LABORATORIO GADOR S.A.	165
522340	18/08/2022	ALLEZ (mixta)	35 (Concedida), 25 (Concedida) y 18 (Concedida)	FERNANDO DANIEL MUNIZ MORRISON	234
522341	08/08/2022	KAIYI (mixta)	37 (Concedida) y 12 (Concedida)	Yibin Kaiyi Automobile Co., Ltd.	205
522342	08/08/2022	(figurativa)	37 (Concedida) y 12 (Concedida)	Yibin Kaiyi Automobile Co., Ltd.	205
522344	08/08/2022	JIMMY CHOO ILLICIT (mixta)	3 (Concedida S/D)	J. CHOO LIMITED	194
522346	08/08/2022	BLEM (mixta)	3 (Concedida S/D)	S. C. JOHNSON & SON, INC.	194
522347	11/08/2022	MINERAL BEACH DEFENSE ACTIVE PERFORMANCE	3 (Concedida S/D)	JOHNSON & JOHNSON	194
522360	08/08/2022	PIZZINI	16 (Concedida)	PIZZINI S.A.	219
522368	10/08/2022	HEDONÉ, COSMÉTICA NATURAL	44 (Concedida S/D),	EUGENIA ARBELO	

N° Exp	Resolución	Marca	Clases	Titular	Ag.
		BY EUGENIA ARBELO (mixta)	35 (Concedida S/D) y 3 (Concedida S/D)		
522371	08/08/2022	RUM RUM (mixta)	35 (Concedida), 25 (Concedida), 18 (Concedida) y 3 (Concedida)	YOLANDA BEATRIZ YAPUR	94
522377	08/08/2022	OLMOS	2 (Concedida)	Zalwin S.A.	201
522378	08/08/2022	CISER COLOR (mixta)	2 (Concedida S/D)	CIA. INDUSTRIAL H. CARLOS SCHNEIDER	194
522379	08/08/2022	MESABRAVA	43 (Concedida)	MESABRAVA S.R.L	184
522380	10/08/2022	CITREA (mixta)	9 (Concedida S/D)	Citizen Tokei Kabushiki Kaisha (también comerciando como Citizen Watch Co., Ltd.	34
522381	11/08/2022	PLUREN	36 (Concedida S/D), 25 (Concedida S/D), 24 (Concedida S/D) y 21 (Concedida S/D)	LOJAS RENNER S.A.	34
522382	08/08/2022	CUTIMED	5 (Concedida S/D)	BSN medical GmbH	240
522383	15/08/2022	PR PRONUTRITION AGRO TECHNOLOGIES (mixta)	42 (Concedida)	EINIGE SRL	220
522384	10/08/2022	BIENESTAR	2 (Concedida)	Akzo Nobel Coatings International B.V.	212
522385	08/08/2022	TECNOLOG	42 (Concedida) y 35 (Concedida)	RUBEN AZAR SCARONE	118
522386	08/08/2022	CENTRO TECNOLOG	42 (Concedida) y 35 (Concedida)	RUBEN AZAR SCARONE	118
522387	10/08/2022	D´CLASSE	16 (Concedida)	BOYERCO S.A.	
522399	08/08/2022	HUEVOS WEEK! (mixta)	29 (Concedida S/D)	VARTQUEZ KAVEDJIAN	219
522401	08/08/2022	NEVE	9 (Concedida S/D)	Vimar S.p.A.	192
522404	23/08/2022	(figurativa)	45 (Concedida S/D), 42 (Concedida S/D), 40 (Concedida S/D), 39 (Concedida S/D),	Iron Mountain Incorporated	192

N° Exp	Resolución	Marca	Clases	Titular	Ag.
			38 (Concedida S/D), 37 (Concedida S/D), 35 (Concedida S/D), 21 (Concedida S/D), 20 (Concedida S/D), 16 (Concedida S/D) y 9 (Concedida S/D)		
522409	23/08/2022	IBI CRAFT (mixta)	16 (Concedida)	MAPA S.A.	192
522412	23/08/2022	BORSEHUNG GERMANY (mixta)	17 (Concedida S/D), 12 (Concedida S/D), 9 (Concedida S/D) y 7 (Concedida S/D)	BORSEHUNG GMBH	34
522417	29/08/2022	INFINISCENT	3 (Concedida S/D)	BEIERSDORF AG	136
522418	23/08/2022	INFINIFRESH	3 (Concedida S/D)	BEIERSDORF AG	136
522440	29/08/2022	PUNTA DEL ESTE (mixta)	43 (Concedida), 41 (Concedida), 39 (Concedida), 35 (Concedida) y 25 (Concedida)	PUNTA DEL ESTE CONVENTION & VISITORS BUREAU	201
522442	29/08/2022	EL LUGAR QUE ELEGIMOS	39 (Concedida) y 35 (Concedida)	PUNTA DEL ESTE CONVENTION & VISITORS BUREAU	201
522443	23/08/2022	VERTEX	5 (Concedida S/D)	Vertex Pharmaceuticals Incorporated	216
522445	23/08/2022	VERTEX (mixta)	5 (Concedida S/D)	Vertex Pharmaceuticals Incorporated	216
522448	29/08/2022	VOYAGE BLEND	30 (Concedida S/D)	Starbucks Corporation	212
522450	30/08/2022	HEPALIVE FORTE NATURE'S GARDEN (mixta)	5 (Concedida)	CARVAGU S.A.	201
522453	30/08/2022	OVARINA NATURE'S GARDEN (mixta)	5 (Concedida)	CARVAGU S.A.	201
522454	29/08/2022	NATURE'S GARDEN (mixta)	30 (Concedida)	CARVAGU S.A.	201
522455	29/08/2022	GOOCO JEANS (mixta)	25 (Concedida S/D)	MARLY SOLANGER AGUIRRE ZABALA VAZQUEZ	

N° Exp	Resolución	Marca	Clases	Titular	Ag.
522456	29/08/2022	SUPERMALL.UY (mixta)	39 (Concedida) y 35 (Concedida)	URUFORUS S.A.	181
522460	29/08/2022	TUPRODUCTOUY (mixta)	35 (Concedida)	MELLO ODDONE GONZALO UNIPERSONAL	
522461	23/08/2022	GUAPETÓN (mixta)	12 (Concedida S/D) y 9 (Concedida S/D)	MELLO ODDONE GONZALO UNIPERSONAL	
522462	23/08/2022	TELEQT	5 (Concedida S/D)	PFIZER INC.	194
522463	29/08/2022	GRUPOS ELIJO ESTAR BIEN	44 (Concedida)	ELBAUM, ALBERTO	227
522464	29/08/2022	SANCHITO LA TAQUERÍA	43 (Concedida) y 39 (Concedida)	Alvaro Javier Russi Ranguis	
522465	29/08/2022	LA QUINTA MONTAÑA	41 (Concedida S/D)	Alejandro Traversoni	
522466	29/08/2022	MATZA	43 (Concedida) y 39 (Concedida)	Alvaro Javier Russi Ranguis	
522471	29/08/2022	LUFECTOMAX	5 (Concedida S/D)	VIRBAC LATAM SpA	201
522475	29/08/2022	BIÓTICA CLAUSII	5 (Concedida)	LABORATORIOS HAYMANN S.A.	144
522476	30/08/2022	SUPREMO CONSEJO DEL RITO ESCOCÉS ANTIGUO Y ACEPTADO 24 DE JUNIO DE 1855 33 SAPIENTIA DEUS MEUMQUE JU (mixta)	41 (Concedida)	MASONERIA DEL URUGUAY	144
522477	29/08/2022	SUPREMO CONSEJO 33 DEUS MEUMQUE JUS (mixta)	41 (Concedida)	MASONERIA DEL URUGUAY	144
522483	29/08/2022	PERSONAS Y TECNOLOGÍA EN PERFECTA ARMONÍA	35 (Concedida)	Marketplace Investments LLC	94
522490	29/08/2022	EXP (mixta)	36 (Concedida S/D)	eXp Realty, LLC	228
522495	29/08/2022	JELA GAMES (mixta)	28 (Concedida S/D)	LAREO BATTO, MARCELO	201
522502	08/08/2022	JORANI (mixta)	35 (Concedida S/D)	JORANI DO BRASIL PLÁSTICOS EIRELI	189
522503	08/08/2022	ULTRA CIC (mixta)	1 (Concedida S/D)	AGRONATTURALIA, S.P.R. DE R.L. DE C.V.	181
522507	08/08/2022	FORTALEZA (mixta)	45 (Concedida)	FORTALEZA SEGURIDAD S.A.S.	212
522510	08/08/2022	TOPAZ TRACE (mixta)	42 (Concedida) y 9 (Concedida)	NILCO S.A.	167
522511	08/08/2022	DONNA BELLA (mixta)	25 (Concedida) y 14	TORRES DE SOUZA BETTINA ELENA	220

N° Exp	Resolución	Marca	Clases	Titular	Ag.
			(Concedida)		
522512	08/08/2022	TOPAZ SERVCORE (mixta)	42 (Concedida) y 9 (Concedida)	NILCO S.A.	167
522513	08/08/2022	TOPAZ OFD ANTI-FRAUD INTELLIGENCE (mixta)	42 (Concedida) y 9 (Concedida)	NILCO S.A.	167
522514	08/08/2022	TOPAZ MICROFINANCE (mixta)	42 (Concedida) y 9 (Concedida)	NILCO S.A.	167
522517	10/08/2022	TOPAZ BANKING (mixta)	42 (Concedida) y 9 (Concedida)	NILCO S.A.	167
522519	08/08/2022	TOPAZ CO-CREATING WITH STEFANINI (mixta)	42 (Concedida) y 9 (Concedida)	NILCO S.A.	167
522523	08/08/2022	HYFLEX	41 (Concedida)	ASOCIACION URUGUAYA ORT	201
522525	10/08/2022	TOP SYSTEMS POWERED BY STEFANINI (mixta)	42 (Concedida) y 9 (Concedida)	TOP SYSTEMS S.A.	167
522536	11/08/2022	PATA NEGRA	29 (Concedida S/D)	CATTIVELLI HNOS. S.A.	129
522537	10/08/2022	CAPA BLANCA	29 (Concedida S/D)	CATTIVELLI HNOS. S.A.	129
522541	29/08/2022	PEUGEOT (mixta)	39 (Concedida S/D), 37 (Concedida S/D), 36 (Concedida S/D), 35 (Concedida S/D) y 12 (Concedida S/D)	Automobiles PEUGEOT	144
522549	10/08/2022	(figurativa)	35 (Concedida) y 14 (Concedida)	De Beers UK Limited	94
522550	10/08/2022	FOREVERMARK	35 (Concedida) y 14 (Concedida)	De Beers UK Limited	94
522553	10/08/2022	MI CARRO CCU	35 (Concedida S/D)	COMPAÑÍA CERVECERÍAS UNIDAS S.A.	221
522555	10/08/2022	FUNDACIÓN TRAMPOLÍN OBRAS SOCIALES SALESIANAS (mixta)	41 (Concedida) y 35 (Concedida)	SOCIEDAD SAN FRANCISCO DE SALES	19
522556	10/08/2022	CLÍNICA ESTÉTICA DENTAL (mixta)	44 (Concedida S/D)	CLEDUY SRL	
522557	10/08/2022	RP ROBSON PELUQUERO (mixta)	3 (Concedida S/D)	RP COMERCIO DE COSMETICOS EIRELI	156



<b>N° Exp</b>	<b>Resolución</b>	<b>Marca</b>	<b>Clases</b>	<b>Titular</b>	<b>Ag.</b>
522562	10/08/2022	ENERSIDE (mixta)	42 (Concedida S/D), 40 (Concedida S/D), 39 (Concedida S/D), 37 (Concedida S/D), 35 (Concedida S/D), 7 (Concedida S/D) y 4 (Concedida S/D)	ENERSIDE ENERGY, S.L.	144
522563	10/08/2022	VERDE PLUS (mixta)	35 (Concedida)	OLASIO S.R.L	179
522564	10/08/2022	AUTOADAP (mixta)	41 (Concedida S/D) y 37 (Concedida S/D)	BELLENDIA PAGUAPÉ, CARLOS ALVARO	34
522566	10/08/2022	VERDE REVISTAVERDE.UY (mixta)	41 (Concedida)	OLASIO S.R.L	179
522568	08/08/2022	HYFLEX	9 (Concedida S/D)	ASOCIACION URUGUAYA ORT	201
522570	10/08/2022	ON WORLD NAZARET GLOBAL EDUCATION (mixta)	41 (Concedida S/D)	MISIONERAS HIJAS DE LA SAGRADA FAMILIA DE NAZARET	201
522571	10/08/2022	MY ECO TU VIDA SUSTENTABLE (mixta)	35 (Concedida) y 21 (Concedida)	MARTINEZ CASAS, SANDRA KARINA	201
522572	10/08/2022	LUPRANE	5 (Concedida)	ZODIAC INTERNATIONAL CORPORATION	245
522575	10/08/2022	MÉTODOT FÚTBOL CONSCIENTE (mixta)	41 (Concedida)	GRAF ESOLK, ERIKA	201
522578	10/08/2022	OROSAN	5 (Concedida S/D)	AUGUSTO COELHO IMPORTADORES S.A.	194
522579	10/08/2022	B Y E (BARRAS Y EQUIPAMIENTOS)	28 (Concedida S/D)	BRUNO SANDONATO	
522581	11/08/2022	BAMATIR	5 (Concedida)	ZODIAC INTERNATIONAL CORPORATION	245
522583	10/08/2022	UKEMP (mixta)	3 (Concedida)	INNOVACARE S.R.L	212
522584	10/08/2022	MM (mixta)	25 (Concedida)	GARMONT INTERNATIONAL S.R.L.	212
522585	10/08/2022	TP-SURE	10 (Concedida S/D)	NIPRO CORPORATION	94
522586	10/08/2022	U\$S PRE MARTILLO TERNEROS (mixta)	35 (Concedida)	PANTALLAS URUGUAY S.A.	179
522587	10/08/2022	SALMITAS	30 (Concedida)	GRUPO BIMBO S.A.B. DE C.V.	181
522589	10/08/2022	SALMAS (mixta)	30 (Concedida)	GRUPO BIMBO S.A.B. DE C.V.	181
522591	10/08/2022	SANISSIMO (mixta)	30 (Concedida)	GRUPO BIMBO S.A.B. DE C.V.	181

N° Exp	Resolución	Marca	Clases	Titular	Ag.
522592	10/08/2022	SANISSIMO (mixta)	30 (Concedida)	GRUPO BIMBO S.A.B. DE C.V.	181
522594	16/08/2022	ESCONDIDO MVD 2020 ESCONDIDO (mixta)	43 (Concedida)	DIEGO SEBASTIAN SUAREZ LIBONATTI	118
522595	10/08/2022	EMUBABY (mixta)	5 (Concedida S/D) y 3 (Concedida S/D)	Emuchile S.A	234
522598	10/08/2022	INZOL (mixta)	42 (Concedida), 35 (Concedida) y 9 (Concedida)	Inzol SRL	220
522604	10/08/2022	BIDCOM (mixta)	9 (Concedida S/D)	BIDCOM S.R.L.	144
522605	10/08/2022	MCCAIN CRISPERS	29 (Concedida S/D)	MCCAIN FOODS LIMITED	94
522608	10/08/2022	ILLUMENA	10 (Concedida S/D)	LIEBEL-FLARSHEIM COMPANY LLC	144
522609	10/08/2022	OPTISTAR	10 (Concedida S/D)	LIEBEL-FLARSHEIM COMPANY LLC	144
522610	10/08/2022	OPTIONE	10 (Concedida S/D)	LIEBEL-FLARSHEIM COMPANY LLC	144
522613	10/08/2022	JVC (mixta)	28 (Concedida S/D)	JVCKENWOOD Corporation	194
522617	10/08/2022	KENWOOD (mixta)	28 (Concedida S/D)	JVCKENWOOD Corporation	194
522621	11/08/2022	HAWKS TALON GC (mixta)	41 (Concedida)	NBA PROPERTIES, INC.	205
522622	10/08/2022	BABY LEE	3 (Concedida)	Laboratorio Ballerina Ltda.	245
522629	11/08/2022	ADN BIKER (mixta)	25 (Concedida) y 9 (Concedida)	GAME LTDA.	
522631	10/08/2022	HARDEN (mixta)	9 (Concedida)	SHANGHAI HARDEN TOOLS CO. LTD.	28
522632	10/08/2022	HARDEN PLUS (mixta)	9 (Concedida), 8 (Concedida) y 7 (Concedida)	SHANGHAI HARDEN TOOLS CO. LTD.	28
522636	10/08/2022	ENOXALOW (mixta)	5 (Concedida)	BLAU FARMACEUTICA S.A.	181
522637	10/08/2022	URICAFEL	5 (Concedida S/D)	OPKO HEALTH SPAIN, S.L.U.	212
522639	11/08/2022	BLACK PINE (mixta)	16 (Concedida)	JUMUPEL PAPÉIS E EMBALAGENS LTDA	144
522641	10/08/2022	THINKEDGE	42 (Concedida S/D) y 9 (Concedida S/D)	Lenovo (Singapore) Pte. Ltd.	194
522644	10/08/2022	COVIBLOCK	5 (Concedida S/D)	DAEWOONG PHARMACEUTICAL CO., LTD	144
522645	10/08/2022	COPA AIRLINES COURIER SU MUNDO EN MOVIMIENTO (mixta)	39 (Concedida)	Compañía Panameña de Aviación S.A.	172

N° Exp	Resolución	Marca	Clases	Titular	Ag.
522646	10/08/2022	PANCREVET	5 (Concedida S/D)	OPKO HEALTH SPAIN, S.L.U.	212
522647	10/08/2022	NG (mixta)	35 (Concedida)	COMINT-UR S.A.	245
522649	10/08/2022	SMARTFOOD	30 (Concedida) y 29 (Concedida)	PEPSICO, INC.	201
522651	10/08/2022	YALLA PARCHÍS (mixta)	45 (Concedida S/D), 42 (Concedida S/D), 41 (Concedida S/D), 38 (Concedida S/D), 35 (Concedida S/D) y 9 (Concedida S/D)	Yalla Technology FZ-LLC	34
522654	11/08/2022	COPA AIRLINES VACATIONS (mixta)	39 (Concedida)	Compañía Panameña de Aviación S.A.	172
522656	10/08/2022	THE BURGER GANG (mixta)	43 (Concedida S/D) y 16 (Concedida S/D)	DELIVERY HERO LATAM MARKETPLACE HOLDING S.A.	34
522658	11/08/2022	NEFROFORTE	5 (Concedida S/D)	OPKO HEALTH SPAIN, S.L.U.	212
522660	16/08/2022	S SAWGRASS OUTLET EL EQUILIBRIO PERFECTO ENTRE CALIDAD Y PRECIO (mixta)	35 (Concedida) y 25 (Concedida)	GASWIL S.A.	21
522662	10/08/2022	UROFLUT	5 (Concedida S/D)	OPKO HEALTH SPAIN, S.L.U.	212
522666	10/08/2022	URPRO	5 (Concedida S/D)	OPKO HEALTH SPAIN, S.L.U.	212
522667	10/08/2022	IPECRON	5 (Concedida S/D)	OPKO HEALTH SPAIN, S.L.U.	212
522668	10/08/2022	BEERCOIN	35 (Concedida)	BIZARRA S.A.	201
522669	10/08/2022	THRASHER (mixta)	25 (Concedida)	High Speed Productions, Inc.	212
522671	10/08/2022	THE DLZ (mixta)	21 (Concedida S/D)	DANIEL DALZUCHIO	163
522672	10/08/2022	ARETINA JOYAS (mixta)	14 (Concedida S/D)	LEONEL STEPANIUK	192
522674	10/08/2022	PHELINUN	5 (Concedida)	ADIENNE Pharma & Biotech SA	201
522677	10/08/2022	INDES MALLA (mixta)	10 (Concedida) y 5 (Concedida)	Fabián Grosso Antunez	104
522682	10/08/2022	PUNTOS BBVA	36 (Concedida), 35 (Concedida), 16 (Concedida) y 9 (Concedida)	Banco Bilbao Vizcaya Argentaria Uruguay S.A.	94

N° Exp	Resolución	Marca	Clases	Titular	Ag.
			(Concedida)		
522683	10/08/2022	HOSHIZAKI (mixta)	11 (Concedida S/D)	HOSHIZAKI CORPORATION	194
522684	11/08/2022	TERRAZAS DE LOS HORNEROS	37 (Concedida) y 36 (Concedida)	MAURICIO LABUONORA	194
522689	16/08/2022	HIPRA	44 (Concedida S/D), 42 (Concedida S/D), 10 (Concedida S/D), 9 (Concedida S/D) y 1 (Concedida S/D)	LABORATORIOS HIPRA S.A.	245
522690	10/08/2022	HYBRID	3 (Concedida S/D)	Dr. Kurt Wolff GmbH & Co. KG	219
522693	10/08/2022	ALPECIN HYBRID (mixta)	3 (Concedida S/D)	Dr. Kurt Wolff GmbH & Co. KG	219
522700	10/08/2022	GREEN PEA (mixta)	43 (Concedida S/D), 41 (Concedida S/D) y 35 (Concedida S/D)	Eataly Real Estate S.r.l.	144
522701	19/08/2022	LES HOTELIERS (mixta)	41 (Concedida) y 35 (Concedida)	Angela De Vitta	
522711	10/08/2022	VICTORIA COSSI LINGERIE (mixta)	25 (Concedida S/D) y 3 (Concedida S/D)	Pasyco SRL	
522722	16/08/2022	LOS SORCHANTES 1898 EL PAN NUESTRO DE CADA DIA	30 (Concedida S/D)	Panificadora Bimbo del Uruguay S.A.	
522723	16/08/2022	RESONANCIA RADIANTE (mixta)	44 (Concedida S/D)	Gabriela Reig	
522724	16/08/2022	DE NUESTRAS TIERRAS A TU MESA	30 (Concedida)	Panificadora Bimbo del Uruguay S.A.	181
522725	16/08/2022	LAVEYA ! LAVADEROS PREPAGO (mixta)	37 (Concedida)	Gerardo Montes de Oca	
522732	16/08/2022	BREAK (mixta)	9 (Concedida)	Valentina de Souza Soto	212
522735	16/08/2022	IBERONEX IBERO INTERNATIONAL HIGHER EDUCATION (mixta)	41 (Concedida S/D)	POLARIS MINOR, S.L. SOCIEDAD UNIPERSONAL	144
522744	16/08/2022	SAMEL (mixta)	44 (Concedida)	SÁEZ MARTIRENA LUCÍA BEATRIZ	212
522745	16/08/2022	COVID SAFE ACCOMMODATION	41 (Concedida S/D)	Consuhotel, S.A.	218

N° Exp	Resolución	Marca	Clases	Titular	Ag.
		CONSUHOTEL (mixta)			
522746	16/08/2022	MARADENTRO PUNTA DEL DIABLO (mixta)	43 (Concedida)	GURLAND S.R.L.	194
522747	16/08/2022	BURGERFI	43 (Concedida) y 30 (Concedida)	BurgerFi IP, LLC	212
522748	16/08/2022	ELZONRIS	5 (Concedida S/D)	Stemline Therapeutics, Inc.	245
522749	16/08/2022	MARADENTRO PUNTA DEL DIABLO (mixta)	43 (Concedida)	GURLAND S.R.L.	194
522750	16/08/2022	DAILY ACCESS (mixta)	12 (Concedida S/D)	IVECO S.P.A.	34
522751	16/08/2022	ORAL-B DUPLO ALIVIO	3 (Concedida S/D)	The Gillette Company LLC	212
522752	16/08/2022	M A (mixta)	43 (Concedida)	GURLAND S.R.L.	194
522753	16/08/2022	CONTI CREDITOS (mixta)	36 (Concedida)	FRANCIS CONTI ALBIN	216
522754	16/08/2022	ZENTIDOS (mixta)	44 (Concedida)	BERCUNCHELLI BULA, MONICA PATRICIA	212
522755	16/08/2022	SOUTHGENOMICS	35 (Concedida S/D)	Washington Rodriguez	
522756	16/08/2022	HOMECONCIERGE CUIDAMOS TU INDEPENDENCIA (mixta)	45 (Concedida), 36 (Concedida) y 35 (Concedida)	GBA S.A.	212
522759	16/08/2022	CAPUCCINA PASTELERÍA (mixta)	43 (Concedida S/D)	Florencia Carabajal	
522766	16/08/2022	OPTICASMU (mixta)	44 (Concedida), 35 (Concedida) y 9 (Concedida)	CASMU INSTITUCION DE ASISTENCIA MEDICA PRIVADA DE PROFESIONALES SIN FINES DE LUCRO	220
522768	16/08/2022	COCINA LIBRE	43 (Concedida S/D)	Maria Isabel Sintas Pagano	
522779	16/08/2022	FRESHFICACIA	3 (Concedida S/D)	COLGATE-PALMOLIVE COMPANY	201
522784	16/08/2022	SWISS RE	42 (Concedida S/D), 41 (Concedida S/D), 36 (Concedida S/D), 35 (Concedida S/D), 16 (Concedida S/D) y 9 (Concedida S/D)	Swiss Re Ltd	216
522787	16/08/2022	ALLTAK (mixta)	16 (Concedida)	GRUPO GRAFENO S.A.S.	201
522790	16/08/2022	(figurativa)	5 (Concedida S/D)	OTSUKA PHARMACEUTICAL Co., Ltd.	34

N° Exp	Resolución	Marca	Clases	Titular	Ag.
522792	16/08/2022	GLÁ	1 (Concedida)	Miguel Stratta	
522793	16/08/2022	VONIX (mixta)	3 (Concedida)	GRUPO GRAFENO S.A.S.	201
522796	16/08/2022	CLOSE - UP INTERNATIONAL (mixta)	42 (Concedida S/D), 35 (Concedida S/D) y 9 (Concedida S/D)	PRESCRIPTION DATA AG	34
522798	16/08/2022	NUTRAMENT	32 (Concedida S/D)	Harvest Hill Beverage Company	34
522799	16/08/2022	WING IT! (mixta)	16 (Concedida S/D)	Delivery Hero SE	34
522801	12/08/2022	PAULINE (mixta)	43 (Concedida) y 30 (Concedida S/D)	EBLO GOURMET S.A.	34
522802	12/08/2022	CONQUER	12 (Concedida S/D)	JIANGLING MOTORS CO., LTD.	34
522804	12/08/2022	JMC CARRYING	12 (Concedida S/D)	JIANGLING MOTORS CO., LTD.	34
522807	12/08/2022	SERENDIPIA (mixta)	41 (Concedida)	SERENDIPIA S.A.S.	201
522808	12/08/2022	MERCADOLÍDER (mixta)	35 (Concedida)	MercadoLibre Inc.	94
522811	12/08/2022	VIAPOL	19 (Concedida S/D) y 17 (Concedida S/D)	VIAPOL LTDA	34
522813	12/08/2022	A AZORA (mixta)	43 (Concedida S/D), 37 (Concedida S/D) y 36 (Concedida S/D)	AZORA CAPITAL, S.L.	144
522816	29/08/2022	COLONIA EL ALA ESTE DE COLONIA (mixta)	36 (Concedida S/D)	ALA ESTE SAS	94
522818	29/08/2022	OÍR MÁS + (mixta)	10 (Concedida) y 9 (Concedida)	AUDICAL SRL	144
522830	29/08/2022	(figurativa)	36 (Concedida S/D)	BANCO SANTANDER S.A.	194
522831	29/08/2022	COALIX (mixta)	3 (Concedida)	COALIX S.A.	144
522834	29/08/2022	MOVEQUIP (mixta)	28 (Concedida)	GCU S.A.	219
522841	29/08/2022	PLANTUR	5 (Concedida S/D) y 3 (Concedida S/D)	Dr. Kurt Wolff GmbH & Co. KG	219
522844	29/08/2022	LYUMJEV	5 (Concedida S/D)	Eli Lilly and Company	194
522845	29/08/2022	JUST FOR SPORT JFS (mixta)	35 (Concedida) y 25	SUNFER S.A.	201

N° Exp	Resolución	Marca	Clases	Titular	Ag.
			(Concedida)		
522846	29/08/2022	VERZENIO	5 (Concedida S/D)	Eli Lilly and Company	194
522847	29/08/2022	BP BLOSSOMPHARMA (mixta)	5 (Concedida) y 3 (Concedida)	WAKSUL S.A.	194
522848	29/08/2022	SOW NATURAL SALON (mixta)	3 (Concedida)	DUNA ENTERPRISES S.L.	144
522849	29/08/2022	CYRAMZA	5 (Concedida S/D)	Eli Lilly and Company	194
522850	29/08/2022	IT ITECH INTERNATIONAL TECHNOLOGY (mixta)	42 (Concedida)	ITECH COM SAS	186
522853	29/08/2022	BLEM CUIDADO EXPERTO	3 (Concedida S/D)	S. C. JOHNSON & SON, INC.	194
522854	29/08/2022	LATIN EQUIPMENT (mixta)	35 (Concedida)	LATIN EQUIPMENT URUGUAY S.A.	201
522903	11/08/2022	CONTOUR	20 (Concedida)	INTERMARK LTDA.	201
522905	18/08/2022	POWER LEGS	10 (Concedida)	INTERMARK LTDA.	201
522906	11/08/2022	GREENBAG	16 (Concedida S/D)	SUZANO S.A.	34
522907	15/08/2022	HEALTHY STEPS	25 (Concedida)	INTERMARK LTDA.	201
522909	11/08/2022	GREENBAG (mixta)	16 (Concedida S/D)	SUZANO S.A.	34
522911	11/08/2022	GREENBAG (mixta)	16 (Concedida S/D)	SUZANO S.A.	34
522913	11/08/2022	DADE (mixta)	35 (Concedida) y 25 (Concedida)	DOLORES de ARTEAGA HUGHES	144
522914	15/08/2022	GREENBAG (mixta)	16 (Concedida S/D)	SUZANO S.A.	34
522916	29/08/2022	CULTURA CAFÉ (mixta)	43 (Concedida S/D)	Riccone Rodriguez Juan Pablo	144
522918	11/08/2022	TRANSHOTEL LTDA (mixta)	39 (Concedida) y 35 (Concedida)	TRANSHOTEL LIMITADA	
522920	11/08/2022	LUOKET	21 (Concedida)	INTERMARK LTDA.	201
522921	11/08/2022	SIO (mixta)	6 (Concedida S/D)	NINGBO SIO FLUID EQUIPMENT CO., LTD.	144
522922	11/08/2022	DÍA DE LAS PIEDRAS	35 (Concedida)	CENTRO COMERCIAL E INDUSTRIAL DE LAS PIEDRAS	212
522923	11/08/2022	NEUROBIÓN	5 (Concedida S/D)	P&G Health Germany GmbH	212
522924	11/08/2022	RENUEE	24 (Concedida) y 20 (Concedida)	INTERMARK LTDA.	201
522925	11/08/2022	(figurativa)	3 (Concedida S/D)	JOHNSON & JOHNSON	194

<b>N° Exp</b>	<b>Resolución</b>	<b>Marca</b>	<b>Clases</b>	<b>Titular</b>	<b>Ag.</b>
522926	11/08/2022	VOCOIR	21 (Concedida), 11 (Concedida), 9 (Concedida), 7 (Concedida) y 6 (Concedida)	INTERMARK LTDA.	201
522927	11/08/2022	CROBAO	28 (Concedida)	INTERMARK LTDA.	201
522928	16/08/2022	HAPPY NAPPERS	24 (Concedida) y 20 (Concedida)	Jay At Play International Hong Kong Limited	144
522929	16/08/2022	OPENPAY (mixta)	42 (Concedida S/D), 36 (Concedida S/D) y 9 (Concedida S/D)	Openpay S.A. de C.V.	245
522931	11/08/2022	EXPAREL	5 (Concedida)	Pacira Pharmaceuticals, Inc.	194
522932	15/08/2022	BOSS (mixta)	35 (Concedida S/D), 25 (Concedida S/D), 24 (Concedida S/D), 18 (Concedida S/D), 16 (Concedida S/D), 14 (Concedida S/D) y 9 (Concedida S/D)	HUGO BOSS Trade Mark Management GmbH & Co. KG	144
522933	15/08/2022	HUGO BOSS (mixta)	35 (Concedida S/D) y 16 (Concedida S/D)	HUGO BOSS Trade Mark Management GmbH & Co. KG	144
522934	15/08/2022	BOSS (mixta)	35 (Concedida S/D), 25 (Concedida S/D), 21 (Concedida S/D), 18 (Concedida S/D) y 12 (Concedida S/D)	HUGO BOSS Trade Mark Management GmbH & Co. KG	144
522935	16/08/2022	FINOTECH (mixta)	1 (Concedida S/D)	HANGZHOU ZHIJIANG SILICONE CHEMICALS CO., LTD.	212
522936	15/08/2022	RECONNECTADAS (mixta)	41 (Concedida)	Alejandra Silvana Labraga Arbelo	232



N° Exp	Resolución	Marca	Clases	Titular	Ag.
522938	16/08/2022	MUNDO REGALOS (mixta)	35 (Concedida S/D)	Soledad Calabuig	
522939	11/08/2022	FAMAX	3 (Concedida S/D)	Daniel Moizo Cassou	
522940	11/08/2022	(figurativa)	41 (Concedida S/D) y 36 (Concedida S/D)	SOS Kinderdorf	219
522942	18/08/2022	SUMMIT ECP BKS	40 (Concedida S/D) y 9 (Concedida S/D)	Hoya Corporation	192
522943	16/08/2022	SUMMIT CD BKS	40 (Concedida S/D) y 9 (Concedida S/D)	Hoya Corporation	192
522945	15/08/2022	QPARIK	44 (Concedida S/D), 16 (Concedida S/D) y 5 (Concedida S/D)	Incyte Holdings Corporation	212
522947	16/08/2022	24/7 BUENOS AIRES (mixta)	25 (Concedida S/D)	lucia gonzalez aguirre zabala	
522948	15/08/2022	VABYSMO	5 (Concedida S/D)	F. Hoffmann-La Roche AG	201
522950	16/08/2022	LOS CERROS DE SAN JUAN	29 (Concedida)	SENFOR S.A.	201
522954	15/08/2022	(figurativa)	39 (Concedida S/D)	Baerbergh Holding B.V.	216
522956	16/08/2022	STARCK	11 (Concedida S/D) y 9 (Concedida S/D)	PHILIPPE STARCK	194
522967	16/08/2022	MYSTERY RANCH	25 (Concedida S/D) y 18 (Concedida S/D)	Mystery Ranch Ltd.	194
522969	16/08/2022	FLEXPORT	42 (Concedida S/D), 39 (Concedida S/D), 36 (Concedida S/D) y 35 (Concedida S/D)	Flexport, Inc.	194
522971	29/08/2022	ARETZBEER (mixta)	32 (Concedida S/D)	BFS GESTÃO DE MARCAS LTDA	217
522972	16/08/2022	(figurativa)	30 (Concedida) y 29 (Concedida)	LOS NIETITOS S.A.	245
522975	16/08/2022	JP JOSELINE PEREIRA (mixta)	25 (Concedida)	Joseline Pereira	
522977	16/08/2022	COREX	28 (Concedida) y 25	GONZALEZ JIMENEZ, EVARISTO ALFREDO	189

N° Exp	Resolución	Marca	Clases	Titular	Ag.
			(Concedida)	y GONZALEZ JIMENEZ, VIRGINIA ELENA	
522978	16/08/2022	AROMO	42 (Concedida)	Lumen Christi SRL	154
522980	29/08/2022	LIVERPOOL	34 (Concedida S/D)	Marcelo Pedro Buffo	220
522981	16/08/2022	KYZIFIC	5 (Concedida S/D)	NOVARTIS AG.	201
522982	16/08/2022	BACRELBA	5 (Concedida S/D)	NOVARTIS AG.	201
522983	16/08/2022	LAUDIS	5 (Concedida S/D)	Bayer Aktiengesellschaft	218
522984	16/08/2022	MEGABRIGHT (mixta)	11 (Concedida)	IMPORTADORA DOWNLIGHT SPA	144
522985	16/08/2022	XIVANA	5 (Concedida S/D)	Bayer Aktiengesellschaft	218
522989	16/08/2022	KAMAZ (mixta)	35 (Concedida S/D) y 12 (Concedida S/D)	KAMAZ Publicly Traded Company	181
522992	16/08/2022	FREEDOM	9 (Concedida S/D)	CPS Technology Holdings LLC	194
522993	16/08/2022	MODIFEYE	10 (Concedida S/D)	Alcon Inc.	194
522995	18/08/2022	MEZCLÁ Y DISFRUTÁ (mixta)	30 (Concedida S/D)	Mondelez Argentina S.A.	227
522997	16/08/2022	QA QUATRO ADVISORS (mixta)	36 (Concedida S/D) y 35 (Concedida S/D)	QUATRO ADVISORS SAS	218
522998	16/08/2022	YUUP (mixta)	3 (Concedida S/D)	COSMETICA VENETA S.R.L.	245
523000	12/08/2022	DOLLARCITY (mixta)	36 (Concedida S/D)	DOLLARCITY HOLDINGS INC.	181
523002	18/08/2022	"VIA PUBLICA UN ESPACIO COMPARTIDO PRODUCE Y CONDUCE MARTIN CLAVIJO" (mixta)	41 (Concedida), 38 (Concedida) y 35 (Concedida)	MARTIN JOSE CLAVIJO CEDRES	168
523003	18/08/2022	(figurativa)	5 (Concedida S/D)	Kimberly-Clark Worldwide, Inc.	201
523009	12/08/2022	LARIFAMOS (mixta)	41 (Concedida)	STRATTA TARRAB, LUIS RODRIGO	201
523012	16/08/2022	G TECH (mixta)	10 (Concedida)	Gonzalo Jesús Da Silva Paiva y NADIA YASMIN MOYANO	220
523015	19/08/2022	KOTEX	25 (Concedida S/D)	Kimberly-Clark Worldwide, Inc.	201
523016	12/08/2022	ENTRE PINTAS (mixta)	43 (Concedida)	CATRIEL SAGARDOY JUAREZ; ALEJANDRO CARDOSO y CARLOS ALBERTO DE BRUN TAJES	228

N° Exp	Resolución	Marca	Clases	Titular	Ag.
523022	18/08/2022	NEXO ABERTURAS R (mixta)	19 (Concedida S/D) y 6 (Concedida S/D)	NEXO S.A.	217
523024	12/08/2022	ONNEA INSPIRACIÓN EN PAPEL (mixta)	35 (Concedida)	Rodrigo Abal Rubio	
523034	12/08/2022	EUDOCOL	5 (Concedida)	BALIARDA S.A.	201
523035	18/08/2022	PICKERS BY MCCAIN	29 (Concedida S/D)	MCCAIN FOODS LIMITED	94
523038	18/08/2022	ALTA D CAL	5 (Concedida)	EUROFARMA URUGUAY S.A.	201
523041	12/08/2022	PAYCOLOR (mixta)	35 (Concedida)	MACRI, MARIA VICTORIA	245
523045	18/08/2022	TCL MICRO LED (mixta)	9 (Concedida S/D)	TCL TECHNOLOGY GROUP CORPORATION	34
523047	16/08/2022	BE POSSIBLE (mixta)	41 (Concedida) y 35 (Concedida)	WYSOKIKAMIEN, CARLOS	201
523048	18/08/2022	ACUVUE EYE HEALTH ADVISOR (mixta)	41 (Concedida S/D), 16 (Concedida S/D) y 9 (Concedida S/D)	JOHNSON & JOHNSON	194
523053	18/08/2022	KIRA (mixta)	9 (Concedida S/D)	Kimberly-Clark Worldwide, Inc.	201
523055	18/08/2022	NUTRIFOODIELAB	44 (Concedida), 41 (Concedida) y 9 (Concedida)	TATIANA SZTRYK	181
523057	12/08/2022	UNIPEGA	17 (Concedida S/D)	EXPRESSU COMÉRCIO IMPORTAÇÃO E EXPORTAÇÃO DE ADESIVOS EIRELI-EPP	212
523058	12/08/2022	CHASE DURER (mixta)	14 (Concedida S/D)	Invicta Watch Company of America, Inc.	212
523060	12/08/2022	WOLIDA	17 (Concedida)	SHENZHEN WOER HEAT-SHRINKABLE MATERIAL CO., LTD.	220
523062	19/08/2022	ESTUDIO MOLINA (mixta)	36 (Concedida) y 35 (Concedida)	MOLINA, MARIO; MOLINA, CECILIA y MOLINA, VICTORIA	189
523064	12/08/2022	NEXIT (mixta)	42 (Concedida) y 9 (Concedida)	Tribol Consultores SRL	232
523066	16/08/2022	VARENS BEAUTE (mixta)	3 (Concedida S/D)	ULRIC DE VARENS SA	144
523067	12/08/2022	MIA SECRET (mixta)	3 (Concedida S/D)	DE ROBLIN, INC.	201
523069	12/08/2022	MIA SECRET (mixta)	3 (Concedida S/D)	DE ROBLIN, INC.	201
523070	12/08/2022	MIA SECRET (mixta)	3 (Concedida S/D)	DE ROBLIN, INC.	201

N° Exp	Resolución	Marca	Clases	Titular	Ag.
523071	12/08/2022	JOLION (mixta)	37 (Concedida S/D), 35 (Concedida S/D) y 12 (Concedida S/D)	GREAT WALL MOTOR COMPANY LIMITED	34
523072	12/08/2022	MIA SECRET (mixta)	3 (Concedida S/D)	DE ROBLIN, INC.	201
523074	12/08/2022	MIA SECRET (mixta)	3 (Concedida S/D)	DE ROBLIN, INC.	201
523075	12/08/2022	MIA SECRET (mixta)	3 (Concedida S/D)	DE ROBLIN, INC.	201
523076	18/08/2022	PLATINO EDUCA PLATAFORMA EDUCATIVA (mixta)	41 (Concedida S/D)	ENTIDAD DE GESTION DE DERECHOS DE LOS PRODUCTORES AUDIOVISUALS (EGEDA)	34
523077	12/08/2022	MIA SECRET (mixta)	3 (Concedida S/D)	DE ROBLIN, INC.	201
523078	12/08/2022	MIA SECRET (mixta)	3 (Concedida S/D)	DE ROBLIN, INC.	201
523080	12/08/2022	MIA SECRET (mixta)	3 (Concedida S/D)	DE ROBLIN, INC.	201
523081	12/08/2022	MIA SECRET (mixta)	3 (Concedida S/D)	DE ROBLIN, INC.	201
523082	16/08/2022	FERROMALLAS	40 (Concedida) y 6 (Concedida)	TDMA S.R.L.	220
523083	16/08/2022	RAPICERC	6 (Concedida)	TDMA S.R.L.	220
523084	16/08/2022	RAPIVALLA	6 (Concedida)	TDMA S.R.L.	220
523085	16/08/2022	SEGURICERC	6 (Concedida)	TDMA S.R.L.	220
523091	18/08/2022	DEMICENTER (mixta)	44 (Concedida)	FEDERICO DEKMAK	186
523092	16/08/2022	VERTO	12 (Concedida S/D)	Specialized Bicycle Components, Inc.	194
523094	18/08/2022	FINE GUARD (mixta)	5 (Concedida S/D)	Nuqul Brothers Company Limited	212
523098	18/08/2022	CREDISHOP	36 (Concedida) y 35 (Concedida)	ALBERTO MARTIN SCASSO VOLONTE	
523105	18/08/2022	PILÁN CREACIONES (mixta)	40 (Concedida) y 25 (Concedida)	María Beatriz Vanoli	220
523107	18/08/2022	CENTRAL PETS (mixta)	35 (Concedida)	JUAN LLAGUEIRO	192
523109	23/08/2022	D DELUXE BLEND (mixta)	34 (Concedida S/D)	DARIO RUBEN IPPOLITO	220
523112	16/08/2022	BRAVA (mixta)	37 (Concedida)	FERREIRA RAMOS, MARTÍN	189
523113	18/08/2022	PUR SANG URUGUAY (mixta)	12 (Concedida)	BAJO EL SAUCE S.A.	220

N° Exp	Resolución	Marca	Clases	Titular	Ag.
523114	18/08/2022	PUR SANG URUGUAY	12 (Concedida)	BAJO EL SAUCE S.A.	220
523119	18/08/2022	ELSA DKT	5 (Concedida S/D)	DKT Uruguay S.A.	94
523121	18/08/2022	OMYAA DKT	5 (Concedida S/D)	DKT Uruguay S.A.	94
523144	18/08/2022	ROMA EXTINTORES SRL (mixta)	9 (Concedida S/D)	ROMA EXTINTORES SRL	
523159	18/08/2022	ZOLGENSMA (mixta)	44 (Concedida S/D) y 5 (Concedida S/D)	NOVARTIS AG.	201
523161	18/08/2022	NOIR (mixta)	3 (Concedida S/D)	Zhejiang Meimi Technology Co., Ltd.	144
523163	18/08/2022	TOPTOY (mixta)	35 (Concedida S/D), 28 (Concedida S/D), 26 (Concedida S/D), 16 (Concedida S/D), 14 (Concedida S/D) y 9 (Concedida S/D)	MINISO (Hengqin) Enterprise Management Co., Ltd.	125
523164	18/08/2022	DULCE AVENTURA (mixta)	30 (Concedida)	PAMPA GLOBAL TRADE S.A.	201
523165	18/08/2022	DIVERGENTE (mixta)	25 (Concedida)	Sandra Celina RODRIGUEZ BARRERO	168
523168	18/08/2022	RAES INVERSIONES.COM (mixta)	36 (Concedida S/D)	GRUPO INVERSIONES SRL	34
523169	18/08/2022	WYRKEL QUÍMICA EN CONCRETO (mixta)	35 (Concedida) y 1 (Concedida)	WYRKEL S.A.	201
523175	18/08/2022	BEYOND BACON	29 (Concedida S/D)	Beyond Meat, Inc.	201
523176	18/08/2022	DD DULCEMANIA S.R.L. (mixta)	35 (Concedida)	DULCEMANÍA S.R.L.	189
523177	18/08/2022	MO MA	21 (Concedida S/D)	Yanila Fajardo	
523178	19/08/2022	MERAKI	35 (Concedida S/D) y 25 (Concedida)	Ecoclass SAS	212
523179	19/08/2022	SENSABITS SMART SENSOR PLATAFORM (mixta)	42 (Concedida S/D)	SILVEIRA CASTELLS FELIPE EDUARDO, LOPEZ CRUCHINSKI RODRIGO DAVID Y OTROS SOCIEDAD DE HECHO	
523196	18/08/2022	BRB (mixta)	27 (Concedida)	CYMACO S.A.	154
523200	19/08/2022	UNICOL (mixta)	27 (Concedida)	CYMACO S.A.	154
523218	19/08/2022	MAHMOOD RICE (mixta)	30 (Concedida S/D)	ALTUNKAYA INSAAT NAKLIYAT GIDA TICARET ANONIM SIRKETI	34
523223	19/08/2022	NEOPAN (mixta)	10 (Concedida S/D)	NEOPAN DO BRASIL LTDA	34

<b>N° Exp</b>	<b>Resolución</b>	<b>Marca</b>	<b>Clases</b>	<b>Titular</b>	<b>Ag.</b>
523225	29/08/2022	BEON TECH STUDIO (mixta)	42 (Concedida S/D)	WASSERMAN, DAMIAN y COHEN, CARLOS MICHEL	34
523227	29/08/2022	MUJERES CELESTES (mixta)	41 (Concedida)	Andrea Valiente	
523228	29/08/2022	ROSAFE PREMIUM (mixta)	29 (Concedida S/D)	Avicola Rosafe SAS	
523230	29/08/2022	HONOR	14 (Concedida)	Honor Device Co., Ltd.	201
523232	29/08/2022	DE LA GATA SURF (mixta)	35 (Concedida), 28 (Concedida) y 25 (Concedida)	MARIANA FELIX CARMENES	168
523234	29/08/2022	BOOL REE (mixta)	8 (Concedida) y 7 (Concedida)	KANTIRA S.A.	220
523268	29/08/2022	DISA URUGUAY (mixta)	39 (Concedida S/D), 35 (Concedida S/D), 4 (Concedida S/D) y 1 (Concedida S/D)	DISA HOLDING ENERGÉTICO, S.L.U.	144
523271	29/08/2022	GENROD R (mixta)	17 (Concedida) y 9 (Concedida)	GEN ROD S.A.	144
523273	29/08/2022	CLINICA DE LOS HORNEROS	44 (Concedida)	ALBINCO S.A.	34
523274	29/08/2022	HPRT (mixta)	9 (Concedida S/D) y 7 (Concedida S/D)	XIAMEN HANIN ELECTRONIC TECHNOLOGY CO., LTD.	34
523275	29/08/2022	FV FEDEVALVERDE (mixta)	32 (Concedida), 28 (Concedida), 25 (Concedida), 16 (Concedida) y 3 (Concedida)	Federico Santiago Valverde Dipetta	186
523276	29/08/2022	EPOS (mixta)	14 (Concedida S/D)	Epos Uhren AG (Epos Montres SA)	192
523277	29/08/2022	PREDATOR (mixta)	35 (Concedida), 28 (Concedida), 20 (Concedida) y 9 (Concedida)	Acer Incorporated	181
523283	29/08/2022	BUFFET FOOD SERVICE (mixta)	35 (Concedida)	HENDERSON & CIA. S.A.	181
523290	29/08/2022	BOYERO	9 (Concedida)	Valls S.A.	218

<b>N° Exp</b>	<b>Resolución</b>	<b>Marca</b>	<b>Clases</b>	<b>Titular</b>	<b>Ag.</b>
523295	29/08/2022	(figurativa)	37 (Concedida S/D) y 12 (Concedida S/D)	SPBI	201
523297	29/08/2022	MUECA FILMS	41 (Concedida S/D)	Mueca Films SRL	
523303	19/08/2022	HABILIDADES PARA LA VIDA (mixta)	45 (Concedida), 44 (Concedida), 42 (Concedida) y 41 (Concedida)	Deloitte Sociedad Civil	144
523307	18/08/2022	AULO GELIO (mixta)	3 (Concedida)	LABORATORIOS FELIPE BAJER S.A.I.C.	201
523309	18/08/2022	REP (mixta)	3 (Concedida)	LABORATORIOS FELIPE BAJER S.A.I.C.	201
523313	18/08/2022	AULIO GELIO	3 (Concedida)	LABORATORIOS FELIPE BAJER S.A.I.C.	201
523317	19/08/2022	TECNIS SYMFONY	10 (Concedida S/D)	Johnson & Johnson Surgical Vision, Inc.	194
523319	19/08/2022	FARM-X (mixta)	5 (Concedida) y 3 (Concedida)	LABORATORIOS FELIPE BAJER S.A.I.C.	201
523321	19/08/2022	LABORATORIOS FELIPE BAJER MÁS DE 60 AÑOS AL SERVICIO DE LA SALUD (mixta)	5 (Concedida) y 3 (Concedida)	LABORATORIOS FELIPE BAJER S.A.I.C.	201
523322	19/08/2022	PICOLAX GADOR	5 (Concedida)	LABORATORIO GADOR S.A.	165
523324	18/08/2022	APIFORT	3 (Concedida)	APITER S.A.	212
523328	18/08/2022	DATAMARS	42 (Concedida S/D), 35 (Concedida S/D), 10 (Concedida S/D) y 9 (Concedida S/D)	DATAMARS SA	34
523330	18/08/2022	DOBOT	9 (Concedida S/D)	ShenZhen YueJiang Technology Co.,Ltd.	28
523333	18/08/2022	GUENOA (mixta)	30 (Concedida)	JOSÉ ARTURO ASHFIELD BETANCOR Y LUCÍA VICTORIA CABRERA GOMEZ SOCIEDAD DE HECHO	
523335	19/08/2022	CONSCIENTE...TÉ BY SUSANA GUANCO (mixta)	3 (Concedida S/D)	Susana Alicia Guanco Lorenzo	
523338	29/08/2022	NEURAÍZ NEUROCIENCIA	44 (Concedida) y 41	VIEYTES, MARÍA SOLEDAD	189

N° Exp	Resolución	Marca	Clases	Titular	Ag.
		PERIFAMILIAR (mixta)	(Concedida)		
523339	19/08/2022	IMPACTO (mixta)	35 (Concedida S/D)	JAFFE, BRIAN	189
523340	19/08/2022	DONMARCA DAMOS VALOR A TUS IDEAS (mixta)	45 (Concedida)	DAMIAN FERRERO	220
523342	23/08/2022	CARGOBOX	39 (Concedida)	Juan Pablo Lopez Sarasua	
523348	23/08/2022	SMARTSEE	44 (Concedida S/D), 16 (Concedida S/D), 10 (Concedida S/D) y 9 (Concedida S/D)	Ulthera, Inc.	144
523351	29/08/2022	LLEEGO TRAVEL MARKET (mixta)	9 (Concedida S/D)	LLEEGO TRAVEL MARKET, S.L.	144
523352	19/08/2022	COVERLAM	19 (Concedida S/D)	GRESPANIA, S.A.	144
523353	29/08/2022	POLO EARTH RALPH LAUREN (mixta)	3 (Concedida S/D)	THE POLO/LAUREN COMPANY, L.P.	144
523355	29/08/2022	333 ESTD 1875 (mixta)	32 (Concedida S/D)	SAIGON BEER – ALCOHOL – BEVERAGE CORPORATION	34
523360	23/08/2022	FUNDACION US MEM (mixta)	41 (Concedida)	FUNDACION US MEM	34
523361	29/08/2022	VÉNETO COMFORT E PIACERE (mixta)	11 (Concedida) y 7 (Concedida)	Cirecar S.A.	218
523362	19/08/2022	EXROPA	38 (Concedida) y 25 (Concedida)	Gabriel Devia	
523364	29/08/2022	SCOUT ROGUE	12 (Concedida S/D)	Indian Motorcycle International, LLC	201
523365	19/08/2022	DOÑA ANGELITA (mixta)	35 (Concedida) y 30 (Concedida)	VARELA VOLPE, SUSANA LIDIA y GONZÁLEZ CANO, ALICIA	189
523366	29/08/2022	LA CANNOLERIA PASTELERIA Y CREMERIA TRADICIÓN FAMILIAR (mixta)	30 (Concedida S/D)	Romina Flavia Spinelli Ranero	
523372	29/08/2022	TREBOL BATERÍAS (mixta)	9 (Concedida S/D)	FULVIER S.A.	136
523374	23/08/2022	GRUPO BARRIOLA (mixta)	39 (Concedida) y 37 (Concedida)	Rodrigo Barriola	126
523376	19/08/2022	LYOFAST	1 (Concedida S/D)	Sacco S.r.l.	201
523378	19/08/2022	METHOD	5 (Concedida S/D)	METHOD PRODUCTS PBC	194



N° Exp	Resolución	Marca	Clases	Titular	Ag.
523381	29/08/2022	FERRO MALLAS (mixta)	40 (Concedida) y 6 (Concedida)	TDMA S.R.L.	220
523383	19/08/2022	GONKY (mixta)	28 (Concedida)	DIEGO ALFREDO VARELA ROSSI y GUSTAVO DANIEL CURUTCHAGUE CARRIQUIRY	144
523385	19/08/2022	VIRANTRA	5 (Concedida S/D)	SYNGENTA CROP PROTECTION AG	194
523386	19/08/2022	GLF (mixta)	35 (Concedida), 30 (Concedida) y 29 (Concedida)	I.F.S. International Food Services and Partners S.r.l.	194
523390	19/08/2022	CORDIVARI	11 (Concedida S/D)	CORDIVARI S.R.L.	144
523391	23/08/2022	ABU GARCIA	28 (Concedida S/D)	Abu AB	194
523392	23/08/2022	BERKLEY	28 (Concedida S/D)	Pure Fishing, Inc.	194
523394	19/08/2022	FIN NOR	28 (Concedida S/D)	Pure Fishing, Inc.	194
523396	29/08/2022	LOS CERROS DE SAN JUAN	35 (Concedida)	SENFOR S.A.	201
523401	19/08/2022	HIPRA	35 (Concedida S/D)	LABORATORIOS HIPRA S.A.	245
523403	19/08/2022	SALAMANCA (mixta)	32 (Concedida) y 30 (Concedida)	TA -TA S.A.	245
523405	16/08/2022	CORTÁ TU DEUDA (mixta)	36 (Concedida)	Alan Saps; Juan Ignacio Fernandez y Maximiliano Otermin	220
523414	19/08/2022	AURIX	5 (Concedida S/D)	KÖNIG URUGUAY SOCIEDAD ANONIMA	129
523417	19/08/2022	DESE0'S	5 (Concedida)	MEDEROS RUIZ, MARY ESTHER	189
523418	19/08/2022	MORLAN	34 (Concedida)	ZUBERI S.A.	189
523422	19/08/2022	FRAMAR	26 (Concedida S/D), 21 (Concedida S/D), 16 (Concedida S/D) y 9 (Concedida S/D)	FRAMAR INTERNATIONAL, INC.	218
523431	19/08/2022	AMBANDHA	38 (Concedida S/D)	Shanghai Spacecom Satellite Technology Ltd.	94
523432	16/08/2022	(figurativa)	38 (Concedida S/D)	Shanghai Spacecom Satellite Technology Ltd.	94
523433	19/08/2022	FERMATA MUSIC (mixta)	35 (Concedida)	GUILLERMO FREIJIDO PAOLILLO	105
523441	19/08/2022	QUICK-STEP	27 (Concedida S/D) y 19 (Concedida)	UNILIN B.V.	216

N° Exp	Resolución	Marca	Clases	Titular	Ag.
			S/D)		
523442	19/08/2022	OPAL (mixta)	22 (Concedida S/D) y 16 (Concedida S/D)	Paper Australia Pty Ltd	34
523443	19/08/2022	TIVDAK	42 (Concedida S/D) y 5 (Concedida S/D)	Seagen Inc.	194
523446	19/08/2022	QUICK-STEP FLOOR DESIGNERS (mixta)	27 (Concedida S/D) y 19 (Concedida S/D)	UNILIN B.V.	216
523448	19/08/2022	POTENZA (mixta)	7 (Concedida)	R. BALAGUER S.A.	34
523451	19/08/2022	LIVYN	27 (Concedida S/D) y 19 (Concedida S/D)	UNILIN B.V.	216
523455	19/08/2022	UNICLIC	27 (Concedida S/D) y 19 (Concedida S/D)	Unilin Beheer B.V.	216
523457	19/08/2022	UNILIN (mixta)	19 (Concedida S/D)	UNILIN B.V.	216
523459	19/08/2022	BUON MANGIARE (mixta)	30 (Concedida) y 29 (Concedida)	TA -TA S.A.	245
523463	19/08/2022	CARBEN PARE (mixta)	37 (Concedida)	ARTIGAS CORDOBA, ROGELIO HUGO	245
523465	19/08/2022	CARIZIC	5 (Concedida)	ZODIAC INTERNATIONAL CORPORATION	245
523466	19/08/2022	CENOTEM	5 (Concedida)	ZODIAC INTERNATIONAL CORPORATION	245
523467	19/08/2022	BREPIZIC	5 (Concedida)	ZODIAC INTERNATIONAL CORPORATION	245
523468	19/08/2022	JALZERMET	5 (Concedida)	ZODIAC INTERNATIONAL CORPORATION	245
523469	19/08/2022	SIBINTAMET	5 (Concedida)	ZODIAC INTERNATIONAL CORPORATION	245
523470	19/08/2022	T TELEFÓNICA (mixta)	42 (Concedida S/D), 41 (Concedida S/D), 38 (Concedida S/D), 35 (Concedida S/D) y 9 (Concedida S/D)	TELEFONICA, S.A.	201
523471	19/08/2022	VENTUS NOS IMPORTA EL FUTURO	36 (Concedida)	VENTUS ENERGIA S.A.	201

N° Exp	Resolución	Marca	Clases	Titular	Ag.
		(mixta)			
523472	19/08/2022	T&G	9 (Concedida)	PEPEGANGA S.A.	189
523475	19/08/2022	PERLATTE	5 (Concedida)	EUROFARMA URUGUAY S.A.	201
523476	19/08/2022	COGMAX	5 (Concedida)	EUROFARMA URUGUAY S.A.	201
523487	19/08/2022	CERVEZA TOÑA LIGHT NICARAGUA (mixta)	32 (Concedida S/D)	Inversiones Cerveceras Centroamericanas, S.A.	217
523488	22/08/2022	CERVEZA HALCÓN PEREGRINO CONTENIDO NETO: 350ML. 4,9% ALC./VOL. (mixta)	32 (Concedida S/D)	Inversiones Cerveceras Centroamericanas, S.A	217
523492	19/08/2022	IDOLE AURA (mixta)	3 (Concedida S/D)	L'OREAL	144
523496	29/08/2022	SCOUTS CONSTRUIR UN MUNDO MEJOR (mixta)	41 (Concedida) y 35 (Concedida)	Movimiento Scout del Uruguay	101
523497	22/08/2022	MOVIMIENTO SCOUT DEL URUGUAY (mixta)	41 (Concedida) y 35 (Concedida)	Movimiento Scout del Uruguay	101
523498	16/08/2022	(figurativa)	41 (Concedida) y 35 (Concedida)	Movimiento Scout del Uruguay	101
523500	19/08/2022	TODOPLATA	36 (Concedida)	SUCONEL S.A.	129
523503	23/08/2022	ARC	42 (Concedida S/D) y 9 (Concedida S/D)	INTEL CORPORATION	245
523504	19/08/2022	HELIX	42 (Concedida S/D) y 9 (Concedida S/D)	JNT Systems, Inc.	245
523508	19/08/2022	RIVJOI	5 (Concedida S/D)	NOVARTIS AG.	201
523513	19/08/2022	VITASAN	3 (Concedida)	EBROMAR S.A.	144
523516	19/08/2022	LIBRELA	5 (Concedida S/D)	Zoetis Services LLC	194
523517	29/08/2022	TOTALENERGIES (mixta)	40 (Concedida S/D), 39 (Concedida S/D), 37 (Concedida S/D), 9 (Concedida S/D), 7 (Concedida S/D), 4 (Concedida S/D) y 1 (Concedida S/D)	TotalEnergies SE	201

N° Exp	Resolución	Marca	Clases	Titular	Ag.
523520	30/08/2022	GENOXIDIL (mixta)	5 (Concedida S/D)	OSCAR HUMBERTO HERNANDEZ GARCÍA.	212
523521	29/08/2022	NBN LIVING (mixta)	3 (Concedida)	OSCAR HUMBERTO HERNANDEZ GARCÍA.	212
523522	29/08/2022	NBN LIVING (mixta)	35 (Concedida S/D)	OSCAR HUMBERTO HERNANDEZ GARCÍA.	212
523523	29/08/2022	NBN LIVING (mixta)	5 (Concedida S/D)	OSCAR HUMBERTO HERNANDEZ GARCÍA.	212
523524	19/08/2022	COLPOESTRIENE	5 (Concedida S/D)	LABORATORIOS TEMIS LOSTALÓ S.A.	192
523525	29/08/2022	INTERNOVA TRAVEL GROUP	43 (Concedida S/D), 39 (Concedida S/D) y 35 (Concedida S/D)	Travel Leaders Group Holdings, LLC	192
523527	19/08/2022	PEPPOS.COM.UY (mixta)	35 (Concedida)	Susana Cynowicz	220
523528	29/08/2022	INTERNOVA TRAVEL GROUP (mixta)	43 (Concedida S/D), 39 (Concedida S/D) y 35 (Concedida S/D)	Travel Leaders Group Holdings, LLC	192
523530	22/08/2022	THE FLASH	28 (Concedida S/D), 26 (Concedida S/D), 24 (Concedida S/D), 21 (Concedida S/D), 18 (Concedida S/D), 14 (Concedida S/D) y 9 (Concedida S/D)	DC Comics	192
523531	19/08/2022	BORDONIX (mixta)	37 (Concedida), 9 (Concedida), 6 (Concedida) y 2 (Concedida)	Bordonix SA	220
523540	19/08/2022	ORAL-B IO (mixta)	21 (Concedida S/D)	The Gillette Company LLC	212
523541	29/08/2022	THERMAL GRIZZLY	11 (Concedida S/D), 9 (Concedida S/D) y 1 (Concedida S/D)	Thermal Grizzly Holding GmbH	240
523545	19/08/2022	DELTISONA	5 (Concedida)	LABORATORIO ELEA PHOENIX S.A.	34
523550	29/08/2022	URUSMILE	44 (Concedida)	GABRIELA FERNÁNDEZ CERON	104

N° Exp	Resolución	Marca	Clases	Titular	Ag.
523551	23/08/2022	ICON+ (mixta)	37 (Concedida), 17 (Concedida) y 6 (Concedida)	EBS S.A.	220
523552	29/08/2022	CREDIOFERTAS (mixta)	36 (Concedida) y 35 (Concedida)	TIMALE S.R.L.	201
523554	29/08/2022	(figurativa)	35 (Concedida) y 25 (Concedida)	Mauro Magnou	
523561	19/08/2022	BLOCAMINE	5 (Concedida)	LAFEDAR S.A.	217
523563	19/08/2022	FOSMICYN	5 (Concedida)	LAFEDAR S.A.	217
523564	19/08/2022	SPECTREX	5 (Concedida S/D)	LAFEDAR S.A.	217
523565	19/08/2022	SOLENSIA	5 (Concedida S/D)	Zoetis Services LLC	194
523566	19/08/2022	(figurativa)	12 (Concedida S/D)	Loncin Motor Co., Ltd.	94
523568	22/08/2022	TOPSY (mixta)	25 (Concedida)	ENTRA Y SALE IMPORTACION Y EXPORTACION S.R.L	212
523569	22/08/2022	VETTER (mixta)	25 (Concedida)	ENTRA Y SALE IMPORTACION Y EXPORTACION S.R.L	212
523570	29/08/2022	MOONCAKES (mixta)	30 (Concedida S/D)	Verónica Echeverría de León	
523571	29/08/2022	UNIMOD UNIÓN MODULAR (mixta)	6 (Concedida)	Azzollini Construcciones SRL	220
523584	22/08/2022	MYSS SENSUEL (mixta)	25 (Concedida) y 3 (Concedida)	HERRERA ALBERTI, LOURDES SABRINA	201
523586	23/08/2022	VALO	36 (Concedida) y 35 (Concedida)	WODTAX S.A. (en proceso de cambio de nombre a VALORES ADMINISTRADORA DE FONDOS DE INVERSIÓN Y FIDEICOMISOS S.A.)	94
523587	23/08/2022	VALO (mixta)	36 (Concedida) y 35 (Concedida)	WODTAX S.A. (en proceso de cambio de nombre a VALORES ADMINISTRADORA DE FONDOS DE INVERSIÓN Y FIDEICOMISOS S.A.)	94
523588	29/08/2022	ALCANCE CUIDA KIDS (mixta)	45 (Concedida)	MARIA INES GARCÍA ÁLVAREZ	192
523591	29/08/2022	TIRIZ D	5 (Concedida)	EUROFARMA URUGUAY S.A.	201
523599	29/08/2022	DURACRYL ACRYLIC NAIL	3 (Concedida S/D)	Productora y Comercializadora Odontológica	216

N° Exp	Resolución	Marca	Clases	Titular	Ag.
		SYSTEM (mixta)		New Stetic S.A.	
523600	29/08/2022	NEW STETIC 3D ACRYLIC PRINTING RESIN (mixta)	5 (Concedida S/D)	Productora y Comercializadora Odontológica New Stetic S.A.	216
523601	29/08/2022	THE LAB STORE (mixta)	35 (Concedida) y 10 (Concedida)	URTA CANTU AGUSTINA Y BARRERA HURTADO NATALIBETH DE LA SANTISIMATRINIDAD SOCIEDAD DE HECHO	244
523609	29/08/2022	MANGUSI R EL AGUA A TU ALCANCE. (mixta)	37 (Concedida S/D)	Mauro Mangusi	
523610	29/08/2022	TEJIENDO A OSCURAS (mixta)	25 (Concedida S/D)	MARIA ANGELICA GONZALEZ	
523612	29/08/2022	EMIC (mixta)	12 (Concedida)	Sergio Antonio Gallardo	212
523614	29/08/2022	CH CHATEAU BRAVA PUNTA DEL ESTE (mixta)	37 (Concedida) y 36 (Concedida)	NELPINAR SOCIEDAD ANÓNIMA	189
523615	29/08/2022	CH CHATEAU MANSO PUNTA DEL ESTE (mixta)	37 (Concedida) y 36 (Concedida)	NELPINAR SOCIEDAD ANÓNIMA	189
523616	29/08/2022	CHATEAU BRAVA PUNTA DEL ESTE	37 (Concedida) y 36 (Concedida)	NELPINAR SOCIEDAD ANÓNIMA	189
523617	29/08/2022	CHATEAU MANSO PUNTA DEL ESTE	37 (Concedida) y 36 (Concedida)	NELPINAR SOCIEDAD ANÓNIMA	189
523618	29/08/2022	MEDUSA	35 (Concedida)	KRYGIER, FLORENCIA	189
523619	29/08/2022	(figurativa)	5 (Concedida S/D)	NOVARTIS AG.	201
523620	29/08/2022	CONSTELACIÓN	25 (Concedida)	MARIA ROSA ZUNINO	
523621	29/08/2022	MS MC.SOUND (mixta)	12 (Concedida) y 9 (Concedida)	PALLA ARAMBERRY FERNANDO MARTIN	220
523622	29/08/2022	GUIA PUNTA	41 (Concedida), 35 (Concedida) y 16 (Concedida)	CAROLINA DE MARCO	
523623	29/08/2022	CLYTIA COLLEGE "DA LUZ A LO QUE AMAS" (mixta)	41 (Concedida) y 9 (Concedida)	VARELA CANO, SONIA MABEL	201
523624	29/08/2022	AKO SUPER ZINC (mixta)	1 (Concedida)	TILENUR S.A.	154
523625	29/08/2022	AKO FOSFITO PLUS MN-CU (mixta)	1 (Concedida)	TILENUR S.A.	154

N° Exp	Resolución	Marca	Clases	Titular	Ag.
523626	29/08/2022	AKO SULFA MAX (mixta)	1 (Concedida)	TILENUR S.A.	154
523628	29/08/2022	KEEP CONTROL (mixta)	1 (Concedida)	TILENUR S.A.	154
523631	29/08/2022	AKO POTASIO PLUS (mixta)	1 (Concedida)	TILENUR S.A.	154
523633	29/08/2022	AKO BORO (mixta)	1 (Concedida)	TILENUR S.A.	154
523636	29/08/2022	LOVE & HOME (mixta)	24 (Concedida)	TZIPORTEX S.A.S	220
523637	29/08/2022	PAPELARTE (mixta)	16 (Concedida)	EURIGAMAS S.R.L	
523638	29/08/2022	ATHENA FOODS (mixta)	40 (Concedida S/D)	MINERVA S.A.	94
523639	29/08/2022	ATHENA FOODS (mixta)	40 (Concedida S/D)	MINERVA S.A.	94
523640	29/08/2022	(figurativa)	5 (Concedida S/D)	AstraZeneca UK Limited	136
523641	29/08/2022	RADIOPLAY	38 (Concedida) y 35 (Concedida)	ALBERTO MARTIN SCASSO VOLONTE	
523681	29/08/2022	JACK BLACK	3 (Concedida S/D)	Jack Black, L.L.C.	194
523692	29/08/2022	LAS MIL Y UNA (mixta)	43 (Concedida)	Capurro Ferrao, Guillermo	245
523694	29/08/2022	PQUICK (mixta)	39 (Concedida) y 9 (Concedida)	PQUICKER SAS	144
523695	29/08/2022	TERN (mixta)	12 (Concedida S/D)	MOBILITY HOLDINGS LIMITED	201
523699	29/08/2022	PANOIL	1 (Concedida)	MOLINARI, LUCAS	201
523700	29/08/2022	TILMISHOT	5 (Concedida)	VIRBAC URUGUAY S.A.	201
523701	29/08/2022	ZURAFULL	5 (Concedida)	VIRBAC URUGUAY S.A.	201
523702	29/08/2022	FARMAGROUP	35 (Concedida)	Manuel Vidal y Ignacio Vidal	172
523703	29/08/2022	RHINO (mixta)	9 (Concedida S/D)	RHINO MAQUINARIA S.A. DE C.V.	212
523707	29/08/2022	FRESH BITES (mixta)	32 (Concedida) y 5 (Concedida)	GALLARDO PANTOJA, SANDRA TATIANA	189
523708	29/08/2022	BIO CONFORT (mixta)	37 (Concedida)	SARDEÑA BRAGA, TABARÉ RIVERA	189
523712	29/08/2022	STELLARIS	10 (Concedida S/D)	Bausch & Lomb Incorporated	212
523713	29/08/2022	STELLARIS ELITE	10 (Concedida S/D)	Bausch & Lomb Incorporated	212
523714	29/08/2022	RONAPREVE	5 (Concedida S/D)	F. HOFFMANN-LA ROCHE AG	201
523800	29/08/2022	EARTH'S SPLENDOR	5 (Concedida)	Tapestry Brands, Inc.	194
523804	29/08/2022	BIO BALANCE (mixta)	32 (Concedida)	Guillermo Eduardo RAED	220
523806	29/08/2022	CREATIVA (mixta)	41 (Concedida) y 35	MEDALLA RIVAS, EVA MARIA	201

N° Exp	Resolución	Marca	Clases	Titular	Ag.
			(Concedida)		
523817	30/08/2022	PLAYCARD	36 (Concedida) y 35 (Concedida)	ALBERTO MARTIN SCASSO VOLONTE	
523820	29/08/2022	GREINER BIO-ONE	20 (Concedida S/D), 10 (Concedida S/D) y 5 (Concedida S/D)	Greiner Bio-One GmbH	212
523821	29/08/2022	HYALOTEND	5 (Concedida S/D)	Fidia Farmaceutici S.p.A.	136
523823	29/08/2022	SWITCH	12 (Concedida S/D)	Switch Mobility Limited	136
523824	29/08/2022	LEKKER	43 (Concedida) y 30 (Concedida)	Nuritur S.A.	144
523825	29/08/2022	RENTAVIDA	36 (Concedida)	Santiago Antonini y Santiago Antonini	
523826	29/08/2022	CILOCALA (mixta)	25 (Concedida S/D) y 18 (Concedida S/D)	LIANCA & CO., LIMITED	144
523828	29/08/2022	TENKEY (mixta)	35 (Concedida S/D), 25 (Concedida S/D), 24 (Concedida S/D) y 18 (Concedida S/D)	ORGANIZACIÓN GOMEZ DE ZAMORA, S.L.	34
523831	30/08/2022	IPHONE FOR LIFE (mixta)	36 (Concedida) y 35 (Concedida)	APPLE INC.	245
523832	30/08/2022	BLAUER. UNCOMPROMISING PERFORMANCE (mixta)	25 (Concedida S/D), 18 (Concedida S/D) y 9 (Concedida S/D)	BLAUER WORLD FASHION S.r.l.	194
523833	29/08/2022	BLAUER (mixta)	25 (Concedida S/D), 18 (Concedida S/D) y 9 (Concedida S/D)	BLAUER WORLD FASHION S.r.l.	194
523835	29/08/2022	FRV (mixta)	42 (Concedida S/D), 40 (Concedida S/D), 39 (Concedida S/D), 37 (Concedida S/D),	Fotowatio Renewable Ventures, S.L.	245



N° Exp	Resolución	Marca	Clases	Titular	Ag.
			36 (Concedida S/D), 35 (Concedida S/D), 9 (Concedida S/D) y 7 (Concedida S/D)		
523837	30/08/2022	CHOCHA LA VACA VEGGIE BURGER (mixta)	29 (Concedida S/D)	Valeria Bouzigues	
523840	29/08/2022	R&S (mixta)	25 (Concedida)	SUAREZ CRISTINO FANNY ROSANA	220
523846	30/08/2022	TNT (mixta)	25 (Concedida)	BURINA SOCIEDAD ANÓNIMA	189
523848	30/08/2022	COCOMIEL	35 (Concedida)	BURINA SOCIEDAD ANÓNIMA	189
523849	30/08/2022	MATEA (mixta)	42 (Concedida), 41 (Concedida), 38 (Concedida), 35 (Concedida) y 9 (Concedida)	ASOCIACION CIVIL PROVIDENCIA	241
523850	30/08/2022	SECCO (mixta)	32 (Concedida)	ESTUDIO PORTO S.R.L.	220
523851	30/08/2022	B.M.T.	30 (Concedida S/D)	Subway IP LLC	144
523855	30/08/2022	CREDIPLAY	36 (Concedida) y 9 (Concedida)	ALBERTO MARTIN SCASSO VOLONTE	
523859	30/08/2022	MISS CAROL (mixta)	35 (Concedida) y 18 (Concedida)	ALEJANDRO CYNOWICZ; DIEGO BEJAR y DANIEL CYNOWICZ	220
523862	30/08/2022	MOTOMAX (mixta)	37 (Concedida S/D)	AUTECO MOBILITY S.A.S.	144
523863	30/08/2022	MOTOMAX (mixta)	35 (Concedida S/D)	AUTECO MOBILITY S.A.S.	144
523864	30/08/2022	AMVOX (mixta)	11 (Concedida) y 9 (Concedida)	REISTAR INDUSTRIA E COMERCIO DE ELETRONICOS LTDA.	144
523865	30/08/2022	DR. SELBY SI HIDRATA	3 (Concedida)	TERRY S.A.	144
523866	30/08/2022	GRAFIRAN	5 (Concedida S/D)	SYNGENTA CROP PROTECTION AG	194
523867	30/08/2022	DR. SELBY SYNDET PH 5,5	3 (Concedida)	TERRY S.A.	144
523870	30/08/2022	CETRANGOLO NEGOCIOS INMOBILIARIOS - ESCRIBANIA ESTUDIO CONTABLE (mixta)	36 (Concedida S/D)	CETRANGOLO ALTHALLER, JUAN MIGUEL	34
523880	30/08/2022	NALUA (mixta)	11 (Concedida) y 7	ACOCILLI SOCIEDAD ANONIMA	179

N° Exp	Resolución	Marca	Clases	Titular	Ag.
			(Concedida)		
523881	30/08/2022	EL DECANO CARLOS GOBERNA	41 (Concedida)	CARLOS GOBERNA	
523882	30/08/2022	ESENCIAL PLENITUD	5 (Concedida S/D)	Kimberly-Clark Worldwide, Inc.	201
523884	30/08/2022	LIKE (mixta)	28 (Concedida), 14 (Concedida), 12 (Concedida), 11 (Concedida), 10 (Concedida), 9 (Concedida) y 7 (Concedida)	DAFEROL S.A.	220
523888	30/08/2022	INGREAR	1 (Concedida)	ARCOR S.A.I.C.	154
523889	30/08/2022	(figurativa)	42 (Concedida), 41 (Concedida), 21 (Concedida), 17 (Concedida), 16 (Concedida) y 1 (Concedida)	International Biodegradable Products Institute, Inc.	136
523892	30/08/2022	PAPELARIA HOME (mixta)	35 (Concedida S/D)	ASTERIOL S.A.	201
523897	30/08/2022	F (mixta)	12 (Concedida S/D)	Bridgestone Licensing Services, Inc.	245
523906	30/08/2022	HOOFPRIINT	44 (Concedida S/D) y 5 (Concedida S/D)	Livestock Improvement Corporation Limited	144
523907	29/08/2022	FINE TOO (mixta)	25 (Concedida S/D)	Chugan Electronic Commerce Co., Ltd.	144
523909	29/08/2022	MERCEDES-EQ	12 (Concedida S/D)	Mercedes-Benz Group AG.	34
523910	29/08/2022	FLUTIPLÚS	5 (Concedida)	LABORATORIOS HAYMANN S.A.	144
523912	29/08/2022	(figurativa)	43 (Concedida S/D), 36 (Concedida S/D) y 35 (Concedida S/D)	Marriott Worldwide Corporation	194
523913	29/08/2022	THERMAPLUS OBLAK	19 (Concedida) y 6 (Concedida)	OBLAK HNOS. S.A.C.I.F. e I.	245
523916	29/08/2022	VOLVO PENTA	37 (Concedida S/D),	Volvo Trademark Holding AB	212

N° Exp	Resolución	Marca	Clases	Titular	Ag.
			12 (Concedida S/D) y 7 (Concedida S/D)		
523926	29/08/2022	OVER THE FALLS	25 (Concedida)	PONCE DE LEÓN, AGUSTÍN	189
523927	29/08/2022	INDULAB (mixta)	35 (Concedida)	INDULAB S.A.S.	189
523930	29/08/2022	EXPO INCLUSION ONLINE URUGUAY (mixta)	41 (Concedida)	AGENCIA DE COMUNICACIONES Y MARKETING BLANCO 360 LTDA.	201
523947	29/08/2022	FILTROMAX	40 (Concedida), 37 (Concedida), 35 (Concedida), 12 (Concedida) y 7 (Concedida)	Filtromax SAS	101
523948	29/08/2022	ALCANCE HOGAR GOLD (mixta)	45 (Concedida)	MARÍA INÉS GARCÍA ÁLVAREZ	192
523949	29/08/2022	ALCANCE HOGAR SILVER (mixta)	45 (Concedida)	MARÍA INÉS GARCÍA ÁLVAREZ	192
523950	30/08/2022	SIMBIPLÚS	5 (Concedida S/D)	LABORATORIOS HAYMANN S.A.	144
523952	29/08/2022	WOLF (mixta)	12 (Concedida S/D)	AUTECO MOBILITY S.A.S.	144
523953	29/08/2022	ALCANCE HOGAR GOLD PLUS.+ (mixta)	45 (Concedida)	MARÍA INÉS GARCÍA ÁLVAREZ	192
523954	30/08/2022	VOLTA MOTORBIKES (mixta)	12 (Concedida S/D)	AUTECO MOBILITY S.A.S.	144
523955	29/08/2022	ALCANCE INDIVIDUAL GOLD (mixta)	45 (Concedida)	MARÍA INÉS GARCÍA ÁLVAREZ	192
523957	30/08/2022	KI-CAB (mixta)	5 (Concedida S/D)	HK INNO. N CORPORATION	34
523958	29/08/2022	ALCANCE INDIVIDUAL SILVER (mixta)	45 (Concedida)	MARÍA INÉS GARCÍA ÁLVAREZ	192
523959	30/08/2022	MERCEDES-EQ	28 (Concedida S/D), 27 (Concedida S/D), 25 (Concedida S/D), 24 (Concedida S/D), 21 (Concedida S/D), 20 (Concedida S/D), 18 (Concedida S/D), 16 (Concedida S/D),	Mercedes-Benz Group AG.	34

N° Exp	Resolución	Marca	Clases	Titular	Ag.
			14 (Concedida S/D), 11 (Concedida S/D), 9 (Concedida S/D), 8 (Concedida S/D), 7 (Concedida S/D), 6 (Concedida S/D) y 3 (Concedida S/D)		
523960	30/08/2022	UV MUNE	3 (Concedida S/D) y 1 (Concedida S/D)	L'OREAL	144
523962	30/08/2022	CISER FIXPACK (mixta)	6 (Concedida S/D)	CIA. INDUSTRIAL H. CARLOS SCHNEIDER	194
523964	29/08/2022	(figurativa)	12 (Concedida S/D)	WM SMART MOBILITY (SHANGHAI) CO., LTD.	144
523966	30/08/2022	FF (mixta)	25 (Concedida S/D), 20 (Concedida S/D), 18 (Concedida S/D), 14 (Concedida S/D), 9 (Concedida S/D) y 3 (Concedida S/D)	Fendi s.r.l.	212
523968	29/08/2022	(figurativa)	25 (Concedida S/D) y 18 (Concedida S/D)	Fendi s.r.l.	212
523969	30/08/2022	FF (mixta)	14 (Concedida S/D) y 9 (Concedida S/D)	Fendi s.r.l.	212
523970	29/08/2022	(figurativa)	5 (Concedida S/D) y 3 (Concedida S/D)	The Procter & Gamble Company	212
523973	30/08/2022	EXPRESS TERMAL	39 (Concedida)	Gerardo Perdomo	
523974	30/08/2022	EXPO INCLUSIÓN	38 (Concedida S/D) y 35 (Concedida S/D)	Fernando Carotta Derudder	
523975	29/08/2022	JOYZZE (mixta)	11 (Concedida S/D) y 8 (Concedida S/D)	Wuhan Shernbao Pet Products Manufacturing Co., Ltd.	220

N° Exp	Resolución	Marca	Clases	Titular	Ag.
523976	30/08/2022	IL GIACO (mixta)	35 (Concedida) y 30 (Concedida)	GIACOMONI CAPORALE, FRANCESCO	189
523979	30/08/2022	PRIME (mixta)	39 (Concedida S/D), 36 (Concedida S/D), 35 (Concedida S/D) y 9 (Concedida S/D)	Amazon Technologies, Inc.	136
523982	30/08/2022	U (mixta)	35 (Concedida S/D)	Hard Rock Limited	242
523993	29/08/2022	KYLY (mixta)	25 (Concedida)	KYLY INDÚSTRIA TÊXTIL LTDA	34
523997	30/08/2022	D&K DENGKE (mixta)	34 (Concedida S/D)	Wenzhou Dengke Electronics Co., Ltd.	144
524200	30/08/2022	AEROPAC	39 (Concedida)	Jorge Walter Vitureira Bonilla y Mauro Rombys Barberia	105
524205	30/08/2022	PYRENEX (mixta)	25 (Concedida)	PYRENEX	179
524206	30/08/2022	MOVI-GO	5 (Concedida)	SPACHEM SUCURSAL URUGUAY, SRL	218
524217	30/08/2022	VALOUY	36 (Concedida) y 35 (Concedida)	WODTAX S.A. (en proceso de cambio de nombre a VALORES ADMINISTRADORA DE FONDOS DE INVERSIÓN Y FIDEICOMISOS S.A.)	94
524230	30/08/2022	STARLET (mixta)	35 (Concedida) y 25 (Concedida)	PRILI S.A.	245
524235	30/08/2022	LA CON K (mixta)	41 (Concedida)	SONDOR S.A.	34
524239	30/08/2022	MARLIN	12 (Concedida S/D)	TREK BICYCLE CORPORATION	194
524240	30/08/2022	FANTA	30 (Concedida S/D)	THE COCA-COLA COMPANY	94
524254	30/08/2022	LANHTROPY	25 (Concedida) y 24 (Concedida)	Rosario María Ponce de Leon Abella	
524262	30/08/2022	EUROBIKE	12 (Concedida)	MINBROL S.A.	189
524272	30/08/2022	SCOTIA GO	36 (Concedida) y 35 (Concedida)	THE BANK OF NOVA SCOTIA	94
524273	30/08/2022	SCOTIABANK GO	36 (Concedida) y 35 (Concedida)	THE BANK OF NOVA SCOTIA	94
524276	30/08/2022	GEMAR	28 (Concedida S/D)	GEMAR SRL	216
524286	30/08/2022	RIPIO	36 (Concedida S/D)	NETANY S.A.	94

N° Exp	Resolución	Marca	Clases	Titular	Ag.
			y 9 (Concedida S/D)		
524290	30/08/2022	VOZAMA	5 (Concedida)	ZODIAC INTERNATIONAL CORPORATION	245
524293	30/08/2022	(figurativa)	36 (Concedida S/D)	NETANY S.A.	94
524298	30/08/2022	RCN	36 (Concedida S/D)	NETANY S.A.	94
524402	30/08/2022	SPACE-DWELLER	14 (Concedida S/D)	ROLEX SA	144
524407	30/08/2022	MAXI COMPRAS SUPERMERCADOS (mixta)	35 (Concedida)	MAXICOMPRAS S.A.	201
524419	30/08/2022	BRAINTOYS (mixta)	28 (Concedida)	BRAIN TOYS SPA	201
524540	31/08/2022	KINGSTON FURY	9 (Concedida S/D)	KINGSTON TECHNOLOGY CORPORATION	34
524544	31/08/2022	VICTECHE (mixta)	8 (Concedida S/D) y 7 (Concedida S/D)	Ningbo Genin Industrial Co., Ltd.	34
524563	30/08/2022	CH CHORTI (mixta)	29 (Concedida S/D)	COOPERATIVA CHORTITZER LTDA.	201
524564	30/08/2022	CHORTI BEEF (mixta)	29 (Concedida S/D)	COOPERATIVA CHORTITZER LTDA.	201
524573	31/08/2022	EMPRENDETA (mixta)	38 (Concedida) y 35 (Concedida)	TATIANA LORENA COSTA PEREZ	
524575	31/08/2022	OCTOPUS (mixta)	25 (Concedida)	Mariana Prado Scotto	
524583	30/08/2022	DONDERRA	5 (Concedida S/D) y 1 (Concedida S/D)	SYNGENTA CROP PROTECTION AG	194
524592	30/08/2022	BIOTIKON	1 (Concedida S/D)	ALEXANDER MICHALZIK	34
524596	30/08/2022	MANUCHAR	1 (Concedida S/D)	MANUCHAR NV	144

### ***RESOLUCIONES DE FRASES PUBLICITARIAS, CONCEDIDAS***

N° Exp	Resolución	Marca	Clases	Titular	Ag.
500215	19/08/2022	VIVO PARA VOS	41 (Concedida) y 38 (Concedida)	MONTE CARLO T.V. S.A.	144
522043	08/08/2022	THE GREATEST NEVER SETTLE	32 (Concedida)	STOKELY-VAN CAMP, INC.	201
522047	08/08/2022	NEVER SETTLE ON YOUR PATH TO GREATNESS	32 (Concedida)	STOKELY-VAN CAMP, INC.	201
522048	08/08/2022	CAMINO A LA GRANDEZA	32 (Concedida)	STOKELY-VAN CAMP, INC.	201
522049	08/08/2022	NO TE DETENGAS	32 (Concedida)	STOKELY-VAN CAMP, INC.	201

N° Exp	Resolución	Marca	Clases	Titular	Ag.
522050	08/08/2022	NO TE CONFORMES	32 (Concedida)	STOKELY-VAN CAMP, INC.	201
522081	10/08/2022	PERFORMANCE EM TUDO	7 (Concedida S/D)	SOFAPE FABRICANTE DE FILTROS S.A.	34
522180	08/08/2022	SMARTLIFE ENCIENDE EMOCIONES (mixta)	11 (Concedida), 9 (Concedida) y 7 (Concedida)	VISUAR S.A.	34
522573	10/08/2022	TU BUSQUEDA TERMINA ACÁ	35 (Concedida)	DECOSOL S.A.	201
522577	10/08/2022	DE PRODUCTORES PARA PRODUCTORES	35 (Concedida)	COOPERATIVA AGRARIA NACIONAL DE RESPONSABILIDAD LIMITADA (COPAGRAN)	201
523050	30/08/2022	CLINKKY EL BANCO DE LOS NIÑOS	42 (Concedida) y 9 (Concedida)	CLINKKYLAB S.R.L.	34
523499	16/08/2022	CADA DÍA LA NATURALEZA EN TU PIEL	3 (Concedida)	Bionagrin Ltda.	101
523583	29/08/2022	ALCANCE AMAMOS CUIDARTE	45 (Concedida) y 44 (Concedida)	MARIA INES GARCÍA ÁLVAREZ	192
523967	29/08/2022	URUGUAY ADELGAZA	44 (Concedida)	ELBAUM, ALBERTO	245

### ***RESOLUCIONES DE MARCAS, DESESTIMADAS***

N° Exp	Resolución	Marca	Clases	Titular	Ag.
479314	22/08/2022	DEEP ACTION	3 (Denegada S/D)	Unilever Global IP Limited	136
487349	15/08/2022	COPPER CHEF (mixta)	21 (Concedida S/D) y 11 (Concedida S/D)	KE M.O. HOUSE CO., LTD.	220
489360	22/08/2022	JOE WHITE MALTINGS	31 (Denegada S/D)	Cargill Malt Asia Pacific Pty Ltd	201
491429	03/08/2022	FIT	29 (Denegada)	FRIGORIFICO CENTENARIO S.A.	179
494442	05/08/2022	ZAFIRO	14 (Denegada)	ALEJANDRO DANIEL BONICA NUDELMAN	
495826	12/08/2022	KITANA	41 (Denegada)	SIMOIS TELLERIA, NICOLAS	201
496510	03/08/2022	(tridimensional)	14 (Denegada S/D)	CARTIER INTERNATIONAL AG	165
497296	12/08/2022	DIGITAL ISOLATION	7 (Denegada S/D) y 6 (Denegada S/D)	Fisher Controls International LLC	194

N° Exp	Resolución	Marca	Clases	Titular	Ag.
498062	12/08/2022	GRAM	36 (Denegada S/D)	Lantah LLC	144
498698	03/08/2022	SUPER CREATINE	32 (Denegada S/D) y 5 (Denegada S/D)	JHO Intellectual Property Holdings, LLC	201
499069	12/08/2022	PRIMA QUALITTA	30 (Denegada S/D)	COOPERATIVA REGIONAL DE CAFEICULTORES EM GUAXUPÉ LTDA. - COOXUPÉ	194
500950	05/08/2022	SEXCITAR COMPANIES OF LOVE WWW.SEXCITAR.COM (mixta)	38 (Denegada) y 35 (Denegada)	TAISON SOCIEDAD ANONIMA	189
501206	26/08/2022	NABAN	25 (Denegada)	LIZI RUAN	234
502628	15/08/2022	FARMINA CHEF CAT (mixta)	31 (Denegada)	FARMINA PET FOODS BRASIL LTDA	212
503120	19/08/2022	LA QUERENCIA	43 (Denegada)	José María Figueroa Silveira	
503121	19/08/2022	CHACHA (mixta)	30 (Denegada)	MERFIX S.A.	144
503466	10/08/2022	POCKET COFFEE (mixta)	30 (Denegada S/D)	RICLAN S.A.	18
503592	12/08/2022	POLÍTICA	16 (Denegada)	Ana Melendez	220
503615	19/08/2022	SOCIETE	29 (Denegada S/D)	SOCIETE DES CAVES ET DES PRODUCTEURS REUNIS DE ROQUEFORT	181
503870	16/08/2022	BOOK OF INCA	28 (Denegada S/D) y 9 (Denegada S/D)	adp Gauselmann GmbH	179
504194	16/08/2022	DIRTY BLINDS	37 (Denegada)	Francis Andreu Ricci	212
504204	10/08/2022	TOMAR TAXI	39 (Denegada S/D)	Leonardo Arroyo Gonzalez	218
504208	19/08/2022	BCI SEAMOS DIFERENTES	36 (Denegada S/D)	BANCO DE CREDITO E INVERSIONES	201
504530	05/08/2022	EL CHARRUA (mixta)	33 (Denegada)	FOURMENT HNOS.LTDA.	219
504607	19/08/2022	PIZZAS FACTORY	43 (Denegada)	Johnny Walker	
504609	19/08/2022	SOLO EMPANADAS	43 (Denegada)	Johnny Walker	
504667	26/08/2022	CLOVIN CLEVER ATTACK (mixta)	3 (Denegada S/D)	CALILIS S.A.	18
505389	05/08/2022	EVITA´S	30 (Denegada S/D)	Bernardo Ferreira	
505801	05/08/2022	MUAYTHAI	41 (Denegada)	PEREIRA FERNÁNDEZ, MARCOS DENIS	201
505847	15/08/2022	DOLCE MARTINA	25 (Denegada S/D)	Lucia Gonzalez Aguirre Zabala	



**RESOLUCIONES DE MARCAS, DESESTIMADAS (Art. 92, D. 34/999)**

<b>N° Exp</b>	<b>Resolución</b>	<b>Marca</b>	<b>Clases</b>	<b>Titular</b>	<b>Ag.</b>
512169	16/08/2022	GOURMEAT BOUTIQUE DE CARNES (mixta)	35 (Denegada)	Felipe Albanell	172
518433	18/08/2022	DROGUERÍA SAYAGO	3 (Denegada S/D)	Marcela Nereida Vazquez Bevilacqua	
522358	19/08/2022	ACTITUD SHOES (mixta)	25 (Denegada)	VANESA VIERA	
523063	16/08/2022	AADVANTAGE (mixta)	39 (Denegada S/D) y 35 (Denegada S/D)	AMERICAN AIRLINES, INC.	136
523803	29/08/2022	NUTRI POINT	30 (Denegada) y 29 (Denegada)	Antonella Ocaso y Agustin Sintas Pagano	
523854	30/08/2022	NATUREZAS (mixta)	30 (Denegada S/D) y 29 (Denegada S/D)	Guillermo Cabrera	
524404	30/08/2022	T2PARKING (mixta)	9 (Denegada S/D)	Claudio Siebel	172

**RESOLUCIONES DE MARCAS, DESISTIDAS (Art. 90, D. 34/999)**

<b>N° Exp</b>	<b>Resolución</b>	<b>Marca</b>	<b>Clases</b>	<b>Titular</b>	<b>Ag.</b>
522085	09/08/2022	SECURITAS INNOVA (mixta)	45 (Pendiente), 37 (Pendiente) y 9 (Pendiente)	Securitas Sistemas SA	216
522306	08/08/2022	LOS POLLOS HERMANOS	43 (Desistida) y 35 (Desistida)	Daniela Reyes	
522309	08/08/2022	NOBRE	21 (Desistida) y 16 (Desistida)	ANA LAURA PANIZZA	
522356	29/08/2022	ACER (mixta)	35 (Desistida), 28 (Desistida), 20 (Desistida), 14 (Desistida) y 9 (Desistida)	Acer Incorporated	181

N° Exp	Resolución	Marca	Clases	Titular	Ag.
522538	10/08/2022	HAPPY NAPPERS	24 (Desistida S/D)	Leticia TOBAL FULLANA	
522912	16/08/2022	NICER DICER MAGIC CUBE	21 (Desistida) y 11 (Desistida)	INTERMARK LTDA.	201
522966	16/08/2022	VARENS BEAUTE (mixta)	3 (Desistida S/D)	ULRIC DE VARENS SA	144
523217	19/08/2022	VELVET (mixta)	35 (Desistida) y 25 (Desistida)	Virginia Gil	
523477	19/08/2022	CONTOUR	24 (Desistida)	INTERMARK LTDA.	201

### ***RESOLUCIONES DE MARCAS, DESISTIDAS (Art. 92, D. 34/999)***

N° Exp	Resolución	Marca	Clases	Titular	Ag.
504389	29/08/2022	RESURRECCIÓN	41 (Desistida S/D)	Anibal Alonso	
507950	29/08/2022	URUGUAY PUNTA WINES (mixta)	41 (Desistida) y 35 (Desistida)	Andrea Castillo	
509330	19/08/2022	ANNETTE NEGOCIOS INMOBILIARIOS (mixta)	42 (Desistida), 36 (Desistida) y 35 (Desistida)	SUSANA BEATRIZ ROULLIER LIMA	
516464	18/08/2022	CEBADAS CARDINAL (mixta)	31 (Desistida)	GREISING Y ELIZARZU S.R.L.	
516607	19/08/2022	MADERABLE	20 (Desistida S/D)	Juan Pablo Martinez	
516657	03/08/2022	KENTUCKY FUEGO DESDE 1942 (mixta)	43 (Desistida S/D) y 30 (Desistida S/D)	COMERIX S.A.	94
517169	19/08/2022	M2G SOLUCIONES (mixta)	9 (Desistida S/D)	M2G SOLUCIONES S.R.L.	
517365	19/08/2022	RESERVA DIRECTA (mixta)	42 (Desistida S/D), 39 (Desistida S/D) y 9 (Desistida S/D)	Interworlds S.A.	
517710	19/08/2022	PUNTO MATE	40 (Desistida S/D) y 18 (Desistida S/D)	viviana olivera	
517746	19/08/2022	URUGUAY MUSICAL	41 (Desistida S/D)	Francisco Varela	
517787	19/08/2022	RECETALIA RECETA DIGITAL (mixta)	38 (Desistida S/D) y 35 (Desistida S/D)	Daniel Carbajal y Adolfo Vacarezza	
517917	19/08/2022	SHOP BOT SHOP (mixta)	35 (Desistida S/D)	Enrique Javier Huerta Olivera y Martín Humberto	

N° Exp	Resolución	Marca	Clases	Titular	Ag.
				Furno Chaparro	
518022	19/08/2022	RICHMOND SOLUTION (mixta)	41 (Desistida S/D), 16 (Desistida S/D) y 9 (Desistida S/D)	Ediciones Santillana	172
518096	19/08/2022	BDM BIG DATA MACHINE (mixta)	9 (Desistida S/D)	Mara Geraldina Destefanis	
518350	30/08/2022	MOTAS UY PODER EN TU PELO (mixta)	1 (Desistida S/D)	MAIDANA PIRIZ TAMARA Y PIRIZ BOTTARO DORIS EVELYNI SOCIEDAD DE HECHO	
518391	30/08/2022	FANATICOS RADIO (mixta)	38 (Desistida S/D)	Andrés Caballero	
518494	05/08/2022	HAVANA GIRL (mixta)	25 (Desistida) y 3 (Desistida)	GHACHAM, HUSSEIN	201
518496	05/08/2022	G GINZA (mixta)	25 (Desistida)	GHACHAM, HUSSEIN	201
520025	16/08/2022	REFUGIO COLONIA (mixta)	43 (Desistida S/D)	ROSINA BALDI	
521839	19/08/2022	FISKER	12 (Desistida S/D)	DANIEL RICCA y GONZALO CABRERA	
521852	19/08/2022	SPORTFIT SALUD Y RENDIMIENTO (mixta)	41 (Desistida)	Santiago Sosa	172
521854	19/08/2022	SPORTFIT SALUD Y RENDIMIENTO (mixta)	41 (Desistida)	Santiago Sosa	172
521956	19/08/2022	QUESOS DON DIEGO	29 (Desistida S/D)	JUAN ANDRES PIAZZA	
522520	19/08/2022	OFERTASUY (mixta)	35 (Desistida)	Nicolás Ambrosi Regent	
522590	10/08/2022	RASTAFARI (mixta)	30 (Desistida S/D)	Martin Esteves	

### ***RESOLUCIONES DE FRASES PUBLICITARIAS, DESISTIDAS (Art. 92, D. 34/999)***

N° Exp	Resolución	Marca	Clases	Titular	Ag.
515157	19/08/2022	PRODUCTOS CONSCIENTES	35 (Desistida S/D)	Silvia Ayala	

### ***RESOLUCIONES DE RENOVACIONES, DESISTIDAS (Art. 92, D. 34/999)***

N° Exp	Resolución	Marca	Clases	Titular	Ag.
494761	19/08/2022	BRAVO 500	1 (Desistida)	PROQUIMUR SRL	172
501862	19/08/2022	BETTER LIFE	40 (Desistida) y 37	INVERSORA MADILEN S.A.	

N° Exp	Resolución	Marca	Clases	Titular	Ag.
			(Desistida)		

### ***RESOLUCIONES DE MARCAS, MODIFICADAS***

N° Exp	Resolución	Marca	Clases	Notas	Ag.
515284	22/08/2022	SUPERGYM / Ariel Najman / Alejandro Birnbaun	35 (Concedida)		167

### ***RESOLUCIONES DE MARCAS, ANULADAS***

N° Exp	Resolución	Marca	Clases	Notas	Ag.
416034	19/08/2022	PETRA	25 (Anulada S/D)	SANDRA VERONICA CANDELOT SOLECIO	

### ***RESOLUCIONES DE RENOVACIONES, MODIFICADAS***

N° Exp	Resolución	Marca	Clases	Notas	Ag.
483804	22/08/2022	OMEGA (mixta) / OMEGA SA (OMEGA AG) (OMEGA LTD.)	14 (Concedida S/D) y 9 (Concedida S/D)		201
510783	12/08/2022	VIA VALROSSA / TRES SAUCES S.A.	3 (Desistida)		144
518130	18/08/2022	RENTOKIL / Rentokil Initial 1927 Plc	5 (Concedida), 2 (Concedida) y 1 (Concedida)		218

### ***RESOLUCIONES DE RENOVACIONES, ANULADAS***

N° Exp	Resolución	Marca	Clases	Notas	Ag.
452982	09/08/2022	VIPER	41 (Anulada S/D), 37 (Anulada S/D), 28 (Anulada), 25 (Anulada), 18 (Anulada), 16 (Anulada), 14 (Anulada), 12 (Anulada)	FCA US LLC	187

N° Exp	Resolución	Marca	Clases	Notas	Ag.
			(Anulada), 11 (Anulada), 9 (Anulada S/D) y 7 (Anulada)		
524140	15/08/2022	NACHOS	30 (Anulada)	PAFRIMA LTDA.	129

### ***RESOLUCIONES DE RENOVACIONES, CONCEDIDAS***

N° Exp	Resolución	Denominación	Clases	Titular	Vigencia	Ag.
485724	17/08/2022	(figurativa)	1 (S/D), 2 (S/D), 3 (S/D), 5 (S/D), 6 (S/D), 8 (S/D), 10 (S/D), 11 (S/D), 13 (S/D), 14 (S/D), 16 (S/D), 17 (S/D), 18 (S/D), 19 (S/D), 20 (S/D), 21 (S/D), 22 (S/D), 23 (S/D), 24 (S/D), 25 (S/D), 26 (S/D), 27 (S/D), 29 (S/D), 30 (S/D), 31 (S/D), 32 (S/D), 33 (S/D), 34 (S/D), 35 (S/D), 36 (S/D), 37 (S/D), 38 (S/D), 39 (S/D), 40 (S/D), 41 (S/D), 42 (S/D), 43 (S/D), 44 (S/D) y 45 (S/D)	YAMAHA CORPORATION	28/09/2017	144
486281	18/08/2022	FROST	31	ALISUL ALIMENTOS S.A.	02/12/2017	18
486292	04/08/2022	CIGAR	3	PARFUMS PAROUR S.A.	04/08/2017	165
487285	18/08/2022	ENEPRA 1000 NOVO	5	QUIMFA INTERNATIONAL	21/12/2017	201

N° Exp	Resolución	Denominación	Clases	Titular	Vigencia	Ag.
				CORPORATION S.A.		
493711	19/08/2022	BIG DRUM (mixta)	7	Tetra Pak Processing Equipment GmbH	15/04/2018	34
495717	15/08/2022	EUGERIAL	5	GRAMÓN BAGÓ DE URUGUAY S.A.	15/06/2018	
498747	22/08/2022	BAX GLOBAL (mixta)	39 (S/D)	BAX GLOBAL INC.	17/09/2018	165
498751	22/08/2022	BAX GLOBAL (mixta)	36 (S/D)	BAX GLOBAL INC	17/09/2018	165
501792	19/08/2022	YFU	41 (S/D)	YFU International Educational Services Inc.	20/07/2019	136
509130	05/08/2022	GYPROC	6 (S/D)	SAINT-GOBAIN CONSTRUCTION PRODUCTS UK LIMITED	06/11/2019	165
509322	05/08/2022	DOVE(tridimensional)	3 (S/D)	Unilever Global IP Limited	29/02/2020	136
516834	16/08/2022	HEMPEL (mixta)	2	HEMPEL A/S	09/10/2020	144
517311	05/08/2022	ESTA BOCA ES MÍA (mixta)	38 y 41	SOCIEDAD TELEVISORA LARRAÑAGA S.A.	28/09/2020	241
517439	05/08/2022	CALVET	33 (S/D)	DULONG-CALVET SAS	01/11/2020	194
518449	18/08/2022	ORGANICS O (mixta)	3 (S/D)	Unilever Global IP Limited	24/01/2021	136
518545	19/08/2022	FRUTIGRAN	29 (S/D) y 31 (S/D)	ASOCIACION ARGENTINA DE LOS ADVENTISTAS DEL SÉPTIMO DÍA	01/11/2020	189
518801	05/08/2022	BRILLIOR	5 (S/D)	UPJOHN US 1 LLC	13/12/2020	144
518886	05/08/2022	FLUCO 150	5	BALIARDA S.A.	20/12/2020	201
519067	05/08/2022	IKATU (mixta)	9, 37, 38, 42 y 45	GLETIN S.A.	27/04/2021	165
519079	05/08/2022	SUCOFRESH	32	ABEMOL S.A.	20/01/2021	144
519395	05/08/2022	RIO NEGRO	6	RIO NEGRO COMERCIO E INDUSTRIA DE AÇO S.A.	30/11/2020	194
519398	22/08/2022	PENINSULA PUNTA DEL ESTE (mixta)	30	PINAKOL S.A.	30/11/2020	101
519426	05/08/2022	COLORIN AUTOPOLISH	3	COLORIN INDUSTRIA DE MATERIALES SINTETICOS S.A.	01/12/2020	179
519549	05/08/2022	JOSE CUERVO TRADICIONAL (mixta)	33 (S/D)	TEQUILA CUERVO, S.A. DE C.V.	13/12/2020	194
519593	22/08/2022	YALE	6 (S/D)	ASSA ABLOY AB	21/01/2021	144

N° Exp	Resolución	Denominación	Clases	Titular	Vigencia	Ag.
519626	05/08/2022	DURATOP	11 y 19	FERVA S.A.	08/03/2021	219
519648	22/08/2022	OMSA (mixta)	25 (S/D)	GOLDEN LADY COMPANY S.p.A.	06/12/2020	144
519674	22/08/2022	MAGIC (mixta)	25	WIZARDS OF THE COAST LLC	28/12/2020	212
519711	22/08/2022	NIOXIN	3	Wella International Operations Switzerland Sàrl	11/01/2021	201
519745	22/08/2022	EL PALACIO DEL CAFÉ (mixta)	30 (S/D)	EL PALACIO DEL CAFÉ S.A.	14/12/2020	189
519832	22/08/2022	PECARÍ CUEROS (mixta)	18 (S/D) y 25 (S/D)	PECARI CUEROS S.R.L.	21/12/2020	154
519859	22/08/2022	MODICON	37 y 41	SCHNEIDER ELECTRIC USA, INC	07/11/2020	194
519906	22/08/2022	ICAREY (mixta)	8 y 35	ICAREY S.A.	16/12/2020	194
519926	22/08/2022	TRADICION GAUCHA	30	JULIO CONO MANTERO COLMAN	17/12/2020	144
519927	22/08/2022	MIX & MATCH (mixta)	9	LG ELECTRONICS INC.	14/06/2021	144
519949	22/08/2022	MOLD-ZAP	31	ALLTECH INC.	20/12/2020	201
519982	02/08/2022	COSTA AZUL (mixta)	29 y 30	DA SILVA DA COSTA, JUAN CARLOS	21/02/2021	212
519985	02/08/2022	(figurativa)	39	ANA MONICA SCHMIDT GONZALEZ	01/03/2021	
520000	02/08/2022	CABALGATA	33	OSCAR JUAN KOROVAICHUK	20/12/2020	192
520001	02/08/2022	3-IN-1 (mixta)	2 (S/D), 3 (S/D) y 4 (S/D)	WD-40 COMPANY (DELAWARE)	12/06/2021	201
520002	02/08/2022	3-EN-UNO (mixta)	2 (S/D), 3 (S/D) y 4 (S/D)	WD-40 COMPANY (DELAWARE)	12/06/2021	201
520004	02/08/2022	ROSE (mixta)	33	MHCS	12/01/2021	201
520005	02/08/2022	WYNCA (mixta)	1 (S/D), 5 (S/D) y 17 (S/D)	ZHEJIANG XINAN CHEMICAL INDUSTRIAL GROUP CO., LTD.	03/06/2021	34
520006	02/08/2022	ALFA ROMEO (mixta)	12	Fiat Group Marketing & Corporate Communication SpA	27/08/2020	144
520007	02/08/2022	PIPETA FIPRO NIL LABYES FIPRO (mixta)	5	LABYES DE URUGUAY S.A.	30/12/2020	245
520008	02/08/2022	SELECCION DORADA	29 y 30	REGIONAL SUR S.A.	15/06/2021	245
520009	02/08/2022	REGIAFRUT	29 y 30	REGIONAL SUR S.A.	15/06/2021	245
520011	02/08/2022	GOLD SELECTION	29 y 30	REGIONAL SUR S.A.	15/06/2021	245
520012	02/08/2022	BARRON´S	16	DOW JONES & COMPANY INC.	15/06/2021	144

N° Exp	Resolución	Denominación	Clases	Titular	Vigencia	Ag.
520013	02/08/2022	VITAMINWATER XXX (mixta)	32 (S/D)	ENERGY BRANDS INC.	23/02/2021	94
520014	02/08/2022	RONSON	4	Sociedad Comercial e Importadora Enko Ltda.	17/01/2021	201
520016	02/08/2022	ACCU-CHEK	9 (S/D), 41 (S/D), 42 (S/D) y 44 (S/D)	ROCHE DIABETES CARE GmbH	18/01/2021	201
520018	02/08/2022	WORLD TRADE CENTER PUNTA DEL ESTE	35 (S/D)	WORLD TRADE CENTERS ASSOCIATION, INC.	23/01/2021	201
520019	02/08/2022	PANRETIN	5 (S/D)	Mercury Pharma Group Limited	06/07/2020	34
520033	02/08/2022	LA CHACRA	41 y 43	RAÚL MARIANO JUDE GURMENDEZ	28/12/2020	179
520039	22/08/2022	TÁ (mixta)	3	NEIRA MONTEMURRO, HÉCTOR	20/12/2020	189
520044	02/08/2022	M S N	42 (S/D)	Microsoft Corporation	04/01/2021	228
520045	02/08/2022	MEDIDERM	3, 30, 42 y 44	KANGSHENYUNGA S.A.	14/01/2021	136
520047	02/08/2022	COVIDIEN	1 (S/D), 3 (S/D), 5 (S/D), 9 (S/D), 10 (S/D), 16 (S/D), 25 (S/D), 41 (S/D) y 42 (S/D)	Covidien AG	18/01/2021	34
520048	02/08/2022	VIEJA PARCELA	33 (S/D)	RUMBO NATURAL S.A.	20/12/2020	212
520051	02/08/2022	XETIMOX	5 (S/D)	PROCAPS S.A.	07/12/2020	34
520052	02/08/2022	BIENEX	5 (S/D)	PROCAPS S.A.	07/12/2020	34
520053	02/08/2022	SEATTLE'S BEST COFFEE SMOOTH-ROASTED SINCE 1970 (mixta)	30 (S/D) y 43 (S/D)	SEATTLE'S BEST COFFEE LLC	28/02/2021	34
520056	02/08/2022	SATIN HANDS	3	MARY KAY INC.	30/01/2021	144
520057	02/08/2022	SOLÍS MEAT URUGUAY (mixta)	29 (S/D) y 35	ERSINAL S.A.	23/12/2020	94
520059	02/08/2022	NUESTRA MISIÓN ES ENRIQUECER LA VIDA DE LAS MUJERES	3 (S/D) y 16 (S/D)	MARY KAY INC.	22/02/2021	144
520063	02/08/2022	PLACACENTRO (mixta)	39	MASISA S.A.	17/01/2021	212
520067	02/08/2022	FRANJA BLANCA (mixta)	29 (S/D) y 30 (S/D)	BONAFIDE S.A.I.C.	21/01/2021	94
520074	02/08/2022	JOLIE	16	TILIBRA PRODUTOS DE PAPELARIA LTDA.	28/01/2021	194
520077	02/08/2022	GOGO'S CRAZY BONES (mixta)	28 (S/D)	PROMOÇÕES PREMIER DO BRASIL	24/05/2021	194



N° Exp	Resolución	Denominación	Clases	Titular	Vigencia	Ag.
				ALPHAVILLE LTDA		
520078	02/08/2022	FUMISPORE	1, 3 y 5	LCB FOOD SAFETY	25/03/2021	194
520104	02/08/2022	MADEFIBRA	19	DURATEX S.A.	28/12/2020	201
520110	02/08/2022	QUARTO DE MILLA	33	BLANDENGUES S.A.	20/12/2020	154
520113	02/08/2022	GALVUS MET (mixta)	5 (S/D)	NOVARTIS AG	21/06/2021	201
520114	03/08/2022	VOTRIENT	5 (S/D)	NOVARTIS AG.	21/06/2021	201
520122	03/08/2022	CONRAD	41	Hilton Worldwide Manage Limited	31/01/2021	194
520125	03/08/2022	CONRAD INTERNATIONAL	43 (S/D)	Hilton Worldwide Manage Limited	23/03/2021	194
520128	03/08/2022	ACONCAGUA	29	ACONCAGUA FOODS S.A.	28/12/2020	212
520129	03/08/2022	HARVARD BUSINESS REVIEW	16	PRESIDENT AND FELLOWS OF HARVARD COLLEGE	04/01/2021	194
520130	03/08/2022	CIU (mixta)	42	CAMARA DE INDUSTRIAS DEL URUGUAY	28/12/2020	245
520132	03/08/2022	LOPROFIN	5 (S/D)	N.V. NUTRICIA	23/02/2021	245
520133	03/08/2022	PLACACENTRO (mixta)	19	MASISA S.A.	17/01/2021	212
520135	03/08/2022	PLACACENTRO (mixta)	20	MASISA S.A.	17/01/2021	212
520136	03/08/2022	PLACACENTRO (mixta)	35	MASISA S.A.	17/01/2021	212
520137	03/08/2022	YANMAR	12 (S/D)	Yanmar Holdings Co., Ltd.	22/03/2021	156
520138	03/08/2022	SPRAYMATIC	5	TAZ LTDA.	27/04/2021	156
520141	03/08/2022	PLAYONLINE (mixta)	9 (S/D) y 41 (S/D)	KABUSHIKI KAISHA SQUARE ENIX (comerciendo también como Square Enix Co., Ltd.)	11/01/2021	194
520152	03/08/2022	FRIGORIFICO TACUAREMBO (mixta)	29	FRIGORIFICO TACUAREMBO S.A.	20/11/2020	201
520153	03/08/2022	BURGERBIF	29	FRIGORIFICO TACUAREMBO S.A.	16/01/2021	201
520164	03/08/2022	MONSTER	35 y 38	MONSTER WORLDWIDE, INC.	04/01/2021	194
520166	03/08/2022	CEROPLAGA (mixta)	5	SEMILLERIA DENUCIO LTDA.	17/01/2021	194
520169	03/08/2022	SURFBOARD	9	ARRIS TECHNOLOGY, Inc.	11/01/2021	194
520171	03/08/2022	COBERSTEEL	6	ARMCO URUGUAYA S.A.	23/03/2021	181
520177	03/08/2022	CONFORTPANEL	6	ARMCO URUGUAYA S.A.	23/03/2021	181

N° Exp	Resolución	Denominación	Clases	Titular	Vigencia	Ag.
520178	03/08/2022	MAXIPANEL	6	ARMCO URUGUAYA S.A.	23/03/2021	181
520180	03/08/2022	EL REGALO PERFECTO	35	SHOPPING CENTERS (URUGUAY) S.A.	30/05/2021	34
520183	03/08/2022	IVANOFF	33	DEMERARA DISTILLERS LIMITED	03/07/2020	34
520185	03/08/2022	GLADE SENSATIONS	5 (S/D)	S.C. JOHNSON & SON, INC.	23/06/2021	34
520190	03/08/2022	CELANESE	1 (S/D)	CELANESE INTERNATIONAL CORPORATION	21/01/2021	34
520194	03/08/2022	(figurativa)	30	CIA. INDUSTRIAL DE ALIMENTAÇÃO TRADING COMPANY	30/12/2020	34
520199	03/08/2022	AMIGO	21	SOLTIS S.A.	04/03/2021	201
520200	03/08/2022	(figurativa)	28	PLAYBOY ENTERPRISES INTERNATIONAL, INC.	11/01/2021	201
520201	03/08/2022	BSK (mixta)	3, 9, 14, 16, 18, 24, 25, 26, 28, 35 y 42	INDUSTRIA DE DISEÑO TEXTIL S.A. (INDITEX S.A.)	25/01/2021	201
520203	03/08/2022	BERSHKA	9, 14, 16, 26, 28, 35, 42, 43, 44 y 45	INDUSTRIA DE DISEÑO TEXTIL, S.A. (INDITEX, S.A.)	24/01/2021	201
520204	03/08/2022	COMFORTSTAR (mixta)	11, 35 y 37	E-AIR, LLC	17/01/2021	201
520205	03/08/2022	PULL & BEAR	35, 42, 43, 44 y 45	INDUSTRIA DE DISEÑO TEXTIL, S.A. (INDITEX, S.A.)	25/01/2021	201
520206	03/08/2022	DESSUTOL	2 y 17	PRODUCTOS VENIER S.A.	17/01/2021	201
520207	03/08/2022	VENIER MF	17	PRODUCTOS VENIER S.A.	17/01/2021	201
520208	22/08/2022	CIALIS	5 (S/D)	ELI LILLY AND COMPANY	25/01/2021	34
520209	03/08/2022	DEVA'S (mixta)	9 y 16	DEVA'S SOCIEDAD ANONIMA	29/12/2020	34
520214	03/08/2022	GUMIVIT C	5 (S/D)	PROCAPS S.A.	17/12/2020	34
520215	03/08/2022	ZITRIM	5 (S/D)	PROCAPS S.A.	16/12/2020	34
520217	03/08/2022	FACTIVE (mixta)	5 (S/D)	LG CHEM, LTD.	17/01/2021	194
520218	03/08/2022	TEXAS	34 (S/D)	COMPAÑIA INDUSTRIAL DE TABACOS MONTE-PAZ	21/01/2021	245
520219	03/08/2022	FINE LIGHTS (mixta)	34	COMPAÑIA INDUSTRIAL DE TABACOS MONTE-PAZ	04/01/2021	245
520220	03/08/2022	CORONADO	14 (S/D), 18 (S/D),	COMPAÑIA INDUSTRIAL DE	21/02/2021	245

N° Exp	Resolución	Denominación	Clases	Titular	Vigencia	Ag.
			24 (S/D), 25 (S/D), 27 (S/D), 28 (S/D), 31, 32 (S/D), 33 (S/D), 35, 41, 42, 43, 44 y 45	TABACOS MONTE-PAZ		
520221	04/08/2022	SF RECORD BOX SPECIAL LIGHTS FINEST FLAVOR SELECTED QUALITY TOBACCOS (mixta)	34 (S/D)	COMPAÑIA INDUSTRIAL DE TABACOS MONTE-PAZ	19/03/2021	245
520222	04/08/2022	MENTHOL NIAGARA S B (mixta)	34	COMPAÑIA INDUSTRIAL DE TABACOS MONTE-PAZ S.A.	01/03/2021	245
520223	04/08/2022	RICHMOND FILTER FINA SELECCIÓN DE TABACOS DE CALIDAD EXCEPCIONAL (mixta)	34	COMPAÑIA INDUSTRIAL DE TABACOS MONTE-PAZ S.A.	01/03/2021	245
520224	04/08/2022	CORONADO PLATA (mixta)	34	COMPAÑIA INDUSTRIAL DE TABACOS MONTE-PAZ S.A.	23/02/2021	245
520225	04/08/2022	CORONADO AUTENTICO (mixta)	34	COMPAÑIA INDUSTRIAL DE TABACOS MONTE-PAZ S.A.	22/02/2021	245
520226	04/08/2022	NEVADA AMERICAN BLEND (mixta)	34	COMPAÑIA INDUSTRIAL DE TABACOS MONTE-PAZ S.A.	22/02/2021	245
520228	04/08/2022	NEVADA FILTER AMERICAN BLEND (mixta)	34	COMPAÑIA INDUSTRIAL DE TABACOS MONTE-PAZ S.A.	01/03/2021	245
520229	04/08/2022	NEVADA FILTER AMERICAN BLEND (mixta)	34	COMPAÑIA INDUSTRIAL DE TABACOS MONTE-PAZ S.A.	22/02/2021	245
520230	04/08/2022	CORONADO AZUL (mixta)	34	COMPAÑIA INDUSTRIAL DE TABACOS MONTE-PAZ S.A.	21/02/2021	245
520231	04/08/2022	J & M (mixta)	34	COMPAÑIA INDUSTRIAL DE TABACOS MONTE-PAZ S.A.	22/02/2021	245
520241	04/08/2022	PRONDIL	5, 35, 42, 43, 44 y 45	PRONDIL S.A.	21/02/2021	192
520244	04/08/2022	NORTON	9 (S/D) y 45 (S/D)	NortonLifeLock Inc.	30/12/2020	192
520248	22/08/2022	HI FLY (mixta)	18 (S/D) y 25 (S/D)	Neldi Alicia Berriel	10/01/2021	

N° Exp	Resolución	Denominación	Clases	Titular	Vigencia	Ag.
520250	04/08/2022	W. WALKMAN (mixta)	9 (S/D)	SONY CORPORATION	25/01/2021	201
520251	04/08/2022	TECNORETE (mixta)	36	TECNORETE FRANCHISING S.R.L.	31/01/2021	201
520252	04/08/2022	CONTINEX BRANDT	5	BALIARDA S.A.	04/01/2021	201
520257	04/08/2022	FRUKI (mixta)	32	BEBIDAS FRUKI S/A	26/01/2021	163
520262	04/08/2022	TERRA BELLA (mixta)	29 y 30	BSF ADMINISTRAÇÃO LTDA.	07/01/2021	201
520263	04/08/2022	JUSSARA	29 (S/D) y 30 (S/D)	BSF ADMINISTRAÇÃO LTDA.	18/01/2021	201
520267	04/08/2022	TAG MUSIC (mixta)	9 (S/D)	LG ELECTRONICS INC.	29/06/2021	144
520270	22/08/2022	TAXI	3 (S/D)	COFINLUXE	30/12/2020	165
520271	04/08/2022	LA GERMINADORA	31	LA GERMINADORA S.A.I.C.F.E.I.	27/05/2021	218
520272	04/08/2022	OSKLEN (mixta)	25	TERRAS DE AVENTURA INDÚSTRIA DE ARTIGOS ESPORTIVOS S.A.	02/02/2021	34
520273	04/08/2022	POXIBONDER	1 y 16	SIDELA S.A.	31/01/2021	240
520275	04/08/2022	CIELO FM	38	Gustavo Vaneskahian	21/02/2021	
520276	04/08/2022	ARACELI GONZALEZ	9	ARACELI EDITH GONZALEZ	23/11/2020	212
520278	04/08/2022	ZOLPIC BRANDT	5	BALIARDA S.A.	04/01/2021	201
520279	04/08/2022	EASTON	35	Ernesto Easton	17/01/2021	218
520281	04/08/2022	NOVOMIX	5 (S/D)	Novo Nordisk A/S	23/03/2021	181
520282	04/08/2022	MILKFULS	30 (S/D)	August Storck KG	09/02/2021	240
520283	04/08/2022	NOVORAPID	5 (S/D)	Novo Nordisk A/S	23/03/2021	181
520294	04/08/2022	FUNDACION	31	EXPORTADORA UNIFRUTTI TRADERS SPA.	21/02/2021	220
520296	04/08/2022	CR-V	12 (S/D)	HONDA GIKEN KOGYO KABUSHIKI KAISHA (HONDA MOTOR CO., LTD.)	08/03/2021	94
520297	04/08/2022	LEGEND	12 (S/D)	HONDA MOTOR CO., LTD.	03/03/2021	94
520298	04/08/2022	(figurativa)	3 (S/D)	BEAUTE PRESTIGE INTERNATIONAL	02/01/2021	144
520300	04/08/2022	(figurativa)	3 (S/D)	BEAUTE PRESTIGE INTERNATIONAL	02/01/2021	144
520305	04/08/2022	LE CLUB PRIVÉE DE PUNTA DEL ESTE	43	MIGUEL ARMANDO SCHAPIRE	22/01/2021	245
520306	04/08/2022	SINTALC (mixta)	9 y 21	ZITAN S.A.	14/02/2021	104
520309	04/08/2022	VISIONI	24	GRUPO TEXSUR S.R.L.	17/01/2021	104

N° Exp	Resolución	Denominación	Clases	Titular	Vigencia	Ag.
520351	12/08/2022	ACRYLARM	5	Mega Labs S.A.	02/01/2021	144
520352	12/08/2022	BRIMOPRESS	5	Mega Labs S.A.	02/01/2021	144
520353	12/08/2022	BRINZOTEN	5	Mega Labs S.A.	02/01/2021	144
520356	12/08/2022	BRIXIA	5	Mega Labs S.A.	02/01/2021	144
520357	12/08/2022	DROPGEL	5	Mega Labs S.A.	02/01/2021	144
520358	12/08/2022	LOTESOFT	5 (S/D)	Mega Labs S.A.	02/01/2021	144
520359	12/08/2022	POENGLAUSIL	5	Mega Labs S.A.	02/01/2021	144
520360	12/08/2022	TOPTEAR	5	Mega Labs S.A.	02/01/2021	144
520361	12/08/2022	CLINOXDERM	5	Mega Labs S.A.	07/01/2021	144
520382	12/08/2022	LCS	10 (S/D)	DePuy Synthes, Inc.	16/02/2021	194
520471	18/08/2022	S SAPHIR BEAUTE DU CUIR (mixta)	3	AVEL (SOCIÉTÉ PAR ACTIONS SIMPLIFIÉE)	04/05/2021	144
520507	18/08/2022	AVITA CONCEPT	35	GRUPO PORCELAMIKA S.A.	13/01/2021	144
520532	16/08/2022	MANFRIG	37	ASQUETA CORBELLINI, JUAN JOSÉ y SCALONE MERNIS, EDUARDO DANIEL	23/03/2021	189
520580	01/08/2022	POWER A	3 (S/D)	L'OREAL	08/06/2021	144
520581	01/08/2022	STIMULISTE	3 (S/D)	L'OREAL	09/06/2021	144
520582	01/08/2022	L'OREAL (mixta)	3 (S/D) y 5 (S/D)	L'OREAL	12/06/2021	144
520583	01/08/2022	HYDRA GENESIS	3 (S/D)	L' OREAL	16/06/2021	144
520584	01/08/2022	LASTING DRAMA	3 (S/D)	L' OREAL	20/06/2021	144
520585	01/08/2022	IDOLE	3 (S/D)	L'OREAL	21/06/2021	144
520586	01/08/2022	AIR WEAR	3 (S/D)	L'OREAL	22/06/2021	144
520587	01/08/2022	HYPNOSE DRAMA	3 (S/D)	L'OREAL	27/06/2021	144
520588	01/08/2022	LASTING IMPACT	3 (S/D)	L' OREAL	30/06/2021	144
520589	01/08/2022	GLAMOUROUS	3 (S/D)	THE POLO/LAUREN COMPANY, L.P.	07/06/2021	144
520590	01/08/2022	ANAKIN SKYWALKER	28	LUCASFILM ENTERTAINMENT COMPANY LTD. LLC.	17/03/2021	144
520591	01/08/2022	DE TU LADO	38 y 41	MONTE CARLO T.V. S.A.	25/01/2021	144
520592	01/08/2022	TELEFLASH 4	41	MONTE CARLO T.V. S.A.	07/03/2021	144

N° Exp	Resolución	Denominación	Clases	Titular	Vigencia	Ag.
520593	01/08/2022	DE IGUAL A IGUAL	41	MONTE CARLO T.V. S.A.	07/03/2021	144
520594	01/08/2022	TIOVA SERVIMEDIC	5	SERVIMEDIC S.A.	28/03/2021	144
520595	01/08/2022	THYROID SERVIMEDIC	5	SERVIMEDIC S.A.	28/03/2021	144
520599	01/08/2022	(figurativa)	18 y 25 (S/D)	PONY INTERNATIONAL, LLC	25/02/2021	194
520603	01/08/2022	DOSTINEX	5 (S/D)	Pfizer Italia S.r.l.	28/02/2021	194
520606	19/08/2022	AVAYA (mixta)	9, 35, 37, 38 y 42	AVAYA INC.	29/03/2021	194
520607	02/08/2022	AVAYA	9, 35, 37, 38 y 42	AVAYA INC.	29/03/2021	194
520608	02/08/2022	LOGIPARK	39	LOGIPARK S.A.	04/01/2021	154
520614	02/08/2022	CRUZCAMPO (mixta)	32 (S/D)	HEINEKEN ESPAÑA, S.A.	18/04/2021	34
520615	02/08/2022	VERMAGEST	5	LABORATORIOS VIJOSA S.A. DE C.V.	12/06/2021	201
520616	02/08/2022	DOLO-DOCEPLEX	5	LABORATORIOS VIJOSA S.A. DE C.V.	11/07/2021	201
520618	02/08/2022	ACER (mixta)	9 (S/D), 35 (S/D) y 42 (S/D)	ACER INCORPORATED	01/03/2021	181
520619	02/08/2022	INTERPON	2 (S/D)	AKZO NOBEL COATINGS INTERNATIONAL B.V.	18/03/2021	34
520620	02/08/2022	INCALUX 2 EN 1 (mixta)	2	PINTURAS INCA S.A.	19/03/2021	34
520621	02/08/2022	ACER (mixta)	9 (S/D)	ACER INCORPORATED	19/05/2021	181
520622	02/08/2022	OSSCA (mixta)	12 (S/D)	OSSCA PARTS (CHINA) CO., LTD.	13/07/2021	34
520623	02/08/2022	SUPREME (mixta)	16 (S/D)	PPG INDUSTRIAL DO BRASIL - TINTAS E VERNIZES - LTDA	09/03/2021	144
520624	02/08/2022	CAFÉ HAG (mixta)	30 (S/D)	Jacobs Douwe Egberts DE GmbH.	21/01/2021	144
520626	02/08/2022	DELVERDE (mixta)	29 y 30	NEWLAT FOOD S.P.A.	14/01/2021	245
520627	02/08/2022	(figurativa)	2 (S/D)	AKZO NOBEL COATINGS INTERNATIONAL B.V.	21/01/2021	34
520632	02/08/2022	SCHOTT (mixta)	7 (S/D), 9 (S/D), 10 (S/D), 11 (S/D), 12 (S/D), 19 (S/D), 20 (S/D) y 21 (S/D)	SCHOTT AKTIENGESELLSCHAFT	21/02/2021	240
520633	02/08/2022	Q'BOA	3	INDUSTRIAS ANHEMBI S.A.	23/03/2021	144
520635	02/08/2022	MISSONI	25 (S/D)	MISSONI S.P.A.	14/01/2021	194

N° Exp	Resolución	Denominación	Clases	Titular	Vigencia	Ag.
520636	02/08/2022	TOTO (mixta)	6 (S/D), 20 (S/D) y 21 (S/D)	TOTO LTD.	07/06/2021	156
520637	02/08/2022	WASHLET (mixta)	11 (S/D)	TOTO LTD.	27/06/2021	156
520648	02/08/2022	JAGUAR (mixta)	8 (S/D), 11 (S/D) y 21 (S/D)	United Salon Technologies GmbH	04/04/2021	192
520652	02/08/2022	(figurativa)	5 (S/D) y 29 (S/D)	COMPAGNIE GERVAIS DANONE	28/02/2021	245
520654	02/08/2022	ACTIVIA (mixta)	29 (S/D)	COMPAGNIE GERVAIS DANONE	08/03/2021	245
520655	02/08/2022	DANATEN	5 (S/D), 29 (S/D) y 32 (S/D)	COMPAGNIE GERVAIS DANONE	23/03/2021	245
520656	02/08/2022	ACTIMEL	5 (S/D), 29 (S/D) y 32 (S/D)	COMPAGNIE GERVAIS DANONE	21/02/2021	245
520658	18/08/2022	NEO (mixta)	9	MAXIMILIANO GABRIEL MARCONI y R.BALAGUER S.A.	07/07/2021	34
520659	02/08/2022	IEDE INSTITUTE FOR EXECUTIVE DEVELOPMENT (mixta)	41 (S/D)	UNIVERSIDAD EUROPEA DE MADRID, S.A.U.	18/01/2021	34
520660	02/08/2022	TUPPERSEX	28 (S/D), 35 (S/D) y 41 (S/D)	DART INDUSTRIES INC.	24/05/2021	34
520661	02/08/2022	SAMSCA	5 (S/D)	OTSUKA PHARMACEUTICAL CO., LTD.	29/03/2021	34
520663	02/08/2022	S & C (mixta)	5	LA BUENA ESTRELLA S.A.	11/06/2021	34
520664	02/08/2022	FERMEX	30	COPALSA	21/02/2021	201
520666	02/08/2022	HARLEROS	39 y 41	H-D U.S.A., LLC	14/02/2021	201
520667	02/08/2022	FABULOSO PARAISO TROPICAL (mixta)	3	COLGATE-PALMOLIVE COMPANY	09/02/2021	201
520668	02/08/2022	BRASFIXO	7	BRASFIXO FIXOS DO BRASIL LTDA.	20/06/2021	34
520669	02/08/2022	PORTEX	5 (S/D)	SMITHS MEDICAL INTERNATIONAL LIMITED	25/02/2021	201
520671	02/08/2022	SOL (mixta)	3 (S/D)	COLGATE-PALMOLIVE COMPANY	26/02/2021	201
520673	02/08/2022	BOEHRINGER INGELHEIM (mixta)	5 (S/D), 10 (S/D) y 30 (S/D)	Boehringer Ingelheim Pharma GmbH & Co. KG	09/02/2021	201
520674	02/08/2022	SCN (mixta)	9	POLAKOF Y CIA S.A.	13/07/2021	94

N° Exp	Resolución	Denominación	Clases	Titular	Vigencia	Ag.
520675	03/08/2022	TADIVON	5	DROGUERIA INTI S.A.	09/02/2021	201
520678	03/08/2022	O'KY DRINK (mixta)	32	NOVAFOODS S.A	09/09/2020	144
520682	03/08/2022	MOTUL (mixta)	1 (S/D) y 4 (S/D)	MOTUL	16/05/2021	144
520683	03/08/2022	CASCO (mixta)	1 (S/D) y 16 (S/D)	HEXION INVESTMENTS INC.	21/01/2021	165
520684	03/08/2022	BUENVIVIR (mixta)	29	LENSOLE S.A.	18/01/2021	94
520685	03/08/2022	SPRINGFIELD (mixta)	35 (S/D)	TENDAM RETAIL S.A.	01/02/2021	216
520686	03/08/2022	ADVANTIS	9 (S/D)	REDSYS SERVICIOS DE PROCESAMIENTO, S.L.	19/03/2021	216
520687	03/08/2022	ADVANTIS	36 (S/D)	REDSYS SERVICIOS DE PROCESAMIENTO, S.L.	19/03/2021	216
520696	03/08/2022	FRUVI (mixta)	32	HACK LTD.	17/01/2021	34
520697	03/08/2022	ESTAFETA	38	ESTAFETA MEXICANA, S.A. DE C.V.	17/01/2021	181
520698	03/08/2022	ESTAFETA	39	ESTAFETA MEXICANA, S.A. DE C.V.	17/01/2021	181
520699	03/08/2022	FRIENDFINDER NETWORKS	42 y 45	Various, Inc.	16/05/2021	240
520702	03/08/2022	EXTAVIA (mixta)	5 (S/D)	NOVARTIS AG	13/07/2021	201
520704	03/08/2022	OCA (mixta)	39	ORGANIZACION COORDINADORA ARGENTINA S.R.L.	21/02/2021	201
520705	03/08/2022	AKG (mixta)	9 (S/D) y 10 (S/D)	AKG ACOUSTICS GMBH	27/12/2020	194
520706	03/08/2022	BOOKCEL	16	CELULOSA ARGENTINA S.A.	28/06/2021	201
520707	03/08/2022	SPRING C E L (mixta)	16	CELULOSA ARGENTINA S.A.	28/06/2021	201
520709	03/08/2022	VALLÉ EQUIPAMIENTOS ESPECIALES (mixta)	10, 12 y 35	R & O VALLE S.A.	04/05/2021	201
520710	03/08/2022	FLECKY	31	SAGEMULLER S.A.	22/02/2021	94
520711	03/08/2022	PC UTILITY (mixta)	9, 16, 35 y 42	SONDA URUGUAY S.A.	23/03/2021	94
520712	04/08/2022	DESMOPRESIN	5	FERRING BV	18/04/2021	181
520713	04/08/2022	NORPROLAC	5 (S/D)	FERRING B.V.	27/06/2021	181
520716	04/08/2022	IR (mixta)	1 (S/D), 4 (S/D), 6 (S/D), 7 (S/D), 8 (S/D), 9 (S/D), 11 (S/D), 12 (S/D), 16	Ingersoll-Rand Industrial U.S., Inc.	18/01/2021	194



N° Exp	Resolución	Denominación	Clases	Titular	Vigencia	Ag.
			(S/D), 19 (S/D), 20 (S/D), 25 (S/D), 37 (S/D), 41 (S/D) y 42 (S/D)			
520717	04/08/2022	IR	1 (S/D), 4 (S/D), 6 (S/D), 7 (S/D), 8 (S/D), 9 (S/D), 11 (S/D), 12 (S/D), 16 (S/D), 19 (S/D), 20 (S/D), 25 (S/D), 37 (S/D), 41 (S/D) y 42 (S/D)	Ingersoll-Rand Industrial U.S., Inc.	18/01/2021	194
520725	04/08/2022	MONTECON PUERTO DE MONTEVIDEO. NOS MUEVE URUGUAY. (mixta)	39	MONTECON S.A.	01/07/2021	34
520737	04/08/2022	WHOPPER	29 (S/D), 30 (S/D) y 31 (S/D)	BURGER KING CORPORATION	09/08/2020	136
520738	04/08/2022	BURGER KING	16 (S/D), 28 (S/D), 29 (S/D), 30 (S/D), 31 (S/D), 32 (S/D) y 33 (S/D)	BURGER KING CORPORATION	10/10/2020	136
520740	04/08/2022	GLADIATOR	9	MAXIMILIANO GABRIEL MARCONI y R.BALAGUER S.A.	13/04/2021	34
520741	04/08/2022	GRIESHABER MAXGRIP	10 (S/D)	Alcon Inc.	23/05/2021	34
520742	04/08/2022	FRESHLOOK	5	ALCON INC.	02/05/2021	34
520743	04/08/2022	HYALUBRIX	5 y 10	Fidia Farmaceutici S.p.A	25/01/2021	136
520745	04/08/2022	CRISTOBAL	3 (S/D)	BALENCIAGA	21/02/2021	194
520746	04/08/2022	NAVIGARE	14, 18 y 25	SASSON, FLORENCIA	12/06/2021	194
520747	04/08/2022	TEXACO (mixta)	37 (S/D)	CHEVRON INTELLECTUAL PROPERTY LLC	21/01/2021	144
520748	05/08/2022	AVITRIN	5 (S/D)	COVELI INDUSTRIA E COMERCIO	31/01/2021	144

N° Exp	Resolución	Denominación	Clases	Titular	Vigencia	Ag.
				LTDA.		
520749	05/08/2022	VALPEX	5 (S/D)	IVAX ARGENTINA S.A.	22/02/2021	227
520756	05/08/2022	Z (mixta)	7	Bosch Corporation	11/07/2021	156
520760	05/08/2022	EPIC (mixta)	23 (S/D)	J. & P. COATS, LIMITED	25/02/2021	245
520761	05/08/2022	WEBSTER´S (mixta)	16 (S/D)	MERRIAN-WEBSTER, INCORPORATED	21/01/2021	144
520767	05/08/2022	MOULINEX (mixta)	7, 9, 11 y 21	SEB S.A.	09/03/2021	34
520771	05/08/2022	ECP ESTRADIOL	5 (S/D)	KONIG URUGUAY S.A.	22/01/2021	129
520772	05/08/2022	GLOCAL CHEMICAL URUGUAY INVESTIGACION GLOBAL DESARROLLO LOCAL (mixta)	35	EDUARDO VAZQUEZ	14/02/2021	179
520773	05/08/2022	LA RENDIDORA	30 (S/D)	LENSOLE S.A.	25/01/2021	94
520774	05/08/2022	CRESTCOM	9, 16 y 41	CRESTCOM INTERNATIONAL, LLC	31/01/2021	94
520775	05/08/2022	BULLET PROOF	41	CRESTCOM INTERNATIONAL, LLC	31/01/2021	94
520776	05/08/2022	POWERADE (mixta)	32	THE COCA-COLA COMPANY	01/03/2021	94
520777	05/08/2022	CANADA DRY (mixta)	32 (S/D)	EUROPEAN REFRESHMENTS	22/03/2021	94
520778	05/08/2022	SNOW-FLAKE	30 (S/D)	Corn Products Development, Inc.	25/01/2021	216
520780	05/08/2022	CARTE BLANCHE	36	DINERS CLUB INTERNATIONAL LTD.	21/01/2021	194
520784	05/08/2022	ALAMEDA	33	Viña Fray Leon S.A.	08/02/2021	34
520786	05/08/2022	SHOPPING CHINA (mixta)	35 (S/D)	SOCIETAL S.A.	19/07/2021	201
520787	05/08/2022	CADUS (mixta)	33 (S/D)	MOLINOS RIO DE LA PLATA S.A.	11/07/2021	34
520789	05/08/2022	GOJO	3 (S/D), 5 (S/D) y 21 (S/D)	GOJO Industries, Inc.	06/06/2021	136
520790	05/08/2022	FRITOLIM	29 (S/D)	MOLINOS IP S.A.	08/07/2021	34
520791	05/08/2022	FORMULA 1	16	Formula One Licensing B.V.	11/06/2021	136
520794	05/08/2022	DOLOSEDOL	5	Gramón Bagó de Uruguay S.A.	25/01/2021	212
520802	05/08/2022	RICESOLO	5 (S/D)	RICECO LLC	01/02/2021	194
520803	05/08/2022	LANCER	1 y 5	UPL Limited	02/02/2021	194
520805	05/08/2022	DEDICADO.COM	38	ENALUR S.A.	05/02/2021	201
520807	05/08/2022	IMIDA GOLD	1 y 5	UPL Limited	08/02/2021	194

N° Exp	Resolución	Denominación	Clases	Titular	Vigencia	Ag.
520817	05/08/2022	ACEMIDA	1 y 5	UPL Limited	08/02/2021	194
520818	05/08/2022	SANITARIA PAYSANDU ES PODER CONSTRUIR BIEN	35	MOISES B. WULF S.R.L.	09/02/2021	129
520819	05/08/2022	MERCK	2, 3 y 9	MERCK KGaA	02/02/2021	129
520820	08/08/2022	SERONO (mixta)	5 (S/D), 9 (S/D), 10 (S/D) y 42 (S/D)	MERCK KGaA	02/02/2021	129
520821	08/08/2022	(figurativa)	1 (S/D), 2 (S/D), 3 (S/D), 4 (S/D), 5 (S/D), 6 (S/D), 7 (S/D), 8 (S/D), 9 (S/D), 10 (S/D), 11 (S/D), 12 (S/D), 13 (S/D), 14 (S/D), 15 (S/D), 16 (S/D), 17 (S/D), 18 (S/D), 19 (S/D), 20 (S/D), 21 (S/D), 22 (S/D), 23 (S/D), 24 (S/D), 25 (S/D), 26 (S/D), 27 (S/D), 28 (S/D), 29 (S/D), 30 (S/D), 31 (S/D), 32 (S/D), 33 (S/D), 34 (S/D), 35 (S/D), 36 (S/D), 37 (S/D), 38 (S/D), 39 (S/D), 40 (S/D), 41 (S/D), 42 (S/D), 43 (S/D), 44 (S/D) y 45 (S/D)	smart Automobile Co., Ltd.	23/03/2021	34
520823	08/08/2022	LA LEY URUGUAY (mixta)	9, 16, 35, 41 y 45	LA LEY SOCIEDAD ANONIMA EDITORIA E IMPRESORA	23/03/2021	34

N° Exp	Resolución	Denominación	Clases	Titular	Vigencia	Ag.
520824	08/08/2022	QUICK PHOS	1 y 5	UPL Limited	10/02/2021	194
520825	08/08/2022	THE CALLICRATE BANDER	10 (S/D)	NO-BULL ENTERPRISES LLC	10/06/2021	34
520826	08/08/2022	MANCOLAXYL 72 WP	1 y 5	UPL Limited	11/02/2021	194
520828	08/08/2022	CALLICRATE LOOPS	10 (S/D)	NO-BULL ENTERPRISES LLC	15/06/2021	34
520829	08/08/2022	SAATHI	1 y 5	UPL Limited	11/02/2021	194
520830	08/08/2022	WAVERLY	11 (S/D), 16 (S/D), 20 (S/D) y 21 (S/D)	Iconix Latin America LLC	09/02/2021	194
520831	08/08/2022	INTERCITY	43 (S/D)	ICH ADMINISTRAÇÃO DE HÓTEIS S.A.	24/02/2021	34
520832	08/08/2022	CYRUX 25 EC	1 y 5	UPL Limited	11/02/2021	194
520835	08/08/2022	SCAVOLINI	7 (S/D), 11 (S/D) y 20 (S/D)	SCAVOLINI S.P.A.	02/02/2021	194
520837	08/08/2022	CYRUX REPOSO	1 y 5	UPL Limited	16/02/2021	194
520838	08/08/2022	HERMAL	3 (S/D) y 5 (S/D)	ALMIRALL HERMAL GMBH	14/02/2021	194
520839	08/08/2022	ALMAX	5	ALMIRALL, S.A.	21/02/2021	194
520846	08/08/2022	APTAMIL	5 (S/D) y 29 (S/D)	NUTRICIA INTERNATIONAL B.V.	25/01/2021	245
520850	08/08/2022	LABYES	5	LABYES DE URUGUAY S.A.	09/02/2021	245
520851	08/08/2022	RUNNY'S (mixta)	29 y 30	NIZA S.A.	21/02/2021	212
520852	08/08/2022	RINALDI (mixta)	12	RINALDI S.A. INDUSTRIA DE PNEUMÁTICOS	26/01/2021	212
520858	08/08/2022	SENSACIONES (mixta)	30 (S/D)	BONAFIDE S.A.I.C.	23/02/2021	94
520865	08/08/2022	M (mixta)	9 (S/D) y 14 (S/D)	Movado Watch Company S.A.	22/02/2021	94
520869	09/08/2022	LA SERENISIMA LA VERDAD LACTEA (mixta)	29 (S/D)	MASTELLONE HNOS. S.A.	22/02/2021	245
520875	09/08/2022	ILLY	43	ILLYCAFFE S.P.A.	23/02/2021	201
520880	09/08/2022	LIDER	10	VILLA NUEVA S.A.	12/02/2021	220
520882	09/08/2022	SIKAGUARD	1, 2, 17 y 19	SIKA TECHNOLOGY AG.	21/02/2021	34
520884	09/08/2022	AUTOMOVIL CLUB DEL URUGUAY (mixta)	37 y 42	AUTOMOVIL CLUB DEL URUGUAY	18/04/2021	212
520894	09/08/2022	IONIL	5 (S/D)	LABORATOIRES BAILLEUL	24/10/2020	94

N° Exp	Resolución	Denominación	Clases	Titular	Vigencia	Ag.
				INTERNATIONAL SA.		
520901	09/08/2022	MONT BLANC (mixta)	2 y 19	COMPAÑIA ORIENTAL DE MINERALES S.A. (C.O.M.S.A.)	31/01/2021	
520906	09/08/2022	(figurativa)	10	AGA MEDICAL CORPORATION	29/03/2021	136
520907	09/08/2022	LABORATORIO CASTRO GHERARDI (mixta)	44 (S/D)	CAMPAR S.A.	31/05/2021	192
520909	09/08/2022	TIME	16 (S/D)	TIME USA, LLC	25/02/2021	34
520918	09/08/2022	AGROFRESH	1 (S/D)	AGROFRESH INC.	09/02/2021	194
520921	09/08/2022	JCB	7 (S/D), 12 (S/D) y 37 (S/D)	J.C. BAMFORD EXCAVATORS LTD.	10/03/2021	218
520924	09/08/2022	TRANQUERA (mixta)	25	ROMINUR S.A.	24/02/2021	218
520926	09/08/2022	TABAC ORIGINAL (mixta)	3	MÄURER & WIRTZ GMBH & CO. KG	10/02/2021	144
520929	09/08/2022	NUTRINOVA	1 (S/D), 5 (S/D) y 31 (S/D)	CELANESE SALES GERMANY GMBH	21/02/2021	34
520936	09/08/2022	VOLVO	37 (S/D)	VOLVO TRADEMARK HOLDING AB	08/03/2021	245
520938	09/08/2022	AKG (mixta)	9 (S/D) y 10 (S/D)	AKG ACOUSTICS GMBH	02/02/2021	194
520939	09/08/2022	SANISOFT	3 (S/D) y 5 (S/D)	ELECTROQUIMICA S.A.	21/02/2021	194
520940	09/08/2022	DALPONTE (mixta)	25 (S/D)	DALPONT MARK CORP.	28/01/2021	189
520941	09/08/2022	TICINO	3	ELECTROQUIMICA S.A.	10/05/2021	194
520942	09/08/2022	BRANY	3	ELECTROQUIMICA S.A.	10/05/2021	194
520951	09/08/2022	PRX	9 (S/D)	POWEREX, INC	17/02/2021	245
520952	09/08/2022	POWEREX	9 (S/D)	POWEREX, INC	17/02/2021	245
520960	09/08/2022	GLAM	25	MACROMEDIA S.A.	31/03/2021	220
520961	09/08/2022	MASTER (mixta)	34	ABAL HNOS. S.A.	20/04/2021	181
520966	09/08/2022	YPF	37	YPF SOCIEDAD ANONIMA	14/03/2021	34
520969	10/08/2022	KILLER 1000	5 (S/D)	EMPRESAS DEMARIA S.A.	21/02/2021	181
520972	10/08/2022	A.C.U. AUTOCLUB AUTOMÓVIL CLUB DEL URUGUAY (mixta)	16	AUTOMÓVIL CLUB DEL URUGUAY	21/07/2021	212
520974	10/08/2022	COMBINA (mixta)	2 y 35	JOSÉ ANDRÉS GUICHÓN	01/02/2021	201
520975	10/08/2022	DALPONTE (mixta)	28 (S/D)	DALPONT MARK CORP.	31/01/2021	189

N° Exp	Resolución	Denominación	Clases	Titular	Vigencia	Ag.
520976	10/08/2022	PINNACLE	28	ACUSHNET COMPANY	18/03/2021	212
520979	10/08/2022	TITLEIST	28	ACUSHNET COMPANY	18/03/2021	212
520980	10/08/2022	GORILA BY LRX (mixta)	25	INDUSTRIAS ARRAIJAN S.A.	01/02/2021	201
520981	10/08/2022	EL BUSCA- EN LA LUCHA DE LOS PRECIOS, TODOS SOMOS BUCAS	35	KYT S.A.	09/03/2021	212
520982	10/08/2022	EUROCHRONOS (mixta)	14 (S/D) y 35 (S/D)	EUROCHRONOS S.A.	01/02/2021	201
520984	10/08/2022	ARGIFAR	5	EUROFARMA URUGUAY S.A.	10/02/2021	201
520986	10/08/2022	HABICHUELAS CRECEMOS JUGANDO (mixta)	28	MANUELA MORALES y BETTINA ASARAVICIUS	15/04/2021	212
520994	10/08/2022	MOONSUN (mixta)	14 (S/D)	TM Brands, LLC	17/03/2021	212
520996	10/08/2022	PRESSINOX SISTEMA PRESSFITTING (mixta)	6	ALTIX S.A.	25/02/2021	218
520999	10/08/2022	AMERICAN SPORT BY TOTO AS BY TOTO (mixta)	18 y 25	SANARY S.A.	22/06/2021	212
521000	10/08/2022	IGENIX	5 (S/D)	EMPRESAS DEMARIA S.A.	03/02/2021	181
521001	10/08/2022	JAFRA	3 (S/D)	JAFRA MEXICO HOLDING COMPANY B.V.	18/04/2021	245
521002	10/08/2022	MYSTERIOUS (mixta)	3	TUPPERWARE PRODUCTS S.A.	29/06/2021	34
521003	10/08/2022	PARAJO	5	CLAUDIA BEATRIZ CALVI PRESTIGIACOMO	31/01/2021	101
521005	10/08/2022	CHALLENGER (mixta)	18 y 22	SILPEN LTDA.	12/07/2021	212
521016	10/08/2022	EFUDIX	5 (S/D)	Bausch + Lomb OPS B.V.	17/08/2020	192
521017	10/08/2022	MESTINON	5 (S/D)	Bausch + Lomb OPS B.V.	09/08/2020	192
521018	11/08/2022	PRESTO (mixta)	21 (S/D)	NATIONAL PRESTO INDUSTRIES, INC.	26/04/2021	192
521022	11/08/2022	DROGASIL (mixta)	5 (S/D) y 44 (S/D)	RAIA DROGASIL S.A.	09/02/2021	201
521023	11/08/2022	(figurativa)	25 (S/D) y 28 (S/D)	COMPAGNIE GÉNÉRALE DES ETABLISSEMENTS MICHELIN	16/02/2021	201
521024	11/08/2022	ZARA	9 (S/D) y 14 (S/D)	INDUSTRIA DE DISEÑO TEXTIL, S.A. (INDITEX S.A.)	22/02/2021	201
521030	11/08/2022	ACRYLITE	1 (S/D) y 17	Roehm America LLC.	16/03/2021	144

N° Exp	Resolución	Denominación	Clases	Titular	Vigencia	Ag.
521031	11/08/2022	DOBLO'	12 (S/D)	FIAT AUTO S.P.A.	22/02/2021	144
521032	11/08/2022	TALFLOX	5	Gramón Bagó de Uruguay S.A.	02/02/2021	181
521033	11/08/2022	HIMALAYAN	32	SEBASTIAN BALSAS	10/02/2021	144
521034	11/08/2022	GLIDDEN PROMASTER	2	PPG ARCHITECTURAL FINISHES, INC.	22/02/2021	144
521035	11/08/2022	PUNTOMIO	35 (S/D), 38 (S/D) y 39 (S/D)	SKYPOSTAL INC.	23/05/2021	144
521036	11/08/2022	TOONCAST (mixta)	38 y 41	THE CARTOON NETWORK, INC.	28/03/2021	144
521037	11/08/2022	GRISI (mixta)	5	GRISI HNOS., S.A. DE C.V.	22/02/2021	144
521038	11/08/2022	VIGILENSE	9 (S/D)	DICKEY-JOHN CORPORATION	02/02/2021	144
521039	11/08/2022	OPEL (mixta)	12 (S/D) y 37 (S/D)	OPEL AUTOMOBILE GmbH	19/03/2021	144
521043	11/08/2022	CERVEZA MODELO ESPECIAL (mixta)	32 (S/D)	CERVECERIA MODELO DE MEXICO S. de R.L. de C.V.	01/03/2021	144
521044	11/08/2022	SR SALDANHA RODRIGUES (mixta)	10	SALDANHA RODRIGUES LTDA.	22/06/2021	144
521045	11/08/2022	(figurativa)	9 (S/D)	COLISEE COMÉRCIO DE EQUIPAMENTOS ELETRÔNICOS LTDA.	10/02/2021	144
521046	11/08/2022	RUMBO	16, 35, 38, 39, 41, 42, 43 y 45	ANTONIO WALTER GALLICCHIO	20/07/2021	165
521048	11/08/2022	CILTYRI (mixta)	5 (S/D)	SANOFI	05/04/2021	165
521052	11/08/2022	AWAKEN 16-0-2 (mixta)	5	LOVELAND PRODUCTS, INC.	21/02/2021	220
521058	11/08/2022	KICKERS (mixta)	16, 18, 24 y 25	KICKERS INTERNATIONAL BV	22/02/2021	194
521062	11/08/2022	MAXAMAID	5 (S/D)	SHS International Ltd.	23/02/2021	245
521064	11/08/2022	GRIAL (mixta)	3	FASSON LTDA	02/02/2021	34
521065	11/08/2022	SKYTEAM (mixta)	39 (S/D)	GUARDANT, INC.	02/02/2021	194
521066	11/08/2022	SEARS	35 (S/D)	Transform SR Brands, LLC	02/02/2021	194
521068	11/08/2022	CASTRIP	6, 7 y 35	CASTRIP LLC	22/02/2021	34
521072	11/08/2022	MAXI DUCHA LORENZETTI (mixta)	11	LORENZETTI S/A INDÚSTRIAS BRASILEIRAS ELETROMETALÚRGICAS	01/03/2021	144

<b>N° Exp</b>	<b>Resolución</b>	<b>Denominación</b>	<b>Clases</b>	<b>Titular</b>	<b>Vigencia</b>	<b>Ag.</b>
521086	11/08/2022	AFP (mixta)	9 (S/D), 16 (S/D), 38 (S/D), 40 (S/D), 41 (S/D) y 42 (S/D)	AGENCE FRANCE-PRESSE	01/03/2021	179
521088	11/08/2022	IP (mixta)	25 (S/D)	DashAmerica, Inc.	04/02/2021	194
521090	11/08/2022	PEPSI (mixta)	32 (S/D)	PEPSICO, INC. UNA CORPORACIÓN DEL ESTADO DE CAROLINA DEL NORTE	23/02/2021	201
521093	11/08/2022	PEPSI (mixta)	32 (S/D)	PEPSICO, INC. UNA CORPORACIÓN DEL ESTADO DE CAROLINA DEL NORTE	24/02/2021	201
521094	11/08/2022	DIET PEPSI (mixta)	32 (S/D)	PEPSICO, INC. UNA CORPORACIÓN DEL ESTADO DE CAROLINA DEL NORTE	24/02/2021	201
521095	11/08/2022	PEPSI MAX (mixta)	32 (S/D)	PEPSICO, INC. UNA CORPORACIÓN DEL ESTADO DE CAROLINA DEL NORTE	24/02/2021	201
521097	11/08/2022	PEPSI (mixta)	32 (S/D)	PEPSICO, INC. UNA CORPORACIÓN DEL ESTADO DE CAROLINA DEL NORTE	24/02/2021	201
521098	12/08/2022	DIET PEPSI (mixta)	32 (S/D)	PEPSICO, INC. UNA CORPORACIÓN DEL ESTADO DE CAROLINA DEL NORTE	24/02/2021	201
521103	12/08/2022	MTN DEW	25 y 32 (S/D)	PEPSICO, INC. UNA CORPORACIÓN DEL ESTADO DE CAROLINA DEL NORTE	24/02/2021	201
521104	12/08/2022	(figurativa)	32 (S/D)	PEPSICO, INC. UNA CORPORACIÓN DEL ESTADO DE CAROLINA DEL NORTE	25/02/2021	201
521105	12/08/2022	(figurativa)	32 (S/D)	PEPSICO, INC. UNA CORPORACIÓN DEL ESTADO DE CAROLINA DEL NORTE	25/02/2021	201



N° Exp	Resolución	Denominación	Clases	Titular	Vigencia	Ag.
521108	12/08/2022	ACTY	7 (S/D), 12 (S/D) y 22 (S/D)	HONDA GIKEN KOGYO KABUSHIKI KAISHA	26/04/2021	94
521111	12/08/2022	CIVIC	12 (S/D)	HONDA GIKEN KOGYO KABUSHIKI KAISHA	26/04/2021	94
521112	12/08/2022	SKB	15 (S/D)	SKB CORPORATION	29/03/2021	194
521117	12/08/2022	TOTAL MAX (mixta)	31	NEOVIA NUTRIÇÃO E SAÚDE ANIMAL LTDA.	01/08/2021	34
521119	12/08/2022	TIME	9 (S/D)	TIME USA, LLC	25/02/2021	34
521122	12/08/2022	BIOVISC	5	SOPHIA HOLDINGS, S.A. DE C.V.	14/04/2021	34
521123	12/08/2022	SPLASH TEARS	5 (S/D)	SOPHIA HOLDINGS, S.A. DE C.V.	11/04/2021	34
521129	12/08/2022	FUELWATCH	12 (S/D), 37 (S/D) y 41 (S/D)	Volvo Truck Corporation	28/02/2021	194
521130	12/08/2022	BLACK DRESS	3	Avon Products, Inc.	31/01/2021	216
521131	12/08/2022	SECRET FANTASY	3 (S/D)	Avon Products, Inc.	13/07/2021	216
521132	12/08/2022	REVERSALIST	3	Avon Products, Inc.	08/04/2021	216
521135	12/08/2022	WINDSCAPE	3	Avon Products, Inc.	14/04/2021	216
521137	12/08/2022	SUPEREXTEND	3 (S/D)	Avon Products, Inc.	10/03/2021	216
521138	12/08/2022	SOKKIA	9 (S/D)	TOPCON CORPORATION	18/03/2021	216
521139	12/08/2022	IGNIS	12 (S/D)	SUZUKI MOTOR CORPORATION	19/03/2021	216
521140	12/08/2022	(figurativa)	9 (S/D) y 28 (S/D)	SONY INTERACTIVE ENTERTAINMENT INC	08/03/2021	216
521148	12/08/2022	INMOBILIARIA RIOS LTDA. (mixta)	36 (S/D)	INMOBILIARIA RIOS LTDA	10/06/2021	
521153	15/08/2022	LO BUENO POR MENOS (mixta)	16, 35 (S/D), 36 y 43	HENDERSON & CIA. S.A.	12/02/2021	181
521154	15/08/2022	CHISMOSA ECOLÓGICA TIENDA INGLESA LO BUENO POR MENOS (mixta)	16 y 18	HENDERSON & CIA. S.A.	14/02/2021	181
521155	15/08/2022	EL ANDALUZ (mixta)	30	HENDERSON & CIA. S.A.	17/02/2021	181
521156	15/08/2022	GARANTIA TIENDA INGLESA LO BUENO POR MENOS (mixta)	29, 30 y 31	HENDERSON & CIA. S.A.	28/02/2021	181
521160	15/08/2022	DESODIX	3	KANGSHENYUNGA S.A.	16/03/2021	136

N° Exp	Resolución	Denominación	Clases	Titular	Vigencia	Ag.
521161	15/08/2022	IMPETU GROUP	35, 38 y 41	DENA S.A.	09/02/2021	94
521162	15/08/2022	FEMICARE YAXIBELLE LAFRANCOL	5 y 33	Abbott Operations Uruguay S.R.L.	21/03/2021	136
521163	15/08/2022	D DUNHILL SINCE 1907 (mixta)	34 (S/D)	Dunhill Tobacco of London Limited	17/03/2021	194
521164	15/08/2022	MALEVO	5 (S/D)	SYNGENTA LIMITED	01/03/2021	194
521165	15/08/2022	PLAN PLANETA LIMPIO (mixta)	3 (S/D)	Unilever Global IP Limited	28/04/2021	136
521166	15/08/2022	FALCON	5 (S/D)	SYNGENTA LIMITED	22/03/2021	194
521167	15/08/2022	PIAGET (mixta)	25 y 28	RICHEMONT INTERNATIONAL S.A.	17/03/2021	194
521168	15/08/2022	ARKRAY	5 (S/D) y 10 (S/D)	ARKRAY, INC.	12/06/2021	136
521169	15/08/2022	PLEUR EVAC	10	Teleflex Medical Incorporated	18/03/2021	194
521170	15/08/2022	CANSON (mixta)	16 (S/D)	CANSON SOCIÉTÉ PAR ACTIONS SIMPLIFIÉE	29/03/2021	216
521182	15/08/2022	FITCO (mixta)	1	FITCO INTERNATIONAL S.A.	17/03/2021	144
521184	15/08/2022	SOL CARD SUPERSOL (mixta)	36 (S/D)	RADELCOR S.A.	17/03/2021	220
521185	15/08/2022	LANDI RENZO	7 (S/D) y 9 (S/D)	LANDI RENZO S.P.A.	23/02/2021	34
521186	15/08/2022	MVD STORE	35	GONZALO PENNINO	10/09/2020	
521196	15/08/2022	ORBASIL	17 (S/D)	SELENA IBERIA, S.L.U.	30/05/2021	245
521197	15/08/2022	QUILOSA	1 (S/D), 4 (S/D), 16 (S/D), 17 (S/D) y 19 (S/D)	SELENA IBERIA, S.L.U.	30/05/2021	245
521199	15/08/2022	TATÚ (mixta)	28 (S/D)	CASABO S.A.	25/02/2021	245
521202	15/08/2022	YOUTUBE	9, 35 y 42	Google LLC	01/03/2021	194
521204	15/08/2022	ESTRELLAS DINERS	36	DINERS CLUB INTERNATIONAL LTD.	08/03/2021	194
521206	15/08/2022	GLADE TOQUE	5 (S/D)	S. C. JOHNSON & SON, INC.	20/07/2021	34
521207	15/08/2022	HAVANA CLUB (mixta)	33	HAVANA CLUB HOLDING S.A.	12/06/2021	34
521210	15/08/2022	AKZONOBEL (mixta)	1 (S/D), 2 (S/D), 3 (S/D), 7 (S/D), 9 (S/D), 16 (S/D), 17 (S/D), 19 (S/D), 37 (S/D), 40 (S/D) y 42 (S/D)	AKZO NOBEL N.V.	08/04/2021	34

N° Exp	Resolución	Denominación	Clases	Titular	Vigencia	Ag.
521213	15/08/2022	ZANONI	29	AGRICULTORES FEDERADOS ARGENTINOS SOCIEDAD COOPERATIVA LIMITADA	09/02/2021	34
521216	15/08/2022	BODY GLOVE (mixta)	25	Body Glove IP Holdings LP, (U.S.Limited Partnership)	04/05/2021	201
521217	15/08/2022	LINEA VISIONE	9	VIVION S.A.	20/04/2021	165
521218	15/08/2022	ATELIER	9	CONATEL SA.	01/03/2021	165
521219	15/08/2022	LA PRAIRIE	44 (S/D)	LABORATOIRES LA PRAIRIE SA	02/03/2021	201
521220	15/08/2022	AQUAPORIN ACTIVE (mixta)	3 (S/D) y 5 (S/D)	BEIERSDORF AG	28/03/2021	201
521221	15/08/2022	TE QUIERE CON FUERZA LAVAGGI	30	ALICORP SOCIEDAD ANONIMA ABIERTA (ALICORP S.A.A.)	12/02/2021	212
521222	16/08/2022	NICOLINI CALOR DE HOGAR	30	ALICORP SOCIEDAD ANONIMA ABIERTA (ALICORP S.A.A.)	12/02/2021	212
521223	16/08/2022	LAVA CON POTENTE CARÑO BOLIVAR	3	ALICORP SOCIEDAD ANONIMA ABIERTA (ALICORP S.A.A.)	12/02/2021	212
521224	16/08/2022	ALACENA EL RICO SABOR DE CASA	29 (S/D) y 30 (S/D)	ALICORP SOCIEDAD ANONIMA ABIERTA (ALICORP S.A.A.)	12/02/2021	212
521227	16/08/2022	NIPRO (mixta)	10 (S/D)	NIPRO CORPORATION	11/06/2021	156
521229	16/08/2022	AISIN (mixta)	12	AISIN CORPORATION	08/03/2021	194
521231	16/08/2022	LUCKY BRAND	3, 14, 16, 18 y 35	ABG-LUCKY, LLC.	01/04/2021	201
521232	16/08/2022	SHALDAN	5	S.T. KABUSHIKI KAISHA ( S.T. CORPORATION)	08/03/2021	194
521234	16/08/2022	SP INTERVET (mixta)	5 (S/D) y 10 (S/D)	INTERVET INTERNATIONAL B.V.	17/03/2021	192
521237	16/08/2022	GLYCOLEOL	3 (S/D)	PIERRE FABRE DERMO-COSMETIQUE	23/03/2021	192
521241	16/08/2022	ZABALA (mixta)	29 (S/D) y 30 (S/D)	SILVINA BRIL BACHRACHAS	18/10/2020	105
521246	16/08/2022	BROUWER	5	Brouwer S.A.	04/03/2021	94
521250	16/08/2022	PAYSANDU MASSEILOT HNOS (mixta)	18 (S/D)	MASSEILOT HNOS. S.A.	09/08/2020	245
521251	16/08/2022	IDYLLE	3 (S/D)	GUERLAIN	09/02/2021	245
521258	16/08/2022	ESPECTADOR.COM	38	LANOS S.A.	09/03/2021	194

N° Exp	Resolución	Denominación	Clases	Titular	Vigencia	Ag.
521259	16/08/2022	MULITA	6	ARMCO URUGUAYA S.A.	19/03/2021	194
521261	16/08/2022	DA VINCI	10 (S/D)	Intuitive Surgical Operations, Inc.	02/08/2021	245
521267	16/08/2022	DECERO REMOLINOS VINEYARD	33	PERMASUR S.A.	29/04/2021	34
521268	16/08/2022	THE WORLD OF INTERIORS	16	The Conde Nast Publications Ltd.	09/02/2021	136
521270	16/08/2022	VIVERO PAOLA GARDEN CARMELO (mixta)	31 y 44	VIVERO PAOLA GARDEN S.R.L.	29/03/2021	201
521273	16/08/2022	WOMEN'S SECRET (mixta)	25 (S/D)	TENDAM RETAIL S.A.	09/03/2021	216
521275	16/08/2022	INVESTIS	36	COMPASS GROUP CHILE ASESORIAS E INVERSIONES S.A.	14/02/2021	201
521277	16/08/2022	COMPASS	36	COMPASS GROUP CHILE ASESORIAS E INVERSIONES S.A.	14/02/2021	201
521279	16/08/2022	ATLANTICO SUR	33 (S/D)	ESTABLECIMIENTO JUANICO S.A.	21/02/2021	201
521287	16/08/2022	PIVOT POINT	9, 16 y 41	PIVOT POINT INTERNATIONAL, INC.	29/08/2020	245
521288	16/08/2022	VITA-MIX	7	VITA-MIX MANAGEMENT CORPORATION	10/08/2020	94
521292	16/08/2022	FIBERTEL (mixta)	41	CABLEVISIÓN S.A.	13/08/2020	186
521293	16/08/2022	FIBERTV	38 y 41	CABLEVISIÓN S.A.	13/08/2020	186
521294	16/08/2022	FIBERFON	38 y 41	CABLEVISIÓN S.A.	13/08/2020	186
521295	16/08/2022	FIBERCORP	38 y 41	CABLEVISIÓN S.A.	13/08/2020	186
521296	16/08/2022	FIBERFAN	38 y 41	CABLEVISIÓN S.A.	13/08/2020	186
521297	16/08/2022	FIBERFUTBOL	38 y 41	CABLEVISIÓN S.A.	13/08/2020	186
521298	17/08/2022	FAIBER	38 y 41	CABLEVISIÓN S.A.	13/08/2020	186
521299	17/08/2022	FIBERKIDS	38 y 41	CABLEVISIÓN S.A.	13/08/2020	186
521300	17/08/2022	WIFIBER	38 y 41	CABLEVISIÓN S.A.	13/08/2020	186
521301	17/08/2022	ORIGINAL MAUSER (mixta)	13 (S/D)	Rheinmetall Waffe Munition GmbH	28/06/2021	219
521305	17/08/2022	ESSO DIESEL OIL AGRO	4 (S/D)	EXXON MOBIL CORPORATION	05/04/2021	136
521306	17/08/2022	ZAPALLO CONT. NETO 50G. 5 SOBRES DE 10G. (mixta)	29 (S/D)	KNORR-NÄHRMITTEL AKTIENGESELLSCHAFT	20/05/2021	136
521311	17/08/2022	M B UNIFORMES	25 (S/D)	Marianna Bekker	02/08/2023	
521312	17/08/2022	TYENNE	5 (S/D)	FRESENIUS KABI DEUTSCHLAND	29/03/2021	34

N° Exp	Resolución	Denominación	Clases	Titular	Vigencia	Ag.
				GmbH		
521313	17/08/2022	OBSERVA (mixta)	35 y 38	MICROCOSMOS S.A.	22/02/2021	218
521314	17/08/2022	MARATÓN DE PUNTA DEL ESTE (mixta)	41	CARLOS ALBERTO MARTINATTO JORGE; ALAIN ROBERT MIZRAHI BRUNSTEIN y ROBERTO JUAN BARRETO DA ROSA	11/02/2021	94
521315	17/08/2022	TACSA (mixta)	17	TECNOLOGIA ARGENTINA EN CINTAS S.A. (T.A.C.S.A.)	08/03/2021	94
521316	17/08/2022	CRİK CRACK	30	EL TRIGAL S.A.	20/02/2021	165
521317	17/08/2022	EL TRIGAL KRACKLES	30	EL TRIGAL S.A.	24/02/2021	165
521318	17/08/2022	ZOO-DESFILE	30	DISGAL S.A.	28/02/2021	165
521320	17/08/2022	CHOISE	29 (S/D), 30 (S/D) y 31 (S/D)	DISGAL S.A.	22/03/2021	165
521321	18/08/2022	BUNGE PRÓ (mixta)	29 (S/D)	BUNGE ALIMENTOS S/A	31/03/2021	245
521322	18/08/2022	PARK-LANE	29 (S/D), 30 (S/D) y 31 (S/D)	DISGAL S.A.	22/03/2021	165
521323	18/08/2022	TRIGALIA	29 y 30	EL TRIGAL S.A.	28/03/2021	165
521324	18/08/2022	GRANDIOSAS	29 y 30	DISGAL S.A.	31/03/2021	165
521325	17/08/2022	TRANSCARGO	39	WALTER GARGIULO y RODOLFO FACCINI	10/02/2021	245
521326	18/08/2022	CRAK CRACK	30	EL TRIGAL S.A.	02/04/2021	165
521327	18/08/2022	PANNINA (mixta)	30	DISGAL S.A.	05/04/2021	165
521328	18/08/2022	KETTAL CHIP	30	DISGAL S.A.	18/04/2021	165
521329	18/08/2022	DOUBLE GOLDEN LINE DGL (mixta)	30	DISGAL S.A.	31/03/2021	165
521330	18/08/2022	MEDLEY	5	MEDLEY INDUSTRIA FARMACEUTICA LTDA	21/02/2021	165
521331	18/08/2022	NIKKISO (mixta)	10 (S/D)	NIKKISO CO., LTD.	17/02/2021	201
521334	19/08/2022	PAN-STIK (mixta)	3 (S/D)	NOXELL CORPORATION	25/02/2021	201
521336	19/08/2022	(tridimensional)	30	CORPORATIVO INTERNACIONAL MEXICANO, S. DE R.L. DE C.V.	01/03/2021	201
521338	19/08/2022	HAVAL (mixta)	12 (S/D)	GREAT WALL MOTOR COMPANY	10/08/2021	34

N° Exp	Resolución	Denominación	Clases	Titular	Vigencia	Ag.
				LIMITED		
521339	19/08/2022	MEGAFLEX (mixta)	1 y 19	MEGAFLEX S.A.	21/02/2021	34
521343	19/08/2022	AVOMETIN	5 (S/D)	KONIG URUGUAY S.A.	21/02/2021	129
521344	19/08/2022	REVIVON	5	KONIG URUGUAY S.A.	21/02/2021	129
521345	19/08/2022	REINA ANA	35 y 37	KESTLIR S.A.	22/02/2021	129
521346	22/08/2022	GARAGE	35	RUBINO DOPAZO, ANDRÉS	14/02/2021	189
521348	22/08/2022	CHOCO POPS	30 (S/D)	KELLOGG COMPANY	23/02/2021	194
521349	22/08/2022	ONBRIZE	5 (S/D)	NOVARTIS AG	10/08/2021	201
521351	22/08/2022	KRONA	17 (S/D)	KRONA TUBOS E CONEXÕES S.A.	23/03/2021	194
521352	22/08/2022	OCASSION	3	HOUSE OF FULLER, S. DE R.L. DE C.V.	12/06/2021	34
521354	22/08/2022	VW (mixta)	36 (S/D)	VOLKSWAGEN AKTIENGESELLSCHAFT	19/03/2021	34
521355	22/08/2022	VOLKSWAGEN	36 (S/D)	VOLKSWAGEN AKTIENGESELLSCHAFT	19/03/2021	34
521356	22/08/2022	SMOFLIPID	5 (S/D)	FRESENIUS KABI AG	05/04/2021	34
521357	22/08/2022	EDGEPLUS	10 (S/D)	Alcon Inc.	01/06/2021	34
521358	22/08/2022	STAEDTLER (mixta)	16 (S/D)	STAEDTLER Mars GmbH & Co. KG	20/11/2020	136
521361	22/08/2022	KLARICID UD	5 (S/D)	ABBOTT LABORATORIES	29/03/2021	136
521363	22/08/2022	TRIBAL DDB	35 (S/D)	OMNICOM INTERNATIONAL HOLDINGS INC.	05/04/2021	194
521365	22/08/2022	SUPERMALT	32	FNC SOCIEDAD ANÓNIMA	31/03/2021	144
521366	22/08/2022	GRAN CHOPP CERVEZA PATRICIA SALUS (mixta)	32 (S/D)	FNC SOCIEDAD ANONIMA	05/04/2021	144
521367	22/08/2022	CERVEZA NEGRA SALUS PATRICIA (mixta)	32 (S/D)	FNC SOCIEDAD ANONIMA	05/04/2021	144
521371	22/08/2022	(figurativa)	12	JIANGLING MOTORS CO., LTD.	09/08/2021	34
521380	22/08/2022	COBOS (mixta)	33	VIÑA COBOS S.A.	21/02/2021	34
521781	09/08/2022	TARTARUGA PUNTA COLORADA - URUGUAY (mixta)	25 y 43	BARBERO LÓPEZ, JUAN LUIS	01/03/2021	189

N° Exp	Resolución	Denominación	Clases	Titular	Vigencia	Ag.
521783	09/08/2022	DC DIAGNOSTICAR (mixta)	37	Andrés Sebastián Furest Suárez	01/04/2021	
521785	09/08/2022	MERCADOSHOPS (mixta)	35 y 42	MercadoLibre Inc.	24/03/2021	94
521786	09/08/2022	EPIDUO	5 (S/D)	Galderma Skin Health S.A.	22/03/2021	245
521787	09/08/2022	CASTROL (mixta)	4 y 37	CASTROL LIMITED	29/03/2021	245
521788	09/08/2022	CRB	4 (S/D)	CASTROL LIMITED	01/09/2021	245
521789	09/08/2022	(figurativa)	1 (S/D), 4 (S/D), 9 (S/D), 37 (S/D), 39 (S/D), 42 (S/D) y 43 (S/D)	BP P.L.C.	09/05/2021	245
521790	09/08/2022	CITY (mixta)	12 (S/D)	HONDA MOTOR CO., LTD.	05/05/2021	94
521791	09/08/2022	MODDU (mixta)	16 y 35	MARPOLO S.A.	08/03/2021	245
521792	09/08/2022	METROGEL	5 (S/D)	Galderma Skin Health S.A.	12/06/2021	245
521793	09/08/2022	ORACEA	5 (S/D)	Galderma Skin Health S.A.	16/06/2021	245
521794	09/08/2022	AVIXIS	5 (S/D)	Galderma Holding S.A.	19/03/2021	245
521796	09/08/2022	HANOMAG	12	DHM INDUSTRIA S.A.	02/03/2021	192
521798	09/08/2022	LEVITON	9 (S/D) y 11 (S/D)	LEVITON MANUFACTURING CO., INC.	03/03/2021	192
521800	09/08/2022	WEG (mixta)	9	WEG S.A.	07/06/2021	144
521801	09/08/2022	MICOTIL	5 (S/D)	ELANCO US INC.	24/05/2021	192
521803	09/08/2022	ARSENALNOYE	32	BALTIKA BREWERIES	12/04/2021	34
521808	09/08/2022	ROSE CARDIN	3 (S/D)	PCM HOLDINGS, INC.	07/03/2021	192
521809	09/08/2022	GUARATINGUETA	23	CIA. FIACAO E TECIDOS GUARATINGUETA	23/03/2021	144
521811	09/08/2022	APCEHAHOE (mixta)	32	BALTIKA BREWERIES	12/04/2021	34
521813	09/08/2022	ZVL (mixta)	7 (S/D)	ZVL SLOVAKIA, A.S.	03/08/2021	34
521815	09/08/2022	FIMETA (mixta)	11	TERATEX S.A.	02/03/2021	94
521816	09/08/2022	VANTAGE	12 (S/D)	PIRELLI TYRE S.P.A.	01/03/2021	192
521817	09/08/2022	SINALUX (mixta)	9 (S/D)	ERTECNA - EMPRESA DE REVESTIMIENTOS TÉCNICOS, LDA	09/03/2021	144
521818	09/08/2022	EVERLUX (mixta)	9 (S/D)	ERTECNA - EMPRESA DE REVESTIMIENTOS TÉCNICOS, LDA	09/03/2021	144

N° Exp	Resolución	Denominación	Clases	Titular	Vigencia	Ag.
521819	09/08/2022	CRISAL (mixta)	21	Crisa Libbey Mexico, S. de R.L. de C.V.	26/04/2021	34
521823	09/08/2022	SELECTO ® (mixta)	33 (S/D)	ALADA IP SRL	03/03/2021	194
521828	09/08/2022	DOWEL	12	DHM INDUSTRIA S.A.	02/03/2021	192
521830	09/08/2022	LA AURORA (mixta)	29 y 35	ZAMBRANO ZERBINO, ALEJANDRO GERARDO	10/03/2021	201
521835	09/08/2022	BIO-GIDE	10 (S/D)	Ed. Geistlich Söhne AG Für Chemische Industrie	15/04/2021	136
521836	09/08/2022	BIO-OSS COLLAGEN	10 (S/D)	Ed. Geistliche Söhne AG Für Chemische Industrie	15/04/2021	136
521837	09/08/2022	BIO-OSS	10 (S/D)	Ed. Geistlich Söhne AG Für Chemische Industrie	15/04/2021	136
521840	09/08/2022	DOVE	3 (S/D)	Unilever Global IP Limited	31/05/2021	136
521843	09/08/2022	TAFFMAN-E	32	KABUSHIKI KAISHA YAKULT HONSHA	29/03/2021	201
521846	09/08/2022	PICTET	36 (S/D)	Banque Pictet & Cie SA	29/03/2021	201
521850	09/08/2022	ABSORBEX	5	SAGRIN S.A.	18/03/2021	189
521857	09/08/2022	LUISSI (mixta)	35	LUISSI S.A.	01/03/2021	194
521860	09/08/2022	OUROFINO AGRONEGÓCIO (mixta)	5 (S/D)	OURO FINO SAÚDE ANIMAL LTDA.	16/03/2021	144
521861	09/08/2022	OUROFINO AGRONEGÓCIO (mixta)	5 (S/D)	OURO FINO SAUDE ANIMAL LTDA.	17/03/2021	144
521862	09/08/2022	OUROFINO SAÚDE ANIMAL (mixta)	5 (S/D)	OURO FINO SAUDE ANIMAL LTDA.	17/03/2021	144
521863	10/08/2022	OUROFINO SAÚDE ANIMAL (mixta)	5 (S/D)	OURO FINO SAUDE ANIMAL LTDA.	17/03/2021	144
521865	10/08/2022	OUROFINO ANIMAL HEALTH (mixta)	5 (S/D)	OURO FINO SAUDE ANIMAL LTDA.	17/03/2021	144
521872	10/08/2022	KOWA (mixta)	5	KOWA COMPANY, LTD.	24/05/2021	201
521873	10/08/2022	STRADIVARIUS (mixta)	3, 9, 14, 16, 18, 25, 26, 35 y 42	STRADIVARIUS ESPAÑA, S.A.	23/03/2021	201
521876	10/08/2022	ADD CLEANER PETROBRAS (mixta)	4 (S/D)	PETROLEO BRASILEIRO S.A. - PETROBRAS	03/03/2021	94
521878	10/08/2022	STR (mixta)	3, 9, 14, 16, 18, 25 y 26	STRADIVARIUS ESPAÑA, S.A.	23/03/2021	201
521879	10/08/2022	ZAHIR	35	Alice Facal	04/03/2021	101



N° Exp	Resolución	Denominación	Clases	Titular	Vigencia	Ag.
521880	10/08/2022	F FENDI (mixta)	34	FENDI S.R.L.	04/03/2021	34
521885	10/08/2022	CAVENDISH & HARVEY	5 (S/D) y 30 (S/D)	Industrie-und Handelsunion Dr. Wolfgang Boettger GmbH & Co KG	16/06/2021	245
521887	10/08/2022	OSRAM	9, 10 y 11	OSRAM GmbH	15/03/2021	34
521890	10/08/2022	ETIOS	12 (S/D)	TOYOTA JIDOSHA KABUSHIKI KAISHA (ALSO TRADING AS TOYOTA MOTOR CORPORATION)	17/08/2021	144
521891	10/08/2022	TACOMA	12 (S/D)	TOYOTA JIDOSHA KABUSHIKI KAISHA (ALSO TRADING AS TOYOTA MOTOR CORPORATION)	17/08/2021	144
521893	10/08/2022	(figurativa)	1 (S/D), 5 (S/D), 31 (S/D), 42 y 44	BASF SE	03/05/2021	144
521894	10/08/2022	LISTERINE TOTAL CARE	5 (S/D)	JOHNSON & JOHNSON	14/03/2021	194
521895	10/08/2022	IRGAPHOR	2 (S/D)	BASF SE	16/04/2021	144
521896	10/08/2022	OPERA	5 (S/D)	BASF SE	03/05/2021	144
521897	10/08/2022	LURAZOL	2 (S/D)	BASF SE	31/05/2021	144
521899	10/08/2022	HEAT	5 (S/D)	BASF SE	03/05/2021	144
521900	10/08/2022	KIXOR	1 (S/D)	BASF SE	04/04/2021	144
521902	10/08/2022	LISTERINE CUIDADO TOTAL	5 (S/D)	JOHNSON & JOHNSON	15/03/2021	194
521905	10/08/2022	ZAMPRO	5 (S/D)	BASF SE	30/06/2021	144
521907	10/08/2022	LISTERINE TOTAL CARE	3 (S/D)	JOHNSON & JOHNSON	11/04/2021	194
521910	10/08/2022	VELCADE (mixta)	5 (S/D)	Millennium Pharmaceuticals, Inc.	01/03/2021	136
521911	10/08/2022	CITADEL	36 (S/D)	CE TM Holdings LLC	22/03/2021	194
521912	10/08/2022	CICLO LEGNANO (mixta)	12 (S/D)	EMILIO BOZZI S.R.L.	22/03/2021	194
521924	10/08/2022	OMRON	9 (S/D) y 16 (S/D)	OMRON CORPORATION	31/05/2021	212
521926	10/08/2022	OMRON	9 (S/D)	OMRON CORPORATION	31/05/2021	212
521927	10/08/2022	OMRON	9 (S/D) y 10 (S/D)	OMRON CORPORATION	31/05/2021	212
521928	10/08/2022	ACJ (mixta)	16, 25, 28, 35, 41, 43 y 45	ASOCIACION CRISTIANA DE JOVENES DE MONTEVIDEO	04/03/2021	201
521935	10/08/2022	WYCAMEN	5 (S/D)	GlaxoSmithKline Biologicals S.A.	12/04/2021	216

N° Exp	Resolución	Denominación	Clases	Titular	Vigencia	Ag.
521936	10/08/2022	EXPERT (mixta)	35 (S/D)	EXPERT INTERNATIONAL GMBH	19/07/2021	216
521938	10/08/2022	PM PRODUCTOS DE MAIZ S.A. (mixta)	1 (S/D), 5 (S/D) y 30 (S/D)	Corn Products Development, Inc.	25/05/2021	216
521948	10/08/2022	DON DAVID	33	GRUPO PEÑAFLORES S.A.	04/03/2021	94
521949	10/08/2022	PAJARITO	2 y 35	NESTOR EDUARDO WULF SARGANAS	05/04/2021	129
521950	10/08/2022	ARHO	35	DIBARIL S.A.	20/04/2021	129
521952	10/08/2022	LIBRAMPI	5	LABORATORIO LIBRA S.A.	25/04/2021	129
521953	10/08/2022	LIBRACTAM	5	LABORATORIO LIBRA S.A.	25/04/2021	129
521955	10/08/2022	AZO	6, 7, 9 y 19	AZO Holding GmbH	05/04/2021	144
521957	10/08/2022	CRIZAL	9 (S/D)	ESSILOR INTERNATIONAL	24/05/2021	144
521958	10/08/2022	DYNEEMA	9 (S/D), 12 (S/D) y 17 (S/D)	DSM IP ASSETS B.V.	01/04/2021	201
521959	10/08/2022	(figurativa)	3, 18 y 25	NAUTICA APPAREL, INC.	05/04/2021	201
521960	10/08/2022	LINGONG	7 (S/D), 12 (S/D), 35 (S/D) y 37 (S/D)	SHANDONG LINGONG CONSTRUCTION MACHINERY CO. LTD.	16/03/2021	194
521961	10/08/2022	CARNE ANGUS DEL URUGUAY (mixta)	29 (S/D)	SOCIEDAD DE CRIADORES DE ABERDEEN ANGUS DEL URUGUAY	17/03/2021	181
521962	10/08/2022	EMOTION	12	RENAULT S.A.S.	01/04/2021	201
521963	10/08/2022	(figurativa)	3, 14, 18, 25 y 35 (S/D)	Abercrombie & Fitch Europe Sagl	10/05/2021	205
521964	10/08/2022	SAND'UP	12	RENAULT S.A.S.	01/04/2021	201
521965	11/08/2022	EXTREME	12	RENAULT S.A.S.	04/04/2021	201
521967	11/08/2022	RR RUBI RUBI (mixta)	35	ADRIAN PEDRO BEKER	11/03/2021	220
521968	11/08/2022	DUSTER	12	RENAULT S.A.S.	08/04/2021	201
521969	11/08/2022	RR RUBI RUBI (mixta)	14	ADRIAN PEDRO BEKER	11/03/2021	220
521971	11/08/2022	(figurativa)	3, 14, 18 y 35 (S/D)	Abercrombie & Fitch Europe Sagl	04/04/2021	205
521973	11/08/2022	PRIVILEGE	12	RENAULT S.A.S.	16/04/2021	201
521974	11/08/2022	E SOUND (mixta)	9	HENDERSON & CIA. S.A.	16/03/2021	181

N° Exp	Resolución	Denominación	Clases	Titular	Vigencia	Ag.
521998	11/08/2022	CON TODO A PRECIO	35 y 43	TA -TA S.A.	04/04/2021	245
521999	11/08/2022	EXTREME QUALITY PAPERS (mixta)	16 (S/D) y 18	TA -TA S.A.	04/05/2021	245
522001	11/08/2022	FRUITTELLA	30 (S/D)	PERFETTI VAN MELLE BENELUX B.V.	21/08/2021	245
522003	11/08/2022	TA TA TE SIRVE	35 y 43	TA -TA S.A.	31/03/2021	245
522017	11/08/2022	SEMIKRON	16 (S/D) y 35 (S/D)	SEMIKRON INTERNATIONAL GMBH	08/06/2021	219
522018	11/08/2022	SEMIKRON (mixta)	16 (S/D) y 35 (S/D)	SEMIKRON INTERNATIONAL GMBH	08/06/2021	219
522019	11/08/2022	PLUSBELLE	3	ALICORP HOLDCO ESPAÑA, S.L.	06/03/2021	212
522026	11/08/2022	HEXVIX	5 (S/D) y 10 (S/D)	PHOTOCURE ASA	18/01/2021	34
522029	11/08/2022	S SCOTIABANK (mixta)	36	THE BANK OF NOVA SCOTIA	19/03/2021	94
522030	11/08/2022	S SCOTIABANK (mixta)	36	THE BANK OF NOVA SCOTIA	19/03/2021	94
522031	11/08/2022	GIANNI VERSACE (mixta)	18 (S/D)	GIANNI VERSACE S.R.L.	18/04/2021	212
522040	11/08/2022	BRILLIANCE	12 y 35	REMOL S.A.	18/08/2021	165
522045	11/08/2022	FISHER SCIENTIFIC	1 (S/D)	FISHER SCIENTIFIC COMPANY L.L.C.	09/08/2021	144
522053	11/08/2022	TN TODO NOTICIAS (mixta)	38 (S/D)	ARTE RADIOTELEVISIVO ARGENTINO S.A.	15/06/2021	205
522061	11/08/2022	ENGLISHTOWN.COM	9, 16, 35, 41 y 42	English One AG	09/03/2021	201
522062	11/08/2022	LANCASTER	3 (S/D)	COTY BEAUTY GERMANY GMBH	01/03/2021	201
522064	11/08/2022	BYD (mixta)	12 (S/D)	BYD COMPANY LIMITED	15/03/2021	201
522066	11/08/2022	ROLAC DE PETRILAC	2	QUIMICA DEL NORTE S.A.	11/03/2021	144
522067	11/08/2022	GATORADE G (mixta)	32 (S/D)	STOKELY-VAN CAMP, INC.	16/03/2021	201
522068	11/08/2022	FIERCE	32	STOKELY-VAN CAMP, INC.	23/03/2021	201
522070	11/08/2022	TROPICANA	29	TROPICANA PRODUCTS, INC.	17/03/2021	201
522071	11/08/2022	GAMESA PAN CREMA	30 (S/D)	CORPORATIVO INTERNACIONAL MEXICANO, S. DE R.L. DE C.V.	19/03/2021	201
522072	11/08/2022	QUE NUNCA FALTE	29 (S/D) y 30	PEPSICO, INC.	31/03/2021	201
522096	11/08/2022	NSA NUESTRA SEÑORA DE LA ASUNCION TRANSPORTE DE PASAJEROS Y CARGAS (mixta)	39 (S/D)	NUESTRA SEÑORA DE LA ASUNCION COMERCIAL E INDUSTRIAL S.A.	09/03/2021	201
522099	11/08/2022	MOTORMAN	25	POLCANY S.A.	28/03/2021	94

N° Exp	Resolución	Denominación	Clases	Titular	Vigencia	Ag.
522101	11/08/2022	DEDICADO	38	ENALUR S.A.	19/03/2021	201
522103	11/08/2022	MONTEPAZ	29 y 30	COMPAÑIA INDUSTRIAL DE TABACOS MONTE-PAZ	18/04/2021	245
522104	11/08/2022	VIVIR SANO (mixta)	41, 44 y 45	CRAME IAMPP	09/03/2021	101
522106	11/08/2022	RICHMOND	1 y 5	COMPAÑIA INDUSTRIAL DE TABACOS MONTE-PAZ	27/05/2021	245
522107	11/08/2022	J & M (mixta)	34	COMPAÑIA INDUSTRIAL DE TABACOS MONTE-PAZ	27/05/2021	245
522108	11/08/2022	AURA (mixta)	34	COMPAÑIA INDUSTRIAL DE TABACOS MONTE-PAZ	01/06/2021	245
522114	11/08/2022	(figurativa)	1 (S/D), 3 (S/D), 4 (S/D), 6 (S/D), 7 (S/D), 8 (S/D), 9 (S/D), 11 (S/D), 12 (S/D), 14 (S/D), 16 (S/D), 18 (S/D), 25 (S/D), 28 (S/D), 29 (S/D), 30 (S/D), 32 (S/D), 34 (S/D), 35 (S/D), 36 (S/D), 37 (S/D), 38, 41, 42 (S/D) y 43 (S/D)	Fédération Internationale de Football Association (FIFA)	09/03/2021	194
522117	11/08/2022	URUNDAY (mixta)	30 (S/D)	La Cachuera S.A.	08/06/2021	194
522118	11/08/2022	XEROX	2, 3, 5, 7, 8, 9, 10, 11 y 16	XEROX CORPORATION	18/03/2021	34
522119	12/08/2022	ALLURE	34	COMPAÑIA INDUSTRIAL DE TABACOS MONTE-PAZ S.A.	01/06/2021	245
522120	12/08/2022	TELEPEAJE CORPORACIÓN VIAL DEL URUGUAY (mixta)	39	CORPORACIÓN VIAL DEL URUGUAY S.A.	15/04/2021	245
522121	12/08/2022	TONNA	4 (S/D)	SHELL BRANDS INTERNATIONAL AG	31/05/2021	165

N° Exp	Resolución	Denominación	Clases	Titular	Vigencia	Ag.
522123	12/08/2022	GADUS	4 (S/D)	SHELL BRANDS INTERNATIONAL AG	31/05/2021	165
522124	12/08/2022	MELINA (mixta)	4 (S/D)	SHELL BRANDS INTERNATIONAL AG	31/05/2021	165
522127	12/08/2022	CIRCADIN	5 (S/D)	NEURIM PHARMACEUTICALS (1991)LTD.	14/03/2021	34
522128	12/08/2022	GADINIA (mixta)	4 (S/D)	SHELL BRANDS INTERNATIONAL AG	31/05/2021	165
522130	12/08/2022	BURBERRY TOUCH	3 (S/D)	BURBERRY LIMITED	07/05/2021	165
522131	12/08/2022	OLAVE	29 (S/D) y 30 (S/D)	Soho SpA.	10/03/2021	144
522169	12/08/2022	POWER RUSH	3 (S/D)	THE GILLETTE COMPANY LLC	29/04/2021	212
522170	12/08/2022	HERNANDEZ HNOS.	29, 30 y 35 (S/D)	ALCIDES Y BOLIVAR HERNANDEZ LTDA	12/03/2021	220
522172	12/08/2022	TROPICAL (mixta)	32 (S/D)	DISTRIBUIDORA LA FLORIDA, S. A.	22/03/2021	181
522175	12/08/2022	POSITIVO (mixta)	9 (S/D)	POSITIVO TECNOLOGIA S.A.	18/03/2021	212
522177	12/08/2022	TEHALIT	6 (S/D), 9 (S/D) y 17 (S/D)	TEHALIT GmbH	22/06/2021	219
522179	12/08/2022	SUSPEN TECH (mixta)	12 (S/D)	SUSPEN TECH INDUSTRIA DE COMPONENTES AUTOMOTIVOS LTDA.	21/03/2021	34
522181	12/08/2022	(figurativa)	5 (S/D), 10 (S/D) y 44 (S/D)	FRESENIUS MEDICAL CARE DEUTSCHLAND GMBH	19/04/2021	34
522184	12/08/2022	PETRILAC 7 VIDAS	2 (S/D)	QUIMICA DEL NORTE S.A.	23/08/2021	144
522185	12/08/2022	PETRILAC	2	QUIMICA DEL NORTE S.A.	01/04/2021	144
522186	12/08/2022	TRIMAX	1 (S/D)	Carestream Health, Inc.	27/06/2021	144
522187	12/08/2022	HECHOACA (mixta)	41 y 43	TODOS POR URUGUAY	16/04/2021	154
522188	12/08/2022	LOS OLIVOS BARRIOS DEL POLO (mixta)	35, 36 y 37	URBANIZADORA LOS OLIVOS S.A.	10/03/2021	34
522189	12/08/2022	CORRINA HOUSEWARES	8 y 21	Imporex S.A.	13/04/2021	194
522190	12/08/2022	THIN OS	9	Dell Inc.	06/04/2021	144
522191	12/08/2022	WYSE (mixta)	9 (S/D) y 42 (S/D)	DELL INC.	13/04/2021	144

N° Exp	Resolución	Denominación	Clases	Titular	Vigencia	Ag.
522192	12/08/2022	INTRALIPID	1 (S/D) y 5	Fresenius Kabi AB	31/05/2021	34
522194	12/08/2022	M LABORATORIOS MICROSULES (mixta)	5 (S/D) y 44	LABORATORIOS MICROSULES URUGUAY S.A.	14/03/2021	
522195	12/08/2022	"ENROPET"	5	SEPO INDÚSTRIA E COMÉRCIO LTDA.	23/03/2021	34
522197	12/08/2022	MUSA	3 y 5	LABORATORIOS MICROSULES URUGUAY S.A.	16/03/2021	
522198	12/08/2022	"ANASEDAN"	5	SEPO INDÚSTRIA E COMÉRCIO LTDA.	23/03/2021	34
522200	12/08/2022	SINTONIA DE NATURA	3	NATURA COSMÉTICOS S/A	05/04/2021	34
522201	12/08/2022	CHOCOLINAS	30 (S/D)	BAGLEY ARGENTINA S.A.	14/03/2021	154
522202	12/08/2022	GITI (mixta)	12	GITI TIRE PTE. LTD.	18/08/2021	34
522203	12/08/2022	ORGA-LENT	9	JIKI S.A.	09/05/2021	201
522204	12/08/2022	GT RADIAL (mixta)	12 (S/D)	GITI TIRE PTE. LTD.	13/04/2021	34
522205	12/08/2022	ERA MIO	25 y 28	PEREZ MORATORIO, MARIA JOSE	17/03/2021	201
522207	12/08/2022	EFFIE	35 y 41	EFFIE WORLDWIDE INC.	28/03/2021	201
522208	12/08/2022	(figurativa)	35 y 41	EFFIE WORLDWIDE INC.	29/03/2021	201
522216	12/08/2022	THOMAS (mixta)	21 (S/D)	ROSENTHAL GmbH	17/03/2021	194
522217	12/08/2022	PYREX	21 (S/D)	CORNING INCORPORATED	22/03/2021	194
522219	12/08/2022	ROCKEFELLER	35 (S/D) y 36 (S/D)	1979 Family Trust Licensor, LLC	24/03/2021	194
522221	12/08/2022	STABILIZER	10 (S/D)	Cardinal Health 529, LLC	05/04/2021	194
522232	12/08/2022	OCS (mixta)	39 (S/D)	OVERSEAS COURIER SERVICE CO., LTD.	05/09/2021	221
522235	12/08/2022	CEVAC	5 (S/D)	CEVA SANTE ANIMALE	06/09/2021	34
522246	15/08/2022	MELOVINE	5 (S/D)	CEVA SANTE ANIMALE	27/06/2021	34
522251	15/08/2022	NERF	28	HASBRO INTERNATIONAL, INC.	02/05/2021	212
522252	15/08/2022	LIFE	28	HASBRO INTERNATIONAL, INC.	02/05/2021	212
522254	15/08/2022	RISK	28	HASBRO INTERNATIONAL, INC.	02/05/2021	212
522255	15/08/2022	DYNAMOGEN	5	BALIARDA S.A.	22/03/2021	201
522257	15/08/2022	COMARO	39	COMAS AROCENA S.A.	23/03/2021	245

N° Exp	Resolución	Denominación	Clases	Titular	Vigencia	Ag.
522259	15/08/2022	ADIVINA QUIEN	28	HASBRO INTERNATIONAL INC.	03/05/2021	212
522261	15/08/2022	PETZI	5	SEPO INDÚSTRIA E COMÉRCIO LTDA.	16/05/2021	34
522263	15/08/2022	GUABI (mixta)	31 (S/D)	Guabi Nutrição e Saúde Animal Ltda.	25/04/2021	181
522264	15/08/2022	NUTRIUM MOISTURE	3 (S/D)	Unilever Global IP Limited	30/06/2021	136
522266	15/08/2022	GRUNDFOS	7 (S/D) y 11 (S/D)	GRUNDFOS HOLDING A/S	22/03/2021	192
522267	15/08/2022	CARBUMAN	5 (S/D)	INTERVET INC.	26/04/2021	192
522268	15/08/2022	ECO FRIENDLY (mixta)	9 y 11	PABLO GARCIA REQUENA	05/04/2021	34
522270	15/08/2022	HALSPAN	19 (S/D)	HALSPAN LIMITED	23/03/2021	192
522273	15/08/2022	DESTREZA	28	HASBRO INTERNATIONAL INC.	03/05/2021	212
522274	15/08/2022	ANGENSCHIEDT	10	EMARLAN S.A.	12/03/2021	94
522275	15/08/2022	ARNO (mixta)	21	SEB DO BRASIL PRODUTOS DOMÉSTICOS LTDA.	06/09/2021	34
522276	15/08/2022	MAPA SISTEMAS GRAFICOS S.A. (mixta)	37	MAPA S.A.	21/08/2021	192
522277	15/08/2022	ARNO (mixta)	21	SEB DO BRASIL PRODUTOS DOMÉSTICOS LTDA.	06/09/2021	34
522278	15/08/2022	ZONAPRINT (mixta)	7, 9 y 16	MOSCA HNOS. S.A.	30/03/2021	192
522285	15/08/2022	KANEBO (mixta)	3, 5, 18, 21, 25, 30 y 32	KAO KABUSHIKI KAISHA COMERCIALIZANDO TAMBIÉN COMO KAO CORPORATION	10/08/2021	221
522290	15/08/2022	ING	35 y 36	ING GROEP N.V.	19/03/2021	194
522294	15/08/2022	MECCANO	28 (S/D)	MECCANO	22/03/2021	216
522298	15/08/2022	RINCON FAMOSO	33 (S/D)	BODEGAS Y VIÑEDOS LOPEZ S.A.I.C.	31/05/2021	144
522300	15/08/2022	KINI (mixta)	16, 28, 36, 38 y 41	BANCA DE CUBIERTA COLECTIVA DE QUINIÉLAS DE MONTEVIDEO	14/03/2021	245
522302	15/08/2022	NIMO-SOMAZINA	5	FERRER INTERNACIONAL, S.A.	08/05/2021	34
522303	15/08/2022	DISLEP	5	FERRER INTERNACIONAL, S.A.	09/08/2021	34
522304	15/08/2022	GLOBUSTYL	5	PRODUCTOS FARMACEUTICOS S.A. DE C.V.	12/09/2021	34

N° Exp	Resolución	Denominación	Clases	Titular	Vigencia	Ag.
522305	15/08/2022	GERBER (mixta)	8, 9, 11, 18, 20, 21 y 24	Société des Produits Nestlé S.A.	12/06/2021	34
522307	15/08/2022	EFEECTO CINE (mixta)	41	VARELA, ANDRÉS	08/04/2021	189
522308	15/08/2022	SANITARIA MALDONADO (mixta)	35	AMARRAS DE RIO S.A.	21/03/2021	194
522311	15/08/2022	TIGRE (mixta)	11, 17 y 19	TIGRE SA PARTICIPAÇÕES	17/03/2021	201
522312	15/08/2022	GREEN WORKS	3 y 5	THE CLOROX COMPANY	24/03/2021	228
522315	15/08/2022	DULCES SUEÑOS	5 y 30	Instituto Botánico La Selva S.A.	11/06/2021	205
522321	15/08/2022	GIOTTO	30	SOREMARTEC S.A.	12/06/2021	34
522326	15/08/2022	HYUNDAI CORPORATION (mixta)	35 (S/D)	HYUNDAI CORPORATION	04/07/2021	144
522330	15/08/2022	NOVOTELY	5	ZODIAC INTERNATIONAL CORPORATION	10/05/2021	245
522332	15/08/2022	AIR LIQUIDE	5 (S/D), 10 (S/D), 42 (S/D) y 44 (S/D)	L'AIR LIQUIDE SOCIÉTÉ ANONYME POUR L'ETUDE ET L'EXPLOITATION DES PROCÉDÉS GEORGES CLAUDE	04/05/2021	144
522333	15/08/2022	PRINAMEL	5	ZODIAC INTERNATIONAL CORPORATION	06/05/2021	245
522334	15/08/2022	THE MENTHOL AUTHORITY	34 (S/D)	British American Tobacco (Brands) Inc.	07/04/2021	194
522335	15/08/2022	PRO PAC	31	MIDWESTERN PET FOODS, INC.	05/09/2021	245
522337	15/08/2022	TOYOTOMI	11 (S/D)	TOYOTOMI CO., LTD	06/09/2021	245
522345	16/08/2022	PREGONERO	16	ASOCIACION NACIONAL DE REMATADORES Y CORREDORES	18/03/2021	144
522348	16/08/2022	(figurativa)	3	THE BURT'S BEES PRODUCTS COMPANY	29/03/2021	228
522349	16/08/2022	(figurativa)	3	THE BURT'S BEES PRODUCTS COMPANY	29/03/2021	228
522350	16/08/2022	BURT'S	3	THE BURT'S BEES PRODUCTS COMPANY	29/03/2021	228
522351	16/08/2022	BURT'S BEES	3	THE BURT'S BEES PRODUCTS COMPANY	29/03/2021	228
522352	16/08/2022	BABY BEE (mixta)	3	THE BURT'S BEES PRODUCTS COMPANY	29/03/2021	228



N° Exp	Resolución	Denominación	Clases	Titular	Vigencia	Ag.
522353	16/08/2022	BABY BEE	3	THE BURT'S BEES PRODUCTS COMPANY	29/03/2021	228
522354	16/08/2022	(figurativa)	3 y 5	THE BURT'S BEES PRODUCTS COMPANY	23/06/2021	228
522357	16/08/2022	RAFFO	5	LABORATORIOS RAFFO S.A.	06/09/2021	245
522361	16/08/2022	(figurativa)	29 (S/D) y 30 (S/D)	Société des Produits Nestlé S.A.	15/04/2021	34
522364	16/08/2022	PARCILLINA UBRE JET	5	AGROINSUMOS S.A.	01/09/2021	165
522365	16/08/2022	CEFTIOFORTE PLUS	5	AGROINSUMOS S.A.	01/09/2021	165
522366	16/08/2022	FANTEL FORTE	5	AGROINSUMOS S.A.	01/09/2021	165
522367	16/08/2022	VITAPROFENO FORTE	5	AGROINSUMOS S.A.	01/09/2021	165
522369	16/08/2022	HEMO PLUS FORTE	5	AGROINSUMOS S.A.	01/09/2021	165
522370	16/08/2022	SELFOS	5	AGROINSUMOS S.A.	12/06/2021	165
522372	16/08/2022	PARCILLINA	5 (S/D)	AGROINSUMOS S.A.	11/07/2021	165
522374	16/08/2022	SCOTTS (mixta)	1 (S/D)	OMS Investments, Inc.	03/06/2021	194
522375	16/08/2022	IZOD	25	PVH CORP.	29/03/2021	201
522388	16/08/2022	QUIEN ES EL CULPABLE	28	HASBRO INTERNATIONAL INC.	03/05/2021	212
522390	16/08/2022	UHLSPORT (mixta)	18, 22 y 28	UHLSPORT GMBH	05/04/2021	194
522391	16/08/2022	MKB	12	DECELESTE S.A.	19/03/2021	189
522392	16/08/2022	MINI (mixta)	12 (S/D), 25 (S/D) y 28 (S/D)	Bayerische Motoren Werke Aktiengesellschaft	07/04/2021	194
522393	16/08/2022	NESCAFE (mixta)	29 y 30	Société des Produits Nestlé S.A.	08/05/2021	34
522394	16/08/2022	CLUE	28	HASBRO INTERNATIONAL INC.	03/05/2021	212
522395	16/08/2022	SOSPECHA	28	HASBRO INTERNATIONAL, INC.	03/05/2021	212
522396	16/08/2022	LA VERDADERA MAGIA PASA EN LA COCINA	29 (S/D) y 30 (S/D)	Société des Produits Nestlé S.A.	10/05/2021	34
522397	16/08/2022	GATI	31	Société des Produits Nestlé S.A.	25/05/2021	34
522398	16/08/2022	SEGUNDA CARTUJA (mixta)	35	JAVIER CALVO	03/05/2021	220
522400	16/08/2022	NESCAFÉ (mixta)	29, 30, 32, 35 y 43	Société des Produits Nestlé S.A.	08/05/2021	34
522402	16/08/2022	AGUILA	30 (S/D)	Société des Produits Nestlé S.A.	31/05/2021	34
522405	16/08/2022	CAFE NESCAFE (mixta)	29, 30 (S/D), 32, 35	Société des Produits Nestlé S.A.	07/06/2021	34

N° Exp	Resolución	Denominación	Clases	Titular	Vigencia	Ag.
			y 43			
522406	16/08/2022	CAPENON	5 (S/D)	DAIICHI SANKYO COMPANY, LIMITED	20/06/2021	192
522407	16/08/2022	OLMETECAMLO	5 (S/D)	DAIICHI SANKYO COMPANY, LIMITED	04/04/2021	192
522408	16/08/2022	BENICARAMLO	5 (S/D)	DAIICHI SANKYO COMPANY, LIMITED	04/04/2021	192
522410	16/08/2022	DEVI	9 y 11	Danfoss A/S	05/04/2021	192
522411	16/08/2022	1881 (mixta)	3 (S/D)	CERRUTI 1881	18/04/2021	192
522414	16/08/2022	HAGALO USTED (mixta)	2	PINTURAS GRANITOL S.A.	19/03/2021	201
522415	16/08/2022	CANNONDALE	12 y 25	Cycling Sports Group, Inc.	08/04/2021	136
522416	16/08/2022	NSA NUESTRA SEÑORA DE LA ASUNCION (mixta)	39 (S/D)	NUESTRA SEÑORA DE LA ASUNCION COMERCIAL E INDUSTRIAL S.A.	23/03/2021	201
522419	16/08/2022	CAUPLAS	12	CAUPLAS S.R.L.	31/03/2021	201
522420	17/08/2022	.T...MOBILE. (mixta)	9 (S/D), 38 (S/D) y 42 (S/D)	DEUTSCHE TELEKOM AG	25/04/2021	245
522421	16/08/2022	LISTERINE CUIDADO TOTAL	3 (S/D)	JOHNSON & JOHNSON	11/04/2021	194
522422	17/08/2022	T-MOBILE (mixta)	9 (S/D), 38 (S/D) y 42 (S/D)	DEUTSCHE TELEKOM AG	25/04/2021	245
522424	17/08/2022	ECLIPSE	30 (S/D)	WM. WRIGLEY JR. COMPANY	16/09/2021	245
522425	17/08/2022	LISTERINE	21 (S/D)	JOHNSON & JOHNSON	09/05/2021	194
522428	17/08/2022	BLINK-N-CLEAN	5 (S/D)	Johnson & Johnson Surgical Vision, Inc.	10/05/2021	194
522429	17/08/2022	A AGRALE (mixta)	7 y 12	AGRALE S.A.	12/09/2021	245
522430	17/08/2022	OXYSEPT COMFORT	5 (S/D)	Johnson & Johnson Surgical Vision, Inc.	29/03/2021	194
522431	17/08/2022	CLARIFLEX	10 (S/D)	Johnson & Johnson Surgical Vision, Inc.	05/04/2021	194
522432	17/08/2022	TOP TO TOE	3 (S/D), 5 (S/D), 16 (S/D) y 21 (S/D)	JOHNSON & JOHNSON	16/04/2021	194
522435	17/08/2022	KARBOSAN (mixta)	7 (S/D) y 8 (S/D)	KARBOSAN ZIMPARA TASI SANAYI ANONIM SIRKETI	17/08/2021	144
522437	17/08/2022	VICRYL	10 (S/D)	JOHNSON & JOHNSON	23/05/2021	194

N° Exp	Resolución	Denominación	Clases	Titular	Vigencia	Ag.
522438	17/08/2022	TYLENOL	5 (S/D)	JOHNSON & JOHNSON	23/05/2021	194
522439	17/08/2022	PREVENCIÓN COMPAÑÍA DE SEGUROS S.A.	36 (S/D)	SANCOR COOPERATIVA DE SEGUROS LIMITADA	07/05/2021	34
522441	17/08/2022	SUCARYL SUCRALOSA (mixta)	1 (S/D) y 30 (S/D)	MERISANT COMPANY 2 SARL	04/04/2021	194
522444	17/08/2022	OPTILIFE	31 (S/D)	Société des Produits Nestlé S.A.	01/06/2021	34
522446	17/08/2022	CAMARA URUGUAYA DEL DISCO CUD	41	CAMARA URUGUAYA DEL DISCO	24/03/2021	52
522449	17/08/2022	ESPRESSO AMERICANO (mixta)	43	SERVICIOS EXPOMAR CORP.	18/03/2021	234
522458	17/08/2022	CARGAS DEL ATLÁNTICO (mixta)	39	FEMAWOR S.A.	12/01/2021	
522459	17/08/2022	SIÑERIZ FREE SHOP (mixta)	35, 36, 38, 39, 43 y 44	MABO SOCIEDAD LIMITADA	25/03/2021	189
522472	17/08/2022	(tridimensional)	12	PERFECT FIT INDUSTRIES, INC.	08/09/2021	245
522473	17/08/2022	PFI (mixta)	12	PERFECT FIT INDUSTRIES, INC.	18/03/2021	245
522479	17/08/2022	MAGLÉ BIONAGRIN (mixta)	3	Bionagrin Ltda.	18/03/2021	101
522480	17/08/2022	FIFA WORLD CUP	1 (S/D), 3 (S/D), 4 (S/D), 6 (S/D), 7 (S/D), 8 (S/D), 9 (S/D), 11 (S/D), 12 (S/D), 14 (S/D), 16 (S/D), 18 (S/D), 25 (S/D), 28 (S/D), 29 (S/D), 30 (S/D), 32 (S/D), 34 (S/D), 35 (S/D), 36 (S/D), 37 (S/D), 38 (S/D), 40 (S/D), 41 (S/D), 42 (S/D), 43 (S/D) y 44 (S/D)	Fédération Internationale de Football Association (FIFA)	19/03/2021	194
522481	17/08/2022	GERARD DAREL	3 (S/D)	HGD GROUP	13/04/2021	165
522482	17/08/2022	BN TOURS CITY CENTER	39	BN TOURS S.A.	25/03/2021	194
522484	17/08/2022	BN TOURS	39	BN TOURS S.A.	25/03/2021	194

N° Exp	Resolución	Denominación	Clases	Titular	Vigencia	Ag.
522485	17/08/2022	RCA (mixta)	9 (S/D)	RCA Trademark Management	18/04/2021	194
522486	17/08/2022	PIAGET (mixta)	3 (S/D), 9 (S/D), 14 (S/D) y 16 (S/D)	RICHEMONT INTERNATIONAL S.A.	18/04/2021	194
522491	17/08/2022	LOS 4 ASES (mixta)	25	LOS 4 ASES S.A.	27/05/2021	220
522492	17/08/2022	OPERANDO	28	HASBRO INTERNATIONAL, INC.	03/05/2021	212
522493	17/08/2022	(figurativa)	2 y 16	PINTURAS INCA S.A.	24/05/2021	34
522494	17/08/2022	TONKA	28	HASBRO INTERNATIONAL INC.	08/05/2021	212
522496	17/08/2022	PRÜNE (mixta)	3, 9 y 14	Prüne S.A.	25/03/2021	34
522497	17/08/2022	KEMADRIN	5 (S/D)	Aspen Global Incorporated	05/04/2021	201
522498	17/08/2022	BONITA	31	FRUIT SHIPPERS LIMITED	03/09/2021	212
522499	17/08/2022	GINEMAXIM	5	KNOP LABORATORIOS S.A.	05/04/2021	201
522500	17/08/2022	NIRVANA	1 (S/D), 2 (S/D), 7 (S/D), 9 (S/D), 16 (S/D) y 20 (S/D)	HOTEL NIRVANA S.A.	22/03/2021	179
522501	17/08/2022	BOTOX BOTULINUM TOXIN TYPE A PURIFIED NEUROTOXIN COMPLEX (mixta)	16 (S/D)	ALLERGAN, INC.	06/04/2021	201
522505	17/08/2022	TAGTEAM	1 (S/D)	Novozymes A/S	08/04/2021	201
522508	17/08/2022	TERAOKA	9 y 37	CITEK LTDA.	18/04/2021	201
522509	17/08/2022	CITEK LTDA (mixta)	9 y 37	CITEK LTDA.	18/04/2021	201
522516	17/08/2022	ZARZIO	5 (S/D)	NOVARTIS AG	15/09/2021	201
522522	17/08/2022	VIESA	9, 11 y 12	COL-VEN S.A.	26/07/2021	94
522524	18/08/2022	ROUGE HERMES (mixta)	3 (S/D)	HERMES INTERNATIONAL	05/04/2021	245
522526	18/08/2022	PETROSSIAN	30 (S/D) y 33 (S/D)	CAVIAR PETROSSIAN, SOCIÉTÉ ANONYME	08/04/2021	34
522527	18/08/2022	SUPERMERCADO LA BOHEMIA (mixta)	35	PIAGGIO, FERNANDO y PIAGGIO, GUSTAVO	22/03/2021	189
522528	18/08/2022	XTERIVET	5 (S/D)	EMARLAN S.A.	24/03/2021	94
522529	18/08/2022	XTERICOLD	5 (S/D)	EMARLAN S.A.	24/03/2021	94
522531	18/08/2022	GRAN HERMANO	28 (S/D) y 41 (S/D)	Endemol Shine Nederland Producties B.V.	23/03/2021	136

N° Exp	Resolución	Denominación	Clases	Titular	Vigencia	Ag.
522532	18/08/2022	BIG BROTHER	28 (S/D) y 41 (S/D)	Endemol Shine Nederland Producties B.V.	23/03/2021	136
522534	18/08/2022	VAT 69 (mixta)	33 (S/D)	DIAGEO BRANDS B.V.	23/05/2021	212
522535	18/08/2022	GELAFRUIT (mixta)	29	QUESERIA HELVETICA S.A.	08/04/2021	129
522539	18/08/2022	YESI	21	MARIO ANTONIO CANIGLIA	19/03/2021	34
522540	18/08/2022	PRONTOLAT	29	Gloria Foods del URUGUAY S.A.	05/04/2021	221
522542	18/08/2022	LISTOLAT	29	Gloria Foods del URUGUAY S.A.	05/04/2021	221
522543	18/08/2022	PV LEHMEYUNERIA PONTE VECCHIO (mixta)	43	Maribel Machado	21/03/2021	
522545	18/08/2022	INTIMISSIMI IL TUO NEGOZZIO DI INTIMO (mixta)	25	SIKELMAR S.A.	20/04/2021	194
522546	18/08/2022	569	25	LEVI STRAUSS & CO.	25/04/2021	194
522547	18/08/2022	FACTIVE	5 (S/D)	LG CHEM, LTD.	06/09/2021	194
522554	18/08/2022	LA MARTINA (mixta)	41 (S/D)	CAPINEL S.A.	11/04/2021	118
522558	18/08/2022	DIVOS	3 (S/D)	DIVERSEY IP INTERNATIONAL B.V.	16/05/2021	144
522559	18/08/2022	DIVOS	1 (S/D) y 9 (S/D)	DIVERSEY IP INTERNATIONAL B.V.	16/05/2021	144
522567	18/08/2022	DANISH CROWN (mixta)	29 (S/D)	DANISH CROWN A/S	08/04/2021	94
522569	18/08/2022	NUCLISENS EASYQ	5 (S/D) y 10 (S/D)	bioMérieux	17/09/2021	144
522574	18/08/2022	RAUSA (mixta)	29 (S/D)	EDIC S.A.	22/03/2021	154
522576	18/08/2022	RAUSA SELLO ROJO (mixta)	29 (S/D)	EDIC S.A.	23/08/2021	154
522580	18/08/2022	HESSEN R (mixta)	7	RECORD TOOLS S.A.	04/04/2021	221
522582	18/08/2022	IVAX	5 y 10	IVAX LLC	25/04/2021	245
522588	18/08/2022	KENOPEL	5 (S/D)	Adama Irvita N.V.	23/03/2021	194
522596	18/08/2022	MULTI CORREXION	3 (S/D) y 5 (S/D)	RoC Opco LLC	29/03/2021	194
522597	18/08/2022	ASUNTOL	1 (S/D) y 5 (S/D)	Bayer Animal Health GmbH	31/05/2021	205
522599	18/08/2022	ADALAT OROS	5 (S/D)	Bayer Intellectual Property GmbH	27/05/2021	205
522600	18/08/2022	ESPLANADE	5 (S/D)	Bayer Intellectual Property GmbH	05/05/2021	205
522601	18/08/2022	NATURAL CAT ALIMENTO BALANCEADO PARA GATOS ANIMAL FOOD (mixta)	31 (S/D)	LODYTEX S.A.	23/03/2021	34
522602	18/08/2022	BR PETROBRAS AVIATION (mixta)	37 (S/D)	PETROLEO BRASILEIRO S.A. -	24/03/2021	94

N° Exp	Resolución	Denominación	Clases	Titular	Vigencia	Ag.
				PETROBRAS		
522603	18/08/2022	NATURAL DOG ALIMENTO BALANCEADO PARA PERROS ANIMAL FOOD (mixta)	31 (S/D)	LODYTEX S.A.	23/03/2021	34
522606	18/08/2022	BEPANTHEN	5 (S/D)	BAYER CONSUMER CARE AG	23/05/2021	205
522611	18/08/2022	CANESPIE	5 (S/D)	BAYER AKTIENGESELLSCHAFT	24/05/2021	205
522615	18/08/2022	MAGNEVISTAN	5	Bayer Intellectual Property GmbH	27/05/2021	205
522616	18/08/2022	ANGELIQ	5 (S/D)	Bayer Intellectual Property GmbH	02/05/2021	205
522618	18/08/2022	COSMO	41 (S/D)	HEARST COMMUNICATIONS, INC.	13/04/2021	156
522620	18/08/2022	CLIANE	5	Bayer Intellectual Property GmbH	27/05/2021	205
522624	18/08/2022	HIDRO-TEC (mixta)	37	German Sosa y Raul Frigerio Vidal	29/03/2021	101
522626	18/08/2022	LEMAC	37	LEMAC LIMITADA	29/03/2021	189
522627	18/08/2022	KOTEX	5	KIMBERLY-CLARK WORLDWIDE, INC.	26/04/2021	34
522630	19/08/2022	FOSS	1 (S/D), 5 (S/D), 9 (S/D) y 42 (S/D)	FOSS A/S	20/05/2021	156
522633	19/08/2022	COOK PET	31	TORRIERI DICONO, RAÚL ALBERTO	29/03/2021	189
522634	19/08/2022	GOOD PET	31	TORRIERI DICONO, RAÚL ALBERTO	29/03/2021	189
522635	19/08/2022	DALMATA	24	BOGIATZIÁN, OHANES	28/03/2021	189
522643	19/08/2022	BOM BRIL LIMPOL (mixta)	3 (S/D)	BRIL COSMÉTICOS S/A	14/09/2021	144
522650	19/08/2022	VITAMINWATER (mixta)	32	ENERGY BRANDS INC.	10/05/2021	94
522653	19/08/2022	FANTA	29 (S/D) y 30 (S/D)	THE COCA-COLA COMPANY	31/05/2021	94
522655	19/08/2022	SPRITE (mixta)	29 (S/D) y 30 (S/D)	THE COCA-COLA COMPANY	31/05/2021	94
522661	19/08/2022	TIENDAS MONTEVIDEO (mixta)	14, 16, 18, 20, 24, 25, 27 y 35	Grandes Tiendas Montevideo S.A.	07/04/2021	172
522663	19/08/2022	INDUMEX	16, 35, 36 y 45	INDUMEX S.A.	27/05/2021	201
522664	19/08/2022	NEW MECTIN	5 (S/D)	RIVERDOR CORP. S.A.	04/05/2021	201
522665	19/08/2022	REVERDECER (mixta)	31 y 44	DANIEL CELLA y MARCELO VERONESI	25/04/2021	201
522673	19/08/2022	CITROËN C5	12 (S/D)	AUTOMOBILES CITROËN	29/03/2021	192

N° Exp	Resolución	Denominación	Clases	Titular	Vigencia	Ag.
522676	19/08/2022	LEVIPAN	1	QUIMICA S.A.	29/03/2021	192
522678	19/08/2022	NOVAPOL	1 (S/D) y 17 (S/D)	NOVA CHEMICALS (INTERNATIONAL) S.A.	08/04/2021	34
522691	19/08/2022	ONYX FIRSTVISION	9 (S/D)	HONEYWELL INTERNATIONAL INC.	25/04/2021	34
522692	19/08/2022	MAGISTRAL	25	DAGOL S.A.	31/03/2021	245
522694	19/08/2022	MODALITE	16	FACUNDO CESAR ORTIZ	28/03/2021	245
522695	19/08/2022	IDEAS CLARO	38 (S/D)	CLARO S.A.	04/04/2021	181
522696	19/08/2022	IDEAS CLARO	9 (S/D)	CLARO S.A.	11/04/2021	181
522697	19/08/2022	RECARGAS CLARO	9 (S/D) y 38 (S/D)	CLARO S.A.	28/04/2021	181
522698	19/08/2022	ICLARO	38 (S/D)	CLARO S.A.	01/09/2021	181
522702	19/08/2022	FUJI ELECTRIC (mixta)	11 (S/D)	FUJI ELECTRIC CO. LTD.	05/04/2021	216
522704	19/08/2022	FORTERA	12 (S/D)	THE GOODYEAR TIRE & RUBBER COMPANY	15/06/2021	216
522705	19/08/2022	TESA (mixta)	6 (S/D), 9 (S/D) y 35 (S/D)	TALLERES DE ESCORIAZA, S.A.	06/05/2021	216
522706	19/08/2022	FREEWAY	1	Loveland Products, Inc.	29/06/2021	220
522707	19/08/2022	ACTIVADOR 90	1	Loveland Products, Inc.	30/06/2021	220
522708	19/08/2022	TACTIC	1	Loveland Products, Inc.	30/06/2021	220
522709	19/08/2022	CASEUS (mixta)	29, 30 y 43	FAROLUR S.A.	04/04/2021	19
522710	19/08/2022	CASEUS (mixta)	29, 30 y 43	FAROLUR S.A.	04/04/2021	19
522712	19/08/2022	PRECISIONGLIDE	10 (S/D)	BECTON DICKINSON AND COMPANY	18/04/2021	34
522715	19/08/2022	MERCK	37	MERCK KGaA	05/04/2021	129
522716	19/08/2022	SEAL - O - MATIC (mixta)	1 y 12	Orrego Ltda.	30/03/2021	101
522717	19/08/2022	LZ	25	CMR INDUSTRIA E COMERCIO LTDA.	19/09/2021	34
522719	19/08/2022	LZ (mixta)	35	CMR INDUSTRIA E COMERCIO LTDA.	19/09/2021	34
522726	19/08/2022	EATALY	35, 41 y 43	Eataly S.p.A.	05/04/2021	144
522729	19/08/2022	ANGELIS AS SUBLIMÉ (mixta)	3	QUIMDOM S.R.L.	06/04/2021	144

N° Exp	Resolución	Denominación	Clases	Titular	Vigencia	Ag.
522730	19/08/2022	MITAS	12 (S/D) y 17 (S/D)	Trelleborg Wheel Systems Czech Republic, a.s.	05/09/2021	34
522734	22/08/2022	BRUNO MINELLI	25	VIA VENETO ROUPAS LTDA.	13/04/2021	34
522736	22/08/2022	AMAZON	16 (S/D)	Amazon Technologies, Inc.	16/04/2021	194
522737	22/08/2022	180 180.COM.UY TU PRIMER CLICK DEL DÍA (mixta)	38 y 41	JOEL ROSENBERG MOSES	28/03/2021	212
522739	22/08/2022	JAUJA	43	HELADOS JAUJA S.A.	25/09/2021	144
522741	22/08/2022	CASALINDA	2	BLECHMAN, MARCELO; PARRILLO, ANTONIO y FORT, FABRICIO	31/03/2021	189
522742	22/08/2022	CREMA DE ORDEÑE-HUMECTANTE-LUBRICANTE-PROTEGE LA PIEL-CON ALOE VERA Y VITAMINA A - LINDON APITER (mixta)	3 (S/D)	APITER SA	15/04/2021	212
522757	22/08/2022	GG (mixta)	3, 9, 14, 18 y 25	GUCCIO GUCCI S.P.A.	03/05/2021	212
522760	23/08/2022	GG (mixta)	3, 9, 14, 18 y 25	GUCCIO GUCCI S.P.A.	03/05/2021	212
522761	23/08/2022	HARINA SANTA ROSA	30 (S/D) y 31	COOPERATIVA DE TRABAJADORES DE MOLINOS SANTA ROSA	11/07/2021	
522762	23/08/2022	(figurativa)	3, 9, 14, 18 y 25	GUCCIO GUCCI S.P.A.	05/05/2021	212
522764	23/08/2022	HUAMIL	6, 11, 21 y 35	ANIBAL VIGNA S.R.L.	05/04/2021	219
522765	23/08/2022	PUNKTAL DECÓ	11	PUNKTAL S.A.	07/04/2021	189
522767	23/08/2022	(figurativa)	3 (S/D) y 9 (S/D)	S. TOUS, S.L.	22/08/2021	212
522769	23/08/2022	EL AGUA EN LAS MEJORES MANOS	35 y 37	HIDRO SERVICE S.R.L.	01/04/2021	94
522770	23/08/2022	TOUS (mixta)	35 (S/D)	S. TOUS, S.L.	22/08/2021	212
522772	23/08/2022	TOUS	35 (S/D)	S. TOUS, S.L.	22/08/2021	212
522774	23/08/2022	GREEN GIANT	29 (S/D)	B&G Foods North America, Inc.	02/10/2020	136
522777	23/08/2022	CENTAURO C (mixta)	35	SBF COMERCIO DE PRODUTOS ESPORTIVOS LTDA.	05/04/2021	201
522778	23/08/2022	CP CONTROLPUMPS (mixta)	7	HIDRO SERVICE S.R.L.	17/09/2021	94
522780	23/08/2022	HISER (mixta)	7, 35 y 37	HIDRO SERVICE S.R.L.	17/09/2021	94
522785	23/08/2022	GALERIA DE BUSQUEDA (mixta)	16	EDITORIAL AGORA S.A.	05/04/2021	194



N° Exp	Resolución	Denominación	Clases	Titular	Vigencia	Ag.
522788	23/08/2022	ALAMAR (mixta)	37	MARIA DEL CARMEN LOPEZ LOPEZ	05/04/2021	34
522789	23/08/2022	GATES	7, 12 y 17	The Gates Corporation	18/04/2021	136
522794	23/08/2022	PANIDAJE FLEISCHMANN	30	LEVADURA URUGUAYA S.A.	04/04/2021	34
522795	23/08/2022	NUTRIENCE	31 (S/D)	ROLF C. HAGEN, INC.	01/04/2021	192
522797	23/08/2022	RM 99	12 (S/D)	PIRELLI TYRE S.P.A.	05/04/2021	192
522800	23/08/2022	MIDEA (mixta)	7 (S/D)	MIDEA GROUP CO., LTD.	25/09/2021	34
522803	23/08/2022	STREAM	12	HONDA GIKEN KOGYO KABUSHIKI KAISHA (HONDA MOTOR CO., LTD.)	25/06/2021	94
522805	23/08/2022	SHIELD BRITE	1 y 5 (S/D)	PACE INTERNATIONAL, LLC	05/04/2021	245
522806	23/08/2022	LABORATORIOS SZABO (mixta)	5	SZABO S.A.	28/03/2021	245
522809	23/08/2022	ENDURANCE	2	PINTURAS INCA S.A.	12/06/2021	34
522810	23/08/2022	EAU D'ORANGE VERTE-HERMES (mixta)	3 (S/D)	HERMES INTERNATIONAL	04/05/2021	245
522812	23/08/2022	TOBLERONE TOBELLE	30 (S/D)	KRAFT FOODS SCHWEIZ HOLDING GMBH	31/03/2021	245
522814	23/08/2022	REVELAR DE NATURA (mixta)	3	NATURA COSMÉTICOS S/A	11/06/2021	34
522815	23/08/2022	ONGLYZA (mixta)	5 (S/D)	ASTRAZENECA AB	13/07/2021	201
522820	23/08/2022	COLEGIO Y LICEO NUESTRA SEÑORA DE LOURDES (mixta)	16, 25 y 41	ASOCIACION DE LAS HERMANAS HIJAS DE SAN FRANCISCO DE ASIS	29/03/2021	201
522822	23/08/2022	LUBER-FINER (mixta)	7 (S/D)	CHAMPION LABORATORIES, INC.	05/04/2021	194
522825	23/08/2022	NEXIUM	5 (S/D)	ASTRAZENECA AB	09/08/2021	201
522826	23/08/2022	CBK (mixta)	7 (S/D)	FRAMAR S.A.	05/04/2021	212
522827	23/08/2022	UPS UNITED PARCEL SERVICE (mixta)	16, 38 y 39	UNITED PARCEL SERVICE OF AMERICA, INC.	18/04/2021	194
522828	23/08/2022	DROGUERÍA MONTEVIDEO (mixta)	1, 3, 5 y 35	H. RAFULS CAMOU S.A.	07/04/2021	194
522832	23/08/2022	KENMORE	7 (S/D) y 11 (S/D)	Transform SR Brands, LLC	05/04/2021	194
522833	23/08/2022	BNP PARIBAS (mixta)	36 (S/D)	BNP PARIBAS	05/04/2021	194
522835	23/08/2022	ECOSISTEMAS	37	Construcciones Ecológicas S.A. CIC Y A	01/04/2021	101
522836	23/08/2022	RBC	36	ROYAL BANK OF CANADA	16/05/2021	201
522837	23/08/2022	SYRAH	43	Syrah Global S.A.	01/04/2021	101

N° Exp	Resolución	Denominación	Clases	Titular	Vigencia	Ag.
522838	23/08/2022	CHERRY (mixta)	12 (S/D)	Pasaco S.A.	05/04/2021	101
522839	23/08/2022	YESOLAR (mixta)	37	Imolur S.A.	05/04/2021	101
522840	23/08/2022	VIAJES CYNOSA S.A. (mixta)	35, 39 y 43	Carlos Alberto Nuñez Mujica y Diomar Gregorio Nuñez Pereira	04/04/2021	101
522842	24/08/2022	THE BANK FOR A CHANGING WORLD	36 (S/D)	BNP PARIBAS	24/05/2021	194
522851	24/08/2022	LA TORIBIA	29	FEDERICO BONOMI	31/03/2021	144
522852	24/08/2022	LEXDOMAIN	35 y 38	LEXDOMAIN S.A.	05/04/2021	201
522872	24/08/2022	SCT-GERMANY	7 (S/D) y 12 (S/D)	Sudheimer Car Technik Vetriebs GmbH	30/09/2021	144
522873	24/08/2022	MANNOL	4 (S/D)	Sudheimer Car Technik Vetriebs GmbH	23/09/2021	144
522874	24/08/2022	IL BARETTO	43	NICOLAS GARCIA BIANCHI	08/05/2021	144
522875	24/08/2022	SER-SAT	38	SER-SAT S.A.	05/04/2021	228
522876	24/08/2022	ZUKO (mixta)	32 (S/D)	TRESMONTES LUCCHETTI S.A.	04/05/2021	144
522877	24/08/2022	MAMA BEE	3	THE BURT'S BEES PRODUCTS COMPANY	29/03/2021	228
522882	24/08/2022	BQB (mixta)	39 y 43	LOS CIPRESES S.A.	08/04/2021	19
522896	24/08/2022	DOS CAMINOS (mixta)	39	LUMARY S.A.	21/06/2021	201
522900	24/08/2022	INFUSIUM 23	3 (S/D)	HELEN OF TROY LIMITED	27/06/2021	94
522901	24/08/2022	RED LIDER (mixta)	36	FIRST DATA CONO SUR S.A.	20/06/2021	201
522902	24/08/2022	MAYOL & ASOCIADOS	45	INTERGEO S.A.	20/06/2021	201
522930	24/08/2022	(figurativa)	14, 16, 18, 20, 24, 25, 27 y 35	Grandes Tiendas Montevideo S.A.	07/04/2021	172
522937	24/08/2022	LAND-RIN	5 (S/D)	LANDRIN INDUSTRIA E COMERCIO DE INSETICIDAS LTDA.	26/04/2021	220
522944	24/08/2022	NVC (mixta)	11	NVC GLOBAL SOLUTIONS LIMITED	11/07/2021	34
522951	24/08/2022	GSK (mixta)	1 (S/D), 3 (S/D), 5 (S/D), 9 (S/D), 10 (S/D), 16 (S/D), 21 (S/D), 29 (S/D), 30 (S/D), 32 (S/D), 35 (S/D), 41 (S/D), 42	SMITHKLINE BEECHAM LIMITED	03/05/2021	216

N° Exp	Resolución	Denominación	Clases	Titular	Vigencia	Ag.
			(S/D) y 44 (S/D)			
522953	24/08/2022	PULSE (mixta)	36	Pulse Network LLC	07/04/2021	194
522955	24/08/2022	FLEXPEN	10 (S/D)	NOVO NORDISK A/S	11/06/2021	181
522957	24/08/2022	JOSE CUERVO MARGARITA MIX	32 (S/D)	TEQUILA CUERVO, S.A. DE C.V.	08/04/2021	194
522958	24/08/2022	PEPSI KICK	32 (S/D)	PEPSICO, INC. UNA CORPORACION DEL ESTADO DE CAROLINA DEL NORTE	11/04/2021	201
522959	24/08/2022	MAX LIFE	4 (S/D)	VALVOLINE LICENSING AND INTELLECTUAL PROPERTY LLC	02/02/2021	216
522960	24/08/2022	CAMELION (mixta)	9 y 11	CAMELION BATTERY CO., LTD.	01/06/2021	216
522961	24/08/2022	ORACLE	9, 16, 41 y 42	ORACLE INTERNATIONAL CORPORATION	27/05/2021	194
522973	24/08/2022	MARAFLEX	16 (S/D)	BEMIS COMPANY, INC.	16/04/2021	34
522979	24/08/2022	TN	16 y 38	TIEMPO NUEVO S.R.L.	08/04/2021	181
522986	24/08/2022	RUSSKAYA RUSSIAN VODKA (mixta)	33 (S/D)	FKP SOJUZPLODOIMPORT	16/05/2021	144
522987	24/08/2022	MATADOR	7 (S/D) y 17	CONTINENTAL MATADOR RUBBER S.R.O.	08/06/2021	218
522988	24/08/2022	FARMA CENTER (mixta)	35 y 42	NPS (URUGUAY) S.A.	09/05/2021	34
522990	24/08/2022	ALFA (mixta)	3 (S/D), 5 (S/D), 6 (S/D), 8 (S/D), 11 (S/D), 16 (S/D), 21 (S/D), 29 (S/D), 32 (S/D), 37 (S/D) y 40 (S/D)	TETRA LAVAL HOLDINGS & FINANCE S.A.	08/06/2021	144
522996	24/08/2022	CARPER	35 y 37	DARRIGOL MUÑOZ, ZULMA y PEREIRA QUINTANA, MARTIN	09/06/2021	245
523004	24/08/2022	MANIACKS	29 y 30	PEPSICO INC.	03/05/2021	201
523005	24/08/2022	MANIACKS CRAK	29 y 30	PEPSICO INC.	03/05/2021	201
523006	24/08/2022	(figurativa)	29 y 30	PEPSICO, INC.	04/05/2021	201
523007	24/08/2022	ADMINISTRACION VEIGA (mixta)	36 (S/D)	VEIGA, GUSTAVO DANIEL	07/10/2021	189

N° Exp	Resolución	Denominación	Clases	Titular	Vigencia	Ag.
523008	24/08/2022	BONUS	18	MOLTADEN SOCIEDAD ANÓNIMA	14/04/2021	212
523013	24/08/2022	ISUZU D-MAX (mixta)	12 (S/D)	ISUZU JIDOSHA KABUSHIKI KAISHA (COMERCIANDO TAMBIEN COMO ISUZU MOTORS LIMITED)	20/09/2021	156
523023	24/08/2022	CLEARING DE INFORMES (mixta)	35	EQUIFAX URUGUAY S.A.	09/05/2021	194
523025	24/08/2022	FRONTERA	12	OPEL AUTOMOBILE GmbH	11/07/2021	144
523027	26/08/2022	PERSONAL MILES	39	Mileage Plus Intellectual Property Assets, Ltd.	07/05/2021	194
523029	26/08/2022	BLOOMBERG UNIVERSITY	41 (S/D)	BLOOMBERG FINANCE L.P.	15/06/2021	201
523030	26/08/2022	YPÊ BRILHO (mixta)	3 (S/D) y 21 (S/D)	QUIMICA AMPARO LTDA.	15/06/2021	94
523033	26/08/2022	VITALINEA	29 (S/D)	COMPAGNIE GERVAIS DANONE	05/09/2021	245
523036	26/08/2022	DANAFLEX	29 (S/D) y 32 (S/D)	COMPAGNIE GERVAIS DANONE	12/08/2021	245
523037	26/08/2022	TRI-LUMA	5 (S/D)	NESTLE SKIN HEALTH S.A.	01/10/2021	245
523039	26/08/2022	CHARM (mixta)	34	SOUZA CRUZ LTDA	08/05/2021	194
523049	26/08/2022	ESPRESSION LAVAZZA (mixta)	43 (S/D)	LUIGI LAVAZZA SPA	05/05/2021	34
523051	26/08/2022	ESPRESSION LAVAZZA (mixta)	30 (S/D)	LUIGI LAVAZZA SPA	10/05/2021	34
523052	26/08/2022	CONYMET (mixta)	6 y 37	DURATRAY INVESTMENT PTY LTD	01/07/2021	212
523054	26/08/2022	DURATRAY CONYMET DURATRAY GROUP (mixta)	6 y 12	DURATRAY INVESTMENT PTY LTD	04/07/2021	212
523061	26/08/2022	TECNIAGRO	41	VULTICOR S.A.	16/04/2021	220
523065	26/08/2022	GG, GG, GG, GG, GG (mixta)	3, 9, 14, 18 y 25	GUCCIO GUCCI S.P.A.	07/06/2021	212
523068	26/08/2022	DUNI	30 (S/D)	GERMANI ALIMENTOS LTDA.	11/04/2021	34
523086	26/08/2022	M (mixta)	11 (S/D)	MIDEA GROUP CO. LTD.	09/10/2021	34
523087	26/08/2022	ROTHMANS KING SIZE (mixta)	34 (S/D)	Rothmans of Pall Mall Limited	31/05/2021	194
523090	26/08/2022	DION	1 (S/D)	Reichhold LLC 2	09/05/2021	194
523093	26/08/2022	PUBLIBUS TOTAL (mixta)	35	JCDecaux OOH Uruguay S.A.	04/05/2021	218
523096	26/08/2022	ALPA	29, 30 y 31	COOPERATIVA NACIONAL DE PRODUCTORES DE LECHE (CONAPROLE)	18/04/2021	194
523099	26/08/2022	ALPA	32 y 33	COOPERATIVA NACIONAL DE	18/04/2021	194

N° Exp	Resolución	Denominación	Clases	Titular	Vigencia	Ag.
				PRODUCTORES DE LECHE (CONAPROLE)		
523101	26/08/2022	MANJAR DEL CIELO	1 (S/D), 7 (S/D), 18 (S/D), 20 (S/D), 22 (S/D), 29 (S/D) y 31 (S/D)	COOPERATIVA NACIONAL DE PRODUCTORES DE LECHE (CONAPROLE)	26/04/2021	194
523103	26/08/2022	MANJAR BLANCO	1 (S/D), 7 (S/D), 18 (S/D), 20 (S/D), 22 (S/D), 29 (S/D) y 31 (S/D)	COOPERATIVA NACIONAL DE PRODUCTORES DE LECHE (CONAPROLE)	26/04/2021	194
523104	26/08/2022	MANJAR BLANCO	1 (S/D), 3 (S/D), 4 (S/D), 21 (S/D), 29 (S/D), 30 (S/D), 31 (S/D) y 32 (S/D)	COOPERATIVA NACIONAL DE PRODUCTORES DE LECHE (CONAPROLE)	26/04/2021	194
523106	26/08/2022	MSD	5	Merck Sharp & Dohme Corp.	12/06/2021	192
523108	26/08/2022	OSMOLAX (mixta)	5 (S/D)	SCORPIUS	25/10/2020	104
523111	26/08/2022	STRUKTOL (mixta)	1	Schill + Seilacher "Struktol" GmbH	20/04/2021	104
523115	26/08/2022	CLOPLATIC	5	LABORATORIOS CELSIUS S.A.	30/05/2021	144
523116	26/08/2022	DAPAMIN	5	LABORATORIOS CELSIUS S.A.	06/05/2021	144
523117	26/08/2022	LEVO ATHENA	5	LABORATORIOS CELSIUS S.A.	20/05/2021	144
523118	26/08/2022	RENACER	3	LABORATORIOS CELSIUS S.A.	27/05/2021	144
523120	26/08/2022	ZEFUROX	5	LABORATORIOS CELSIUS S.A.	06/05/2021	144
523123	26/08/2022	HAYFOLIC	5	LABORATORIOS HAYMANN S.A.	28/06/2021	144
523124	26/08/2022	SERFLU	5	LABORATORIOS HAYMANN S.A.	15/06/2021	144
523125	26/08/2022	BELCOMIB	5	Mega Labs S.A.	30/06/2021	144
523126	26/08/2022	BOTEMIB	5	Mega Labs S.A.	30/06/2021	144
523127	26/08/2022	CITABICLOS	5	Mega Labs S.A.	30/06/2021	144
523128	26/08/2022	ENTAXAR	5	Mega Labs S.A.	30/06/2021	144
523130	26/08/2022	FREMIC	5	Mega Labs S.A.	30/06/2021	144
523131	26/08/2022	NOVATOSIN	5	Mega Labs S.a.	23/05/2021	144
523132	26/08/2022	PALIDONAL	5	Mega Labs S.A.	30/06/2021	144

N° Exp	Resolución	Denominación	Clases	Titular	Vigencia	Ag.
523133	26/08/2022	ACI-TIP	5	Megalabs Uruguay S.A.	27/05/2021	144
523134	29/08/2022	ALUZIME	5	Megalabs Uruguay S.A.	27/06/2021	144
523135	29/08/2022	ATOSCLEROL	5	Megalabs Uruguay S.A.	27/05/2021	144
523136	29/08/2022	AVEMUS	5	Megalabs Uruguay S.A.	02/06/2021	144
523137	29/08/2022	DIBACTIL	5	Megalabs Uruguay S.A.	12/06/2021	144
523138	29/08/2022	GABA	5	Megalabs Uruguay S.A.	06/05/2021	144
523139	29/08/2022	M MONTENEGRO (mixta)	12	PRIVALINE S.A.	05/04/2021	194
523140	29/08/2022	NOSTRIL	5 (S/D)	Megalabs Uruguay S.A.	27/05/2021	144
523141	29/08/2022	SYGILUM	5	Megalabs Uruguay S.A.	27/05/2021	144
523142	29/08/2022	TRITAL	5 (S/D)	SPEFAR S.A.	23/05/2021	144
523145	29/08/2022	FACUNDO	33	GRUPO PEÑAFLORES S.A.	18/04/2021	94
523148	29/08/2022	ACTIPERID	5	Mega Labs S.A.	30/06/2021	144
523149	29/08/2022	ACCENTURE	9, 16, 35, 36, 37, 41 y 42	ACCENTURE GLOBAL SERVICES LIMITED	02/05/2021	194
523150	29/08/2022	B BESSER (mixta)	3	Mega Labs S.A.	20/06/2021	144
523151	29/08/2022	B BESSER (mixta)	5	Mega Labs S.A.	20/06/2021	144
523152	29/08/2022	EPITRIOL	5	Mega Labs S.A.	30/06/2021	144
523153	29/08/2022	(figurativa)	5 (S/D)	MERIAL	13/04/2021	245
523154	29/08/2022	NAPROPACK	5	Mega Labs S.A.	01/06/2021	144
523155	29/08/2022	PALIVEGA	5	Mega Labs S.A.	30/06/2021	144
523156	29/08/2022	ROWECOMT	5	Mega Labs S.A.	30/06/2021	144
523157	29/08/2022	ROWEDOPAR	5	Mega Labs S.A.	30/06/2021	144
523158	29/08/2022	VESIRELAX	5	Mega Labs S.A.	30/06/2021	144
523160	29/08/2022	4 TINTAS (mixta)	35 y 40	MUZIO LLADÓ, LAURA	09/05/2021	194
523162	29/08/2022	LEVI'S (mixta)	35 (S/D)	LEVI STRAUSS & CO.	10/05/2021	194
523170	29/08/2022	FIFA (mixta)	1 (S/D), 3 (S/D), 5 (S/D), 6 (S/D), 8 (S/D), 9 (S/D), 10 (S/D), 11 (S/D), 12 (S/D), 14 (S/D), 16	Fédération Internationale de Football Association (FIFA)	19/04/2021	194

N° Exp	Resolución	Denominación	Clases	Titular	Vigencia	Ag.
			(S/D), 18 (S/D), 19 (S/D), 20 (S/D), 21 (S/D), 24 (S/D), 25 (S/D), 27 (S/D), 28 (S/D), 29 (S/D), 30 (S/D), 32 (S/D), 33 (S/D), 35 (S/D), 36 (S/D), 38 (S/D), 39 (S/D), 40 (S/D), 41 (S/D), 42 (S/D) y 45 (S/D)			
523172	29/08/2022	S (mixta)	9, 16, 35, 36, 38, 41 y 42	SAS INSTITUTE INC.	02/05/2021	201
523173	29/08/2022	CASH CONVERTERS	35, 36, 42, 43, 44 y 45	CASH CONVERTERS PTY LTD.	04/05/2021	201
523180	29/08/2022	ARTEPAN	30	ITACARÉ S.A.	27/04/2021	205
523181	29/08/2022	ARTIPAN	30	ITACARÉ S.A.	27/04/2021	205
523182	29/08/2022	ARTYPAN	30	ITACARÉ S.A.	27/04/2021	205
523184	29/08/2022	PAGNIFIQUE, EL NOMBRE DEL PAN	30 (S/D)	ITACARÉ S.A.	10/06/2021	205
523185	29/08/2022	PAGNIFIQUE (mixta)	30 y 43	ITACARÉ S.A.	28/06/2021	205
523189	29/08/2022	(figurativa)	25 y 28	ALPARGATAS SOCIEDAD ANONIMA INDUSTRIAL Y COMERCIAL	30/05/2021	165
523190	29/08/2022	ROADSTER	14 (S/D)	CARTIER INTERNATIONAL AG	22/07/2021	165
523191	29/08/2022	EL TRIGAL-COUNTRY	29 y 30	EL TRIGAL S.A.	12/06/2021	165
523194	29/08/2022	CEFACTAM	5	LABORATORIO LIBRA SOCIEDAD ANONIMA	25/04/2021	129
523195	29/08/2022	ATRACUR	5 (S/D)	LABORATORIO LIBRA SOCIEDAD ANONIMA	25/04/2021	129
523197	29/08/2022	RANDON TITANIUM	5	KÖNIG URUGUAY SOCIEDAD ANONIMA	28/04/2021	129
523199	29/08/2022	MAS	35 y 36	SUPERMERCADOS DISCO DEL	08/05/2021	165

N° Exp	Resolución	Denominación	Clases	Titular	Vigencia	Ag.
				URUGUAY S.A.		
523201	29/08/2022	A-B INBEV	32	Anheuser-Busch InBev S.A.	21/07/2021	144
523202	29/08/2022	STELLA	32 (S/D)	Anheuser-Busch InBev S.A.	19/09/2021	144
523203	30/08/2022	ASOCIACION CRISTIANA DE JOVENES	16, 25, 28, 35, 41, 43 y 45	ASOCIACION CRISTIANA DE JOVENES DE MONTEVIDEO	18/04/2021	201
523204	30/08/2022	CORONA EXTRA	32	CERVECERIA MODELO DE MEXICO S.de R.L. de C.V.	29/05/2021	144
523205	30/08/2022	DON ALEJO	30 y 43	DON ALEJO S.R.L.	20/06/2021	144
523207	30/08/2022	FAMILY CHANNEL (mixta)	38 y 41	INTERNATIONAL FAMILY ENTERTAINMENT, INC.	04/05/2021	144
523208	30/08/2022	DL (mixta)	16	KLIMA S.A.	27/09/2021	144
523209	30/08/2022	MUSTAD (mixta)	28	O. MUSTAD & SON A.S.	14/09/2021	144
523210	30/08/2022	OYSTER PROFESSIONAL	14 (S/D)	ROLEX SA	15/06/2021	144
523212	30/08/2022	AMBER ROMANCE	3 (S/D)	VICTORIA'S SECRET STORES BRAND MANAGEMENT, INC.	30/06/2021	144
523213	30/08/2022	DREAM ANGELS BY VICTORIA'S SECRET	3 (S/D)	VICTORIA'S SECRET STORES BRAND MANAGEMENT, INC.	30/06/2021	144
523214	30/08/2022	VICTORIA'S SECRET PURE SEDUCTION	3 (S/D)	VICTORIA'S SECRET STORES BRAND MANAGEMENT, INC.	30/06/2021	144
523216	30/08/2022	LOVE SPELL	3 (S/D)	VICTORIA'S SECRET STORES BRAND MANAGEMENT, INC.	30/06/2021	144
523219	30/08/2022	SALA VIP (mixta)	38 y 41	MONTE CABLEVIDEO S.A.	24/06/2021	144
523220	30/08/2022	URUGUAY (mixta)	33	ACEITERAS DEL URUGUAY Y CIDAC UNIDAS	25/06/2021	144
523222	30/08/2022	AUSTRALIAN	25 (S/D)	L'ALPINA MAGLIERIE SPORTIVE S.P.A.	27/05/2021	144
523229	30/08/2022	PUCCA (mixta)	25	VOOZ CO., LTD	20/12/2020	201
523231	30/08/2022	PUCCA (mixta)	3	VOOZ CO., LTD	19/05/2021	201
523233	30/08/2022	JUMPSTART	1 (S/D)	Novozymes A/S	02/05/2021	201
523235	30/08/2022	UNISYS (mixta)	7, 9, 11, 16, 20, 35 y 42	UNISYS CORPORATION	06/05/2021	194



N° Exp	Resolución	Denominación	Clases	Titular	Vigencia	Ag.
523236	30/08/2022	(figurativa)	29 (S/D) y 32 (S/D)	ALPINA PRODUCTOS ALIMENTICIOS S.A.	25/04/2021	94
523237	30/08/2022	SMARTFRESH	1 (S/D)	AGROFRESH INC.	16/05/2021	194
523238	30/08/2022	BICAMIDA	5	LABORATORIO GADOR S.A.	02/05/2021	165
523239	30/08/2022	ENTEROCIN	5	LABORATORIO GADOR S.A.	27/05/2021	165
523240	30/08/2022	MINILAX	5	LABORATORIO GADOR S.A.	07/06/2021	165
523241	30/08/2022	MEDOFENO	5	LABORATORIO GADOR S.A.	12/06/2021	165
523242	30/08/2022	SDLG (mixta)	7 (S/D), 12 (S/D) y 37 (S/D)	SHANDONG LINGONG CONSTRUCTION MACHINERY CO. LTD.	16/05/2021	194
523243	30/08/2022	REVIXIL	5	LABORATORIO GADOR S.A.	12/06/2021	165
523244	30/08/2022	IMUNOXA	5 (S/D)	LABORATORIO GADOR S.A.	12/06/2021	165
523245	30/08/2022	MEMORIPAK	5 y 20 (S/D)	LABORATORIO GADOR S.A.	30/06/2021	165
523246	30/08/2022	PIAGET (mixta)	18 (S/D)	RICHEMONT INTERNATIONAL S.A.	23/05/2021	194
523247	30/08/2022	PROMO CRUZADOS	38 y 41	FNC SOCIEDAD ANÓNIMA	17/06/2021	144
523248	30/08/2022	P (mixta)	14 (S/D)	RICHEMONT INTERNATIONAL S.A.	27/05/2021	194
523249	30/08/2022	PROMO EXTRA	38 y 41	FNC SOCIEDAD ANÓNIMA	17/06/2021	144
523250	30/08/2022	DULZOMETRO	38 y 41	FNC SOCIEDAD ANÓNIMA	17/06/2021	144
523251	30/08/2022	VIAJE EN PATOTA	38 y 41	FNC SOCIEDAD ANÓNIMA	17/06/2021	144
523252	30/08/2022	NATURINO (mixta)	25 (S/D)	FALC S.p.A.	23/05/2021	194
523253	30/08/2022	NORTEÑA	35, 36, 37, 38, 39, 40, 41 y 43	FNC S.A.	22/06/2021	144
523254	30/08/2022	BIER HAUS CERVEZA NORTEÑA	43	FNC S.A.	22/06/2021	144
523255	30/08/2022	ENTERTAINMENT PLUS (mixta)	9, 28, 31, 35, 36, 41, 42, 43 y 44	HRU S.A.	07/07/2021	144
523256	30/08/2022	I LIKE	30	MANTRA S.A.	09/05/2021	144
523257	30/08/2022	MOLINOS SAN JOSE S.A. (mixta)	30	MOLINOS SAN JOSE S.A.	24/05/2021	144
523258	30/08/2022	URUGUAY VOTA	38 y 41	MONTE CARLO T.V. S.A.	09/05/2021	144
523260	30/08/2022	LA ABUNDANCIA	35	SILCOM S.A.	27/06/2021	144

**RESOLUCIONES DE RENOVACIONES DE FRASES PUBLICITARIAS, CONCEDIDAS**

N° Exp	Resolución	Denominación	Clases	Titular	Vigencia	Ag.
494636	29/08/2022	ALLROAD	12 (S/D)	AUDI AG	14/05/2018	201
521049	11/08/2022	CEREZYME	5	GENZYME CORPORATION	24/05/2021	165

**RESOLUCIONES DE PETICIONES, MODELOS DE UTILIDAD**

N° Exp.	Resolución	Denominación	Clases	Titular	Dirección	Ag.
004769	03/08/2022	Marcelo Monzón Vaccarezza				

**TRANSFERENCIAS**

N° Exp.	Resolución	Denominación	Clases	Titular	Dirección	Ag.
376512	18/08/2022	KAMASA	6, 9 y 11	ZEHAI INTERNACIONAL LTDA.	MANZANA 6 GALPÓN 20 Z.FRANCA , IQUIQUE , CHILE	234
387202	22/07/2022	FLUCO 150	5	BALIARDA S.A.	COCHABAMBA 2525, C1252AAO, BUENOS AIRES, ARGENTINA	201
396939	11/08/2022	PARQUE DE LAS CIENCIAS	35	PARQUE DE LAS CIENCIAS S.A.	Ruta 101, km 23, 15000, COLONIA NICOLICH, CANELONES, URUGUAY	144
396940	11/08/2022	PARQUE DE LAS CIENCIAS	36	PARQUE DE LAS CIENCIAS S.A.	Ruta 101, km 23, 15000, COLONIA NICOLICH, URUGUAY	144
396941	11/08/2022	PARQUE DE LAS CIENCIAS	38	PARQUE DE LAS CIENCIAS S.A.	RUTA 101, Km 23, 15000, COLONIA NICOLICH, CANELONES, URUGUAY	144
396942	11/08/2022	PARQUE DE LAS CIENCIAS	39	PARQUE DE LAS CIENCIAS S.A.	RUTA 101 km 23, 15000, COLONIA NICOLICH, CANELONES, URUGUAY	144
396943	11/08/2022	PARQUE DE LAS CIENCIAS	42	PARQUE DE LAS CIENCIAS S.A.	Ruta 101 , km23, 15000, COLONIA NICOLICH,	144

N° Exp.	Resolución	Denominación	Clases	Titular	Dirección	Ag.
					CANELONES, URUGUAY	
396944	11/08/2022	PARQUE DE LAS CIENCIAS	44	PARQUE DE LAS CIENCIAS S.A.	Ruta 101 km 23 , 15000, COLONIA NICOLICH, CANELONES, URUGUAY	144
396951	11/08/2022	EL PARQUE	35	PARQUE DE LAS CIENCIAS S.A.	Ruta 101 , km 23, 15000, COLONIA NICOLICH, CANELONES, URUGUAY	144
398584	17/08/2022	MICRO REDS	1 y 3	Wella International Operations Switzerland Sàrl	CHEMIN LOUIS HUBERT 1 , 1213, PETIT LANCY, SUIZA	201
398584	18/08/2022	MICRO REDS	1 y 3	Wella International Operations Switzerland Sàrl	CHEMIN LOUIS HUBERT 1 , 1213, PETIT LANCY, SUIZA	201
398585	18/08/2022	LIGHT2COLOR	3	Wella International Operations Switzerland Sàrl	CHEMIN LOUIS HUBERT 1 , 1213, PETIT LANCY, SUIZA	201
398585	12/08/2022	LIGHT2COLOR	3	Wella International Operations Switzerland Sàrl	CHEMIN LOUIS HUBERT 1 , 1213, PETIT LANCY, SUIZA	201
402132	12/08/2022	PRO-VITAL DE KOLESTON	3	Wella International Operations Switzerland Sàrl	CHEMIN LOUIS HUBERT 1 , 1213, PETIT LANCY, SUIZA	201
402132	18/08/2022	PRO-VITAL DE KOLESTON	3	Wella International Operations Switzerland Sàrl	CHEMIN LOUIS HUBERT 1 , 1213, PETIT LANCY, SUIZA	201
403479	11/08/2022	ALFA NEURAL	5	NOVOPHAR S.A.	Plaza Independencias 831 of. 1201, MONTEVIDEO, URUGUAY	201
404334	10/08/2022	LA DOMÉNICA	35 y 43	Amalia Bibiana Paradiso Manente	Obligado 1377 apto. 104, Montevideo, URUGUAY	
404739	16/08/2022	INFUSIONS	3 y 44	Wella International Operations Switzerland Sàrl	CHEMIN LOUIS HUBERT 1 , 1213, PETIT LANCY, SUIZA	201
404739	18/08/2022	INFUSIONS	3 y 44	Wella International	CHEMIN LOUIS HUBERT 1 ,	201

N° Exp.	Resolución	Denominación	Clases	Titular	Dirección	Ag.
				Operations Switzerland Sàrl	1213, PETIT LANCY, SUIZA	
407563	09/08/2022	SEEN	9	GrandVision Group Holding B.V.	Evert van de Beekstraat 1 Ruimtenr. 80, Tower C, 6th Floor, 1118 CL, Schiphol, PAISES BAJOS	201
407566	09/08/2022	PLAY!	9	GrandVision Group Holding B.V.	Evert van de Beekstraat 1 Ruimtenr. 80, Tower C, 6th Floor, 1118 CL, Schiphol, PAISES BAJOS	201
410724	23/08/2022	CEGELEC	7, 9, 11 y 12	CEGELEC HOLDING (société par actions simplifiée)	10, avenue du Stade de France, 93200, Saint-Denis, FRANCIA	219
411742	02/08/2022	GAES	10	AMPLIFON IBÉRICA S.A	Avenida de Madrid, 199 bajos, 50017, Zaragoza, ESPAÑA	201
412345	08/08/2022	SMARTOFFICE PLAZA INDEPENDENCIA	36	Smart office SRL	Plaza Independencia 848, 1er. Piso, Montevideo, URUGUAY	201
412345	30/08/2022	SMARTOFFICE PLAZA INDEPENDENCIA	36	Smart office SRL	Plaza Independencia 848, 1er. Piso, Montevideo, URUGUAY	201
412817	18/08/2022	LIQUEFY	3	Wella International Operations Switzerland Sàrl	CHEMIN LOUIS HUBERT 1 , 1213, PETIT LANCY, SUIZA	201
412817	16/08/2022	LIQUEFY	3	Wella International Operations Switzerland Sàrl	CHEMIN LOUIS HUBERT 1 , 1213, PETIT LANCY, SUIZA	201
413750	01/08/2022	SUSHI POP	43	MOMENTOS UNICOS SRL	Marco Bruto N° 1144 "A", MONTEVIDEO, URUGUAY	201
414005	01/08/2022	ROCKLAND	25	ROCKLAND LTDA.	San José 1019, MONTEVIDEO, URUGUAY	245
414519	26/08/2022	XPANTION	42	TRANSFORMACIÓN DIGITAL S.A.S.	Julio César 1095 , Montevideo, URUGUAY	189
414555	04/08/2022	RISE	43	Hilton Worldwide Manage Limited	Maple Court Central Park, Reeds Crescent, WD24 4QQ, Watford, United Kingdom	194

N° Exp.	Resolución	Denominación	Clases	Titular	Dirección	Ag.
416330	11/08/2022	TUNDRA	5	NOVOPHAR S.A.	Plaza Independencia 831 oficina 1201, MONTEVIDEO, URUGUAY	201
416331	12/08/2022	TOSAFIN	5	NOVOPHAR S.A.	PLAZA INDEPENDENCIA 831 OF. 1201, ., MONTEVIDEO, MONTEVIDEO, URUGUAY	201
416333	12/08/2022	SULBUXIN	5	NOVOPHAR S.A.	PLAZA INDEPENDENCIA 831 OF. 1201, ., MONTEVIDEO, MONTEVIDEO, URUGUAY	201
416334	12/08/2022	SITAGLIP	5	NOVOPHAR S.A.	PLAZA INDEPENDENCIA 831 OF. 1201, ., MONTEVIDEO, MONTEVIDEO, URUGUAY	201
416335	12/08/2022	NOVOGREL	5	NOVOPHAR S.A.	PLAZA INDEPENDENCIA 831 OF. 1201, ., MONTEVIDEO, MONTEVIDEO, URUGUAY	201
416336	12/08/2022	MOLTRAZEN	5	NOVOPHAR S.A.	PLAZA INDEPENDENCIA 831 OF. 1201, ., MONTEVIDEO, MONTEVIDEO, URUGUAY	201
416337	12/08/2022	MENTHO-RHIN	5	NOVOPHAR S.A.	PLAZA INDEPENDENCIA 831 OF. 1201, ., MONTEVIDEO, MONTEVIDEO, URUGUAY	201
416338	12/08/2022	MECLIMINE	5	NOVOPHAR S.A.	PLAZA INDEPENDENCIA 831 OF. 1201, ., MONTEVIDEO, MONTEVIDEO, URUGUAY	201
416339	12/08/2022	MAXIVIT	5	NOVOPHAR S.A.	PLAZA INDEPENDENCIA 831 OF. 1201, ., MONTEVIDEO, MONTEVIDEO, URUGUAY	201
416340	12/08/2022	JOSAMINA	5	NOVOPHAR S.A.	PLAZA INDEPENDENCIA 831 OF. 1201, ., MONTEVIDEO, MONTEVIDEO, URUGUAY	201
416341	12/08/2022	HIDRORETIC	5	NOVOPHAR S.A.	PLAZA INDEPENDENCIA 831 OF. 1201, ., MONTEVIDEO, MONTEVIDEO, URUGUAY	201
416343	12/08/2022	DIABEFARM	5	NOVOPHAR S.A.	PLAZA INDEPENDENCIA 831	201

N° Exp.	Resolución	Denominación	Clases	Titular	Dirección	Ag.
					OF. 1201, ., MONTEVIDEO, MONTEVIDEO, URUGUAY	
416344	12/08/2022	DAXIPEN	5	NOVOPHAR S.A.	PLAZA INDEPENDENCIA 831 OF. 1201, ., MONTEVIDEO, MONTEVIDEO, URUGUAY	201
416346	12/08/2022	CENTICELLUS	5	NOVOPHAR S.A.	PLAZA INDEPENDENCIA 831 OF. 1201, ., MONTEVIDEO, MONTEVIDEO, URUGUAY	201
416348	12/08/2022	ANGITEN	5	NOVOPHAR S.A.	PLAZA INDEPENDENCIA 831 OF. 1201, ., MONTEVIDEO, MONTEVIDEO, URUGUAY	201
416349	12/08/2022	A 3 COMPUESTO	5	NOVOPHAR S.A.	PLAZA INDEPENDENCIA 831 OF. 1201, ., MONTEVIDEO, MONTEVIDEO, URUGUAY	201
416523	22/08/2022	VERALLIA	21 y 40	VERALLIA PACKAGING	Tour Carpe Diem, Esplanade Nord, Place des Corolles , 92400, Courbevoie, FRANCIA	245
416570	19/08/2022	FLAT BAN	3	Wella International Operations Switzerland Sàrl	CHEMIN LOUIS HUBERT 1 , 1213, PETIT LANCY, SUIZA	201
416570	16/08/2022	FLAT BAN	3	Wella International Operations Switzerland Sàrl	CHEMIN LOUIS HUBERT 1 , 1213, PETIT LANCY, SUIZA	201
416573	19/08/2022	DRAMATIZE	3	Wella International Operations Switzerland Sàrl	CHEMIN LOUIS HUBERT 1 , 1213, PETIT LANCY, SUIZA	201
416573	16/08/2022	DRAMATIZE	3	Wella International Operations Switzerland Sàrl	CHEMIN LOUIS HUBERT 1 , 1213, PETIT LANCY, SUIZA	201
416576	16/08/2022	DUAL EGO	3	Wella International Operations Switzerland Sàrl	CHEMIN LOUIS HUBERT 1 , 1213, PETIT LANCY, SUIZA	201
416576	19/08/2022	DUAL EGO	3	Wella International Operations Switzerland	CHEMIN LOUIS HUBERT 1 , 1213, PETIT LANCY, SUIZA	201

N° Exp.	Resolución	Denominación	Clases	Titular	Dirección	Ag.
				Sàrl		
416635	24/08/2022	TOBI	5	BGP Products Operations GmbH	24, TURMSTRASSE, TOWER 4, 6312, STEINHAUSEN, SUIZA	34
416955	11/08/2022	SCÜNCI	21 y 26	STMP, LLC	625 East Hyman Avenue, 81611, Aspen, Colorado, E. U. DE NORTEAMERICA	201
417254	02/08/2022	UNIKA	32	MIGUEL ÁNGEL PIÑEIRO MARIÑO	Br. José Batlle y Ordoñez 2189/701, Montevideo, URUGUAY	94
417598	30/08/2022	ALTIUS GROUP	36 y 37	Altius Uruguay Holding LLC	Plaza Independencia 848, Piso 1, Montevideo, URUGUAY	201
417598	08/08/2022	ALTIUS GROUP	36 y 37	Altius Uruguay Holding LLC	Plaza Independencia 848, Piso 1, Montevideo, URUGUAY	201
418969	26/08/2022	ZENPEP	5	Société des Produits Nestlé S.A.	1800 Vevey, VEVEY, SUIZA	212
421134	22/08/2022	COSTAN	11	EPTA S.P.A.	Via Mecenate 86, 20138, Milano, ITALIA	212
421273	04/08/2022	HOMEWOOD SUITES BY HILTON	43	Hilton Worldwide Manage Limited	Maple Court Central Park, Reeds Crescent, WD24 4QQ, Watford, United Kingdom	194
421274	04/08/2022	HOMEWOOD SUITES BY HILTON	43	Hilton Worldwide Manage Limited	Maple Court Central Park, Reed Crescent,, WD24 4QQ, Watford, United Kingdom	194
421275	01/08/2022	HOME2 SUITES BY HILTON	43	Hilton Worldwide Manage Limited	Maple Court Central Park, WD24 4QQ , Reeds Crescent, Watford , GRAN BRETAÑA (REINO UNIDO)	194
421337	05/08/2022	LEUSTATIN	5	ATNAHS PHARMA UK LIMITED	Suite 1, 3rd Floor 11-12, St. James's Square, SW1Y 4LB, London, United Kingdom	201
423387	19/08/2022	TRILLIANCE	3	Wella Operations US, LLC	4500 Park Granada, Suite 100, CA 91302, Calabasas, California, E. U. DE NORTEAMERICA	201

<b>N° Exp.</b>	<b>Resolución</b>	<b>Denominación</b>	<b>Clases</b>	<b>Titular</b>	<b>Dirección</b>	<b>Ag.</b>
423388	19/08/2022	SHINE CRAFTER	3	Wella Operations US, LLC	4500 Park Granada, Suite 100, CA 91302, Calabasas, California, E. U. DE NORTEAMERICA	201
424642	04/08/2022	THE LUXURY OF BEING YOURSELF	43	Hilton Worldwide Manage Limited	Maple Court Central Park, WD24 4QQ , Reeds Crescent, Watford , GRAN BRETAÑA (REINO UNIDO)	194
429390	19/08/2022	WHAT'S NEXT.	3 y 44	Wella Operations US, LLC	4500 Park Granada, Suite 100, CA 91302, Calabasas, California, E. U. DE NORTEAMERICA	201
430793	15/08/2022	TERINA	5	BALIARDA S.A.	Cochabamba 2525, C1252AAO, Buenos Aires, Capital Federal, ARGENTINA	201
431424	16/08/2022	MICROLIGHT	1 y 3	Wella International Operations Switzerland Sàrl	CHEMIN LOUIS HUBERT 1 , 1213, PETIT LANCY, SUIZA	201
431424	19/08/2022	MICROLIGHT	1 y 3	Wella International Operations Switzerland Sàrl	CHEMIN LOUIS HUBERT 1 , 1213, PETIT LANCY, SUIZA	201
432572	01/08/2022	COCINERO DESDE 1932	29, 30 y 32	MOLINOS RIO DE LA PLATA S.A.	AVENIDA PRESIDENTE MANUEL QUINTANA 192, PISO 1°, CIUDAD AUTÓNOMA DE BUENOS AIRES, ARGENTINA	34
432884	05/08/2022	SANITITE	17	Advanced Drainage Systems, Inc.	N° 4640 Trueman Boulevard , 43026 , Hillard, OH, E. U. DE NORTEAMERICA	136
432884	12/08/2022	SANITITE	17	Advanced Drainage Systems, Inc.	N° 4640 Trueman Boulevard , 43026 , Hillard, OH, E. U. DE NORTEAMERICA	136
433691	15/08/2022	ENDOCLAR	5	BALIARDA S.A.	COCHABAMBA 2525, C1252AAO, BUENOS AIRES, CAPITAL FEDERAL, ARGENTINA	201



N° Exp.	Resolución	Denominación	Clases	Titular	Dirección	Ag.
437747	16/08/2022	RICETEC	31, 35, 42 y 44	RiceTec, Inc.	1925 FM 2917, 77511, Alvin, TX, E. U. DE NORTEAMERICA	34
438484	23/08/2022	AZIPLUS	5	BALIARDA S.A.	COCHABAMBA 2525, C1252AAO, BUENOS AIRES, CAPITAL FEDERAL , ARGENTINA	201
438485	23/08/2022	ZITROMIL	5	BALIARDA S.A.	COCHABAMBA 2525, C1252AAO , BUENOS AIRES, CAPITAL FEDERAL , ARGENTINA	201
438495	19/08/2022	WELLA PROFESSIONALS ILLUMINA COLOR	3	Wella International Operations Switzerland Sàrl	CHEMIN LOUIS HUBERT 1 , 1213, PETIT LANCY, SUIZA	201
438495	17/08/2022	WELLA PROFESSIONALS ILLUMINA COLOR	3	Wella International Operations Switzerland Sàrl	CHEMIN LOUIS HUBERT 1 , 1213, PETIT LANCY, SUIZA	201
438512	23/08/2022	ALODOL	5	BALIARDA S.A.	COCHABAMBA 2525, C1252AAO, BUENOS AIRES, CAPITAL FEDERAL , ARGENTINA	201
438536	24/08/2022	EUMOTIL	5	BALIARDA S.A.	COCHABAMBA 2525, C1252AAO, BUENOS AIRES, CAPITAL FEDERAL , ARGENTINA	201
438537	24/08/2022	PAROXIL	5	BALIARDA S.A.	COCHABAMBA 2525, C1252AAO, BUENOS AIRES, CAPITAL FEDERAL , ARGENTINA	201
438538	24/08/2022	RALENTIL	5	BALIARDA S.A.	COCHABAMBA 2525, C1252AAO, BUENOS AIRES, CAPITAL FEDERAL , ARGENTINA	201
439303	16/08/2022	ECCO CL	29, 30 y 31	RiceTec, Inc.	1925 FM 2917, 77511, Alvin,	34

N° Exp.	Resolución	Denominación	Clases	Titular	Dirección	Ag.
					TX, E. U. DE NORTEAMERICA	
439568	19/08/2022	WELLA	3	Wella International Operations Switzerland Sàrl	CHEMIN LOUIS HUBERT 1 , 1213, PETIT LANCY, SUIZA	201
439568	17/08/2022	WELLA	3	Wella International Operations Switzerland Sàrl	CHEMIN LOUIS HUBERT 1 , 1213, PETIT LANCY, SUIZA	201
439979	08/08/2022	YOGA	9	Lenovo PC International Limited	23/F Lincoln House Taikoo Place 979 King´s Road, Quarry Bay, HONG KONG	194
439979	05/08/2022	YOGA	9	Lenovo PC International Limited	23/F Lincoln House Taikoo Place 979 King´s Road, Quarry Bay, HONG KONG	194
441703	17/08/2022	WELLA PROFESSIONALS COLOR.ID	1 y 44	Wella International Operations Switzerland Sàrl	CHEMIN LOUIS HUBERT 1 , 1213, PETIT LANCY, SUIZA	201
441703	19/08/2022	WELLA PROFESSIONALS COLOR.ID	1 y 44	Wella International Operations Switzerland Sàrl	CHEMIN LOUIS HUBERT 1 , 1213, PETIT LANCY, SUIZA	201
445998	17/08/2022	FREE LIGHTS	3	Wella International Operations Switzerland Sàrl	CHEMIN LOUIS HUBERT 1 , 1213, PETIT LANCY, SUIZA	201
445998	19/08/2022	FREE LIGHTS	3	Wella International Operations Switzerland Sàrl	CHEMIN LOUIS HUBERT 1 , 1213, PETIT LANCY, SUIZA	201
448058	16/08/2022	CELFX MATRIX TECHNOLOGY	34	COMPAÑIA INDUSTRIAL DE TABACOS MONTE PAZ S.A.	San Ramón 716, 11800, MONTEVIDEO, URUGUAY	34
448059	17/08/2022	CELFX	34	COMPAÑIA INDUSTRIAL DE TABACOS MONTE PAZ S.A.	San Ramón 716, 11800, MONTEVIDEO, E. U. DE NORTEAMERICA	34

<b>N° Exp.</b>	<b>Resolución</b>	<b>Denominación</b>	<b>Clases</b>	<b>Titular</b>	<b>Dirección</b>	<b>Ag.</b>
448107	01/08/2022	CLARITI	5 y 9	CooperVision International Limited	Delta Park, Concorde Way, Segensworth North, P015 5RL, Fareham , Hampshire, GRAN BRETAÑA (REINO UNIDO)	136
449736	17/08/2022	ACTIFUSE	1 y 3	Wella International Operations Switzerland Sàrl	CHEMIN LOUIS HUBERT 1 , 1213, PETIT LANCY, SUIZA	201
449736	19/08/2022	ACTIFUSE	1 y 3	Wella International Operations Switzerland Sàrl	CHEMIN LOUIS HUBERT 1 , 1213, PETIT LANCY, SUIZA	201
449976	04/08/2022	HOMWOOD SUITES	43	Hilton Worldwide Manage Limited	Maple Court Central Park, WD24 4QQ , Reeds Crescent, Watford , GRAN BRETAÑA (REINO UNIDO)	194
449977	01/08/2022	HAMPTON INN	43	Hilton Worldwide Manage Limited	Maple Court Central Park, WD24 4QQ , Reeds Crescent, Watford , GRAN BRETAÑA (REINO UNIDO)	194
449978	01/08/2022	HAMPTON INN	43	Hilton Worldwide Manage Limited	Maple Court Central Park, WD24 4QQ , Reeds Crescent, Watford , GRAN BRETAÑA (REINO UNIDO)	194
451625	01/08/2022	MEDISOFT	9	CooperVision International Limited	Delta Park, Concorde Way, Segensworth North, P015 5RL, Fareham , Hampshire, GRAN BRETAÑA (REINO UNIDO)	136
452514	01/08/2022	GARDEN INN	43	Hilton Worldwide Manage Limited	Maple Court Central Park, WD24 4QQ , Reeds Crescent, Watford , GRAN BRETAÑA (REINO UNIDO)	194
452515	01/08/2022	GARDEN INN	43	Hilton Worldwide Manage Limited	Maple Court Central Park, WD24 4QQ , Reeds Crescent, Watford , GRAN BRETAÑA (REINO UNIDO)	194

N° Exp.	Resolución	Denominación	Clases	Titular	Dirección	Ag.
452858	01/08/2022	MYDAY	9	CooperVision International Limited	Delta Park, Concorde Way, Segensworth North, P015 5RL, Fareham , Hampshire, GRAN BRETAÑA (REINO UNIDO)	136
457491	01/08/2022	COOPERVISION	9	CooperVision International Limited	Delta Park, Concorde Way, Segensworth North, P015 5RL, Fareham , Hampshire, GRAN BRETAÑA (REINO UNIDO)	136
460030	03/08/2022	PRIMOLUT NOR	5	Songbook B.V.	Kingsfordweg 151, 104GR, Amsterdam, PAISES BAJOS	194
460475	19/08/2022	WELLA	3	Wella International Operations Switzerland Sàrl	CHEMIN LOUIS HUBERT 1 , 1213, PETIT LANCY, SUIZA	201
460475	17/08/2022	WELLA	3	Wella International Operations Switzerland Sàrl	CHEMIN LOUIS HUBERT 1 , 1213, PETIT LANCY, SUIZA	201
462127	15/08/2022	URUMIX	1 y 19	PREMEZCLADOS URUGUAY S.A.	Ruta 101 km 27.250, BARROS BLANCOS, CANELONES, URUGUAY	201
463049	15/08/2022	PREMEZCLADOS URUGUAY	1 y 19	PREMEZCLADOS URUGUAY S.A.	RuTA 101 km 27.250, BARROS BLANCOS, CANELONES, URUGUAY	201
463220	15/08/2022	BEXEL	1 y 19	PREMEZCLADOS URUGUAY S.A.	RUTA 101 Km 27.250, BARROS BLANCOS, CANELONES, URUGUAY	201
463222	16/08/2022	ULTRAMIX	1 y 19	PREMEZCLADOS URUGUAY S.A.	Ruta 101 km 20250, BARROS BLANCOS, CANELONES, URUGUAY	201
463511	16/08/2022	TERMOCAL	1 y 19	PREMEZCLADOS URUGUAY S.A.	RUTA 101 Km 27.250, BARROS BLANCOS, CANELONES, URUGUAY	201
463512	16/08/2022	THERMOCAL	1 y 19	PREMEZCLADOS URUGUAY S.A.	RUTA 101 Km 27.250, BARROS BLANCOS, CANELONES, URUGUAY	201

N° Exp.	Resolución	Denominación	Clases	Titular	Dirección	Ag.
463782	24/08/2022		1, 6, 7, 9, 11, 12, 19, 35, 36, 37, 38, 39, 40, 41, 42 y 45	Suez International	Tour CB21 - 16, place de l'Iris, 92040, Paris, La Défense Cedex, FRANCIA	144
463876	26/08/2022	CHACO	25	Wolverine Outdoors, Inc.	9341 Courtland Drive N.E, 49351, Rockford, Michigan, E. U. DE NORTEAMERICA	194
464084	16/08/2022	PUSA	19	PREMEZCLADOS URUGUAY S.A.	RUTA 101 Km 27.250, BARROS BLANCOS, CANELONES, URUGUAY	201
464085	16/08/2022	PUSA	1	PREMEZCLADOS URUGUAY S.A.	RUTA 101 Km 27.250, BARROS BLANCOS, CANELONES, URUGUAY	201
464355	19/08/2022		3	Wella International Operations Switzerland Sàrl	CHEMIN LOUIS HUBERT 1 , 1213, PETIT LANCY, SUIZA	201
464355	18/08/2022		3	Wella International Operations Switzerland Sàrl	CHEMIN LOUIS HUBERT 1 , 1213, PETIT LANCY, SUIZA	201
464537	03/08/2022	WEDGWOOD	21	Fiskars UK Limited	Wedgwood Drive, Barlaston, ST12 9ER, Stoke-on-Trent, Staffordshire, GRAN BRETAÑA (REINO UNIDO)	179
465869	17/08/2022	CELFX MATRIX TECHNOLOGY	34	COMPAÑIA INDUSTRIAL DE TABACOS MONTE PAZ S.A.	San Ramón 716, 11800, MONTEVIDEO, URUGUAY	34
466142	18/08/2022	GALENIC	3	GALENIC COSMETICS LABORATORY	3 Rue du Colonel Moll, 75017, Paris, FRANCIA	192
466146	03/08/2022	ROYAL DOULTON	21	Fiskars UK Limited	Wedgwood Drive, Barlaston, ST12 9ER, Stoke-on-Trent, Staffordshire, GRAN BRETAÑA (REINO UNIDO)	179
466166	19/08/2022	FREESTYLE COLORS	41 y 44	Wella International Operations Switzerland	CHEMIN LOUIS HUBERT 1 , 1213, PETIT LANCY, SUIZA	201

N° Exp.	Resolución	Denominación	Clases	Titular	Dirección	Ag.
				Sàrl		
466166	18/08/2022	FREESTYLE COLORS	41 y 44	Wella International Operations Switzerland Sàrl	CHEMIN LOUIS HUBERT 1 , 1213, PETIT LANCY, SUIZA	201
466850	08/08/2022	BETULA	10 y 25	Birkenstock IP GmbH	Burg Ockenfels, 53545, Linz AM RHEIN, ALEMANIA	245
466850	28/07/2022	BETULA	10 y 25	Birkenstock IP GmbH	Burg Ockenfels, 53545, Linz AM RHEIN, ALEMANIA	245
467367	09/08/2022	AMURAI	3, 8, 22 y 26	Wella International Operations Switzerland Sàrl	chemin Louis-Hubert 1, 1213, Petit-Lancy, SUIZA	201
467367	05/08/2022	AMURAI	3, 8, 22 y 26	Wella International Operations Switzerland Sàrl	chemin Louis-Hubert 1, 1213, Petit-Lancy, SUIZA	201
468155	05/08/2022	KERATINT	3	Wella International Operations Switzerland Sàrl	chemin Louis-Hubert 1, 1213, Petit-Lancy, SUIZA	201
468155	09/08/2022	KERATINT	3	Wella International Operations Switzerland Sàrl	chemin Louis-Hubert 1, 1213, Petit-Lancy, SUIZA	201
468337	19/08/2022	SHAPER	3	Wella Operations US, LLC	4500 Park Granada, Suite 100, CA 91302, Calabasas, California, E. U. DE NORTEAMERICA	201
469135	11/08/2022	TRUCCO	3	Wella Operations US, LLC	4500 Park Granada Suite 100 , CA 91302 , Calabasas, E. U. DE NORTEAMERICA	201
469136	18/08/2022	LIQUID HAIR	3	Wella International Operations Switzerland Sàrl	CHEMIN LOUIS HUBERT 1 , 1213, PETIT LANCY, SUIZA	201
469136	19/08/2022	LIQUID HAIR	3	Wella International Operations Switzerland Sàrl	CHEMIN LOUIS HUBERT 1 , 1213, PETIT LANCY, SUIZA	201
469160	01/08/2022	AVAIRA VITALITY	9	CooperVision International Limited	Delta Park, Concorde Way, Segensworth North, P015 5RL,	136

N° Exp.	Resolución	Denominación	Clases	Titular	Dirección	Ag.
					Fareham , Hampshire, GRAN BRETAÑA (REINO UNIDO)	
469585	24/08/2022	SUEZ	1, 6, 7, 9, 11, 12, 19, 35, 36, 37, 38, 39, 40, 41, 42 y 45	Suez International	Tour CB21 - 16, place de l'Iris, 92040, Paris, La Défense Cedex, FRANCIA	144
473379	18/08/2022	CLINKKY \$	42	CLINKKYLAB S.R.L.	Francisco Vidal 678 apto 1001, Montevideo, URUGUAY	34
473735	26/08/2022	IVEND	9 y 42	CitiXsys Limited	2nd Floor, Palmerston House, Fernian Street, D02WD37, Dublin, IRLANDA	194
474510	03/08/2022	MICROGYNON	5	Songbook B.V.	Kingsfordweg 151, 104GR, Amsterdam, PAISES BAJOS	194
475223	15/08/2022	LAPRENE	1 y 17	Celanese International Corporation	222 W.las Colinas Blvd, Suite 900N , 75039, IRVING, TEXAS, E. U. DE NORTEAMERICA	34
475528	12/08/2022	WELLACOLOR	3	Wella International Operations Switzerland Sàrl	CHEMIN LOUIS HUBERT 1 , 1213, PETIT LANCY, SUIZA	201
475528	18/08/2022	WELLACOLOR	3	Wella International Operations Switzerland Sàrl	CHEMIN LOUIS HUBERT 1 , 1213, PETIT LANCY, SUIZA	201
476378	16/08/2022	PEGABLOK	1 y 19	PREMEZCLADOS URUGUAY S.A.	RUTA 101 Km 27.250, BARROS BLANCOS, CANELONES, URUGUAY	201
476590	03/08/2022	FEMIANE	5	Songbook B.V.	Kingsfordweg 151, 104GR, Amsterdam, PAISES BAJOS	194
476783	05/08/2022	BIOFINITY	9	CooperVision International Limited	Delta Park, Concorde Way, Segensworth North, P015 5RL, Farenham, Hampshire, GRAN BRETAÑA (REINO UNIDO)	136
477129	09/08/2022	PERFORM	3	Wella International Operations Switzerland Sàrl	chemin Louis-Hubert 1, 1213, Petit-Lancy, SUIZA	201

N° Exp.	Resolución	Denominación	Clases	Titular	Dirección	Ag.
477129	05/08/2022	PERFORM	3	Wella International Operations Switzerland Sàrl	chemin Louis-Hubert 1, 1213, Petit-Lancy, SUIZA	201
477440	18/08/2022	SINUS	26	Wella International Operations Switzerland Sàrl	CHEMIN LOUIS HUBERT 1 , 1213, PETIT LANCY, SUIZA	201
477440	17/08/2022	SINUS	26	Wella International Operations Switzerland Sàrl	CHEMIN LOUIS HUBERT 1 , 1213, PETIT LANCY, SUIZA	201
479497	03/08/2022	MINIGYNON	5	Songbook B.V.	Kingsfordweg 151, 104GR, Amsterdam, PAISES BAJOS	194
481083	04/08/2022	TAPESTRY	35, 36, 41, 43 y 44	Hilton Worldwide Manage Limited	Maple Court Central Park, WD24 4QQ , Reeds Crescent, Watford , GRAN BRETAÑA (REINO UNIDO)	194
481323	17/08/2022	DR. FORHAIR	3, 35 y 44	Hasys Co., Ltd	N.º 908, 908-1,2,3,4, 909, 909-1,2 Samwhan, Hipex Bldg. B, 230 Pangyoyeok-ro, Bundangu, Seongnam-si, Gyeonggi-do, COREA DEL SUR	94
483619	17/08/2022	FULLPAGE	5, 31 y 44	RiceTec, Inc.	1925 FM 2917, 77511, Alvin, TX, E. U. DE NORTEAMERICA	34
485211	17/08/2022	BOTTEGA VENETA	18 y 25	BOTTEGA VENETA S.R.L.	Localita Conti Matraverso 1, 36054, Montebello, Vicentino, ITALIA	34
485211	16/08/2022	BOTTEGA VENETA	18 y 25	BOTTEGA VENETA S.R.L.	Localita Conti Matraverso 1, 36054, Montebello, Vicentino, ITALIA	34
486000	05/08/2022	TRILUXIV	1 y 3	Wella International Operations Switzerland Sàrl	chemin Louis-Hubert 1, 1213, Petit-Lancy, SUIZA	201
486000	09/08/2022	TRILUXIV	1 y 3	Wella International Operations Switzerland	chemin Louis-Hubert 1, 1213, Petit-Lancy, SUIZA	201



N° Exp.	Resolución	Denominación	Clases	Titular	Dirección	Ag.
				Sàrl		
486247	17/08/2022	WELLA	3, 7, 8, 9, 11, 14 y 17	Wella International Operations Switzerland Sàrl	CHEMIN LOUIS HUBERT 1 , 1213, PETIT LANCY, SUIZA	201
486247	18/08/2022	WELLA	3, 7, 8, 9, 11, 14 y 17	Wella International Operations Switzerland Sàrl	CHEMIN LOUIS HUBERT 1 , 1213, PETIT LANCY, SUIZA	201
487972	08/08/2022	MORE ALTIUS	36 y 37	Altius Uruguay Holding LLC	Plaza Independencia 848, Piso 1, Montevideo, URUGUAY	201
487972	30/08/2022	MORE ALTIUS	36 y 37	Altius Uruguay Holding LLC	Plaza Independencia 848, Piso 1, Montevideo, URUGUAY	201
488685	17/08/2022	BILÚ CARRASCO	35, 36, 37 y 41	JOSEF PRESCHE; Shela LEVITIN SAFRA; Alexia LEVITIN SAFRA y Raphael LEVITIN SAFRA	Andes 1293/1003, Montevideo, Montevideo, URUGUAY; Avenida a la Playa 16, apto 10 Bilú Carrasco, Canelones, URUGUAY; Avenida a la Playa 16, apto 10 Bilú Carrasco, Canelones, URUGUAY y Avenida a la Playa 16, apto 10 Bilú Carrasco, Canelones, URUGUAY	201
488686	17/08/2022	BILU	35, 36, 37 y 41	JOSEF PRESCHEL; Shela LEVITIN SAFRA; Raphael LEVITIN SAFRA y Alexia LEVITIN SAFRA	Plaza Independencia 848, Piso 1, Montevideo, URUGUAY; Avenida a la Playa 16, apto 10 Bilú Carrasco, Canelones, URUGUAY; Avenida a la Playa 16, apto 10 Bilú Carrasco, Canelones, URUGUAY y Avenida a la Playa 16, apto 10 Bilú Carrasco, Canelones, URUGUAY	201
488710	11/08/2022	LITTLE ME	25	Mamiye IP Holdings LLC	1385 Broadway, 18th Floor, New York, New York, E. U. DE NORTEAMERICA	212

N° Exp.	Resolución	Denominación	Clases	Titular	Dirección	Ag.
488723	24/08/2022	IMEDEEN	3 y 5	GlaxoSmithKline Consumer Healthcare AB	SOLNA, 171 54, STOCKOLM, SUECIA	216
489064	19/08/2022	LAMINATES	3	Wella Operations US, LLC	4500 Park Granada, Suite 100, CA 91302, Calabasas, California, E. U. DE NORTEAMERICA	201
489399	01/08/2022	PROCLEAR	9	CooperVision International Limited	Delta Park, Concorde Way, Segensworth North, P015 5RL, Fareham , Hampshire, GRAN BRETAÑA (REINO UNIDO)	136
490341	05/08/2022	KAMASA	7 y 8	ZEHAI INTERNACIONAL LTDA.	Manzana 6 , Galpón 20 Z. Franca, IQUIQUE, CHILE	234
491478	18/08/2022	HDC SYSTEM	1 y 3	Wella International Operations Switzerland Sàrl	CHEMIN LOUIS HUBERT 1 , 1213, PETIT LANCY, SUIZA	201
491478	09/08/2022	HDC SYSTEM	1 y 3	Wella International Operations Switzerland Sàrl	CHEMIN LOUIS HUBERT 1 , 1213, PETIT LANCY, SUIZA	201
491479	05/08/2022	HDC MOLECULES	1 y 3	Wella International Operations Switzerland Sàrl	chemin Louis-Hubert 1, 1213, Petit-Lancy, SUIZA	201
491479	11/08/2022	HDC MOLECULES	1 y 3	Wella International Operations Switzerland Sàrl	chemin Louis-Hubert 1, 1213, Petit-Lancy, SUIZA	201
491480	05/08/2022	HDC ACTIVATOR	1 y 3	Wella International Operations Switzerland Sàrl	chemin Louis-Hubert 1, 1213, Petit-Lancy, SUIZA	201
491480	09/08/2022	HDC ACTIVATOR	1 y 3	Wella International Operations Switzerland Sàrl	chemin Louis-Hubert 1, 1213, Petit-Lancy, SUIZA	201
491882	23/08/2022	ELOGGIO	32 y 33	Alfredo Molinar	Ruta 5, Km 49.500 Paso Espinosa, Canelones, URUGUAY	101
491959	05/08/2022	BIEN CON LOURDES	38 y 41	MONTE CARLO TV	PARAGUAY 2253,	144

N° Exp.	Resolución	Denominación	Clases	Titular	Dirección	Ag.
				S.A. y MARÍA LOURDES FERRO	MONTEVIDEO, URUGUAY y ARGERICH 4524 Apto.2, Montevideo, URUGUAY	
492951	23/08/2022	JOYSON SAFETY SYSTEMS	9, 11 y 12	JOYSON AUTO SAFETY S.A.	33 rue du Puits Romain, LUXEMBURGO	34
493958	17/08/2022	MAX-ACE	5, 31 y 44	RiceTec, Inc.	1925 FM 2917, 77511 , Alvin, TX, E. U. DE NORTEAMERICA	34
495908	02/08/2022	PROPERATI	35	RESEM CLASSIFIED SPAIN, S.L.	Avenida Diagonal N° 601, Peatonal 9, BARCELONA, ESPAÑA	216
496046	17/08/2022	SMARTRICE	31	RiceTec, Inc.	1925 FM 2917, 77511 , Alvin, TX, E. U. DE NORTEAMERICA	34
496218	11/08/2022	PERFECT AUTOMOTIVE	12	GC PARTICIPAÇÕES IMPORTADORA E DISTRIBUIDORA DE PEÇAS AUTOMOTIVAS LTDA.	RUA CORONEL IRINEU DE CASTRO, 43, SALA 115, JARDIM ANÁLIA FRANCO, SP, SÃO PAULO , BRASIL	34
496223	11/08/2022	PERFECT AUTOMOTIVE	35	GC PARTICIPAÇÕES IMPORTADORA E DISTRIBUIDORA DE PEÇAS AUTOMOTIVAS LTDA.	RUA CORONEL IRINEU DE CASTRO, 43, SALA 115, JARDIM ANÁLIA FRANCO, SP, SÃO PAULO , BRASIL	34
496642	09/08/2022	WELLAPERM	3	Wella International Operations Switzerland Sàrl	chemin Louis-Hubert 1, 1213, Petit-Lancy, SUIZA	201
496642	05/08/2022	WELLAPERM	3	Wella International Operations Switzerland Sàrl	chemin Louis-Hubert 1, 1213, Petit-Lancy, SUIZA	201
498873	18/08/2022	COLOR PERFECT	3	Wella International Operations Switzerland Sàrl	CHEMIN LOUIS HUBERT 1 , 1213, PETIT LANCY, SUIZA	201
498873	17/08/2022	COLOR PERFECT	3	Wella International	CHEMIN LOUIS HUBERT 1 ,	201

N° Exp.	Resolución	Denominación	Clases	Titular	Dirección	Ag.
				Operations Switzerland Sàrl	1213, PETIT LANCY, SUIZA	
498952	04/08/2022	H	41, 43 y 44	Hilton Worldwide Manage Limited	Maple Court Central Park, WD24 4QQ , Reeds Crescent, Watford , GRAN BRETAÑA (REINO UNIDO)	194
500121	31/08/2022	PRIMOSISTON	5	Songbook B.V.	Kingsfordweg 151, 104GR, Amsterdam, PAISES BAJOS	194
500636	17/08/2022	MA/U STUDIO	20	De Padova S.r.l	Via Santa Cecilia 7, 20122, Milano, ITALIA	216
501195	05/08/2022	LEUSTAT	5	ATNAHS PHARMA UK LIMITED	Suite 1, 3rd Floor 11-12, St. James's Square, SW1Y 4LB, London, United Kingdom	201
504257	05/08/2022	PROVIRON	5	Songbook B.V.	Kingsfordweg 151, 104GR, Amsterdam, PAISES BAJOS	194
505036	17/08/2022	ALTIUS LIFE	19, 36 y 37	Shela LEVITIN SAFRA; Raphael LEVITIN SAFRA y Alexia LEVITIN SAFRA	Avenida a la Playa 16, apto 10 Bilú Carrasco, Canelones, URUGUAY; Avenida a la Playa 16, apto 10 Bilú Carrasco, Canelones, URUGUAY y Avenida a la Playa 16, apto 10 Bilú Carrasco, Canelones, URUGUAY	201
505158	01/08/2022	HYDRASOFT	9	CooperVision International Limited	Delta Park, Concorde Way, Segensworth North, P015 5RL, Fareham , Hampshire, GRAN BRETAÑA (REINO UNIDO)	136
505242	18/08/2022	KOLESTON	3	Wella International Operations Switzerland Sàrl	CHEMIN LOUIS HUBERT 1 , 1213, PETIT LANCY, SUIZA	201
505242	16/08/2022	KOLESTON	3	Wella International Operations Switzerland Sàrl	CHEMIN LOUIS HUBERT 1 , 1213, PETIT LANCY, SUIZA	201
505257	12/08/2022	BLONDOR	3, 8, 22 y 26	Wella International	CHEMIN LOUIS HUBERT 1 ,	201

N° Exp.	Resolución	Denominación	Clases	Titular	Dirección	Ag.
				Operations Switzerland Sàrl	1213, PETIT LANCY, SUIZA	
505257	18/08/2022	BLONDOR	3, 8, 22 y 26	Wella International Operations Switzerland Sàrl	CHEMIN LOUIS HUBERT 1 , 1213, PETIT LANCY, SUIZA	201
505328	11/08/2022	CHACO	14	Wolverine Outdoors, Inc.	9341 Courtland Drive N.E., Rockford, 49351, Michigan, E. U. DE NORTEAMERICA	194
505330	11/08/2022	CHACO	18	Wolverine Outdoors, Inc.	9341 Courtland Drive N.E., Rockford, 49351, Michigan, E. U. DE NORTEAMERICA	194
505597	18/08/2022	MORE ALTIUS	19	Altius Uruguay Holding LLC	Plaza Independencia 848, Piso 1, Montevideo, URUGUAY	201
505597	31/08/2022	MORE ALTIUS	19	Altius Uruguay Holding LLC	Plaza Independencia 848, Piso 1, Montevideo, URUGUAY	201
505819	18/08/2022	ALTIUS GROUP	9	Altius Uruguay Holding LLC	Plaza Independencia 848, Piso 1, Montevideo, URUGUAY	201
505852	18/08/2022	BILÚ RIVIERA	19	PRESCHEL, JOSEF; Shela LEVITIN SAFRA; Raphael LEVITIN SAFRA y Alexia LEVITIN SAFRA	Plaza Independencia 848 piso 1, MONTEVIDEO, MONTEVIDEO, MONTEVIDEO, URUGUAY; Avenida a la Playa 16, apto 10 Bilú Carrasco, Canelones, URUGUAY; Avenida a la Playa 16, apto 10 Bilú Carrasco, Canelones, URUGUAY y Avenida a la Playa 16, apto 10 Bilú Carrasco, Canelones, URUGUAY	201
505853	18/08/2022	BILÚ BIARRITZ	19	PRESCHEL, JOSEF; Shela LEVITIN SAFRA; Raphael LEVITIN SAFRA y Alexia LEVITIN SAFRA	Plaza Independencia 848 piso 1, MONTEVIDEO, MONTEVIDEO, MONTEVIDEO, URUGUAY; Avenida a la Playa 16, apto 10	201

N° Exp.	Resolución	Denominación	Clases	Titular	Dirección	Ag.
					Bilú Carrasco, Canelones, URUGUAY; Avenida a la Playa 16, apto 10 Bilú Carrasco, Canelones, URUGUAY y Avenida a la Playa 16, apto 10 Bilú Carrasco, Canelones, URUGUAY	
505855	18/08/2022	BILÚ CARRASCO	19	PRESCHEL, JOSEF; Raphael LEVITIN SAFRA; Shela LEVITIN SAFRA y Alexia LEVITIN SAFRA	Plaza Independencia 848 piso 1, MONTEVIDEO, MONTEVIDEO, MONTEVIDEO, URUGUAY; Avenida a la Playa 16, apto 10 Bilú Carrasco, Canelones, URUGUAY; Avenida a la Playa 16, apto 10 Bilú Carrasco, Canelones, URUGUAY y Avenida a la Playa 16, apto 10 Bilú Carrasco, Canelones, URUGUAY	201
505856	18/08/2022	BILÚ	19	PRESCHEL, JOSEF; Shela LEVITIN SAFRA; Raphael LEVITIN SAFRA y Alexia LEVITIN SAFRA	Plaza Independencia 848 piso 1, MONTEVIDEO, MONTEVIDEO, MONTEVIDEO, URUGUAY; Avenida a la Playa 16, apto 10 Bilú Carrasco, Canelones, URUGUAY; Avenida a la Playa 16, apto 10 Bilú Carrasco, Canelones, URUGUAY y Avenida a la Playa 16, apto 10 Bilú Carrasco, Canelones, URUGUAY	201
506221	26/08/2022	CHACO	25	Wolverine Outdoors, Inc.	9341 Courtland Drive N.E, 49351, Rockford, Michigan, E. U. DE NORTEAMERICA	194

N° Exp.	Resolución	Denominación	Clases	Titular	Dirección	Ag.
506731	04/08/2022	HILTON	43 y 44	Hilton Worldwide Manage Limited	Maple Court Central Park, WD24 4QQ, Reeds Crescent, Watford , GRAN BRETAÑA (REINO UNIDO)	194
507674	18/08/2022	WELLOXON	3	Wella International Operations Switzerland Sàrl	CHEMIN LOUIS HUBERT 1 , 1213, PETIT LANCY, SUIZA	201
507674	15/08/2022	WELLOXON	3	Wella International Operations Switzerland Sàrl	CHEMIN LOUIS HUBERT 1 , 1213, PETIT LANCY, SUIZA	201
507984	05/08/2022	BRILHEX	21	SCHWANKE INDUSTRIAL LTDA.	Oswaldo Cruz n° 55 B. Vieja, Blumenau, BRASIL	234
508587	23/08/2022	GOT TALENT URUGUAY	41	FremantleMedia Limited y Maidmetal Limited	1 STEPHEN STREET, London, W1T 1AL, -, -, GRAN BRETAÑA (REINO UNIDO) y 9-13 St. Andrew Street, EC4A 3AF, Londres, GRAN BRETAÑA (REINO UNIDO)	34
512101	16/08/2022	URUTEX	1 y 19	PREMEZCLADOS URUGUAY S.A.	RuTA 101 km 27.250, BARROS BLANCOS, CANELONES, URUGUAY	201
512102	16/08/2022	MICROTEX	1 y 19	PREMEZCLADOS URUGUAY S.A.	RUTA 101 Km 27.250, BARROS BLANCOS, CANELONES, URUGUAY	201
513034	04/08/2022	HILTON	3, 9 y 25	Hilton Worldwide Manage Limited	Maple Court Central Park, WD24 4QQ , Reeds Crescent, Watford , GRAN BRETAÑA (REINO UNIDO)	194
513476	19/08/2022	ECO MARKET	35	MISA VILLERO, Enrique Adrian	Joaquín Suárez 3030 unidad B, MONTEVIDEO, URUGUAY	245
514511	31/08/2022	ALTIUS	35 y 36	Altius Uruguay Holding LLC	Plaza Independencia 848, Piso 1, Montevideo, URUGUAY	201
514511	19/08/2022	ALTIUS	35 y 36	Altius Uruguay Holding LLC	Plaza Independencia 848, Piso 1, Montevideo, URUGUAY	201

N° Exp.	Resolución	Denominación	Clases	Titular	Dirección	Ag.
515800	16/08/2022	MEZCLA GAUCHITA	19	PREMEZCLADOS URUGUAY S.A.	RUTA 101 Km 27.250, BARROS BLANCOS, CANELONES, URUGUAY	201
516449	01/08/2022	MEDIFLEX	9	CooperVision International Limited	Delta Park, Concorde Way, Segensworth North, P015 5RL, Fareham , Hampshire, GRAN BRETAÑA (REINO UNIDO)	136
517436	16/08/2022	COLOUR TOUCH	3	Wella International Operations Switzerland Sàrl	CHEMIN LOUIS HUBERT 1, 1213, PETIT LANCY, SUIZA	201
517436	18/08/2022	COLOUR TOUCH	3	Wella International Operations Switzerland Sàrl	CHEMIN LOUIS HUBERT 1, 1213, PETIT LANCY, SUIZA	201
519711	19/08/2022	NIOXIN	3	Wella International Operations Switzerland Sàrl	CHEMIN LOUIS HUBERT 1 , 1213, PETIT LANCY, SUIZA	201
521951	18/08/2022	DIRECTV HD	9, 38 y 41	Vrio Corp.	One Rockefeller Plaza, NY 10020-2003, Nueva York, E. U. DE NORTEAMERICA	218
521954	18/08/2022	DIRECTV+HDDVR	9, 38 y 41	Vrio Corp.	One Rockefeller Plaza, 10020-2003, NUEVA YORK, NUEVA YORK, E. U. DE NORTEAMERICA	218
522504	18/08/2022	INTENSIVE THERAPY	3	Wella International Operations Switzerland Sàrl	CHEMIN LOUIS HUBERT 1 , 1213, PETIT LANCY, SUIZA	201
522515	22/08/2022	POP SECRET	31	SNYDER'S- LANCE, INC.	13515 Ballantyne Corporate Place, 28277, Charlotte, North Caroline, E. U. DE NORTEAMERICA	136
523486	12/08/2022	WELLA PROFESSIONALS	3, 41 y 44	Wella International Operations Switzerland Sàrl	CHEMIN LOUIS HUBERT 1 , 1213, PETIT LANCY, SUIZA	201
523486	18/08/2022	WELLA PROFESSIONALS	3, 41 y 44	Wella International	CHEMIN LOUIS HUBERT 1 ,	201



N° Exp.	Resolución	Denominación	Clases	Titular	Dirección	Ag.
				Operations Switzerland Sàrl	1213, PETIT LANCY, SUIZA	
525323	23/08/2022	KYNDRYL	9, 35, 37, 38, 41 y 42	Kyndryl, Inc.	One Vanderbilt Avenue, 15th Floor, 10017, New York, E. U. DE NORTEAMERICA	34
525324	23/08/2022	KYNDRYL	9, 35, 37, 38, 41 y 42	Kyndryl, Inc.	One Vanderbilt Avenue, 15th Floor, 10017, New York, E. U. DE NORTEAMERICA	34
528054	05/08/2022	CLIMENE	5	Songbook B.V.	Kingsfordweg 151, 104GR, Amsterdam, PAISES BAJOS	194
528617	19/08/2022	RICETEC	31	RiceTec, Inc.	1925 FM 2917, 77511, Alvin, TX, E. U. DE NORTEAMERICA	34
529418	09/08/2022	BC LA CAMPAGNOLA - EL ABC DE LA VIDA SANA	5, 29 y 30	ARCOR S.A.I.C.	Maipú 1210, Pisos 1° y 2°, Buenos Aires, ARGENTINA	154
531554	11/08/2022	MARQUIS	7	Ningbo Marquis Hi-Tech Co., Ltd.	No. 665 Hengshan West Road , Beilun, Ningbo, Zhejiang Province, CHINA	34
532518	05/08/2022	ANTISEPTOL CLOROXILENOL	5	AZUVEL S.R.L.	San Martín 3749 , -, MONTEVIDEO, MONTEVIDEO, URUGUAY	201
532792	05/08/2022	GYNERA	5	Songbook B.V.	Kingsfordweg 151, 104GR, Amsterdam, PAISES BAJOS	194
533787	23/08/2022	ALCAZAR	11 y 35	COMERCIAL COYAHUE SPA	Camino a Cunco por Hichahue, Cautin, CHILE	163
534542	19/08/2022	PEARL STYLER	3	Wella International Operations Switzerland Sàrl	CHEMIN LOUIS HUBERT 1 , 1213, PETIT LANCY, SUIZA	201
534542	18/08/2022	PEARL STYLER	3	Wella International Operations Switzerland Sàrl	CHEMIN LOUIS HUBERT 1 , 1213, PETIT LANCY, SUIZA	201
534543	18/08/2022	OCEAN SPRITZ	3	Wella International Operations Switzerland Sàrl	CHEMIN LOUIS HUBERT 1 , 1213, PETIT LANCY, SUIZA	201

N° Exp.	Resolución	Denominación	Clases	Titular	Dirección	Ag.
534543	16/08/2022	OCEAN SPRITZ	3	Wella International Operations Switzerland Sàrl	CHEMIN LOUIS HUBERT 1 , 1213, PETIT LANCY, SUIZA	201
534544	16/08/2022	TEXTURE TOUCH	3	Wella International Operations Switzerland Sàrl	CHEMIN LOUIS HUBERT 1 , 1213, PETIT LANCY, SUIZA	201
534544	18/08/2022	TEXTURE TOUCH	3	Wella International Operations Switzerland Sàrl	CHEMIN LOUIS HUBERT 1 , 1213, PETIT LANCY, SUIZA	201
535297	05/08/2022	TRIQUILAR	5	Songbook B.V.	Kingsfordweg 151, 104GR, Amsterdam, PAISES BAJOS	194
536303	05/08/2022	NEOGYNON	5	Songbook B.V.	Kingsfordweg 151, 104GR, Amsterdam, PAISES BAJOS	194

### ***TRANSFERENCIAS PARCIALES***

N° Exp.	Resolución	Denominación	Clases	Titular	Dirección	Ag.
439935	26/08/2022	SISTEMA TECNOHOUSE URUGUAY	36 y 37	SISTEMA DE VIVIENDAS TECNOHOGAR S.R.L. y OSVALDO CESAR FERNANDEZ	Marcos Ciani N° 3305, VENADO TUERTO, SANTA FÉ, ARGENTINA y Calle Publica N°4430, 2600, Venado Tuerto, Santa Fé, ARGENTINA	201
502462	12/08/2022	INDIA	25	GONZALO ADRIAN SUBERBIE ARRUA y LUIS MANUEL DUTRA HERNANDEZ	EJIDO 1169 AP 802, MONTEVIDEO, 11100, MONTEVIDEO, MONTEVIDEO, URUGUAY y ANDES 1547 Apto 301, MONTEVIDEO, URUGUAY	

### ***TRANSFERENCIAS DE FRASES PUBLICITARIAS***

N° Exp.	Resolución	Denominación	Clases	Titular	Dirección	Ag.
438661	23/08/2022	NINGUNO DE NOSOTROS ES TAN BUENO COMO	32 y 33	Alfredo Molinari	Ruta 5, Km 49.500 Paso Espinosa, Canelones,	101

N° Exp.	Resolución	Denominación	Clases	Titular	Dirección	Ag.
		TODOS NOSOTROS JUNTOS			URUGUAY	
499326	30/08/2022	MORE IS MORE	36	Altius Uruguay Holding LLC	Plaza Independencia 848, Piso 1, Montevideo, URUGUAY	201
499326	08/08/2022	MORE IS MORE	36	Altius Uruguay Holding LLC	Plaza Independencia 848, Piso 1, Montevideo, URUGUAY	201
502011	08/08/2022	MORE IS MORE	37	Altius Uruguay Holding LLC	Plaza Independencia 848, Piso 1, Montevideo, URUGUAY	201
502011	31/08/2022	MORE IS MORE	37	Altius Uruguay Holding LLC	Plaza Independencia 848, Piso 1, Montevideo, URUGUAY	201

### ***TRANSFERENCIAS DE PATENTES***

N° Exp.	Resolución	Titular	Dirección	Ag.
028932	19/08/2022	Boehringer Ingelheim Animal Health USA Inc.		94
031093	18/08/2022	Boehringer Ingelheim Animal Health USA Inc.		94
034617	19/08/2022	Boehringer Ingelheim Animal Health USA Inc.		94
034636	19/08/2022	Boehringer Ingelheim Animal Health USA Inc.		94
034695	18/08/2022	Boehringer Ingelheim Animal Health USA Inc.		94
035342	29/08/2022	Vrio Corp.		218
035453	19/08/2022	Vrio Corp.		218
035487	09/08/2022	Vrio Corp.		218
035810	19/08/2022	Boehringer Ingelheim Animal Health USA Inc.		94
036328	11/08/2022	BOEHRINGER INGELHEIM ANIMAL HEALTH USA INC.		221
036570	10/08/2022	Boehringer Ingelheim Animal Health USA Inc.		221
036610	10/08/2022	BOEHRINGER INGELHEIM ANIMAL HEALTH USA INC.		221
036683	10/08/2022	BOEHRINGER INGELHEIM ANIMAL HEALTH USA, INC		221
036860	10/08/2022	BOEHRINGER INGELHEIM ANIMAL HEALTH USA INC.		221
036995	10/08/2022	BOEHRINGER INGELHEIM ANIMAL HEALTH USA INC.		221
037050	11/08/2022	BOEHRINGER INGELHEIM ANIMAL HEALTH USA INC.		221
037137	11/08/2022	BOEHRINGER INGELHEIM ANIMAL HEALTH USA INC.		221
037187	11/08/2022	BOEHRINGER INGELHEIM ANIMAL HEALTH USA INC.		221
037196	11/08/2022	BOEHRINGER INGELHEIM ANIMAL HEALTH USA INC.		221
037665	11/08/2022	BOEHRINGER INGELHEIM ANIMAL HEALTH USA INC.		221

N° Exp.	Resolución	Titular	Dirección	Ag.
037780	11/08/2022	BOEHRINGER INGELHEIM ANIMAL HEALTH USA INC.		221
038507	16/08/2022	NATURALIA INGREDIENTS S.r.l.		34

### ***CAMBIOS DE NOMBRE***

N° Exp.	Resolución	Denominación	Clases	Titular	Dirección	Ag.
391239	05/08/2022	D´ADDARIO	15	D´Addario & Company Inc.	595 Smith Street, NY 11735, Farmingdale, E. U. DE NORTEAMERICA	194
397513	02/08/2022	UEM UNIVERSIDAD EUROPEA DE MADRID	41	UNIVERSIDAD EUROPEA DE MADRID, S.A.U.	Tajo S/N, Villaviciosa de Odón, Madrid, ESPAÑA	34
399397	18/08/2022	PANEX CITRUS	21	SEB DO BRASIL PRODUTOS DOMESTICOS LTDA.	Av. Arno, nº 146, parte Mooca , 031800-900, São Paulo, BRASIL	34
409720	08/08/2022	YOGURMOUSSE	29 y 30	Gloria Foods del URUGUAY S.A.	Camino Concordia s/n esquina con ruta 51 Nueva Helvecia , Colonia, URUGUAY	218
410724	01/08/2022	CEGELEC	7, 9, 11 y 12	CEGELEC HOLDING (société par actions simplifiée)	10, avenue du Stade de France, 93200, Saint-Denis, FRANCIA	219
413044	19/08/2022	AVES DEL SUR	33	VIÑA DEL PEDREGAL S.A.	Avda Francisco A. Encina 231, Villa Alegre de Loncomilla, CHILE	34
413045	19/08/2022	G7 THE 7TH GENERATION	33	VIÑA DEL PEDREGAL S.A.	Avda Francisco A. Encina 231, Villa Alegre de Loncomilla, CHILE	34
413401	04/08/2022	SEMILLAS LATITUD	31	SEMILLAS LATITUD S.A.	GENERAL NARIÑO 1907 , MONTEVIDEO, URUGUAY	201
413676	23/08/2022	FERRE FERIA	35	Cámara de Ferreterías, Pinturerías y Afines del Uruguay	Avenida del Libertador 1955/001, Montevideo, Montevideo, URUGUAY	194
413916	24/08/2022		12 y 37	BEIBEN TRUCKS GROUP CO., LTD.	East of No.1 Machinery Factory, Qingshan District, Baotou City,	34

N° Exp.	Resolución	Denominación	Clases	Titular	Dirección	Ag.
					Inner Mongolia Autonomous Region, CHINA	
413917	24/08/2022	BEI CHI	12 y 37	BEIBEN TRUCKS GROUP CO., LTD.	NO.9 BINGGONG EAST ROAD, EQUIPMENT MANUFACTURING, INDUSTRY PARK , BAOTOU CITY, INNER MONGOLIA AUTONOMOUS REGION, CHINA	34
413918	24/08/2022		12 y 37	BEIBEN TRUCKS GROUP CO., LTD.	NO.9 BINGGONG EAST ROAD, EQUIPMENT MANUFACTURING, INDUSTRY PARK , BAOTOU CITY, INNER MONGOLIA AUTONOMOUS REGION, CHINA	34
413919	24/08/2022		12 y 37	BEIBEN TRUCKS GROUP CO., LTD.	NO.9 BINGGONG EAST ROAD, EQUIPMENT MANUFACTURING, INDUSTRY PARK , BAOTOU CITY, INNER MONGOLIA AUTONOMOUS REGION, CHINA	213
413920	24/08/2022	BEI BEN	12 y 37	BEIBEN TRUCKS GROUP CO., LTD.	NO.9 BINGGONG EAST ROAD, EQUIPMENT MANUFACTURING INDUSTRY PARK , BAOTOU CITY, INNER MONGOLIA AUTONOMOUS REGION, CHINA	34
413921	24/08/2022		12 y 37	BEIBEN TRUCKS GROUP CO., LTD.	NO.9 BINGGONG EAST ROAD, EQUIPMENT MANUFACTURING INDUSTRY PARK , BAOTOU	34

N° Exp.	Resolución	Denominación	Clases	Titular	Dirección	Ag.
					CITY, INNER MONGOLIA AUTONOMOUS REGION, CHINA	
414318	02/08/2022	HINKELY	31, 35, 39, 42 y 44	SATUS AGER URUGUAY S.A.	Colonia 810, apto. 403, 11100, Montevideo, Montevideo, URUGUAY	94
416052	01/08/2022	LIMOL	3	Dreamco S.C.A	Parque Industrial OKS, Gral. Savio y A. Einstein (1619), Garín, Provincia de Buenos Aires, ARGENTINA	212
416523	05/08/2022	VERALLIA	21 y 40	VERALLIA PACKAGING	Tour Carpe Diem, Esplanade Nord, Place des Corolles , 92400, Courbevoie, FRANCIA	245
417408	05/08/2022	SKYY	32, 33 y 43	CAMPARI AMERICA LLC.	One Beach Street, suite 300, 94133, San Francisco, California, E. U. DE NORTEAMERICA	192
419448	02/08/2022	JET STAR SUPER	34	PT Sumatra Tobacco Trading Company	Jln. Pattimura N°3, Pematang Siantar, Sumatera Utara, INDONESIA	201
419702	16/08/2022	PERFICE	39	PERFICE S.A.	BOLIVIA 1330, MONTEVIDEO, URUGUAY	154
421446	08/08/2022	LECHE DESARROLLO	5 y 29	a Foods del URUGUAY S.A.	Camino Concordia s/n esquina con ruta 51 Nueva Helvecia , Colonia, URUGUAY	218
421526	02/08/2022	RANCONA	1 y 5	ARYSTA LIFESCIENCE INC.	15401 Weston Pakway Suite 150, 27513, Cary, NC, E. U. DE NORTEAMERICA	144
421938	01/08/2022	BONFIGLIOLI	7, 9 y 12	BONFIGLIOLI S.p.A.	Via Cav. Clementino Bonfiglioli 1 , 40012, Calderara Di Reno, BOLONIA, ITALIA	34
422697	23/08/2022	SALEWA	18, 25 y 28	Oberalp Deutschland GmbH.	Saturnstrasse 63, 85609, Aschheim, ALEMANIA	144
423342	15/08/2022	DIDELIN	12, 35 y 37	DIDELIN SOCIEDAD ANONIMA	Mercedes 1142, Montevideo, Montevideo, URUGUAY	

N° Exp.	Resolución	Denominación	Clases	Titular	Dirección	Ag.
423613	15/08/2022	NAO	21	LLADRO, S.A.	Ctra. Alboraya, s/n, Polígono Lladró, 46016, Tavernes Blanques, Valencia, ESPAÑA	34
430034	05/08/2022	BIRO	7	THE BIRO MANUFACTURING COMPANY	1114, West Main Street, Marblehead, Ohio, E. U. DE NORTEAMERICA	94
432884	11/08/2022	SANITITE	17	Advanced Drainage Systems, Inc.	N° 4640 Trueman Boulevard , 43026 , Hillard, OH, E. U. DE NORTEAMERICA	136
433931	23/08/2022	MERCK SHARP & DOHME	1, 5 y 16	Merck Sharp & Dohme LLC	One Merck Drive, Whitehouse Station, 08889-0100, New Jersey, E. U. DE NORTEAMERICA	192
436542	01/08/2022	GALLINA BLANCA	29 y 30	THE GB FOODS, SA	Plaza Europa, 42, 08902, L'Hospitalet de Llobregat, ESPAÑA	144
438332	11/08/2022	CROSSFIT MONTEVIDEO	41	CrossFit, LLC	2617 Broadway Boulder, 80304, Colorado, E. U. DE NORTEAMERICA	216
438621	22/08/2022	WEBER	7, 8 y 9	MARELLI EUROPE S.P.A.	Viale Aldo Borletti 61/63, 20011, Corbetta, Milano, ITALIA	34
438932	23/08/2022	CHRISTIAN DIOR	14	CHRISTIAN DIOR COUTURE	30 Avenue Montaigne, 75008, Paris, FRANCIA	144
438933	22/08/2022	BABY DIOR	24 y 25	CHRISTIAN DIOR COUTURE	30 Avenue Montaigne, 75008, Paris, FRANCIA	144
440925	24/08/2022	CARTA MAGNA	33	VIÑA DEL PEDREGAL S.A.	Avda. Francisco A. Encina 231, VILLA ALEGRE DE LONCOMILLA, CHILE	34
463782	23/08/2022		1, 6, 7, 9, 11, 12, 19, 35, 36, 37, 38, 39, 40, 41, 42 y 45	Suez International	Tour CB21 - 16, place de l'Iris, 92040, Paris, La Défense Cedex, FRANCIA	144
464537	05/08/2022	WEDGWOOD	21	Fiskars UK Limited	Wedgwood Drive, Barlaston, ST12 9ER, Stoke-on-Trent, Staffordshire, GRAN BRETAÑA (REINO UNIDO)	179

N° Exp.	Resolución	Denominación	Clases	Titular	Dirección	Ag.
464958	11/08/2022	CROSSFIT	41	CrossFit, LLC	1250 CONNECTICUT AVE, N.W. SUITE 200, WASHINGTON DC, E. U. DE NORTEAMERICA	216
466146	05/08/2022	ROYAL DOULTON	21	Fiskars UK Limited	Wedgwood Drive, Barlaston, ST12 9ER, Stoke-on-Trent, Staffordshire, GRAN BRETAÑA (REINO UNIDO)	179
466850	05/08/2022	BETULA	10 y 25	Birkenstock IP GmbH	Burg Ockenfels, 53545, Linz AM RHEIN, ALEMANIA	245
469585	23/08/2022	SUEZ	1, 6, 7, 9, 11, 12, 19, 35, 36, 37, 38, 39, 40, 41, 42 y 45	Suez International	Tour CB21 - 16, place de l'Iris, 92040, Paris, La Défense Cedex, FRANCIA	144
472428	04/08/2022	LA LLAVE DEL GOL	41	TFCF Latin American Channel LLC	10201 West Pico Boulevard, 90035, Los Angeles, California, E. U. DE NORTEAMERICA	18
472841	02/08/2022	SOLARIS	9	GrandVision France S.A.S.	1 rue Jean-Pierre Timbaud, 78180, Montigny Le Bretonneux , FRANCIA	192
475223	12/08/2022	LAPRENE	1 y 17	Celanese International Corporation	222 W.las Colinas Blvd, Suite 900N , 75039, IRVING, TEXAS, E. U. DE NORTEAMERICA	34
483456	03/08/2022	VIX	35, 41 y 42	Univision Digital IP Holdings, LLC	5599 Center Drive, Los Angeles, California, E. U. DE NORTEAMERICA	194
485824	04/08/2022	UTILISIMA SATELITAL	16	TFCF International Channels (US) Inc.	10201 West Pico Boulevard, 90035, Los Angeles, California, E. U. DE NORTEAMERICA	144
485826	04/08/2022	UTILISIMA SATELITAL	38	TFCF International Channels (US) Inc.	10201 West Pico Boulevard, 90035, Los Angeles, California, E. U. DE NORTEAMERICA	144
486860	02/08/2022	SERIOLA	4	TOTAL SE	2 Place Jean Millier, 92400, La Defense 6, Courbevoie,	201



N° Exp.	Resolución	Denominación	Clases	Titular	Dirección	Ag.
					FRANCIA	
487853	03/08/2022	VARGA	12	ZF AUTOMOTIVE BRASIL LTDA	Via Anhanguera Km, 147, Limeira, São Paulo, BRASIL	216
492951	22/08/2022	JOYSON SAFETY SYSTEMS	9, 11 y 12	JOYSON AUTO SAFETY S.A.	33 rue du Puits Romain, LUXEMBURGO	34
495882	23/08/2022	EKO-PACK	39	CHESTERTON MEXICANA, S.A. de C.V.	Av. Olmecas N° 1, Parque industrial Naucalpan, Naucalpan De Juarez, Naucalpan De Juarez, MEXICO	184
498798	03/08/2022	OREGON	7 y 8	Oregon Tool, Inc.	4909 SE International Way, 97222, Portland, Oregon, E. U. DE NORTEAMERICA	201
500019	05/08/2022	BALMAIN	26	Pierre Balmain S.A.S.	44 RUE FRANCOIS 1 ER., PARIS, 75008, PARIS, PARIS, FRANCIA	201
500020	05/08/2022	B	26	Pierre Balmain S.A.S.	44 RUE FRANCOIS 1 ER., PARIS, 75008, PARIS, PARIS, FRANCIA	201
500863	24/08/2022	MARTINAZZO	8	MARTINAZZO INDUSTRIA E COMERCIO LTDA.	RUA NATANO GIONGO N°410 BARRIO ALFANDEGA, RIO GRANDE DO SUL, 95720000, GARIBALDI, GARIBALDI, BRASIL	212
503509	11/08/2022	CROSSFIT	25	CrossFit, LLC	2617 Broadway Boulder, 80304, Colorado, E. U. DE NORTEAMERICA	216
509830	04/08/2022	WEBFLEET	9, 35, 36, 37, 38, 39 y 42	Bridgestone Mobility Solutions B.V	Beethovenstraat 503, 1083 HK, Amsterdam, Amsterdam, PAISES BAJOS	201
509832	04/08/2022	W	9, 35, 36, 37, 38, 39 y 42	Bridgestone Mobility Solutions B.V	Beethovenstraat 503, 1083 HK, Amsterdam, Amsterdam, PAISES BAJOS	201
510046	19/08/2022	MUNDO MAC	35	MUNDOMAC S.A.	Avda. Ing. Luis P. Ponce 1364, Montevideo, Montevideo,	245

N° Exp.	Resolución	Denominación	Clases	Titular	Dirección	Ag.
					URUGUAY	
515354	22/08/2022	MUNDOMAC STORE	35	MUNDOMAC S.A.	Ponce 1364, Montevideo, Montevideo, Montevideo, URUGUAY	245
520806	11/08/2022		29, 30, 31, 32 y 33	Foshan Haitian Flavouring & Food Co., Ltd.	No. 16, Wen Sha Road Foshan City, Guangdong Province, -, -, CHINA	144
522819	22/08/2022	SEA SERVICIO ECOAMBIENTE S.R.L.	5, 31, 35, 37, 39, 40 y 44	SERVICIO ECOAMBIENTE S.A.S.	Ruta 107 km 33.800, Canelones, Canelones, URUGUAY	94
528852	04/08/2022	ANTEAGROUP	42	ANTEA IBEROLATAM, S.L.U.	Glorieta de América 5 - 1º, -, 15004, A Coruña, A Coruña, ESPAÑA	216
530855	04/08/2022	EMBECTA	9, 10, 41, 42 y 44	Embecta Corp.	300 Kimball Drive, Parsippany, 07054, New Jersey, E. U. DE NORTEAMERICA	194
530859	04/08/2022	EMBECTA	9, 10, 41, 42 y 44	Embecta Corp.	300 Kimball Drive, Parsippany, 07054, New Jersey, E. U. DE NORTEAMERICA	194
532082	02/08/2022	MINERVA	32	MOLINOS RIO DE LA PLATA S.A.	ARGENTINA	34
535785	02/08/2022	MINERVA	2, 3, 4, 29, 30, 31 y 32	MOLINOS RIO DE LA PLATA S.A.	ARGENTINA	34

### ***CAMBIOS DE NOMBRE DE PATENTES***

N° Exp.	Resolución	Titular	Dirección	Ag.
034307	09/08/2022	Vrio Corp.		218
034567	09/08/2022	THE AT&T MVPD GROUP LLC		218
035062	22/08/2022	Corteva Agriscience LLC.		20
035222	22/08/2022	Corteva Agriscience LLC.		20
035224	22/08/2022	Corteva Agriscience LLC		211
035254	08/08/2022	CORTEVA AGRISCIENCE LLC		20
035255	16/08/2022	CORTEVA AGRISCIENCE LLC		20
035256	22/08/2022	Corteva Agriscience LLC		20

N° Exp.	Resolución	Titular	Dirección	Ag.
035342	09/08/2022	Vrio Corp.		218
035433	31/08/2022	Corteva Agriscience LLC		20
035453	09/08/2022	Vrio Corp.		218
035477	16/08/2022	CORTEVA AGRISCIENCE LLC		20
035825	17/08/2022	CORTEVA AGRISCIENCE LLC		20
035883	09/08/2022	THE AT&T MVPD GROUP LLC		218
035883	16/08/2022	THE AT&T MVPD GROUP LLC		218
035894	22/08/2022	Corteva Agriscience LLC.		20
037177	09/08/2022	ACIB GmbH; University of Natural Resources and Life Sciences, Vienna y Qualizyme Diagnostics GmbH & Co KG		216
038401	09/08/2022	TERVIVA, INC.		94
038904	09/08/2022	TERVIVA, INC.		94
039151	09/08/2022	TERVIVA, INC.		94
039152	09/08/2022	TERVIVA, INC.		94
039155	11/08/2022	TERVIVA, INC.		94

### ***CAMBIOS DE DOMICILIO***

N° Exp.	Resolución	Denominación	Clases	Titular	Dirección	Ag.
377090	02/08/2022	GYPROC	6	SAINT-GOBAIN CONSTRUCTION PRODUCTS UK LIMITED.	Saint-Gobain House, Binley Business Park, Coventry , CV3 2TT, United Kingdom	165
383408	02/08/2022	MANTRA	33	DELTA ESTE S.A.	Av. Córdoba 1728, 1°, C-1050 , CABA , ARGENTINA	144
386002	11/08/2022	CLINITEK ADVANTUS	10	SIEMENS HEALTHCARE DIAGNOSTICS INC.	1717 Deerfield Road, 60015, Deerfield, Illinois, E. U. DE NORTEAMERICA	219
392420	26/08/2022	NATURITAS	29, 30 y 32	SOLDO HNOS. S.A.	Bv. José Batlle y Ordóñez 6781, 12900, Montevideo, URUGUAY	245
394023	11/08/2022	WONPRO	9 y 11	SYLVIA MONICA KATZ	Benito Blanco 773 apto. 101, 11100, MONTEVIDEO, Montevideo, URUGUAY	
396206	15/08/2022	VISUCLAR	5	LABORATORIOS ELEA	Avenida Del Libertador 6550 3°	34

N° Exp.	Resolución	Denominación	Clases	Titular	Dirección	Ag.
				PHOENIX S.A.	Piso, Ciudad Autónoma de Buenos Aires, ARGENTINA	
399642	15/08/2022	RIO DE LA PLATA DUTY FREE	35	ANA ORO ZEINAL MENÉNDEZ	Plaza Independencia 822 oficina 301, Montevideo, URUGUAY	218
409720	09/08/2022	YOGURMOUSSE	29 y 30	Gloria Foods del URUGUAY S.A.	Camino Concordia s/n esquina con ruta 51 Nueva Helvecia , Colonia, URUGUAY	218
410182	22/08/2022		12	MACK TRUCKS,INC.	7900 National Services Road, 27409, Greensboro, North Carolina , E. U. DE NORTEAMERICA	144
410183	22/08/2022	MACK	12	MACK TRUCKS,INC.	7900 National Services Road, 27409, Greensboro, North Carolina , E. U. DE NORTEAMERICA	144
413401	11/08/2022	SEMILLAS LATITUD	31	SEMILLAS LATITUD S.A.	GENERAL NARIÑO 1907 , MONTEVIDEO, URUGUAY	201
413519	23/08/2022	DUCKBACK	21	IRLER S.A.	RAMBLA REPUBLICA DEL PERU 735/701 , Montevideo, URUGUAY	245
413756	01/09/2022	AYUÍ	36	PROEXUR S.R.L.	Tomas Gomensoro 2906, Montevideo, URUGUAY	216
413798	01/08/2022		32	STOKELY-VAN CAMP, INC.	700 ANDERSON HILL ROAD, 10577, PURCHASE, NEW YORK, E. U. DE NORTEAMERICA	201
413833	22/08/2022	JESUCRISTO ES EL SEÑOR IGLESIA UNIVERSAL DEL REINO DE DIOS	41	IGLESIA UNIVERSAL DEL REINO DE DIOS	Avda. 18 de Julio 2025, Montevideo, URUGUAY	201
413836	22/08/2022	PARE DE SUFRIR	16 y 38	IGLESIA UNIVERSAL DEL REINO DE DIOS	Avda. 18 de Julio 2025, Montevideo, URUGUAY	201
413839	22/08/2022	PALABRA DE VIDA	38	IGLESIA UNIVERSAL DEL REINO DE DIOS	Avda. 18 de Julio 2025, Montevideo, URUGUAY	201
413890	22/08/2022	MARY COHR	3 y 44	MARY COHR	120, avenue Charles de Gaulle,	216

N° Exp.	Resolución	Denominación	Clases	Titular	Dirección	Ag.
					92200, NEUILLY-SEINE, FRANCIA	
413917	29/08/2022	BEI CHI	12 y 37	BEIBEN TRUCKS GROUP CO., LTD.	NO.9 BINGGONG EAST ROAD, EQUIPMENT MANUFACTURING, INDUSTRY PARK , BAOTOU CITY, INNER MONGOLIA AUTONOMOUS REGION, CHINA	34
413918	29/08/2022		12 y 37	BEIBEN TRUCKS GROUP CO., LTD.	NO.9 BINGGONG EAST ROAD, EQUIPMENT MANUFACTURING, INDUSTRY PARK , BAOTOU CITY, INNER MONGOLIA AUTONOMOUS REGION, CHINA	34
413919	29/08/2022		12 y 37	BEIBEN TRUCKS GROUP CO., LTD.	NO.9 BINGGONG EAST ROAD, EQUIPMENT MANUFACTURING, INDUSTRY PARK , BAOTOU CITY, INNER MONGOLIA AUTONOMOUS REGION, CHINA	213
413920	29/08/2022	BEI BEN	12 y 37	BEIBEN TRUCKS GROUP CO., LTD.	NO.9 BINGGONG EAST ROAD, EQUIPMENT MANUFACTURING INDUSTRY PARK , BAOTOU CITY, INNER MONGOLIA AUTONOMOUS REGION, CHINA	34
413921	29/08/2022		12 y 37	BEIBEN TRUCKS GROUP CO., LTD.	NO.9 BINGGONG EAST ROAD, EQUIPMENT MANUFACTURING INDUSTRY PARK , BAOTOU	34

N° Exp.	Resolución	Denominación	Clases	Titular	Dirección	Ag.
					CITY, INNER MONGOLIA AUTONOMOUS REGION, CHINA	
414287	19/08/2022	LA ABUNDANCIA CIRUELAS PRESIDENT	29	SILCOM S.A.	Cordoba 731, Montevideo, URUGUAY	144
414672	15/08/2022	CERRO NEGRO	29	CIRO ALEJANDRO RODRIGUEZ HERNANDEZ	Ruta 45, Km 90, Departamento de San José, URUGUAY	
414810	24/08/2022	CRÈME YVETTE	33	LIGHTHORSE TRADEMARKS, LLC	The Alcott Cottage, Suite 250, 3827 West Chester Pike, Newtown Square, 19703, Pennsylvania , E. U. DE NORTEAMERICA	94
415114	22/08/2022	MUTOH	9	MUTOH HOLDINGS CO., LTD.	1-3, Ikejiri 3-chome Setagaya-ku, 154-0001, Tokyo, JAPON	216
416052	02/08/2022	LIMOL	3	Dreamco S.C.A	Parque Industrial OKS, Gral. Savio y A. Einstein (1619), Garín, Provincia de Buenos Aires, ARGENTINA	212
416301	02/08/2022		38 y 41	CWC COMMUNICATIONS LIMITED	Griffin House, 161 Hammersmith Road, W6 8BS, Londres, GRAN BRETAÑA (REINO UNIDO)	34
416523	11/08/2022	VERALLIA	21 y 40	VERALLIA PACKAGING	Tour Carpe Diem, Esplanade Nord, Place des Corolles , 92400, Courbevoie, FRANCIA	245
416613	22/08/2022	EDENRED	9, 16, 35, 36 y 43	EDENRED	14-16 Boulevard Garibaldi, 92130, ISSY- LESMOULINEAUX, FRANCIA	94
416944	12/08/2022	VZ BATH & BODY	3	VERONICA ZUBERBUHLER LANUSSE	José Ignacio Gorriti 4769-PB, C1414BJK, Ciudad Autónoma de Buenos Aires, ARGENTINA	94
417111	19/08/2022	LA MARTINA	3, 9, 14, 28 y 35	CAPINEL S.A.	Reconquista 517 p.5, Montevideo, URUGUAY	118

N° Exp.	Resolución	Denominación	Clases	Titular	Dirección	Ag.
417139	12/08/2022	CASA COR	16 y 41	CASA COR PROMOÇOES E COMERCIAL LTDA.	Avenida Piracema, n° 155, Mezanino, Tamboré Barueri, São Paulo, BRASIL	29
417139	17/08/2022	CASA COR	16 y 41	CASA COR PROMOÇOES E COMERCIAL LTDA.	Avenida Piracema, n° 155, Mezanino, Tamboré Barueri, São Paulo, BRASIL	29
417139	16/08/2022	CASA COR	16 y 41	CASA COR PROMOÇOES E COMERCIAL LTDA.	Avenida Piracema, n° 155, Mezanino, Tamboré Barueri, São Paulo, BRASIL	29
417140	16/08/2022	CASA COR	16 y 41	CASA COR PROMOÇOES E COMERCIAL LTDA.	Avenida Piracema, n° 155, Mezanino, Tamboré Barueri, São Paulo, BRASIL	29
417140	17/08/2022	CASA COR	16 y 41	CASA COR PROMOÇOES E COMERCIAL LTDA.	Avenida Piracema, n° 155, Mezanino, Tamboré Barueri, São Paulo, BRASIL	29
417140	12/08/2022	CASA COR	16 y 41	CASA COR PROMOÇOES E COMERCIAL LTDA.	Avenida Piracema, n° 155, Mezanino, Tamboré Barueri, São Paulo, BRASIL	29
417213	02/08/2022	MAGNOLIA	25	MAGNOLIA LTDA.	Carlos F. Saez N°6467, Montevideo, URUGUAY	118
417310	24/08/2022	SAN ROQUE SR	1, 3, 5, 9, 10 y 44	SAN ROQUE S.A.	CUAREIM 1844, MONTEVIDEO, URUGUAY	34
417405	02/08/2022	CANALI	14 y 18	CANALI IRELAND LIMITED	Suite 4.01, Ormond Building, 31- 36 Ormond Quay Upper, D07F6DC , Dublin 7, IRLANDA	247
417431	23/08/2022	STELLA D'ORO	29 y 30	STELLA D'ORO ALIMENTOS LTDA.	ESTRADA MUNICIPAL ITAPOLIS N°400, BAIRRO MONJOLINHO, BOA VISTA SÃO LOURENÇO, , ITAPOLIS, SÃO PAULO, BRASIL	34
417555	01/08/2022	BIOREND	1	BIOAGRO S.A.	Camino Loreto 2, Calera de Tango, SANTIAGO, CHILE	245
417717	10/08/2022		32	PLAYBOY ENTERPRISES	10960 Wilshire Boulevard Suite 2200, 90024, Los Angeles, CA,	201

N° Exp.	Resolución	Denominación	Clases	Titular	Dirección	Ag.
				INTERNATIONAL, INC.	E. U. DE NORTEAMERICA	
417772	05/08/2022	GRAFFIGNA	33	FINCA LA CELIA S.A.	AVENIDA SAN MARTÍN N° 972 PISO 3, MENDOZA, ARGENTINA	218
417905	04/08/2022	LHW THE LEADING HOTELS OF THE WORLD	16, 35 y 43	THE LEADING HOTELS OF THE WORLD LTD.	485 Lexington Avenue, 10017, New York, NY, E. U. DE NORTEAMERICA	144
417983	02/08/2022	HIMALAYA HERBALS	3	HIMALAYA GLOBAL HOLDINGS LTD.	Himalaya House, 138 Elgin Avenue, P.O BOX 1162, KY1 - 1102, Grand Cayman, ISLAS CAIMAN	144
418069	22/08/2022	OSTEOFOS	5	KÖNIG URUGUAY SOCIEDAD ANONIMA	García Lagos y Camino al Paso Hondo, Colonia Nicolich, Canelones, URUGUAY	129
418328	02/08/2022	INITIAL	37	RENTOKIL INITIAL 1927 PLC	Compass House, Manor Royal,, RH10 9PY, Crawley, West Sussex, GRAN BRETAÑA (REINO UNIDO)	221
418437	09/08/2022	DISPLAST	35, 40 y 42	DISPLAST S.A.	Aquiles Lanza 1123/25, MONTEVIDEO, URUGUAY	101
418474	24/08/2022	SRT	25	THE STRIDE RITE CORPORATION	500 Totten Pond Road , 02451, Waltham, Massachusetts, E. U. DE NORTEAMERICA	194
418476	24/08/2022	STRIDE RITE	25	THE STRIDE RITE CORPORATION	500 Totten Pond Road, Waltham, 02451, Waltham, Massachusetts, E. U. DE NORTEAMERICA	194
418483	23/08/2022	ILTERSIN	5	ZODIAC INTERNATIONAL CORPORATION	Calle 50, Edificio Global Plaza, 6to Piso, Panamá, PANAMA	245
418703	23/08/2022	BOSQUES DEL URUGUAY	36 y 44	AGRO EMPRESA FORESTAL S.A.	Juncal 1437 oficina 501, Montevideo, URUGUAY	218
418757	15/08/2022	V- KOOL	17	SOLUTIA SINGAPORE PTE.LTD.	9 North Buona Vista Drive, #05- 01, The Metropolis, 138588 ,	216



N° Exp.	Resolución	Denominación	Clases	Titular	Dirección	Ag.
					SINGAPUR	
418788	06/07/2022	SIL-ALL	31	Danstar Ferment AG	Poststrasse 30, 6300, Zug, SUIZA	192
419103	23/08/2022	HERTIZIC	5	ZODIAC INTERNATIONAL CORPORATION	Calle 50, Edificio Global Plaza, 6to Piso, Panamá, PANAMA	245
419275	01/08/2022	LIDL	35	LIDL STIFTUNG & CO. KG	Stiftsbergstrasse 1, 74172, Neckarsulm, ALEMANIA	144
419276	01/08/2022	LIDL	35	LIDL STIFTUNG & CO. KG	Stiftsbergstrasse 1, 74172, Neckarsulm, ALEMANIA	144
419716	22/08/2022	PARA'KITO	3 y 5	EVERGREEN LAND LIMITED	UNIT 3104-05, 31/F Universal Trade Centre 3 Arbutnot Road , Central Hong Kong, HONG KONG	179
419885	23/08/2022	ABCERTIN	5	ZODIAC INTERNATIONAL CORPORATION	Calle 50, Edificio Global Plaza, 6to Piso, Panamá, PANAMA	18
419981	23/08/2022	NN	36	NATIONALE- NEDERLANDEN NEDERLAND B.V.	Schenkkade 65 2595, AS DEN HAAG, PAISES BAJOS	194
419993	23/08/2022	LA CASA DEL WHOPPER	16, 29, 30, 32 y 43	BURGER KING CORPORATION	5707 Blue Lagoon Drive, 33126, Miami, Florida, E. U. DE NORTEAMERICA	136
420071	04/08/2022	AXENTRIA	35	GARINO HNOS. S.A.	Goes 2096, Montevideo, URUGUAY	181
420131	12/08/2022	CITROËN SELECT	12, 37 y 39	HFC Prestige International Operations Switzerland Sàrl	CHEMIN LOUIS HUBERT 1 - 3, 1213, PETIT LANCY, SUIZA	144
420144	23/08/2022	SEGURVIAJE	36, 43 y 44	MAPFRE ASISTENCIA, COMPAÑIA INTERNACIONAL DE SEGUROS Y REASEGUROS, S.A.	Carretera Pozuelo 52, Edificio 1 Anexo. Majadahonda , 28222, MADRID, ESPAÑA	245
420330	19/08/2022	BOPPY	20 y 24	THE BOPPY	350 Indiana Street Suite 800,	144

N° Exp.	Resolución	Denominación	Clases	Titular	Dirección	Ag.
				COMPANY L.L.C.	80401, Golden, Colorado, E. U. DE NORTEAMERICA	
421077	04/08/2022	RHODAPEX	1	RHODIA CHIMIE, UNA SOCIEDAD POR ACCIONES SIMPLIFICADAS	9 RUE DES CUIRASSIERS, IMMEUBLE SILEX 2 SOLVAY, 69003, LYON, FRANCIA	201
421165	04/08/2022	RHODAFAC	1	RHODIA CHIMIE, UNA SOCIEDAD POR ACCIONES SIMPLIFICADAS	9 RUE DES CUIRASSIERS, IMMEUBLE SILEX 2 SOLVAY, 69003, LYON, FRANCIA	201
421166	04/08/2022	RHODACAL	1	RHODIA CHIMIE, UNA SOCIEDAD POR ACCIONES SIMPLIFICADAS	9 RUE DES CUIRASSIERS, IMMEUBLE SILEX 2 SOLVAY, 69003, LYON, FRANCIA	201
421167	09/08/2022	BRICORR	1	RHODIA OPERATIONS	9 RUE DES CUIRASSIERS, IMMEUBLE SILEX 2 , SOLVAY, 69003, LYON, FRANCIA	187
421168	02/08/2022	SIPOMER	1	RHODIA OPERATIONS	9 RUE DES CUIRASSIERS, IMMEUBLE SILEX 2 SOLVAY, 69003, LYON, FRANCIA	201
421218	15/08/2022	GAVILON	35 y 36	THE GAVILON GROUP, LLC	1331 Capitol Avenue, 68102, OMAHA, NEBRASKA, E. U. DE NORTEAMERICA	201
421261	23/08/2022	ELS	41	ELS EDUCATIONAL SERVICES, INC.	7 ROSZEL ROAD, 08540, PRINCETON, NEW JERSEY, E. U. DE NORTEAMERICA	212
421262	24/08/2022	ELS	41	ELS EDUCATIONAL SERVICES, INC.	7 ROSZEL ROAD, 08540, PRINCETON, NEW JERSEY, E. U. DE NORTEAMERICA	212
421284	02/08/2022	IGEPAL	1	RHODIA OPERATIONS	9 RUE DES CUIRASSIERS, IMMEUBLE SILEX 2 SOLVAY, 69003, LYON, FRANCIA	201
421446	09/08/2022	LECHE DESARROLLO	5 y 29	a Foods del URUGUAY	Camino Concordia s/n esquina	218

N° Exp.	Resolución	Denominación	Clases	Titular	Dirección	Ag.
				S.A.	con ruta 51 Nueva Helvecia , Colonia, URUGUAY	
421526	08/08/2022	RANCONA	1 y 5	ARYSTA LIFESCIENCE INC.	15401 Weston Pakway Suite 150, 27513, Cary, NC, E. U. DE NORTEAMERICA	144
421594	18/08/2022	DIFFCORE	5	SMITHKLINE BEECHAM (CORK) LIMITED	12 Riverwalk, Citywest Business Campus, DUBLIN 24, IRLANDA	221
421938	11/08/2022	BONFIGLIOLI	7, 9 y 12	BONFIGLIOLI S.p.A.	Via Cav. Clementino Bonfiglioli 1 , 40012, Calderara Di Reno, BOLONIA, ITALIA	34
421938	09/08/2022	BONFIGLIOLI	7, 9 y 12	BONFIGLIOLI S.p.A.	Via Cav. Clementino Bonfiglioli 1 , 40012, Calderara Di Reno, BOLONIA, ITALIA	34
422594	09/08/2022	DYNASOL	1 y 17	DYNASOL ELASTOMEROS, S.A.U	C. Méndez Alvaro, 44., C.P. 28045, Madrid, ESPAÑA	144
422692	01/08/2022	MISTRAL	24	MISTRAL INTERNATIONAL BV	Bedrijvenstraat 2, 7641, AN WIERDEN, PAISES BAJOS	194
422724	01/08/2022	M MISTRAL ®	24	MISTRAL INTERNATIONAL BV	Bedrijvenstraat 2, 7641, AN WIERDEN, PAISES BAJOS	194
423672	12/08/2022	GQ BAR	43	ADVANCE MAGAZINE PUBLISHERS INC.	One World Trade Center, 10007, New York, N.Y., E. U. DE NORTEAMERICA	136
423673	12/08/2022	VOGUE CAFE	43	ADVANCE MAGAZINE PUBLISHERS INC.	One World Trade Center, 10007, New York, N.Y., E. U. DE NORTEAMERICA	136
423857	12/08/2022	REDPISO SERVICIOS INMOBILIARIOS	36	GRUPO INMOBILIARIO FINANCIERO REDPISO, S.A.	c/Eduardo Galeano n°228521 Rivas Vacia , Madrid, ESPAÑA	34
424064	02/08/2022	CWT	39 y 43	CW TRAVEL HOLDINGS, N.V.	Oval Tower, De Entree 159, 1101 HE, Amsterdam, PAISES BAJOS	247
425032	12/08/2022	EAU D'IKAR SISLEY	3	C.F.E.B. SISLEY	3 avenue du Friedland , 75008,	144

N° Exp.	Resolución	Denominación	Clases	Titular	Dirección	Ag.
					Paris, FRANCIA	
425628	15/08/2022	LOTUS	3, 8, 9, 16, 20, 21, 24, 25, 28, 34, 35, 37 y 41	GROUP LOTUS PLC	Hethel, NR14 8EZ, NORYHWICH, GRAN BRETAÑA (REINO UNIDO)	136
426200	15/08/2022	LOTUS	7 y 12	GROUP LOTUS PLC	Hethel, Northwich, NR14 9EZ, Norfolk, GRAN BRETAÑA (REINO UNIDO)	136
426223	12/08/2022	REGATA	14	FESTINA LOTUS, S.A.	Calle Velázquez 150, planta 3, puerta 1, 28002, Madrid, ESPAÑA	34
426286	12/08/2022	BRIONI	3 y 18	BRIONI S.P.A.	101, Piazza di San Bernardo,, 00187, Roma, ITALIA	201
427205	15/08/2022	URULEVA	30	LEDIFAR S.A	Besnes e Irigoyen 4740, Montevideo, Montevideo, URUGUAY	34
429746	16/08/2022	SIGNUM	1	RIZOBACTER ARGENTINA S.A.	Av. Dr. Arturo Frondizi N°1150, Parque Industrial Pergamino, PROVINCIA DE BUENOS AIRES, ARGENTINA	34
432675	01/08/2022	ING	36	ING GROEP N.V.	Bijlmerdreef 106, CT 1102, Amsterdam, PAISES BAJOS	194
432993	19/08/2022	TAXITRONIC	9	INTERFACOM, S.A.	Alejandro Sánchez 109, 28019, MADRID, ESPAÑA	220
433636	17/03/2022	7 UP	32	PORTFOLIO CONCENTRATE SOLUTIONS UNLIMITED COMPANY	5 Eastgate Road, Eastgate Business Park, Little Island, Co. Cork., IRLANDA	201
435938	24/08/2022	MITEL	37 y 38	MITEL NETWORKS CORPORATION	4000 Innovation Drive Kanata, K2K3K1, Ontario, CANADA	216
436291	11/08/2022	WIND STOPPER	24 y 25	W. L. GORE & ASSOCIATES, INC.	555 Paper Mill Road, 19711, Newark, Delaware, E. U. DE NORTEAMERICA	245
436542	09/08/2022	GALLINA BLANCA	29 y 30	THE GB FOODS, SA	Plaza Europa, 42, 08902,	144

N° Exp.	Resolución	Denominación	Clases	Titular	Dirección	Ag.
					L'Hospitalet de Llobregat, ESPAÑA	
437122	01/08/2022	LAUDER'S	33	MACDUFF & CO. LTD.	6 Newton Place, G3 7PR, Glasgow, GRAN BRETAÑA (REINO UNIDO)	144
437456	11/08/2022	TEVA	25	DECKERS OUTDOOR CORPORATION	250 Coromar Drive, 93117, Goleta, California, E. U. DE NORTEAMERICA	136
438009	16/08/2022	ICON	5	SYNGENTA LIMITED	Jealott's Hill International Research Centre, RG42 6EY, Bracknell, Berkshire , GRAN BRETAÑA (REINO UNIDO)	194
438010	16/08/2022	CALLISTO	5	SYNGENTA LIMITED	Jealott's Hill International Research Centre, RG42 6EY, Bracknell, Berkshire , GRAN BRETAÑA (REINO UNIDO)	194
438047	24/08/2022	CUENTATOTAL	36	SANTANDER INVESTMENT BANK LIMITED	Caves Corporate Centre, Building A, 1st Floor, West Bay Street & Blake Road, P.O. Box N-1682, Nassau, BAHAMAS	194
438050	23/08/2022	MONCUT	1 y 5	NIHON NOHYAKU CO. LTD.	19-8, Kyobashi 1-chome, Chuo- ku, Tokyo, JAPON	194
438198	24/08/2022	CELLOSIZE	1	UNION CARBIDE CORPORATION	7501 State Highway, 185 North Seadrift, TEXAS , E. U. DE NORTEAMERICA	216
438242	24/08/2022	MANN FILTER	12	MANN + HUMMEL GMBH	Schwieberdinger Strasse 126, 71636, Ludwigsburg, ALEMANIA	201
438288	26/08/2022	100% KLUTZ EN ESPAÑOL	16 y 28	KLUTZ	557 Broadway, 10012, New York, New York, E. U. DE NORTEAMERICA	194
438332	12/08/2022	CROSSFIT MONTEVIDEO	41	CrossFit, LLC	2617 Broadway Boulder, 80304, Colorado, E. U. DE NORTEAMERICA	216

N° Exp.	Resolución	Denominación	Clases	Titular	Dirección	Ag.
439031	01/08/2022	UNIVERSIDAD INTERNACIONAL S.E.K.	41	JORGE SEGOVIA BONET	CONDominio CASA COLONIA, FINCA FILIAL NUMERO SEIS, CURRIDABAT, SANCHEZ, PINARES SAN JOSE, COSTA RICA	201
439032	10/08/2022	COLEGIO INTERNACIONAL S.E.K.	41	JORGE SEGOVIA BONET	CONDominio CASA COLONIA, FINCA FILIAL NUMERO SEIS, CURRIDABAT, SANCHEZ, PINARES SAN JOSE, COSTA RICA	201
439660	26/08/2022	RIO DE LA PLATA FAMILIA DE BUEN SABOR	29 y 30	SOLDO HNOS. S.A.	Bv. José Batlle y Ordóñez 6781, 12900, Montevideo, URUGUAY	245
439737	02/08/2022	M M MORE THAN MANURE	1	VERDESIAN LIFE SCIENCES LLC	1001 Winstead Drive, Suite 480, Cary, 27513, NORTH CAROLINA, E. U. DE NORTEAMERICA	212
439935	24/08/2022	SISTEMA TECNOHOUSE URUGUAY	36 y 37	SISTEMA DE VIVIENDAS TECNOHOGAR S.R.L. y OSVALDO CESAR FERNANDEZ	Marcos Ciani N° 3305, VENADO TUERTO, SANTA FÉ, ARGENTINA y Calle Publica N°4430, 2600, Venado Tuerto, Santa Fé, ARGENTINA	201
440120	23/08/2022	AAIRPASS	39	AMERICAN AIRLINES, INC.	1 Skyview Drive MD 8B503, 76155, Fort Worth, Texas, E. U. DE NORTEAMERICA	136
442052	01/08/2022	PORTO SERVICIOS	35, 37, 38 y 45	PORTO SERVICIOS Y COMERCIO S.A.	Gregorio Suarez 2845, MONTEVIDEO, URUGUAY	94
442053	01/08/2022	PORTO SERVICIOS	35, 37, 38 y 45	PORTO SERVICIOS Y COMERCIO S.A.	Gregorio Suarez 2845, MONTEVIDEO, URUGUAY	94
442054	01/08/2022	PORTO SERVICIOS	35, 37, 38 y 45	PORTO SERVICIOS Y COMERCIO S.A.	Gregorio Suarez 2845, MONTEVIDEO, URUGUAY	94
442306	23/08/2022		39	AMERICAN AIRLINES, INC.	1 Skyview Drive MD 8B503, 76155, Fort Worth, Texas, E. U.	136

N° Exp.	Resolución	Denominación	Clases	Titular	Dirección	Ag.
					DE NORTEAMERICA	
442307	23/08/2022		35 y 39	AMERICAN AIRLINES, INC.	1 Skyview Drive MD 8B503, 76155, Fort Worth, Texas, E. U. DE NORTEAMERICA	136
446798	24/08/2022	PROLIANT	9	HEWLETT PACKARD ENTERPRISE DEVELOPMENT L.P.	1701 East Mossy Oaks Road, Spring, 77389, Texas, E. U. DE NORTEAMERICA	201
450418	02/08/2022	TUXEDO	1	VERDESIAN LIFE SCIENCES LLC	1001 Winstead Drive, Suite 480, Cary, 27513, NORTH CAROLINA, E. U. DE NORTEAMERICA	212
452352	24/08/2022	MANN FILTER	7 y 11	MANN + HUMMEL GMBH	Schwieberdinger Strasse 126, D-71636, Ludwigsburg, ALEMANIA	201
454443	05/08/2022	L LAFARGE	19 y 37	LAFARGE	14-16 Boulevard Garibaldi, 92130, ISSY LES MOULINEAUX, FRANCIA	192
454878	26/08/2022	THE PUMP	25	REEBOK INTERNATIONAL LIMITED	4th Floor, 11-12 Pall Mall, S21 Y SLU, London, GRAN BRETAÑA (REINO UNIDO)	201
461468	23/08/2022	AMERICAN AIRLINES	35, 37 y 39	AMERICAN AIRLINES, INC.	1 Skyview Drive MD 8B503, 76155, Fort Worth, Texas, E. U. DE NORTEAMERICA	136
465584	26/08/2022		9, 16, 35, 36, 37, 38, 41 y 42	HEWLETT PACKARD ENTERPRISE DEVELOPMENT LP	1701 East Mossy Oaks Road, 77389, Spring , Tx , E. U. DE NORTEAMERICA	201
466196	26/08/2022	ACCELERATING NEXT	9, 16, 35, 36, 37, 38, 41 y 42	HEWLETT PACKARD ENTERPRISE DEVELOPMENT LP	1701 East Mossy Oaks Road, 77389, Spring, TX , E. U. DE NORTEAMERICA	201
471806	23/08/2022	AMERICAN	35 y 39	American Airlines, Inc.	1 Skyview Drive, MD 8B503, 76155, Fort Worth, Texas, E. U. DE NORTEAMERICA	136
472360	26/08/2022		9, 35, 41 y 42	HEWLETT PACKARD ENTERPRISE	1701 East Mossy Oaks Road, 77389, Spring, TX, E. U. DE	201

N° Exp.	Resolución	Denominación	Clases	Titular	Dirección	Ag.
				DEVELOPMENT LP	NORTEAMERICA	
476783	01/08/2022	BIOFINITY	9	CooperVision International Limited	Delta Park, Concorde Way, Segensworth North, P015 5RL, Farenham, Hampshire, GRAN BRETAÑA (REINO UNIDO)	136
476888	24/08/2022	MANN FILTER	4, 7 y 12	MANN + HUMMEL GMBH	Schwieberdinger Strasse 126, 71636, Ludwigsburg, ALEMANIA	201
481908	08/08/2022	AUTODESK	9	AUTODESK, INC.	The Landmark @ One Market, 1 Market Street, Suite 400, 94105, San Francisco, CA, E. U. DE NORTEAMERICA	194
485824	11/08/2022	UTILISIMA SATELITAL	16	TFCF International Channels (US) Inc.	10201 West Pico Boulevard, 90035, Los Angeles, California, E. U. DE NORTEAMERICA	144
485826	11/08/2022	UTILISIMA SATELITAL	38	TFCF International Channels (US) Inc.	10201 West Pico Boulevard, 90035, Los Angeles, California, E. U. DE NORTEAMERICA	144
486855	24/08/2022	MANN FILTER	7 y 12	MANN + HUMMEL GMBH	Schwieberdinger Strasse 126, D-71636, Ludwigsburg, Ludwigsburg, ALEMANIA	201
487182	24/08/2022	MANN FILTER	7 y 12	MANN+HUMMEL GMBH	Schwieberdinger Strasse 126, D-71636, Ludwigsburg, ALEMANIA	201
487835	23/08/2022	AMERICAN AIRLINES	25, 28, 36, 38, 41 y 43	AMERICAN AIRLINES, INC.	1 Skyview Drive, MD 8B503, 76155, Fort Worth, Texas, E. U. DE NORTEAMERICA	136
487836	23/08/2022		25, 28, 35, 36, 38, 39, 41 y 43	AMERICAN AIRLINES, INC.	1 Skyview Drive, MD 8B503, 76155, Fort Worth, Texas, E. U. DE NORTEAMERICA	136
489649	01/08/2022	BIOMIN	31	DSM Austria Gmbh	Erber Campus 1, 3131, Getzersdorf bei Traismauer , AUSTRIA	181
489650	01/08/2022	MYCOFIX	31	DSM Austria Gmbh	Erber Campus 1, 3131,	201



N° Exp.	Resolución	Denominación	Clases	Titular	Dirección	Ag.
					Getzersdorf bei Traismauer , AUSTRIA	
497699	26/08/2022	SOUR PATCH KIDS	30	Mondelez Canada Inc.	277 Gladstone Avenue , M6J3L9, Toronto, Ontario, CANADA	18
498798	04/08/2022	OREGON	7 y 8	Oregon Tool, Inc.	4909 SE International Way, 97222, Portland, Oregon, E. U. DE NORTEAMERICA	201
502121	09/08/2022	BIOMEDICS	9	CooperVision International Holding Company, LP	Suite #2, Prestige House, Observatory Road., BB14006, St. Michael, BARBADOS	136
502753	23/08/2022	TWA	14	American Airlines, Inc.	1 Skyview Drive, MD 8B503, 76155, Fort Worth, Texas, E. U. DE NORTEAMERICA	136
502770	02/08/2022	BLUEFIT	41	BLUEFIT ACADEMIAS DE GINÁSTICA E PARTICIPAÇÕES S.A.	Rua Gomes de Carvalho, 1327, Conjunto 61 e 62, Vila Olimpia, CEP 04547-005, São Paulo, SP, BRASIL	34
503509	12/08/2022	CROSSFIT	25	CrossFit, LLC	2617 Broadway Boulder, 80304, Colorado, E. U. DE NORTEAMERICA	216
505162	23/08/2022	TWA	14	American Airlines, Inc.	1 Skyview Drive, MD 8B503, 76155, Fort Worth, Texas, E. U. DE NORTEAMERICA	136
509830	11/08/2022	WEBFLEET	9, 35, 36, 37, 38, 39 y 42	Bridgestone Mobility Solutions B.V	Beethovenstraat 503, 1083 HK, Amsterdam, Amsterdam, PAISES BAJOS	201
509832	11/08/2022	W	9, 35, 36, 37, 38, 39 y 42	Bridgestone Mobility Solutions B.V	Beethovenstraat 503, 1083 HK, Amsterdam, Amsterdam, PAISES BAJOS	201
512365	09/08/2022	XYZAL	5	GlaxoSmithkline Trading Services Limited	12 Riverwalk, Citywest Business Campus, DUBLIN 24, IRLANDA	218
518413	26/08/2022	SUPER DOME	9	HEWLETT PACKARD ENTERPRISE	1701 East Mossy Oaks Road, 77389, Spring, TX, E. U. DE	201

N° Exp.	Resolución	Denominación	Clases	Titular	Dirección	Ag.
				DEVELOPMENT LP	NORTEAMERICA	
519340	01/09/2022	ALTO DE LA BALLENA	33	DORILAR S.A.	RUTA 12 KM 16.400, Maldonado, URUGUAY	
519402	12/08/2022	FIGURELLA	5, 28 y 44	CLEIDE'S S.r.l.	Via Delle Industrie, 19, 30175, Venecia, ITALIA	144
524278	09/08/2022	AUTOCAD	9	AUTODESK, INC.	The Landmark @ One Market, 1 Market Street, Suite 400, 94105, San Francisco, CA, E. U. DE NORTEAMERICA	194
530855	05/08/2022	EMBECTA	9, 10, 41, 42 y 44	Embecta Corp.	300 Kimball Drive, Parsippany, 07054, New Jersey, E. U. DE NORTEAMERICA	194
530859	05/08/2022	EMBECTA	9, 10, 41, 42 y 44	Embecta Corp.	300 Kimball Drive, Parsippany, 07054, New Jersey, E. U. DE NORTEAMERICA	194
530966	23/08/2022	WAYRILZ	5	PRINCIPIA BIOPHARMA Inc.	55 Corporate Drive, Bridgewater, 08807, New Jersey, E. U. DE NORTEAMERICA	144
536465	02/08/2022	LUGARES	16	PUBLIREVISTAS S.A.	Zepita 3251, CIUDAD AUTONOMA DE BUENOS AIRES, ARGENTINA	94
538981	12/08/2022	BRIONI	25	BRIONI S.P.A.	101, Piazza di San Bernardo,, 00187, Roma, ITALIA	201
539774	11/08/2022	FANTUZZI	21	CANTRA S.L.	Albert Einstein, 18, Santander, ESPAÑA	34

### ***CAMBIOS DE DOMICILIO DE FRASES PUBLICITARIAS***

N° Exp.	Resolución	Denominación	Clases	Titular	Dirección	Ag.
412602	05/08/2022	EN... TODO RUEDA MEJOR	35 y 37	LARRIQUE RULEMANES S.A.	GALICIA 1204 , MONTEVIDEO, URUGUAY	34
454169	05/08/2022	BUILDING BETTER CITIES	19, 37, 40 y 42	LAFARGE	14-16 Boulevard Garibaldi, 92130, ISSY LES MOULINEAUX, FRANCIA	192

**REINSCRIPCIONES DE EMBARGOS**

N° Exp.	Resolución	Denominación	Clases	Titular	Dirección	Ag.
451773	08/08/2022	COYOTE	41	LEONARDO LARRIONDA	Hermanos Ruiz 3441, Montevideo, Montevideo, URUGUAY	186

**INSCRIPCIONES DE RENUNCIAS PARCIALES**

N° Exp.	Resolución	Denominación	Clases	Titular	Dirección	Ag.
440929	26/08/2022	ENSTO	7, 9 y 11	ENSTO OY (Business ID: 3155557-8)	Ensio Miettisen katu 2, 06100, Porvoo, FINLANDIA	201

**RESOLUCIONES DE RECURSOS, DNPI**

N° Exp	Resolución	Marca	Clases	Titular	Ag.
482794	10/08/2022	(figurativa) / KYB Corporation	12 (Concedida S/D)		34
503861	10/08/2022	23% PROTEINAS CARNES Y CEREALES MIX PERROS ADULTOS MORDIDA PEQUEÑA SABROSITOS TU MASCOTA SABE...PRODUCTO CON CALIDAD METRIVE (mixta) / METRIVE S.A.	31 (Concedida)		189

**RESOLUCIONES DE RECURSOS DE MODELOS DE UTILIDAD, DNPI**

N° Exp	Resolución	Marca	Clases	Titular	Ag.
004771	12/08/2022	/ Federico Villagrán			

**RESOLUCIONES DE PATENTES, CONCEDIDAS**

N° Exp	Resolución	Título	Titular	Ag.
No. 34476	15/08/2022	“MEZCLAS PESTICIDAS QUE INCLUYEN	SYNGENTA PATICIPATIONS AG	20

N° Exp	Resolución	Título	Titular	Ag.
		PIRROLIDINDIONAS ESPIROHETEROCÍCLICAS”.		
No. 34731	29/08/2022	“Polipéptidos recombinantes inhibidores de insectos contra especies del orden Hemiptera”	Monsanto Technology LLC	20
No. 34753	22/08/2022	MÉTODOS PARA PRODUCIR CLORHIDRATO DE ANAMORELINA QUE TIENE CONTENIDO CONTROLADO DE CLORURO	HELSINN HEALTHCARE SA y ONO PHARMACEUTICAL CO., LTD.	34
No. 34836	15/08/2022	Un Método no Biológico o Microbiológico para Producir una Planta Mejorada Mediante la Selección de Simbiota por medio del Cribado de Múltiples Asociaciones Huésped-Simbionte	AGRICULTURE VICTORIA SERVICES PTY LTD	18
No. 34930	15/08/2022	“COMPOSICIONES HERBICIDAS QUE COMPRENDEN ÁCIDO 4-AMINO-3-CLORO-5-FLUORO-6-(4-CLORO-2-FLUORO-3-METOXIFENIL)PIRIDINA-2-CARBOXÍLICO O UN DERIVADO DEL MISMO Y GLIFOSATO O GLUFOSINATO”.	DOW AGROSCIENCES LLC	211
No. 34974	22/08/2022	PIRIDAZINA 1,4 DISUSTITUIDA, ANÁLOGOS DE LA MISMA Y MÉTODOS PARA TRATAR LAS ENFERMEDADES RELACIONADAS CON DEFICIENCIA DEL SMN	NOVARTIS AG	94
No. 35008	22/08/2022	COMPOSICIONES Y MÉTODOS PARA MEJORAR LA COMPATIBILIDAD DE SALES HERBICIDAS HIDROSOLUBLES.	DOW AGROSCIENCES LLC	165
No. 35067	29/08/2022	COMPOSICIONES COLORANTES DE BAJO COV	Akzo Nobel Coatings International B.V.	212
No. 35161	15/08/2022	COMPOSICIÓN DE REMEDIACIÓN DE SUELOS	Injekta Environmental Pty Ltd	216
No. 35181	15/08/2022	PROCESO INTEGRADO PARA PRODUCCIÓN DE ÁCIDO 2,5-FURANDICARBOXILICO.	PETROLEO BRASILEIRO S.A. PETROBRAS	216
No. 35194	29/08/2022	COMPOSICIÓN HERBICIDA DE AMINOPIRALID Y CLOPIRALID Y MÉTODO PARA EL CONTROL SINÉRGICO DE VEGETACIÓN NO DESEADA	DOW AGROSCIENCES LLC	165

N° Exp	Resolución	Título	Titular	Ag.
No. 35203	29/08/2022	“MOLÉCULA DE ADN RECOMBINANTE CODIFICANTE DE ELEMENTOS REGULATORIOS DE PLANTAS Y CONSTRUCTOS, CÉLULAS VEGETALES Y PLANTAS Y MÉTODOS PARA OBTENERLAS”.	Monsanto Technology LLC	20
No. 35224	29/08/2022	“CONTROL DE MALEZAS A PARTIR DE APLICACIONES DE AMINOPIRALIDA, TRICLOPIR Y UN TENSIOACTIVO ORGANOSILICONADO”.	Corteva Agriscience LLC	211
No. 35237	22/08/2022	Composiciones que comprenden 2-[4-(4-clorofenoxi)-2-(trifluorometil)fenil]-1-(1,2,4-triazol-1-il)-propan-2-ol y un ingrediente activo adicional	BASF Agro B.V.	192
No. 35239	29/08/2022	UTILIZACIÓN DE AGUAS RESIDUALES Y GASES DE COMBUSTIÓN	UPM-Kymmene Corporation	94
No. 35311	22/08/2022	DIHIDROPIRIMIDINONAS BICÍCLICAS SUSTITUIDAS Y SU USO COMO INHIBIDORES DE LA ACTIVIDAD DE ELASTASA NEUTROFÍLICA	Boehringer Ingelheim International GmbH	192
No. 35336	29/08/2022	QUEMADOR-REACTOR DE VACÍO Y MEZCLA DE COMBUSTIBLES	Jorge DE LA SOVERA	94
No. 35394	22/08/2022	“PROCESOS PARA LA PREPARACIÓN DE 4-(4-{[2-(4-clorofenil)-4,4-dimetilciclohex-1-en-1-il]metil}piperazin-1-il)-N-({3-nitro-4-[(tetrahidro-2H-piran-4-ilmetil)amino]fenil}sulfonil)-2-(1H-pirrol[2,3-b]piridin-5-iloxi)benzamida y de 4-(4-{[2-(4-clorofenil)-4,4-dimetilciclohex-1-en-1-il]metil}piperazin-1-il)-N-({3-nitro-4-[(1R,4R)-[4-hidroxi-4-metilciclohexil]metil)amino]fenil}sulfonil)-2-(1H-pirrol[2,3-b]piridin-5-iloxi)benzamida COMO AGENTES INDUCTORES DE LA APOPTOSIS”	AbbVie Ireland Unlimited Company	218
No. 35398	22/08/2022	COMPUESTOS DE BIARILAMIDA COMO INHIBIDORES DE CINASA	NOVARTIS AG	94

<b>N° Exp</b>	<b>Resolución</b>	<b>Título</b>	<b>Titular</b>	<b>Ag.</b>
No. 35421	22/08/2022	COMPUESTO HETEROCÍCLICO CONDENSADO O SU SAL, INSECTICIDA AGRÍCOLA U HORTÍCOLA QUE COMPRENDE EL COMPUESTO	NIHON NOHYAKU CO., LTD.	94
No. 35455	15/08/2022	INHIBIDORES TRIPEPTIDICOS DE LA EPOXICETONA PROTEASA	Onyx Therapeutics, Inc.	136
No. 35487	29/08/2022	MÉTODO Y SISTEMA PARA UTILIZAR RECEPTORES CON PERFILES DE USUARIO	Vrio Corp.	218
No. 35518	22/08/2022	COMPOSICION DE HIDROCARBUROS RENOVABLE	UPM-KYMMENE CORPORATION	18
No. 35519	29/08/2022	COMPOSICION DE HIDROCARBUROS RENOVABLE	UPM-KYMMENE CORPORATION	18
No. 35564	29/08/2022	MÉTODO PARA ELABORAR CELULOSA NANOFIBRILAR Y PARA ELABORAR UN PRODUCTO DE PAPEL	UPM-Kymmene Corporation	94
No. 35621	29/08/2022	DISCO DIAGRAMA DIGITAL Y SU SISTEMA DE FUNCIONAMIENTO	DALTON ALEXANDRE DA SILVA	34
No. 39075	29/08/2022	MOLÉCULAS DE ADN REGULADORAS DE LA EXPRESIÓN GÉNICA DE PLANTAS; CONSTRUCCIONES, PLANTAS Y SUS PARTES, Y PRODUCTOS QUE LAS COMPRENDEN	MONSANTO TECHNOLOGY, LLC	211
No. 39076	29/08/2022	MOLÉCULAS DE ADN REGULADORAS DE LA EXPRESIÓN GÉNICA DE PLANTAS; CONSTRUCCIONES, PLANTAS Y SUS PARTES, Y PRODUCTOS QUE LAS COMPRENDEN	MONSANTO TECHNOLOGY, LLC	211
No. 39077	29/08/2022	MOLÉCULAS DE ADN REGULADORAS DE LA EXPRESIÓN GÉNICA DE PLANTAS; CONSTRUCCIONES, PLANTAS Y SUS PARTES, Y PRODUCTOS QUE LAS COMPRENDEN	MONSANTO TECHNOLOGY, LLC	211

### ***RESOLUCIONES DE DISEÑOS INDUSTRIALES, CONCEDIDAS***

<b>N° Exp</b>	<b>Resolución</b>	<b>Título</b>	<b>Titular</b>	<b>Ag.</b>
No. 4853	29/08/2022	TARJETA BANCARIA	DISA HOLDING ENERGÉTICO, S.L.U.	144

<b>N° Exp</b>	<b>Resolución</b>	<b>Título</b>	<b>Titular</b>	<b>Ag.</b>
No. 4857	29/08/2022	ESTUCHE PARA UN DISPOSITIVO ELECTRÓNICO	APPLE INC.	216
No. 4858	29/08/2022	ALTAVOZ	Apple Inc.	216
No. 4859	29/08/2022	CORREA	Apple Inc.	216
No. 4860	29/08/2022	CORREA	Apple Inc.	216
No. 4861	29/08/2022	AUDÍFONOS	Apple Inc.	216
No. 4862	29/08/2022	PARTES DE AUDÍFONOS	Apple Inc.	216
No. 4863	29/08/2022	BABERO	AH License ApS	181
No. 4864	29/08/2022	BOTELLA DE PERFUME	MONCLER S.P.A.	245
No. 4866	29/08/2022	CONTROLADOR PARA DISPOSITIVO ELECTRÓNICO	SONY INTERACTIVE ENTERTAINMENT INC.	201
No. 4867	29/08/2022	CONFIGURACIÓN APLICADA EN BARRIL	AMBEV S/A.	144
No. 4868	29/08/2022	BALDE CON TAPA	YPF S.A.	34
No. 4869	29/08/2022	ESTUCHE	APPLE INC.	216
No. 4870	29/08/2022	ESTUCHE CON AUDÍFONOS	APPLE INC.	216

### ***RESOLUCIONES DE MODELOS DE UTILIDAD, CONCEDIDAS***

<b>N° Exp</b>	<b>Resolución</b>	<b>Título</b>	<b>Titular</b>	<b>Ag.</b>
U-4792	22/08/2022	INSTRUMENTO PARA LA ESTIMACIÓN DE LA FUERZA EXPLOSIVA MUSCULAR	Universidad de la República	

### ***RESOLUCIONES DE PATENTES, DESESTIMADAS***

<b>N° Exp</b>	<b>Resolución</b>	<b>Título</b>	<b>Titular</b>	<b>Ag.</b>
No. 34751	15/08/2022	“COMPOSICIÓN DE PIENSO PARA REDUCIR LA METANOGENESIS EN RUMIANTES”	HEALTHTECH BIO ACTIVES, S.L.U.	192
No. 35268	22/08/2022	Composiciones Farmacéuticas que comprenden soluciones no acuosas de base lipídicas de 4-[7-(6-ciano-5-trifluorometilpiridin-3-il)-8-oxo-6-tioxo-5,7-diazaespiro [3.4]oct-5-il]-2-fluoro-N-metilbenzamida.	Aragon Pharmaceuticals, Inc.	192
No. 35506	29/08/2022	APARATO ELECTRONICO EMISOR DE ONDAS ELECTROMAGNETICAS PARA AHUYENTAR INSECTOS Y ANIMALES EN PLAGA	JAVIER IGNACIO VALLS	220

<b>N° Exp</b>	<b>Resolución</b>	<b>Título</b>	<b>Titular</b>	<b>Ag.</b>
No. 35528	29/08/2022	Moduladores del receptor de la progesterona para uso en la terapia de fibromas uterinos	PregLem SA	216
No. 38502	29/08/2022	MODIFICACIÓN DE BIOSÍNTESIS DE LIGNINA POR SUPRESIÓN CON SENTIDO	AGRICULTURE VICTORIA SERVICES PTY LTD y DAIRY AUSTRALIA LIMITED	34
No. 38572	15/08/2022	MÉTODO PARA EL MEJORAMIENTO DE LA CALIDAD DE LA MADERA Y SU RENDIMIENTO	SWETREE TECHNOLOGIES AB	165
No. 38712	29/08/2022	LACTAMAS FUSIONADAS DE ARILO Y HETEROARILO	Pfizer Inc.	211
No. 39280	29/08/2022	MÉTODOS Y COMPOSICIONES PARA PRODUCIR ARROZ RESISTENTE A INHIBIDORES DE ACCASA	RICETEC, INC.	211

### ***RESOLUCIONES DE DISEÑOS INDUSTRIALES, DESESTIMADAS***

<b>N° Exp</b>	<b>Resolución</b>	<b>Título</b>	<b>Titular</b>	<b>Ag.</b>
No. 4824	29/08/2022	CAJA VERSATIL PARA GUARDAR ALIMENTOS	LONGO MORGANTTI, GERARDO	
No. 4841	29/08/2022	ALIMENTO EN FORMA DE BARRA	CHELATO MONTEVIDEO S.R.L.	101

### ***RESOLUCIONES DE MODELOS DE UTILIDAD, DESESTIMADAS***

<b>N° Exp</b>	<b>Resolución</b>	<b>Título</b>	<b>Titular</b>	<b>Ag.</b>
U-4779	22/08/2022	PANEL ESTRUCTURAL MACIZO DE MULTIPLACA (PLYWOOD)	Federico Villagrán	
U-4790	29/08/2022	JABÓN-JABONERA DE SEGURIDAD POR CANAL DE INSERCIÓN MÚLTIPLE	Eduardo Medina Ylla	28

### ***RESOLUCIONES DE PATENTES, DESISTIDAS***

<b>N° Exp</b>	<b>Resolución</b>	<b>Título</b>	<b>Titular</b>	<b>Ag.</b>
No. 34469	15/08/2022	COMPOSICION HERBICIDA	FMC CORPORATION	18
No. 34546	15/08/2022	Compuestos útiles para combatir hongos fitopatogénicos que contienen una mutación en el gen mitocondrial citocromo b que confiere resistencia a los inhibidores de Qo en donde la	BASF SE	192



N° Exp	Resolución	Título	Titular	Ag.
		mutación es G143A, y composiciones agroquímicas.		

### ***RESOLUCIONES DE DISEÑOS INDUSTRIALES, DESISTIDAS***

N° Exp	Resolución	Título	Titular	Ag.
No. 4838	29/08/2022	PORTA TARJETAS	Apple Inc.	216

### ***RESOLUCIONES DE PATENTES, ABANDONADAS***

N° Exp	Resolución	Título	Titular	Ag.
No. 35330	15/08/2022	AMIDAS HETEROCÍCLICAS COMO INHIBIDORES DE CINASAS	GlaxoSmithKline Intellectual PropertyDevelopment Limited	18
No. 35401	22/08/2022	“COMPUESTOS AROMÁTICOS SUSTITUIDOS PARA EL TRATAMIENTO DE LA FIBROSIS PULMONAR, LA FIBROSIS HEPÁTICA, LA FIBROSIS DE LA PIEL Y LA FIBROSIS CARDÍACA”.	PROMETIC PHARMA SMT LIMITED.	144
No. 35402	22/08/2022	“COMPUESTOS AROMÁTICOS SUSTITUIDOS Y MÉTODO RELACIONADO PARA EL TRATAMIENTO DE LA FIBROSIS”.	PROMETIC PHARMA SMT LIMITED.	144
No. 35406	22/08/2022	AGENTES INDUCTORES DE LA APOPTOSIS PARA TRATAR EL CÁNCER Y ENFERMEDADES INMUNES Y AUTOINMUNES	AbbVie Inc.	218
No. 35437	29/08/2022	NUEVOS COMPUESTOS Y COMPOSICIONES FARMACÉUTICAS DE LOS MISMOS PARA EL TRATAMIENTO DE TRASTORNOS INFLAMATORIOS.	Galapagos NV	165
No. 35453	29/08/2022	MÉTODO Y SISTEMA PARA GRABAR CONTENIDOS RECOMENDADOS POR MEDIO DEL USO DE AGRUPADORES DE CONTENIDOS	Vrio Corp.	218
No. 35464	15/08/2022	INHIBIDORES COVALENTES DE KRAS G12C.	ARAXES PHARMA LLC	165
No. 38831	15/08/2022	Eco Hormigón Aligerado (con agregados de escamas,	Adrian Oborsky	

N° Exp	Resolución	Título	Titular	Ag.
		partículas y fibras PET) Celular.(EHAC-PET)		
No. 38832	15/08/2022	Eco Hormigón Aligerado (con escamas, partículas y fibras PET, y cáscaras de Arroz) con malla 3D	Adrian Oborsky	
No. 38834	15/08/2022	Eco Hormigón Aligerado con cáscaras de Arroz	Adrian Oborsky	
No. 38871	29/08/2022	Sistema de ajustes de nivel en la escalera	José Pedro Pérez Labandeira	
No. 39059	29/08/2022	Composición farmacéutica para controlar parásitos en organismos no humanos	Bayer Animal Health Gmbh	216
No. 39065	29/08/2022	COMPOSICIONES TERAPÉUTICAS, PRODUCTOS DE MANUFACTURA Y MÉTODOS PARA MEJORAR O PREVENIR LA INFECCIÓN	Centre for Digestive Diseases	211
No. 39292	29/08/2022	VARIANTES DE Fc SILENCIOSAS DE LOS ANTICUERPOS ANTI-CD40	NOVARTIS AG	211
No. 39413	29/08/2022	COMPUESTOS INHIBIDORES DE METALOENZIMAS	Mycovia Pharmaceuticals, Inc.	218

### ***RESOLUCIONES DE MODELOS DE UTILIDAD, ABANDONADAS***

N° Exp	Resolución	Título	Titular	Ag.
U-4797	15/08/2022	MODULO PARA EVASIÓN DE OBSTÁCULOS INTEGRADO A BASTÓN DE INVIDENTES	Fernando Sander	
U-4798	22/08/2022	PORTAMATE-MATERA ENVOLVENTE	Enrique Javier Ros Gadea	
U-4801	15/08/2022	Distanciador Social para espacios libres	Miguel Rosas	

En virtud de la discrepancia que surge en la actualidad entre la fecha de validez de las resoluciones en los sistemas IPAS y [PAMP](#) con la que surge del Boletín de la DNPI, debe dejarse constancia que la fecha de validez de la resolución correspondiente es la que surge de los sistema IPAS y [PAMP](#), fecha de firma de la misma.

## **NOTIFICACIONES DE ASESORÍA**

De conformidad con lo establecido por el numeral 4° del artículo 80 de la Ley 17.011 del 25 de setiembre de 1998 y artículo 87 del decreto N° 34/999 del 3 de febrero de 1999, se notifica a quien se cita a continuación, por razones de su interés, debe presentarse en sección Recursos de la Dirección Nacional de Propiedad Industrial, sita en la calle Rincón 723, 3er. Piso.

<b>MARCA</b>	<b>PÁJAROS PINTADOS CORREDOR TURÍSTICO DEL RÍO URUGUAY</b>
<b>ACTA</b>	475704
<b>NOMBRE</b>	MINISTERIO DE TURISMO
<b>NOTIFICACION</b>	<p><b>VISTO:</b> La solicitud de Registro de la Marca <i>PÁJAROS PINTADOS CORREDOR TURÍSTICO DEL RÍO URUGUAY (mixta)</i>, presentada bajo expediente No. <i>475704</i> a favor de <i>MINISTERIO DE TURISMO de URUGUAY</i>, para distinguir los servicios comprendidos en las Clases internacionales <i>35, 36, 38, 41 y 43</i>.</p> <p><b>RESULTANDO:</b> I) Contra dicha solicitud se dedujo oposición <b>CESAR PISANO E HIJOS S.A.</b></p> <p>II) División Legal dictamina que correspondería <b>CONCEDER</b> el presente registro por los argumentos que expone en su dictamen.</p> <p>III) El Encargado de Área Asuntos Jurídicos comparte lo dictaminado por su Asesor actuante.</p> <p><b>CONSIDERANDO:</b> que esta Dirección, de conformidad con lo dictaminado por su División Legal, resolverá en consecuencia.</p> <p><b>ATENCIÓN:</b> a lo expuesto, a lo que establecen la Ley de Marcas No 17.011 de 25 de setiembre de 1998, su Decreto Reglamentario No. 34/999 de 3 de febrero de 1999 y disposiciones modificativas.</p> <p style="text-align: center;"><b>LA DIRECCION NACIONAL DE LA PROPIEDAD INDUSTRIAL</b></p> <p style="text-align: center;"><b>RESUELVE:</b></p> <p><b>1°.- CONCÉDESE</b> el Registro de la Marca <i>PÁJAROS PINTADOS CORREDOR TURÍSTICO DEL RÍO URUGUAY (mixta)</i>, por el conjunto, sin derechos privativos sobre los términos "CORREDOR" y "TURÍSTICO", artículo 7 de la ley 17.011, y con el alcance previsto por el artículo 74 de la ley 17.011 sobre "RIO URUGUAY", solicitado bajo expediente No. <i>475704</i> a favor de <i>MINISTERIO DE TURISMO de URUGUAY</i>, para distinguir los servicios comprendidos en las Clases internacionales <i>35, 36, 38, 41 y 43</i>. Página 2 de 2</p> <p><b>2°.- NOTIFÍQUESE</b>, publíquese, efectúense las anotaciones de estilo, entréguese el título bajo recibo y oportunamente archívese.</p>

<b>MARCA</b>	<b>COMPRALO YA</b>
<b>ACTA</b>	489072
<b>NOMBRE</b>	EDALSIR SOCIEDAD ANONIMA
<b>NOTIFICACION</b>	<p><b>VISTO:</b> La solicitud de Registro de la Marca <b>COMPRALO YA (denominativa)</b>, presentada bajo expediente No. <b>489072</b> a favor de <b>EDALSIR SOCIEDAD ANONIMA de URUGUAY</b>, para distinguir los servicios comprendidos en las Clases internacionales <b>35 y 38</b>.</p> <p><b>RESULTANDO:</b> I) Contra dicha solicitud se dedujo oposición de terceros.</p> <p>II) División Legal dictamina que correspondería <b>CONCEDER</b> el presente registro por los argumentos que expone en su dictamen.</p> <p>III) El Encargado de Área Asuntos Jurídicos, comparte lo dictaminado por su Asesor actuante.</p> <p><b>CONSIDERANDO:</b> que esta Dirección, de conformidad con lo dictaminado por su División Legal, resolverá en consecuencia.</p> <p><b>ATENTO:</b> a lo expuesto, a lo que establecen la Ley de Marcas No 17.011 de 25 de setiembre de 1998, su Decreto Reglamentario No. 34/999 de 3 de febrero de 1999 y disposiciones modificativas.</p> <p><b>LA DIRECCION NACIONAL DE LA PROPIEDAD INDUSTRIAL</b></p> <p style="text-align: center;"><b>RESUELVE:</b></p> <p><b>1°.- CONCÉDESE</b> el Registro de la Marca <b>COMPRALO YA</b>, por el conjunto, sin derechos privativos sobre los términos que la componen, artículo 7 de la Ley 17.011, solicitado bajo expediente No. <b>489072</b> a favor de <b>EDALSIR SOCIEDAD ANONIMA de URUGUAY</b>, para distinguir los servicios comprendidos en las Clases internacionales <b>35 y 38</b>.</p> <p><b>2°.- NOTIFÍQUESE</b>, publíquese, efectúense las anotaciones de estilo, entréguese el título bajo recibo y oportunamente archívese.</p>

<b>MARCA</b>	<b>PEDILO YA</b>
<b>ACTA</b>	EDALSIR SOCIEDAD ANONIMA
<b>NOMBRE</b>	489073
<b>NOTIFICACION</b>	<p><b>VISTO:</b> La solicitud de Registro de la Marca <b>PEDILO YA (denominativa)</b>, presentada bajo expediente No. <b>489073</b> a favor de <b>EDALSIR SOCIEDAD ANONIMA de URUGUAY</b>, para distinguir los servicios comprendidos en las Clases internacionales <b>35 y 38</b>.</p> <p><b>RESULTANDO:</b> I) Que contra la misma se dedujo oposición de terceros.</p> <p>II) División Legal dictamina que correspondería <b>DESESTIMAR</b> la presente gestión por los argumentos que expone en su dictamen.</p> <p>III) El Encargado de Área Asuntos Jurídicos comparte lo dictaminado por su Asesor actuante.</p> <p><b>CONSIDERANDO:</b> que esta Dirección, de conformidad con lo dictaminado por su División Legal, resolverá en consecuencia.</p> <p><b>ATENTO:</b> a lo expuesto, a lo que establecen la Ley de Marcas No</p>

	<p>17.011 de 25 de setiembre de 1998, su Decreto Reglamentario No. 34/999 de 3 de febrero de 1999 y disposiciones modificativas.</p> <p style="text-align: center;"><b>LA DIRECCION NACIONAL DE LA PROPIEDAD INDUSTRIAL</b></p> <p style="text-align: center;"><b>R E S U E L V E</b></p> <p><b>1°.- DESESTÍMASE</b> la solicitud de Registro de Marca <b>PEDILO YA</b>, presentada bajo expediente No. <b>489073</b> a nombre de <b>EDALSIR SOCIEDAD ANONIMA de URUGUAY</b>, para distinguir los servicios comprendidos en las Clases internacionales <b>35 y 38</b>.</p> <p><b>2°.- NOTIFÍQUESE</b>, publíquese, efectúense las anotaciones de estilo y oportunamente archívese.</p>
--	--

<b>MARCA</b>	<b>MUNDIAL 2030 URUGUAY ARGENTINA 2030 WORLD CUP</b>
<b>ACTA</b>	441674
<b>NOMBRE</b>	ALBERTO MARTIN SCASSO VOLONTE
<b>NOTIFICACION</b>	<p><b>VISTO:</b> La solicitud de Registro de la Marca <b>MUNDIAL 2030 URUGUAY ARGENTINA 2030 WORLD CUP</b>, presentada bajo expediente No. <b>441674</b> a favor de <b>ALBERTO MARTIN SCASSO VOLONTE de URUGUAY</b>, para distinguir los productos y servicios comprendidos respectivamente en las Clases internacionales <b>12, 16, 30, 32, 42 y 45</b>.</p> <p><b>RESULTANDO: I)</b> Se dedujeron las siguientes oposiciones: A) Por la Fédération Internationale de Football Association (FIFA), fundada en la confundibilidad con sus registros <b>MUNDIAL 2010</b>, No. 371.567; <b>WORLD CUP 2010</b>, No. 371.568; <b>MUNDIAL 2014</b>, No. 400.721; y <b>WORLD CUP 2014</b>, No. 401.062, y en lo previsto en artículos 5 numerales 6 y 7 de la Ley 17011, 6 bis y 10 bis del Convenio de París, y concordantes; y B) Por Daniel Gerard Wild, respecto de las Clases 16, 30 y 32, fundada en la confundibilidad con su solicitud de registro “2030”, No. 432804. Y por su parte, el Área de Signos Distintivos dedujo oposición de oficio, por entender que el signo encuadra en la causal de nulidad prevista por el artículo 5 numeral 8 de la Ley 17011.</p> <p><b>II)</b> División Legal, en su dictamen del 16 de septiembre de 2022, y por los fundamentos allí consignados, aconseja desestimar la oposición promovida por Daniel Gerard Wild, pero amparar la deducida por la Fédération Internationale de Football Association (FIFA), y asimismo mantener la oposición de oficio, y en su mérito, <b>DESESTIMAR</b> el presente registro.</p> <p><b>III)</b> La Encargada de Área Asuntos Jurídicos, en informe de la misma fecha, comparte lo dictaminado por su Asesor actuante.</p> <p><b>CONSIDERANDO:</b> que esta Dirección, de conformidad con los dictámenes precedentes, resolverá en consecuencia.</p> <p><b>ATENTO:</b> a lo expuesto, a lo que establecen la Ley de Marcas No 17.011 de 25 de setiembre de 1998, su Decreto Reglamentario No. 34/999 de 3 de febrero de 1999, disposiciones modificativas y la Resolución del Sr. Ministro de Industria, Energía y Minería No. 30/022</p>

	<p>del 5 de mayo de 2022, designando Encargado de Despacho de esta Dirección.</p> <p style="text-align: center;"><b>LA DIRECCION NACIONAL DE LA PROPIEDAD INDUSTRIAL</b></p> <p style="text-align: center;"><b>RESUELVE</b></p> <p><b>1°.- DESESTÍMASE</b> la solicitud de Registro de Marca <b>MUNDIAL 2030 URUGUAY ARGENTINA 2030 WORLD CUP</b>, presentada bajo expediente No. <b>441674</b> a nombre de <b>ALBERTO MARTIN SCASSO VOLONTE de URUGUAY</b>, para distinguir los productos y servicios comprendidos respectivamente en las Clases internacionales <b>12, 16, 30, 32, 42 y 45</b>.</p> <p><b>2°.- NOTIFÍQUESE</b>, publíquese, y efectúense las anotaciones de estilo. Cumplido, archívese. acr</p>
--	--

<b>MARCA</b>	<b>MUNDIAL 2030</b>
<b>ACTA</b>	441642
<b>NOMBRE</b>	ALBERTO MARTIN SCASSO VOLONTE
<b>NOTIFICACION</b>	<p><b>VISTO:</b> La solicitud de Registro de la Marca <b>MUNDIAL 2030</b>, presentada bajo expediente No. <b>441642</b> a favor de <b>ALBERTO MARTIN SCASSO VOLONTE de URUGUAY</b>, para distinguir los productos y servicios comprendidos respectivamente en las Clases internacionales <b>9, 16, 25, 35, 38 y 41</b>.</p> <p><b>RESULTANDO: I)</b> Se dedujeron las siguientes oposiciones: A) Por la Asociación Uruguaya de Fútbol, fundada en el artículo 5 numerales 6, 7 y 8 y concordantes de la Ley 17011; B) Por la Banca de Cubierta Colectiva de Quinielas de Montevideo, respecto de todas las Clases solicitadas excepto la 25, fundada en la confundibilidad con sus marcas <b>PRO MUNDIAL</b> y <b>FUTBOL MUNDIAL</b>, Nos. 440433 y 431769 respectivamente; C) Por Daniel Gerard Wild, respecto de las Clases 16, 38 y 41, fundada en la confundibilidad con su solicitud de registro "2030", No. 432804; y D) Por la Fédération Internationale de Football Association (FIFA), fundada en la confundibilidad con sus registros <b>MUNDIAL 2010</b>, No. 371.567; <b>WORLD CUP 2010</b>, No. 371.568; <b>MUNDIAL 2014</b>, No. 400.721; y <b>WORLD CUP 2014</b>, No. 401.062, y en lo previsto en artículos 5 numerales 6 y 7 de la Ley 17011, 6 bis y 10 bis del Convenio de París, y concordantes. Y por su parte, el Área de Signos Distintivos dedujo oposición de oficio, por entender que el signo encuadra en la causal de nulidad prevista por el artículo 5 numeral 8 de la Ley 17011.</p> <p><b>II)</b> División Legal, en su dictamen del 16 de septiembre de 2022, y por los fundamentos allí consignados, aconseja desestimar las oposiciones promovidas por la Asociación Uruguaya de Fútbol, por la Banca de Cubierta Colectiva de Quinielas de Montevideo y por Daniel Gerard Wild, pero amparar la deducida por la Fédération Internationale de</p>

	<p>Football Association (FIFA), y asimismo mantener la oposición de oficio, y en su mérito, <b>DESESTIMAR</b> el presente registro.</p> <p><b>III)</b> La Encargada de Área Asuntos Jurídicos, en informe de la misma fecha, comparte lo dictaminado por su Asesor actuante.</p> <p><b>CONSIDERANDO:</b> que esta Dirección, de conformidad con los dictámenes precedentes, resolverá en consecuencia.</p> <p><b>ATENCIÓN:</b> a lo expuesto, a lo que establecen la Ley de Marcas No 17.011 de 25 de setiembre de 1998, su Decreto Reglamentario No. 34/999 de 3 de febrero de 1999, disposiciones modificativas y la Resolución del Sr. Ministro de Industria, Energía y Minería No. 30/022 del 5 de mayo de 2022, designando Encargado de Despacho de esta Dirección.</p> <p style="text-align: center;"><b>LA DIRECCION NACIONAL DE LA PROPIEDAD INDUSTRIAL</b></p> <p style="text-align: center;"><b>RESUELVE</b></p> <p><b>1°.- DESESTÍMASE</b> la solicitud de Registro de Marca <b>MUNDIAL 2030</b>, presentada bajo expediente No. <b>441642</b> a nombre de <b>ALBERTO MARTIN SCASSO VOLONTE de URUGUAY</b>, para distinguir los productos y servicios comprendidos respectivamente en las Clases internacionales <b>9, 16, 25, 35, 38 y 41</b>.</p> <p><b>2°.- NOTIFIQUESE</b>, publíquese, y efectúense las anotaciones de estilo. Cumplido, archívese</p>
--	--

## **NOTIFICACIONES DE RECURSOS**

De conformidad con lo establecido por el numeral 4° del artículo 80 de la Ley 17.011 del 25 de setiembre de 1998 y artículo 87 del decreto N° 34/999 del 3 de febrero de 1999, se notifica a quien se cita a continuación, por razones de su interés, debe presentarse en sección Recursos de la Dirección Nacional de Propiedad Industrial, sita en la calle Rincón 723, 03er. Piso.

<b>MARCA</b>	<b>PETRA</b>
<b>ACTA</b>	416034
<b>NOMBRE</b>	A SANDRA VERÓNICA CANDELLOT SOLECIO
<b>NOTIFICACION</b>	<p><b>VISTO:</b> La acción de cancelación de la marca <b>PETRA</b>, promovida por <b>PETRA STORE SRL</b>, de acuerdo al artículo 19 de la Ley 17011 de 25/9/998, en la redacción dada por el artículo 187 de la Ley 19.149, del 24/10/013.</p> <p><b>RESULTANDO: I)</b> Que dicha marca es de tipo denominativo, se concedió bajo Acta No. 416034 para distinguir “Vestimenta” de la Clase internacional 25, por resolución del 6 de julio de 2012, a Sandra Verónica Candelot Solecio de Uruguay.</p> <p><b>II)</b> Que la compareciente promovió la cancelación por falta de uso del registro citado, en base a lo expuesto a fojas 1 y ss, de la pieza correspondiente.</p> <p><b>III)</b> Que la División Recursos y otras Acciones se expidió por dictamen del 3 de agosto de 2022, expresando que la acción se promovió en tiempo y forma, tuvo por acreditada la titularidad de interés calificado por parte de la accionante, y por los motivos allí expuestos, y dado que la titular del registro no aportó prueba alguna sobre el uso del mismo, aconsejó hacer lugar a la cancelación promovida.</p> <p><b>IV)</b> La Encargada de Área Asuntos Jurídicos, en informe del 18 de agosto de 2022, comparte lo dictaminado por su Asesor actuante.</p> <p><b>CONSIDERANDO:</b> que esta Dirección, de conformidad con los informes referidos, resolverá en consecuencia.</p> <p><b>ATENTO:</b> A lo precedentemente expuesto, a lo que establecen las disposiciones precitadas, la Ley No. 17011 de 25/9/998, Decretos Reglamentarios Nos. 34/999 de 3/2/999, 277/014 de 1/10/014 y concordantes, y la Resolución del Sr. Ministro de Industria, Energía y Minería No. 30/022 del 5 de mayo de 2022, designando Encargado de Despacho de esta Dirección.</p> <p style="text-align: center;"><b>LA DIRECCION NACIONAL DE LA PROPIEDAD INDUSTRIAL</b></p> <p style="text-align: center;"><b>R E S U E L V E</b></p> <p><b>1°.- CANCELÁSE</b> el registro de la marca <b>PETRA</b>, concedida a favor de <b>SANDRA VERÓNICA CANDELLOT SOLECIO de URUGUAY</b>, bajo Acta No. <b>416034</b>, para distinguir según detalle la Clase internacional <b>25 (Vestimenta)</b>.</p>



	2°.- <b>NOTIFÍQUESE</b> , intímese la entrega del título, efectúense las anotaciones de estilo y publíquese. Cumplido, archívese. acr
--	--

<b>MARCA</b>	<b>BRANDS FOR LESS</b>
<b>ACTA</b>	478264
<b>NOMBRE</b>	BRANDS FOR LESS S/A
<b>NOTIFICACION</b>	Documento: Anulación Nro. MA/ 2022/ 012944 Expediente: Marca Nro. 478264 Signo: BRANDS FOR LESS (mixta) Titular: BRANDS FOR LESS S/A Clase(s): 35  Montevideo, 29 de agosto de 2022  De la Acción de Anulación interpuesta, confírese traslado al titular del presente registro por el plazo de 30 días corridos, perentorios e improrrogables en mérito a lo dispuesto por el art. 20 y ss. de la Ley 17.011, y art. 20 y ss. del Decreto Reglamentario N° 34/999.

<b>MARCA</b>	<b>IN</b>
<b>ACTA</b>	419900
<b>NOMBRE</b>	DOCRILAN S.A.
<b>NOTIFICACION</b>	<b>Expediente:</b> Marca Nro. 419900 <b>Signo:</b> IN (mixta) <b>Titular:</b> DOCRILAN S.A. <b>Clase(s):</b> 41 y 43  Montevideo, 1 de septiembre de 2022  De acuerdo con el dictamen de la División Recursos y otras Acciones del día de la fecha, y previo a dictamen final, se confiere vista de lo actuado por el término de diez días hábiles, perentorios e improrrogables, conforme artículo 16 del Decreto 34/999 del 3/2/999.

<b>MARCA</b>	<b>CORAL</b>
<b>ACTA</b>	459255
<b>NOMBRE</b>	GERARDO CARDONA
<b>NOTIFICACION</b>	<b>Expediente:</b> Marca Nro. 459255 <b>Signo:</b> CORAL <b>Titular:</b> GERARDO CARDONA <b>Clase(s):</b> 35  Montevideo, 12 de agosto de 2022  De acuerdo con el dictamen de la División Recursos y otras Acciones

	del día de la fecha se confiere vista por el término de diez días hábiles, perentorios e improrrogables, conforme artículo 16 del Decreto 34/999 del 3/2/999.
--	---

<b>MARCA</b>	<b>OHLALA!</b>
<b>ACTA</b>	487019
<b>NOMBRE</b>	PENÉLOPE MIRANDA
<b>NOTIFICACION</b>	<p><b>Documento:</b> Recurso Nro. MA/ 2022/ 022239  <b>Expediente:</b> Marca Nro. 487019  <b>Signo:</b> OHLALA!  <b>Titular:</b> PENÉLOPE MIRANDA  <b>Clase(s):</b> 43</p> <p style="text-align: right;">Montevideo, 31 de agosto de 2022</p> <p>Del recurso interpuesto confiérese traslado por el término de 10 días hábiles.</p>

<b>MARCA</b>	<b>OLMOS</b>
<b>ACTA</b>	408870
<b>NOMBRE</b>	PABLO MARTIN CORDANO CASTELLS
<b>NOTIFICACION</b>	<p><b>VISTO:</b> La acción de cancelación por falta de uso del registro marcario <b>OLMOS</b>, promovida el 20 de enero de 2021 por la firma <b>ZALWIN S.A.</b>  <b>RESULTANDO: I)</b> Que la compareciente promovió la cancelación del registro precitado, en base a lo expuesto a fojas 1 y ss. de la pieza correspondiente, al amparo de lo establecido por el artículo 19 de la Ley N° 17011 de 25/9/998, en la redacción dada por el artículo 187 de la Ley N° 19.149 del 24/10/013.  <b>II)</b> Que el registro en cuestión se concedió bajo Acta N° 408870, a partir del 17 de febrero de 2012.  <b>III)</b> Que la División Recursos y otras Acciones, informa el 24 de agosto de 2022 que la cancelación no puede prosperar, ya que el registro caducó el 17 de febrero de 2022 sin que se solicitara su renovación, y ha vencido incluso el plazo de gracia previsto en el artículo 18 de la Ley N° 17011, por lo cual el accionamiento ha quedado sin objeto y correspondería no hacer lugar al mismo.  <b>IV)</b> La Encargada de Área Asuntos Jurídicos, en informe del 1° de setiembre de 2022, comparte lo dictaminado por su Asesor actuante.  <b>CONSIDERANDO:</b> que esta Dirección comparte los dictámenes precedentes y resolverá en consecuencia.  <b>ATENTO:</b> a lo expuesto, lo establecido en la Ley de Marcas No 17.011 de 25 de setiembre de 1998, su Decreto Reglamentario No. 34/999 de 3 de febrero de 1999, disposiciones modificativas y la Resolución del Sr. Ministro de Industria, Energía y Minería No. 30/022 del 5 de mayo de 2022, designando Encargado de Despacho de esta Dirección.</p> <p style="text-align: center;"><b>LA DIRECCIÓN NACIONAL DE LA PROPIEDAD INDUSTRIAL</b></p>

<b>RESUELVE</b>
<p>1°) <b>NO HA LUGAR</b> a la acción de cancelación por falta de uso promovida por <b>ZALWIN S.A.</b> respecto del registro marcario <b>OLMOS</b>, concedido a <b>PABLO MARTIN CORDANO CASTELLS de Uruguay</b>, bajo Acta No. <b>408870</b>, para distinguir los servicios incluidos en la Clase internacional <b>37</b>.</p> <p>2°) <b>NOTIFÍQUESE</b>, publíquese, efectúense las anotaciones de estilo, y cumplido, archívese.</p> <p>acr</p>

<b>MARCA</b>	<b>WABI</b>
<b>ACTA</b>	439.270
<b>NOMBRE</b>	ELIS CARLA PARODI CAYAFA
<b>NOTIFICACION</b>	<p><b>VISTO:</b> Los recursos de revocación y jerárquico interpuestos por la firma <b>THE COCA-COLA COMPANY</b>, contra la Resolución de esta Dirección de fecha 13 de julio de 2021.</p> <p><b>RESULTANDO:</b> I) Que la referida Resolución <b>CONCEDIÓ PARCIALMENTE</b> el registro de la marca <b>WABI (MIXTA)</b>, solicitada bajo acta No. <b>439.270</b>, a favor de <b>ELIS CARLA PARODI CAYAFA</b>, concediéndola para distinguir productos de la clase internacional <b>25</b> y desestimándola para servicios de la clase internacional <b>35</b>.</p> <p>II) Que la firma recurrente interpuso en tiempo y forma los recursos administrativos correspondientes, solicitando la revocación del acto.</p> <p>III) Que la Asesoría Letrada de esta Dirección entiende, tal como se desprende del Dictamen que antecede, que existen razones suficientes para revisar el criterio adoptado en la Resolución impugnada, y en su mérito aconseja la revocación del acto impugnado y en su lugar se deniegue el registro solicitado para ambas clases.</p> <p><b>CONSIDERANDO:</b> que esta Dirección, comparte lo dictaminado por su Asesoría Letrada y resolverá en consecuencia.</p> <p><b>ATENTO:</b> a lo expuesto, y a lo que establecen la Ley 17.011 de 25 setiembre de 1998, su Decreto Reglamentario No. 34/999 de 3 de febrero de 1999 y disposiciones modificativas.</p> <p style="text-align: center;"><b>LA DIRECCIÓN NACIONAL DE LA PROPIEDAD INDUSTRIAL</b></p> <p style="text-align: center;"><b>RESUELVE:</b></p> <p>1°.- <b>AMPARAR</b> el recurso de revocación interpuesto y en su mérito <b>REVOCAR</b> la Resolución de esta Dirección de fecha 13 de julio de 2021, por la que se <b>CONCEDIÓ PARCIALMENTE</b> el registro de la marca <b>WABI (MIXTA)</b>, solicitada bajo acta No. <b>439.270</b>, a favor de <b>ELIS CARLA PARODI CAYAFA</b>, concediéndola para distinguir productos de la clase internacional <b>25</b> y desestimándola para servicios de la clase internacional <b>35</b>.</p>

	<p>2°.- <b>DESESTIMAR</b> el Registro de la Marca <b>WABI (MIXTA)</b>, presentado bajo expediente No. <b>439.270</b>, a favor de <b>ELIS CARLA PARODI CAYAFA</b>, para distinguir los productos y servicios comprendidos en las Clases Internacionales <b>25 y 35</b>.</p> <p>3°.- <b>NOTIFÍQUESE</b>, publíquese, efectúense las anotaciones de estilo y oportunamente archívese.</p>
--	--

<b>MARCA</b>	<b>WABI</b>
<b>ACTA</b>	493.270
<b>NOMBRE</b>	<i>ELIS CARLA PARODI CAYAFA</i>
<b>NOTIFICACION</b>	<p><b>VISTO:</b> Los recursos de revocación y jerárquico interpuestos por la firma <b>THE COCA-COLA COMPANY</b>, contra la Resolución de esta Dirección de fecha 13 de julio de 2021.</p> <p><b>RESULTANDO:</b> I) Que la misma <b>CONCEDIÓ PARCIALMENTE</b> la solicitud de la marca <b>WABI (mixta)</b>, solicitada bajo acta <b>493.270</b>, a nombre de <b>ELIS CARLA PARODI CAYAFA</b>, concediéndola para distinguir productos de la Clase Internacional 25, y desestimándola para servicios de la clase internacional 35.</p> <p>II) Que la firma recurrente interpuso en tiempo y forma los recursos administrativos correspondientes.</p> <p>III) Por Resolución de fecha 2 de setiembre de 2022 se hizo lugar al recurso interpuesto, revocándose la Resolución impugnada y desestimando el registro.</p> <p>IV) Se advierte que en la Resolución de 2 de setiembre se padeció un error al indicar el número de acta correspondiente, habiéndose consignado el número 439.270 cuando debió indicarse 493.270.</p> <p><b>CONSIDERANDO:</b> Que ello constituye un evidente error material sin incidencia sobre la cuestión de fondo.</p> <p><b>ATENTO:</b> a lo expuesto, y a lo que establecen la Ley 17.011 de 25 setiembre de 1998, su Decreto Reglamentario No. 34/999 de 3 de febrero de 1999 y disposiciones modificativas.</p> <p style="text-align: center;"><b>LA DIRECCIÓN NACIONAL DE LA PROPIEDAD INDUSTRIAL</b></p> <p style="text-align: center;"><b>RESUELVE:</b></p> <p>1°.- <b>MODIFÍCASE</b> la Resolución de esta Dirección de fecha 2 de setiembre de 2022 por la que se hizo lugar al recurso de revocación interpuesto y se desestimó el Registro de la Marca <b>WABI (mixta)</b>, presentado bajo expediente No. <b>493.270</b>, a favor de <b>ELIS CARLA PARODI CAYAFA</b>, para distinguir los productos y servicios comprendidos en las Clases Internacionales <b>25 y 35</b> en su Resultando I y en los numerales 1° y 2° de la parte Resolutiva, <b>DONDE DICE: “439.270”, DEBE DECIR: “493.270”</b>.</p> <p>2°.- <b>NOTIFÍQUESE</b>, publíquese, efectúense las anotaciones de estilo y oportunamente archívese.</p>

## ***SOLICITUDES DE PATENTES DE INVENCION***

**(19) Dirección Nacional de la Propiedad Industrial – URUGUAY**

**(12) Invención**

**(11) UY a/ 038949**

- (51) Clasificación Internacional:** C 07K 16/46, C 12N 15/11, 15/85, 5/10, C 12P 21/08, A 61K 39/395  
// A 61P 35/00
- (22) Fecha de presentación:** 06/11/2020
- (30) Datos de prioridad:** 62/931,783 06/11/2019 US y 62/953,120 23/12/2019 US
- (71) Solicitante:** AMGEN INC. [US] y Amgen Research (Munich) GmbH [DE]
- (72) Inventor:** ARVEDSON, Tara [US]; RAUM, Tobias [DE]; DAHLHOFF, Christoph [DE]; BAILIS, Julie [US]; ANLAHR, Jonas [DE]; CHUN, Matthew [US]; D'ANGELO, Igor [IT]; EVERTS, Stephanie [DE]; FRIEDRICH, Matthias [DE]; GAEDTKE, Lars [DE]; GOLDSTEIN, Rebecca [US]; HONER, Jonas Karl-Josef [DE]; KISCHEL, Roman [DE]; KLINGER, Matthias [DE]; KUFER, Peter [DE]; MUENZ, Markus [DE]; NAEGELE, Virginie [DE]; PANZER, Marc [DE]; RAU, Doris [DE]; ULLRICH, Ines [DE]; HOFFMANN, Patrick [DE]
- (74) Agente/apoderado:** FABIANA PENADES (216)
- (54) Título:** MOLÉCULAS DE UNIÓN A ANTÍGENO DE MULTIDIRECCIONAMIENTO PARA SU USO EN ENFERMEDADES PROLIFERATIVAS
- (57) Resumen:** La presente invención proporciona moléculas de unión a antígeno biespecíficas caracterizadas por comprender un primer y un segundo dominio de unión, que se une cada uno a CS1, BCMA, CD20, CD22, FLT3, CD123, CLL1, MSLN, CDH3 o EpCAM, un tercer dominio que se une a un epítipo extracelular de la cadena CD3e humana y de Macaca y opcionalmente un cuarto dominio, que está en una modalidad Fc. Además, la invención proporciona un polinucleótido, que codifica la molécula de unión a antígeno, un vector que comprende este polinucleótido, células hospedadoras que expresan la construcción y una composición farmacéutica que comprende la misma.

**(19) Dirección Nacional de la Propiedad Industrial – URUGUAY****(12) Invención****(11) UY a/ 039516**

- (51) **Clasificación Internacional:** C 07D 221/20, 401/12, 401/14, 405/12, 413/12, 471/04, 487/04, A 61K 31/438, 31/4427, 31/495  
// A 61P 25/00
- (22) **Fecha de presentación:** 11/11/2021
- (30) **Datos de prioridad:** 63/113,662 13/11/2020 US
- (71) **Solicitante:** H. LUNDBECK A/S [DK]
- (72) **Inventor:** Wiener, John J.M. [US]; Grice, Cheryl A [US]; Buzard, Daniel J. [US]; Cisar, Justin S. [US]; Weber, Olivia D. [US]; Allan, Amy [US]; Raffaele, Nicholas [US]; Moody, Jeanne V. [US]; Shaghafi, Michael B [US]
- (74) **Agente/apoderado:** Gustavo Fischer Fleurquin (94)
- (54) **Título:** UN INHIBIDOR DE MAGL

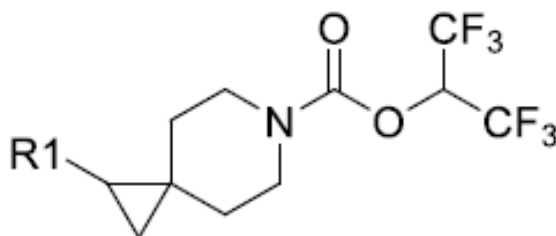

- (57) **Resumen:** En la presente se proporcionan compuestos de 6-azaespiro[2.5]octano-6-carboxilato de 1,1,1,3,3,3-hexafluoropropan-2-ilo sustituidos y composiciones farmacéuticas que comprenden dichos compuestos. Los compuestos y composiciones proporcionados en la presente son útiles como inhibidores de MAGL. Además, los compuestos y composiciones y proporcionados en la presente son útiles para el tratamiento de enfermedades y trastornos que se benefician de la inhibición de MAGL.

**(19) Dirección Nacional de la Propiedad Industrial – URUGUAY****(12) Invención****(11) UY a/ 039523**

- (51) **Clasificación Internacional:** G 06T 1/00  
(22) **Fecha de presentación:** 18/11/2021  
(30) **Datos de prioridad:** 20200103250 21/11/2020 AR  
(71) **Solicitante:** Fernando Pablo PERAL BELMONT [AR] y Mariano BONAGLIA [AR]  
(72) **Inventor:** Fernando Pablo PERAL BELMONT [AR]; Mariano BONAGLIA [AR]  
(74) **Agente/apoderado:** JUAN MIGUEL FREIRA SERRAT (19)  
(54) **Título:** SISTEMA DE VIGILANCIA

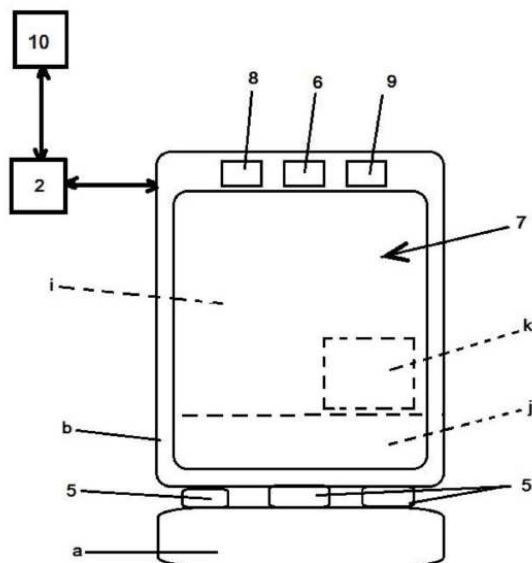

- (57) **Resumen:** La estructura del punto de control se compone de una parte inferior fija y otra superior orientable por un servomecanismo comandado desde la CPU según la información recibida desde las cámaras y los sensores. La pantalla es divisible en una primera porción en función de espejo, una segunda porción para transmitir publicidad y noticias y una ventana que abre a demanda del operador o del cliente habilitando la comunicación visual entre ambos. El punto de control se vincula a un servidor administrado por un operador. La CPU genera y recibe información visual y de audio en tiempo real.

**(19) Dirección Nacional de la Propiedad Industrial – URUGUAY****(12) Invención****(11) UY a/ 039623**

- (51) **Clasificación Internacional:** A 01N 25/32, 37/10, 37/16, 33/16, 33/24  
 (22) **Fecha de presentación:** 04/02/2022  
 (30) **Datos de prioridad:** 63/145,965 04/02/2021 US  
 (71) **Solicitante:** CORTEVA AGRISCIENCE LLC [US]  
 (72) **Inventor:** Jeremy Kister [FR]; Bin Wei [CN]; James Gifford [US]; David Simpson [US]; Mei Li [US]  
 (74) **Agente/apoderado:** JUAN LAPENNE DE SALTERAIN (211)  
 (54) **Título:** HERBICIDAS AUXÍNICOS Y MÉTODOS DE USO

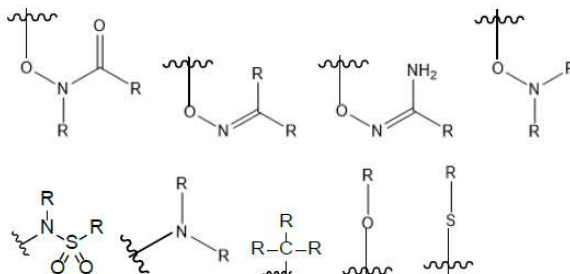
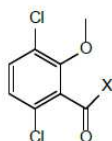

- (57) **Resumen:** Al menos algunos aspectos de esta descripción incluyen uno o más herbicidas auxínicos con una volatilidad relativamente baja. Algunos de estos compuestos pueden ser especialmente útiles cuando se usan en el proceso de cultivo de vegetales comercialmente importantes. También se describen en este documento métodos para usar estos principios activos para controlar el crecimiento y la propagación de vegetales no deseados y/o para acelerar el crecimiento de aquellos vegetales deseados.



**(19) Dirección Nacional de la Propiedad Industrial – URUGUAY****(12) Invención****(11) UY a/ 039624**

- (51) Clasificación Internacional:** A 23K 10/16, 10/30, A 23L 33/105, A 61K 35/748, 36/03, 36/05
- (22) Fecha de presentación:** 04/02/2022
- (30) Datos de prioridad:** 2101179 08/02/2021 FR
- (71) Solicitante:** AGRO INNOVATION INTERNATIONAL [FR]
- (72) Inventor:** LAZA KNOERR, Anca, L. [FR]; POINT, Sandra [FR]; DE TONNAC, Auriane [FR]; DUMARGUE, Philippe [FR]
- (74) Agente/apoderado:** JUAN LAPENNE DE SALTERAIN (211)
- (54) Título:** COMPOSICIÓN DE ALIMENTOS Y BEBIDAS PARA ANIMALES NO HUMANOS

- (57) Resumen:** La presente invención se refiere al campo de los alimentos y/o bebidas para animales no humanos, y en particular a la combinación de algas espirulina y *Ascophyllum nodosum* o sus extractos para alimentos y/o bebidas para animales no humanos, en particular para los animales de granja, más concretamente los animales de granja con fines productivos.

## (19) Dirección Nacional de la Propiedad Industrial – URUGUAY

(12) Invención

(11) UY a/ 039625

- (51) **Clasificación Internacional:** C 07D 237/10, 471/14, 498/14, 513/14, A 61K 31/4353, 31/501, 31/5025, 31/5383, 31/542, 31/553, 31/554  
// A 61P 35/00
- (22) **Fecha de presentación:** 04/02/2022
- (30) **Datos de prioridad:** PCT/CN2021/076144 09/02/2021 CN; PCT/CN2021/091050 29/04/2021 CN; PCT/CN2021/117189 08/09/2021 CN; PCT/CN2021/119368 18/09/2021 CN; PCT/CN2021/124714 19/10/2021 CN; PCT/CN2021/128807 04/11/2021 CN y PCT/CN2021/129056 05/11/2021 CN
- (71) **Solicitante:** Jacobio Pharmaceuticals Co., Ltd. [CN]
- (72) **Inventor:** Hao ZHANG [CN]; Cunbo MA [CN]; Wei LONG [CN]; Haijun LI [CN]; Mingming CHEN [CN]; Di KANG [CN]; Qinglong LI [CN]; Lei ZHANG [CN]; Man YAN [CN]; Yanping WANG [CN]; Amin LI [CN]
- (74) **Agente/apoderado:** GONZALO FERNÁNDEZ SECCO (34)
- (54) **Título:** DERIVADOS TRICÍCLICOS ÚTILES COMO INHIBIDORES DE PARP7

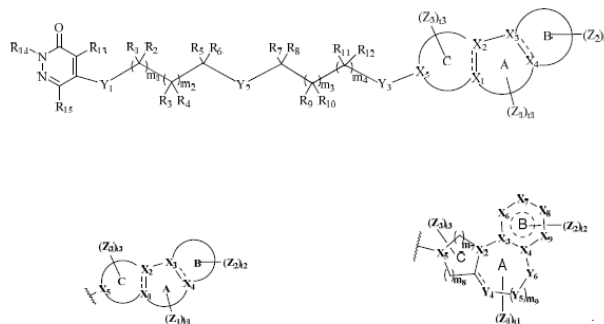

- (57) **Resumen:** La invención se relaciona con un compuesto de la fórmula (I) que inhibe la actividad de PARP7, un estereoisómero del mismo, un derivado deuterado del mismo, o una sal farmacéuticamente aceptable del mismo, un intermediario para preparar el compuesto, un proceso para preparar el compuesto, una composición que lo comprende y métodos de uso del mismo.

**(19) Dirección Nacional de la Propiedad Industrial – URUGUAY****(12) Invención****(11) UY a/ 039629**

- (51) Clasificación Internacional:** C 07K 14/415, C 12N 15/11, 15/82, 5/10, A 01H 5/00, A 01N 65/00
- (22) Fecha de presentación:** 09/02/2022
- (30) Datos de prioridad:** 63/147,849 10/02/2021 US y 63/209,005 10/06/2021 US
- (71) Solicitante:** SYNGENTA CROP PROTECTION AG [CH]
- (72) Inventor:** Qingli LIU [US]; Becky Welsh BREITINGER [US]; FARMER, Andrew David [US]; Thomas Joseph CURLEY Jr. [US]
- (74) Agente/apoderado:** JUAN LAPENNE DE SALTERAIN (211)
- (54) Título:** NUEVOS GENES DE RESISTENCIA ASOCIADOS A RESISTENCIA A ENFERMEDADES EN SOJA

- (57) Resumen:** La presente invención se refiere a métodos y composiciones para identificar, seleccionar y/o producir una planta o germoplasma resistente a patógenos (por ejemplo, planta o germoplasma de soja) utilizando genes derivados de *Glycine tomentella*. Se proporcionan genes candidatos capaces de conferir resistencia a patógenos (por ejemplo, a la roya de la soja asiática). También se proporciona una planta o germoplasma que se ha identificado, seleccionado y/o producido mediante cualquiera de los métodos de la presente invención. También se proporcionan semillas, plantas y germoplasmas resistentes a patógenos.

**(19) Dirección Nacional de la Propiedad Industrial – URUGUAY****(12) Invención****(11) UY a/ 039631**

- (51) **Clasificación Internacional:** C 12Q 1/68, A 01H 1/00, C 12N 15/11, 15/82
- (22) **Fecha de presentación:** 14/02/2022
- (30) **Datos de prioridad:** 63/148,439 11/02/2021 US
- (71) **Solicitante:** Pairwise Plants Services, Inc. [US]
- (72) **Inventor:** Shunhong Dai, [US]; Huachun Larue [US]; Benjamin Julius [US]; Thomas L. Slewinski [US]; HaeJin Kim [KR]; Lolita George Mathew [US]; Brent Delbert Brower-Toland [US]
- (74) **Agente/apoderado:** JUAN LAPENNE DE SALTERAIN (211)
- (54) **Título:** MÉTODOS Y COMPOSICIONES PARA MODIFICAR LOS NIVELES DE CITOQUININA OXIDASA EN PLANTAS
- (57) **Resumen:** La presente invención se refiere a composiciones y métodos para mejorar/potenciar características de rendimiento modificando los niveles de citoquinina oxidasa (CKX) en una planta. La invención se refiere además a plantas producidas usando los métodos y composiciones de la invención.

**(19) Dirección Nacional de la Propiedad Industrial – URUGUAY****(12) Invención****(11) UY a/ 039636**

- (51) **Clasificación Internacional:** A 22C 17/14  
 (22) **Fecha de presentación:** 16/02/2022  
 (30) **Datos de prioridad:** 2027565 16/02/2021 NL y 2027566 16/02/2021 NL  
 (71) **Solicitante:** CTH B.V. [NL]  
 (72) **Inventor:** Johannes Wilhelmus Nicolaas van Lijssel [NL]; Johannes Frederik Hansen [NL]; Cederic Cecilius Hendrikus Johannes Maria Rutting [NL]; Michal Grzyb [PL]; Jeroen René Maria Colpaert [BE]; Sander Hendrik Luciën Hochstenbach [NL]; Rob Den Besten [NL]  
 (74) **Agente/apoderado:** FABIANA PENADES (216)  
 (54) **Título:** SEPARACIÓN DE UN INTESTINO DE UN PAQUETE INTESTINAL

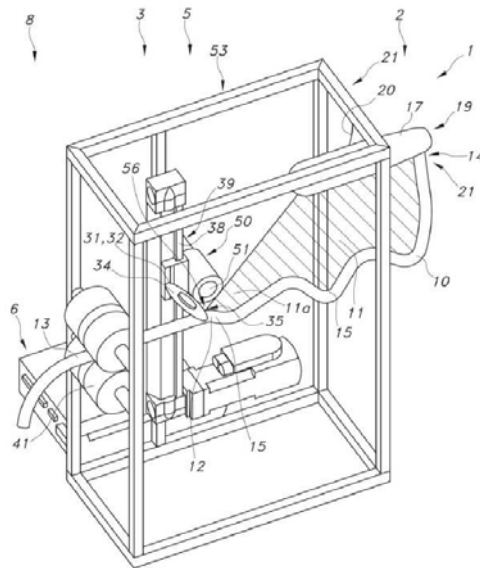

- (57) **Resumen:** La invención proporciona un sistema (1) para separar un intestino (10) de un paquete intestinal (19) que comprende un resto de paquete (17) y una membrana (11) que conecta el intestino (10) al resto de paquete (17); el sistema (1) comprende (i) una zona de retención (2) que comprende una ubicación de retención (21), (ii) una zona de separación (3), (iii) una zona de detección (5), (iv) una zona de recolección (8), (v) un elemento de retención (20), (vi) un elemento de transporte (41), (vii) un sensor (51), y (viii) un sistema de control (6)

**(19) Dirección Nacional de la Propiedad Industrial – URUGUAY****(12) Invención****(11) UY a/ 039637**

- (51) **Clasificación Internacional:** A 01N 43/08  
// A 01P 21/00
- (22) **Fecha de presentación:** 16/02/2022
- (30) **Datos de prioridad:** 2102147.2 16/02/2021 GB
- (71) **Solicitante:** SYNGENTA CROP PROTECTION AG [CH]
- (72) **Inventor:** QUINODOZ, Pierre [FR]; YOSHIMURA, Masahiko [JP]; FONNE-PFISTER, Raymonde [FR]; BERGNA, Alessandro [IT]; OYSERMAN, Ben Ozer [US]; LEIPNER, Joerg [DE]; DE MESMAEKER, Alain [BE]; SCREPANTI, Claudio [IT]
- (74) **Agente/apoderado:** JUAN LAPENNE DE SALTERAIN (211)
- (54) **Título:** MÉTODOS PARA INCREMENTAR LA EFICACIA DEL USO DE NUTRIENTES DE PLANTAS

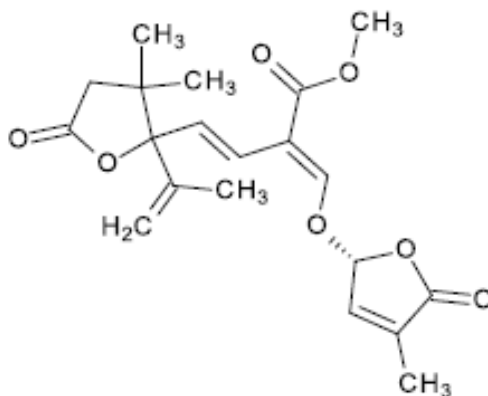

- (57) **Resumen:** La presente invención se refiere a un método para incrementar la eficacia del uso de nutrientes de una planta aplicando a la planta, una parte de la planta, un extracto de la planta, material de propagación de la planta o una ubicación en la que se cultiva la planta, un compuesto de fórmula (I) (I) o una composición que comprende un compuesto de fórmula (I).

**(19) Dirección Nacional de la Propiedad Industrial – URUGUAY****(12) Invención****(11) UY a/ 039639**

- (51) **Clasificación Internacional:** B 65B 11/04, 11/58, 61/06, B 65H 16/00  
(22) **Fecha de presentación:** 22/02/2022  
(30) **Datos de prioridad:** 2021900460 22/02/2021 AU  
(71) **Solicitante:** AAA Packaging Supplies Pty Ltd [AU]  
(72) **Inventor:** Timothy SALISBURY [AU]; Jonathan SALISBURY [AU]  
(74) **Agente/apoderado:** GONZALO FERNÁNDEZ SECCO (34)  
(54) **Título:** DISPOSITIVO, SISTEMA, MÉTODO Y PRODUCTO PARA EMBALAJE EXTENSIBLE

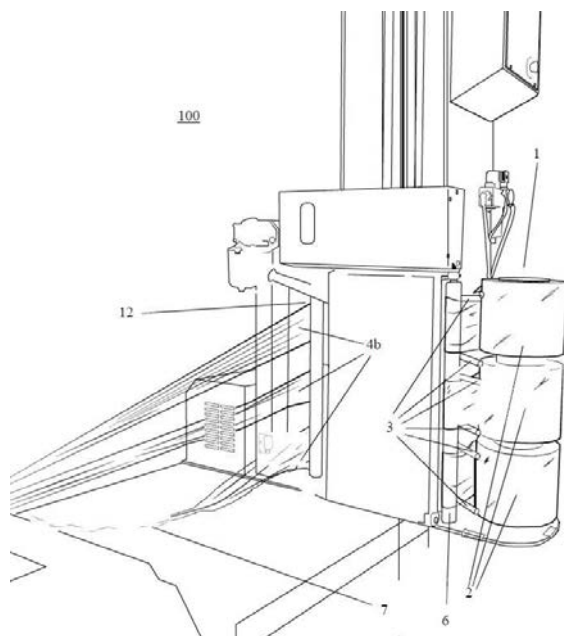

- (57) **Resumen:** Invención que refiere a aparatos para embalaje de productos con film extensible comprendiendo: un carro portarrollos de film para dispensar una banda de film(s) desde un mandril(s) con un único rollo de film; un mecanismo de trenzado para trenzar al menos una banda de film enrollando al menos un borde lateral del film; un dispositivo de estirado previo para estirar el film previamente; un carrusel para embalaje extensible para envolver el film trenzado y estirado previamente alrededor de los productos, donde al menos una banda de film pasa por el mecanismo de trenzado antes de pasar por el estirado previo.

**(19) Dirección Nacional de la Propiedad Industrial – URUGUAY****(12) Invención****(11) UY a/ 039641**

- (51) **Clasificación Internacional:** A 61K 31/352, G 01N 33/94, G 06K 7/10, G 06Q 10/08  
(22) **Fecha de presentación:** 23/02/2022  
(30) **Datos de prioridad:** 63/152,548 23/02/2021 US  
(71) **Solicitante:** Metrc LLC [US]  
(72) **Inventor:** Dilek DAGDELEN UYSAL [US]; Jeffrey Lane WELLS [US]  
(74) **Agente/apoderado:** FABIANA PENADES (216)  
(54) **Título:** MÉTODO DE REGULACIÓN DEL CANNABIS BASADO EN DATOS

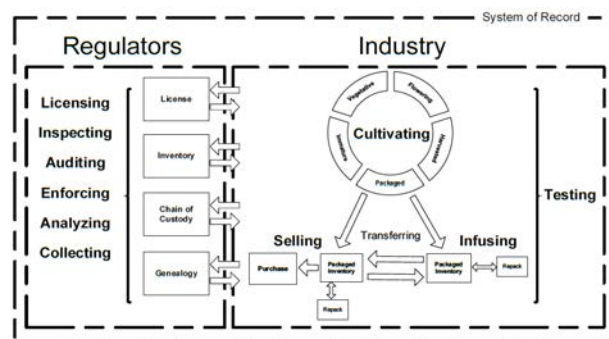

- (57) **Resumen:** Un método y un sistema de acuerdo con la invención donde se establecen normas industriales para cada paso del proceso de producción, cultivo, cosecha y envasado para que un sector regulado las siga con respecto a un producto regulado. Una forma de realización se refiere al producto regulado cannabis donde el producto es legal si registra debidamente en el sistema mientras que cualquier producto que no se registra en el sistema es ilegal.



## (19) Dirección Nacional de la Propiedad Industrial – URUGUAY

(12) Invención

(11) UY a/ 039642

- (51) **Clasificación Internacional:** C 07D 231/56, 405/12, 491/048, A 61K 31/416, 31/4355  
// A 61P 31/14
- (22) **Fecha de presentación:** 24/02/2022
- (30) **Datos de prioridad:** 63/154,318 26/02/2021 US; 63/168,705 31/03/2021 US; 63/171,895 07/04/2021 US y 63/293,339 23/12/2021 US
- (71) **Solicitante:** ENANTA PHARMACEUTICALS, INC. [US]
- (72) **Inventor:** Yat Sun OR [US]; Adam SZYMANKI [US]; Kevin MCGRATH [US]; Jianming YU [US]; Tyler MANN [US]; In Jong KIM [US]; Xiben LI [US]; Robert LEON [US]; NGUYEN, Long [US]
- (74) **Agente/apoderado:** GONZALO FERNÁNDEZ SECCO (34)
- (54) **Título:** COMPUESTOS HETEROCÍCLICOS ANTIVIRALES

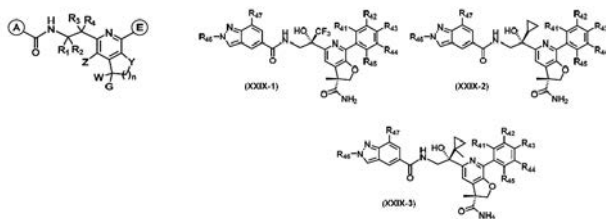

- (57) **Resumen:** La presente invención revela compuestos de Fórmula (I), o sales, ésteres o profármacos de uso farmacéutico aceptable de los mismos, que inhiben al virus sincicial respiratorio humano (HRSV) o los inhibidores del metapneumovirus humano (HMPV). La presente invención se refiere además a composiciones farmacéuticas que comprenden los compuestos mencionados para su administración a un sujeto que sufre una infección por HRSV o HMPV. La invención también se refiere a métodos para tratar una infección por HRSV o HMPV en un sujeto mediante la administración de una composición farmacéutica que comprende los compuestos de la presente invención.

**(19) Dirección Nacional de la Propiedad Industrial – URUGUAY****(12) Invención****(11) UY a/ 039644**

- (51) **Clasificación Internacional:** A 01N 25/22, 25/30, 43/824  
// A 01P 7/00, 9/00
- (22) **Fecha de presentación:** 24/02/2022
- (30) **Datos de prioridad:** 21160052.3 01/03/2021 EP
- (71) **Solicitante:** SYNGENTA CROP PROTECTION AG [CH]
- (72) **Inventor:** VARSHNEY, Manoj [US]; WILLIARD, Elizabeth Gray [US]; MILN, Colin Douglas [US]
- (74) **Agente/apoderado:** JUAN LAPENNE DE SALTERAIN (211)
- (54) **Título:** COMPOSICIONES CON ACTIVIDAD PLAGUICIDA QUE COMPRENDEN TIAMETOXAM Y SU USO PARA CONTROLAR PLAGAS ANIMALES EN CAMPOS DE CULTIVO

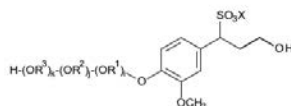
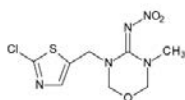

- (57) **Resumen:** La presente invención se refiere a composiciones con actividad plaguicida, en particular con actividad insecticida, que comprenden tiametoxam, y a su uso para controlar plagas animales en campos de cultivo.

**(19) Dirección Nacional de la Propiedad Industrial – URUGUAY****(12) Invención****(11) UY a/ 039645**

- (51) Clasificación Internacional:** C 12N 1/20, A 01H 5/00, 5/10, A 01N 63/02  
**(22) Fecha de presentación:** 24/02/2022  
**(30) Datos de prioridad:** 2021900518 25/02/2021 AU  
**(71) Solicitante:** AGRICULTURE VICTORIA SERVICES PTY LTD [AU]  
**(72) Inventor:** SPANGENBERG, German Carlos [AU]; LI, Tongda [CN]; KAUR, Jatinder [IN]; HONE, Holly [AU]; VAN ESSEN, Rens [NL]; MANN, Ross C [NL]; SAWBRIDGE, Timothy Ivor [UK]  
**(74) Agente/apoderado:** GONZALO FERNÁNDEZ SECCO (34)  
**(54) Título:** BACTERIAS QUE CONFIEREN PROPIEDADES BIOPROTECTORAS Y/O BIOFERTILIZANTES

- (57) Resumen:** La presente invención se refiere a bacterias que confieren propiedades bioprotectoras y/o biofertilizantes a las plantas en las que son inoculadas. Más particularmente, la presente invención se refiere a cepas endófitas de *Paenibacillus* sp., plantas infectadas con tales cepas y métodos relacionados.

**(19) Dirección Nacional de la Propiedad Industrial – URUGUAY****(12) Invención****(11) UY a/ 039647**

- (51) **Clasificación Internacional:** C 07C 251/24, 251/48, 69/614, C 07D 213/26, 231/12, 277/22, 333/28, A 01N 37/36, 37/44, 43/10, 43/40, 43/56, 43/78, A 61K 31/216, 31/381, 31/415, 31/426, 31/4418  
// A 01P 3/00, 7/02, 7/04
- (22) **Fecha de presentación:** 25/02/2022
- (30) **Datos de prioridad:** 2021-029651 26/02/2021 JP y 2021-124464 29/07/2021 JP
- (71) **Solicitante:** SUMITOMO CHEMICAL COMPANY, LIMITED [JP]
- (72) **Inventor:** Keisuke ARAI [JP]
- (74) **Agente/apoderado:** GUSTAVO LARROSA DE BRUN (179)
- (54) **Título:** DERIVADO DE ÁCIDO FENILACÉTICO, USO E INTERMEDIO DE PRODUCCIÓN DEL MISMO

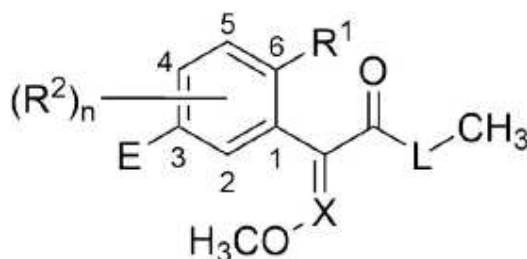

- (57) **Resumen:** La presente invención proporciona un compuesto representado por la fórmula (I), en donde una combinación de X y L representa una combinación en donde X representa un átomo de nitrógeno y L representa un átomo de oxígeno o NH, etc., n es 1 o 2, E representa un grupo arilo C6-C10, etc., R1 y R2 son idénticos o diferentes entre sí y cada uno representa un grupo hidrocarburo de cadena C1-C3 que puede estar opcionalmente sustituido por uno o más halógenos, etc.] tiene una excelente eficacia de control contra plagas, o su N-óxido o sales del mismo.

**(19) Dirección Nacional de la Propiedad Industrial – URUGUAY****(12) Invención****(11) UY a/ 039648**

- (51) Clasificación Internacional:** C 08B 15/06, D 01F 2/28  
**(22) Fecha de presentación:** 25/02/2022  
**(30) Datos de prioridad:** 20215213 26/02/2021 FI  
**(71) Solicitante:** Infinited Fiber Company Oy [FI]  
**(72) Inventor:** MALANIN, Erkki [FI]; MAKELA, Jani [FI]; SIREN, Sakari [FI]; STJERNBERG, Martin [FI]; HARLIN, Ali [FI]  
**(74) Agente/apoderado:** SUSANA DEL CERRO (136)  
**(54) Título:** METODO PARA LA PRODUCCION DE CARBAMATO DE CELULOSA

- (57) Resumen:** Se divulga un método para la producción de carbamato de celulosa en fase acuosa que comprende los pasos de: a) disponer de materia prima de celulosa; b) disponer de urea; c) mezclar celulosa y urea para obtener una mezcla; d) someter la mezcla a una presión reducida de no más de 350 mbar(a); e) calentar la mezcla hasta una temperatura de 130 a 150°C para someter a la celulosa a una reacción con la urea para formar carbamato de celulosa; f) liberar la presión; g) recuperar el carbamato de celulosa, y h) lavar el carbamato de celulosa con agua.

**(19) Dirección Nacional de la Propiedad Industrial – URUGUAY****(12) Invención****(11) UY a/ 039649**

- (51) **Clasificación Internacional:** C 07D 403/06, A 61K 31/4196, C 07D 207/26  
// A 61P 25/28
- (22) **Fecha de presentación:** 25/02/2022
- (30) **Datos de prioridad:** EP21159595.4 26/02/2021 EP
- (71) **Solicitante:** SYNDESI THERAPEUTICS SA [BE]
- (72) **Inventor:** Jonathan SAVIDGE [GB]; John KEMP [GB]; Andrea CESURA [IT]
- (74) **Agente/apoderado:** GUSTAVO LARROSA DE BRUN (179)
- (54) **Título:** COMPUESTO PARA EL TRATAMIENTO DE TRASTORNOS COGNITIVOS

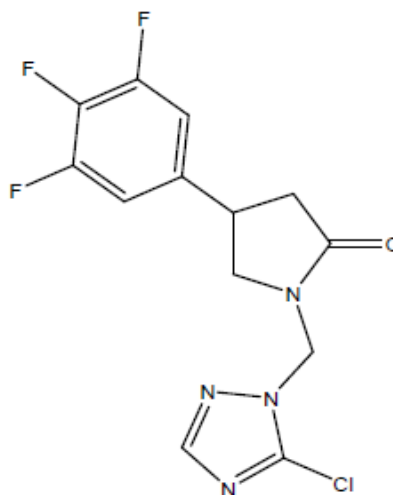

- (57) **Resumen:** La invención se refiere a la administración en dosis particulares de un compuesto que es un 2-oxo-1-pirrolidinil triazol sustituido de fórmula (I) o un isómero o una sal farmacéuticamente aceptable del mismo.

**(19) Dirección Nacional de la Propiedad Industrial – URUGUAY****(12) Invención****(11) UY a/ 039650**

- (51) Clasificación Internacional:** C 12Q 1/68, A 01H 1/00, C 12N 15/11, 15/82  
**(22) Fecha de presentación:** 25/02/2022  
**(30) Datos de prioridad:** 63/153,473 25/02/2021 US  
**(71) Solicitante:** Pairwise Plants Services, Inc. [US]  
**(72) Inventor:** Marisa Miller [US]; Julius Mojica [US]; Haejin Kim [KR]  
**(74) Agente/apoderado:** JUAN LAPENNE DE SALTERAIN (211)  
**(54) Título:** MÉTODOS Y COMPOSICIONES PARA MODIFICAR LA ARQUITECTURA RADICULAR EN PLANTAS

- (57) Resumen:** Esta invención se refiere a composiciones y métodos para modificar la arquitectura radicular en una planta a través de la modificación de ácidos nucleicos DEEPER ROOTING 1 (DRO1) endógenos. La invención se refiere además a plantas producidas usando los métodos y las composiciones de la invención.

**(19) Dirección Nacional de la Propiedad Industrial – URUGUAY****(12) Invención****(11) UY a/ 039651**

- (51) Clasificación Internacional: F 16J 15/40, 9/00  
(22) Fecha de presentación: 25/02/2022  
(30) Datos de prioridad: BR 10 2021 003933-7 02/03/2021 BR  
(71) Solicitante: MIGUEL DELL'AGLI [BR]  
(72) Inventor: MIGUEL DELL'AGLI [BR]  
(74) Agente/apoderado: STELLA MARINA WENG POLICICCHIO (218)  
(54) Título: CONJUNTO BRIDA Y COLLAR DE ESTANQUEIDAD

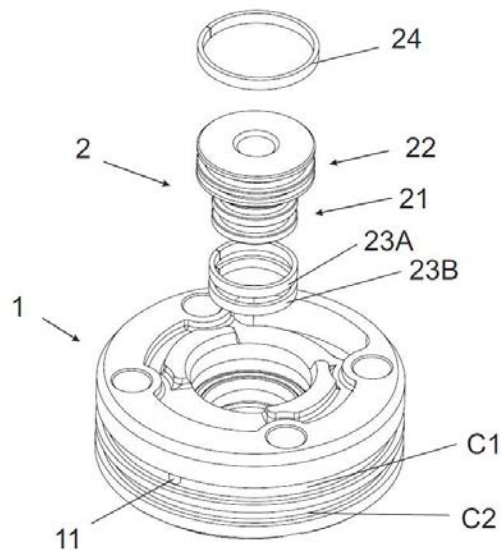

- (57) Resumen: En el que el collar de estanqueidad está montado en el interior de la brida, donde el collar de estanqueidad tiene una porción frontal con diámetro menor que la porción posterior y dos anillos de pistón en la porción anterior. La brida tiene un canal de comunicación que interconecta la porción media entre los anillos de pistón del collar de estanqueidad con el colector de escape acoplado junto al sistema turboalimentado. La presión positiva proveniente del colector de escape impide el retorno del aceite lubricante al compresor del sistema turboalimentado



**(19) Dirección Nacional de la Propiedad Industrial – URUGUAY****(12) Invención****(11) UY a/ 039653**

- (51) **Clasificación Internacional:** C 07D 209/04, A 01N 43/38, A 61K 31/404, C 07C 69/74  
// A 61P 7/04
- (22) **Fecha de presentación:** 03/03/2022
- (30) **Datos de prioridad:** 2021-035003 05/03/2021 JP y 2021-124552 29/07/2021 JP
- (71) **Solicitante:** SUMITOMO CHEMICAL COMPANY, LIMITED [JP]
- (72) **Inventor:** Yoshihiko NOKURA [JP]
- (74) **Agente/apoderado:** GUSTAVO LARROSA DE BRUN (179)
- (54) **Título:** COMPUESTO DE ANILLO CONDENSADO Y USO DEL MISMO.

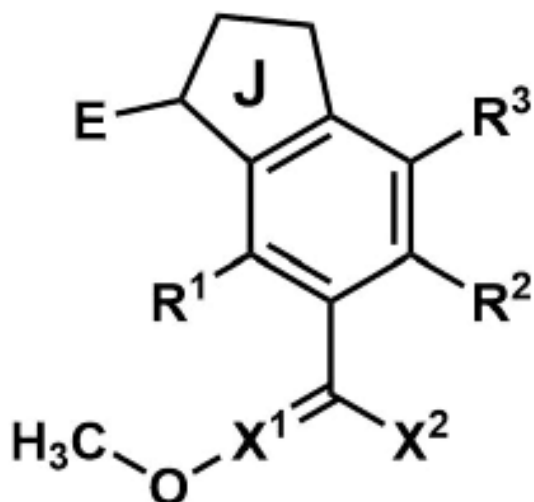

- (57) **Resumen:** Compuesto de anillo condensado y uso del mismo, representado por la fórmula (I) que tiene una excelente eficacia de control contra las plagas.

**(19) Dirección Nacional de la Propiedad Industrial – URUGUAY****(12) Invención****(11) UY a/ 039654**

- (51) Clasificación Internacional:** A 01N 59/00, 59/06, 43/16, C 01C 1/26  
**(22) Fecha de presentación:** 03/03/2022  
**(30) Datos de prioridad:** P20210100807 30/03/2021 AR  
**(71) Solicitante:** NUÑEZ MARÍA INÉS [AR]  
**(72) Inventor:** WOLF FELIPE [AR]  
**(74) Agente/apoderado:** Juan Eduardo Vanrell Falcon (144)  
**(54) Título:** COMPOSICION PARA EL SECADO DE TILLANDSIA sp

- (57) Resumen:** Comprende en solución acuosa un componente principal elegido por lo menos entre el bicarbonato de sodio ( $\text{NaHCO}_3$ ), el bicarbonato de amonio ( $\text{NH}_4\text{HCO}_3$ ) e hidróxido de calcio por un total solo o combinados con el bicarbonato 5 de sodio de 0,045 gr./ cm<sup>3</sup> de solución acuosa hasta 0,10 gr./cm<sup>3</sup> de solución acuosa y 0,30 cm<sup>3</sup> de solución hidroalcohólica de ácido Carminico hasta un máximo de 0,80 cm<sup>3</sup>/ cm<sup>3</sup> de solución acuosa.

**(19) Dirección Nacional de la Propiedad Industrial – URUGUAY****(12) Invención****(11) UY a/ 039655**

- (51) **Clasificación Internacional:** D 06B 15/10, G 01N 1/28, 30/72, D 06B 9/00  
(22) **Fecha de presentación:** 03/03/2022  
(30) **Datos de prioridad:** 773526 03/03/2021 NZ  
(71) **Solicitante:** Oritain Global Limited [NZ]  
(72) **Inventor:** Russell David FREW [NZ]  
(74) **Agente/apoderado:** Gustavo Fischer Fleurquin (94)  
(54) **Título:** SEPARACIÓN QUÍMICA DE FIBRAS SINTÉTICAS DE UNA MEZCLA DE FIBRAS SINTÉTICAS Y FIBRAS SEMISINTÉTICAS O NATURALES

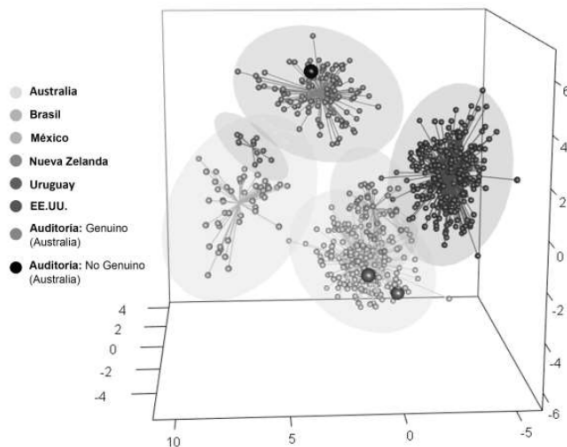

- (57) **Resumen:** Un método para separar las fibras sintéticas de una mezcla de fibras sintéticas y fibras semisintéticas o naturales, manteniendo al mismo tiempo la integridad del material de las fibras semisintéticas o naturales para su análisis a fin de determinar el origen de la fibra mediante el análisis de isótopos estables o la determinación de las concentraciones de oligoelementos, o ambos, y comparar los datos con los de las fibras de origen conocido.

**(19) Dirección Nacional de la Propiedad Industrial – URUGUAY****(12) Invención****(11) UY a/ 039656**

- (51) Clasificación Internacional:** A 01N 57/20, C 07F 9/30  
**(22) Fecha de presentación:** 03/03/2022  
**(30) Datos de prioridad:** 202121009174 04/03/2021 IN  
**(71) Solicitante:** UPL LIMITED [IN]  
**(72) Inventor:** MONDAL, Achintya [IN]; BHOGE, Satish Ekanath [IN]  
**(74) Agente/apoderado:** GUSTAVO LARROSA DE BRUN (179)  
**(54) Título:** PROCESO PARA PRODUCIR UNA COMPOSICIÓN HERBICIDA LIQUIDA.

- (57) Resumen:** La presente invención se refiere a un proceso mejorado para producir una composición herbicida líquida de un único isómero de sal de glufosinato y/o sales agronómicamente aceptables del mismo.

**(19) Dirección Nacional de la Propiedad Industrial – URUGUAY****(12) Invención****(11) UY a/ 039657**

---

- (51) **Clasificación Internacional:** A 01N 57/20, C 07F 9/11, 9/30  
(22) **Fecha de presentación:** 04/03/2022  
(30) **Datos de prioridad:** 202121009175 04/03/2021 IN  
(71) **Solicitante:** UPL LIMITED [IN]  
(72) **Inventor:** MONDAL, Achintya [IN]; BHOGE, Satish Ekanath [IN]  
(74) **Agente/apoderado:** GUSTAVO LARROSA DE BRUN (179)  
(54) **Título:** COMPOSICIONES HERBICIDAS LÍQUIDAS

- (57) **Resumen:** En el presente documento, se divulga una composición agroquímica líquida. También se divulga un proceso de preparación de la composición agroquímica líquida, el uso de las composiciones líquidas para el control de las malas hierbas y un método de control de las malas hierbas que usa la composición agroquímica líquida.

**(19) Dirección Nacional de la Propiedad Industrial – URUGUAY****(12) Invención****(11) UY a/ 039658**

- (51) Clasificación Internacional:** A 61K 31/18, 31/64, C 07C 311/16, 311/57, 311/59  
// A 61P 25/00, 3/10, 9/10, 9/14
- (22) Fecha de presentación:** 04/03/2022
- (30) Datos de prioridad:** 63/156,533 04/03/2021 US
- (71) Solicitante:** Biogen Chesapeake LLC [US]
- (72) Inventor:** TRAN, KENNY K. [US]; LOWE, DEIRDRE [US]; SAWANT, RUPA RISHIKESH [US]; CHEN, HAIHONG [US]; LIN, YIQING [US]
- (74) Agente/apoderado:** AGUSTÍ N MAYER WEST (205)
- (54) Título:** FORMULACIÓN Y MÉTODOS DE GLIBURIDA DE BAJA ABSORCIÓN
- (57) Resumen:** Métodos y formulaciones para minimizar o evitar la sorción de gliburida en las superficies de los tubos de suministro, filtros, bolsas y otros recipientes y materiales, almacenando y suministrando así un producto más estable, suministrando una dosis predecible y precisa de la gliburida, al tiempo que minimiza las impurezas, evita el desperdicio de medicamentos, reduce los costos y reduce significativamente la cantidad de solución de dosificación (generalmente solución salina o solución de Ringer) que se debe infundir al paciente.

**(19) Dirección Nacional de la Propiedad Industrial – URUGUAY****(12) Invención****(11) UY a/ 039659**

- (51) Clasificación Internacional:** C 12N 15/11, 15/85, 7/01, A 61K 35/76, 35/761, 48/00 // A 61P 7/04
- (22) Fecha de presentación:** 07/03/2022
- (30) Datos de prioridad:** 2021105703 05/03/2021 RU
- (71) Solicitante:** Limited Liability Company «ANABION» [RU]
- (72) Inventor:** Morozov Dmitry Valentinovich [RU]; Gershovich Pavel Mikhailovich [RU]; Shugaeva Tatiana Evgenievna [RU]; Prokofyev Alexander Vladimirovich [RU]; Strelkova Anna Nikolaevna [RU]; Spirina Natalia Aleksandrovna [RU]
- (74) Agente/apoderado:** GONZALO FERNÁNDEZ SECCO (34)
- (54) Título:** ÁCIDO NUCLEICO OPTIMIZADO POR CODONES QUE CODIFICA LA PROTEÍNA DEL FACTOR DE COAGULACIÓN IX Y SU USO

- (57) Resumen:** La presente solicitud está relacionada con los campos de la genética, la terapia génica y la biología molecular. Más específicamente, la presente invención se refiere a un ácido nucleico aislado optimizado en codones que codifica la proteína FIX (factor de coagulación IX), un casete de expresión y un vector basado en el mismo, así como un virus recombinante basado en el AAV5 (virus adenoasociado de serotipo 5) para aumentar la expresión del gen FIX en las células diana, y su uso.

**(19) Dirección Nacional de la Propiedad Industrial – URUGUAY****(12) Invención****(11) UY a/ 039662**

- (51) **Clasificación Internacional:** C 07D 401/14, 403/14, 405/14, 413/14, 417/14, 487/04, 487/10, 491/08, 491/107, 495/10, A 61K 31/517  
// A 61P 35/00
- (22) **Fecha de presentación:** 09/03/2022
- (30) **Datos de prioridad:** 63/158,998 10/03/2021 US
- (71) **Solicitante:** BLUEPRINT MEDICINES CORPORATION [US]
- (72) **Inventor:** Meredith Suzanne ENO [US]; Thomas A. DINEEN [US]; John Emerson CAMPBELL [US]; Omar AHMAD [US]; Dilinie Prasadhini FERNANDO [US]
- (74) **Agente/apoderado:** FABIANA PENADES (216)
- (54) **Título:** INHIBIDORES DE EGFR

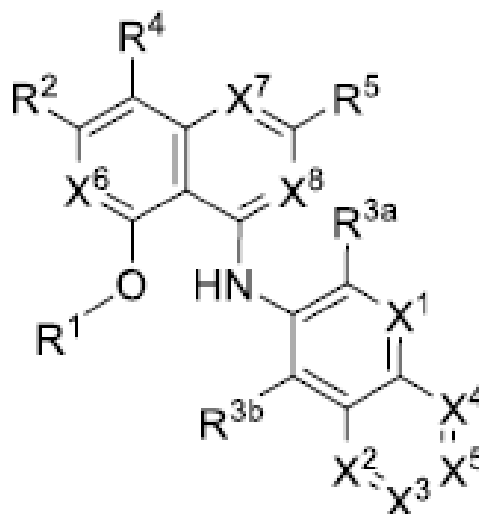

- (57) **Resumen:** La presente divulgación proporciona un compuesto representado por la fórmula estructural (I-0) o una sal farmacéuticamente aceptable de este útil para tratar un cáncer.



**(19) Dirección Nacional de la Propiedad Industrial – URUGUAY****(12) Invención****(11) UY a/ 039663**

- (51) **Clasificación Internacional:** A 01N 57/20, C 07F 9/30, A 01P 13/00  
(22) **Fecha de presentación:** 10/03/2022  
(30) **Datos de prioridad:** 202121046318 11/10/2021 IN  
(71) **Solicitante:** UPL LIMITED [IN]  
(72) **Inventor:** LENZ, Giuvan [BR]; RAO, Ganesh [IN]  
(74) **Agente/apoderado:** GUSTAVO LARROSA DE BRUN (179)  
(54) **Título:** MÉTODO PARA CONTROLAR EL CRECIMIENTO DE VEGETACIÓN NO DESEABLE

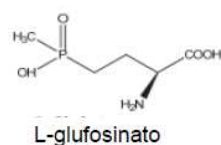
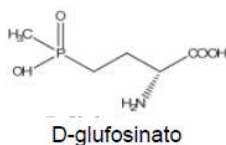

- (57) **Resumen:** Se describe en el presente documento un método para controlar el crecimiento de vegetación no deseable, mala hierba de Eleusine indica, incluyendo el método tratar el emplazamiento en el que se desea el control con una composición sinérgica que incluye combinaciones de glufosinato.

**(19) Dirección Nacional de la Propiedad Industrial – URUGUAY****(12) Invención****(11) UY a/ 039664**

- (51) **Clasificación Internacional:** A 01N 57/20, C 07F 9/30, A 01P 13/00  
(22) **Fecha de presentación:** 10/03/2022  
(30) **Datos de prioridad:** 202121045719 07/10/2021 IN  
(71) **Solicitante:** UPL LIMITED [IN]  
(72) **Inventor:** RAO, Ganesh [IN]; LENZ, Giuvan [BR]  
(74) **Agente/apoderado:** GUSTAVO LARROSA DE BRUN (179)  
(54) **Título:** MÉTODO PARA CONTROLAR EL CRECIMIENTO DE VEGETACIÓN NO DESEABLE

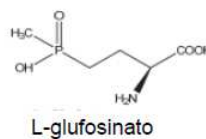
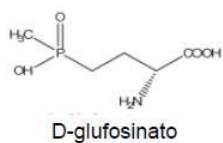

- (57) **Resumen:** En el presente documento se describe un método para controlar el crecimiento de vegetación no deseable mala hierba de Glycine max, incluyendo el método tratar el emplazamiento en el que se desea el control con una composición sinérgica que incluye combinaciones de glufosinato.

**(19) Dirección Nacional de la Propiedad Industrial – URUGUAY****(12) Invención****(11) UY a/ 039665**

- (51) **Clasificación Internacional:** A 01N 57/20, C 07F 9/30, A 01P 13/00  
(22) **Fecha de presentación:** 10/03/2022  
(30) **Datos de prioridad:** 202121046312 11/10/2021 IN  
(71) **Solicitante:** UPL LIMITED [IN]  
(72) **Inventor:** LENZ, Giuvan [BR]; RAO, Ganesh [IN]  
(74) **Agente/apoderado:** GUSTAVO LARROSA DE BRUN (179)  
(54) **Título:** MÉTODO PARA CONTROLAR EL CRECIMIENTO DE VEGETACIÓN NO DESEABLE

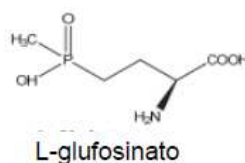
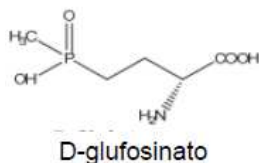

- (57) **Resumen:** Se describe en el presente documento un método para controlar el crecimiento de vegetación no deseable, mala hierba de *Spermacoce latifolia*, incluyendo el método tratar el emplazamiento en el que se desea el control con una composición sinérgica que incluye combinaciones de glufosinato.

**(19) Dirección Nacional de la Propiedad Industrial – URUGUAY****(12) Invención****(11) UY a/ 039666**

- (51) **Clasificación Internacional:** A 01N 57/20, C 07F 9/30, A 01P 13/00  
(22) **Fecha de presentación:** 10/03/2022  
(30) **Datos de prioridad:** 202121046316 11/10/2021 IN  
(71) **Solicitante:** UPL LIMITED [IN]  
(72) **Inventor:** LENZ, Giuvan [BR]; RAO, Ganesh [IN]  
(74) **Agente/apoderado:** GUSTAVO LARROSA DE BRUN (179)  
(54) **Título:** MÉTODO PARA CONTROLAR EL CRECIMIENTO DE VEGETACIÓN NO DESEABLE

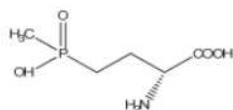

D-glufosinato

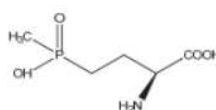

L-glufosinato

- (57) **Resumen:** Se describe en el presente documento un método para controlar el crecimiento de vegetación no deseable, mala hierba de *Brachiaria decumbens*, incluyendo el método tratar el emplazamiento en el que se desea el control con una composición sinérgica que incluye combinaciones de glufosinato.

**(19) Dirección Nacional de la Propiedad Industrial – URUGUAY****(12) Invención****(11) UY a/ 039669**

- (51) Clasificación Internacional:** C 07K 16/18, 19/00, A 61K 39/395, C 12N 15/11, 15/85, 5/10  
// A 61P 37/02
- (22) Fecha de presentación:** 11/03/2022
- (30) Datos de prioridad:** 63/160,127 12/03/2021 US y 63/252,910 06/10/2021 US
- (71) Solicitante:** JANSSEN BIOTECH, INC. [US]
- (72) Inventor:** Fang Shen [US]; Songmao Zheng [CN]; John Emery [US]; Jennifer F. Nemeth [US]; Pankaj Seth [US]
- (74) Agente/apoderado:** DIEGO DUFRECHU RODRIGUEZ (192)
- (54) Título:** USOS DE ANTICUERPOS CD79B PARA APLICACIONES TERAPÉUTICAS AUTOINMUNITARIAS

- (57) Resumen:** La invención proporciona dominios de unión que se unen a la proteína del cúmulo de diferenciación 79b (cd79b), que comprende los dominios de unión al antígeno que se unen a cd79b, polinucleótidos que los codifican, vectores, células huésped, métodos de preparación y uso de estos.

**(19) Dirección Nacional de la Propiedad Industrial – URUGUAY****(12) Invención****(11) UY a/ 039677**

- (51) **Clasificación Internacional:** B 65D 49/12, 77/38, G 09F 3/02  
(22) **Fecha de presentación:** 17/03/2022  
(30) **Datos de prioridad:** 2021900779 17/03/2021 AU  
(71) **Solicitante:** KILCOY PASTORAL COMPANY LIMITED [AU]  
(72) **Inventor:** Jarrod Teale [AU]; Nigel Adler [AU]  
(74) **Agente/apoderado:** GONZALO FERNÁNDEZ SECCO (34)  
(54) **Título:** PROCEDIMIENTO DE CONFORMIDAD DE EMPAQUETADO

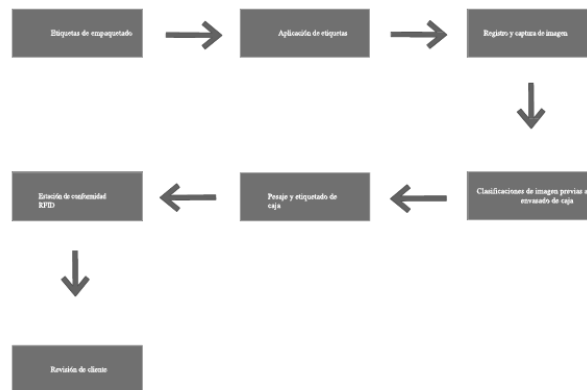

- (57) **Resumen:** Un método de cumplimiento del embalaje para garantizar que dentro de un recipiente se encuentran el número y el tipo correctos de producto. Hay situadas etiquetas únicas sobre el producto y sobre el recipiente. Las etiquetas únicas sobre el producto se leen una vez en el recipiente y se comparan con el contenido especificado en las etiquetas únicas sobre el recipiente. Se rechaza o se acepta el recipiente en función de la comparación.

**(19) Dirección Nacional de la Propiedad Industrial – URUGUAY****(12) Invención****(11) UY a/ 039682**

- (51) **Clasificación Internacional:** B 67D 1/04  
(22) **Fecha de presentación:** 22/03/2022  
(30) **Datos de prioridad:** BR102021005420-4 22/03/2021 BR  
(71) **Solicitante:** AMBEV S/A. [BR]  
(72) **Inventor:** Mateus Vieira Cunha [BR]; José Virgílio Braghetto Neto [BR]  
(74) **Agente/apoderado:** Juan Eduardo Vanrell Falcon (144)  
(54) **Título:** CONJUNTO DE PRESURIZACIÓN DE BEBIDAS Y SISTEMA DE PRESURIZACIÓN Y DISPENSACIÓN EN UN ENVASE DE BEBIDAS

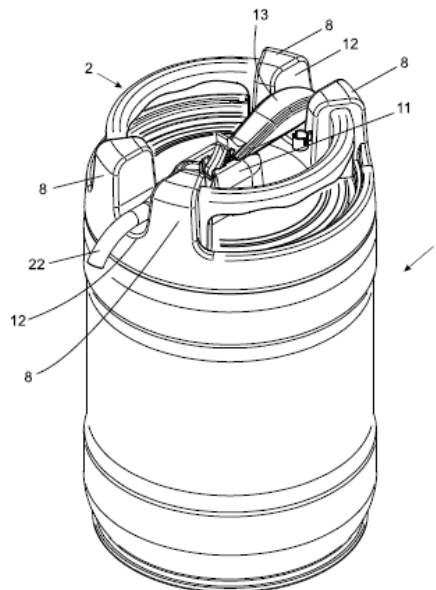

- (57) **Resumen:** Conjunto de presurización de bebidas acoplable a un recipiente de bebida, que comprende un regulador de presión acoplable a una superficie superior del recipiente, el regulador de presión comprende un cartucho de co2 y una válvula reguladora; una manopla pivotante operativamente acoplable al botón de accionamiento en la región de la superficie superior del recipiente de bebida; en donde un pivotado de la manopla en la dirección ascendente causa un accionamiento del botón de accionamiento de la válvula y liberación de co2 a través de la salida de co2 del cartucho.

**(19) Dirección Nacional de la Propiedad Industrial – URUGUAY****(12) Invención****(11) UY a/ 039683**

- (51) Clasificación Internacional:** C 07K 16/18, 16/28, 19/00, A 61K 39/395, C 12N 15/11, 15/85, 5/10  
// A 61P 37/02
- (22) Fecha de presentación:** 23/03/2022
- (30) Datos de prioridad:** 63/165,416 24/03/2021 US
- (71) Solicitante:** JANSSEN BIOTECH, INC. [US]
- (72) Inventor:** Sanjaya Singh [US]; Rajkumar Ganesan [US]; Kyle Bednar [US]; Naresh Kumar [IN]; Danlin Yang [CA]
- (74) Agente/apoderado:** DIEGO DUFRECHU RODRIGUEZ (192)
- (54) Título:** ANTICUERPO DIRIGIDO A CD22 Y CD79B

- (57) Resumen:** En la presente descripción se proporcionan anticuerpos multiespecíficos, que se unen a CD79b y CD22, polinucleótidos que los codifican, vectores, células huésped, métodos para elaborarlos y usarlos.



**(19) Dirección Nacional de la Propiedad Industrial – URUGUAY****(12) Invención****(11) UY a/ 039685**

- (51) Clasificación Internacional:** C 07K 16/18, 16/28, 19/00, C 12N 15/11, 5/10, A 61K 39/395  
// A 61P 35/00
- (22) Fecha de presentación:** 24/03/2022
- (30) Datos de prioridad:** 63/165.501 24/03/2021 US y 63/286.309 06/12/2021 US
- (71) Solicitante:** Janssen Pharmaceutica NV [BE]
- (72) Inventor:** Sanjaya Singh [US]; Ulrike Philippar [DE]; Rajkumar Ganesan [US]; Danlin Yang [CA]; Anna Kuchnio [PL]; Cassandra L. Lowenstein [US]; Nele Vloemans [BE]
- (74) Agente/apoderado:** DIEGO DUFRECHU RODRIGUEZ (192)
- (54) Título:** ANTICUERPO TRIESPECÍFICO DIRIGIDO A CD79B, CD20, Y CD3

- (57) Resumen:** En el presente documento se proporcionan anticuerpos multiespecíficos, que incluyen anticuerpos triespecíficos que se unen a cd79b, cd20 y cd3, y anticuerpos biespecíficos que se unen a cd79b y cd3, y fragmentos de unión a antígeno multiespecíficos de los mismos. También se describen polinucleótidos relacionados capaces de codificar los anticuerpos multiespecíficos o fragmentos de unión a antígeno multiespecíficos proporcionados, células que expresan los anticuerpos multiespecíficos o fragmentos de unión a antígeno multiespecíficos proporcionados, así como vectores asociados y anticuerpos multiespecíficos o fragmentos de unión a antígeno multiespecíficos marcados de forma detectable.

## (19) Dirección Nacional de la Propiedad Industrial – URUGUAY

(12) Invención

(11) UY a/ 039689

- (51) **Clasificación Internacional:** A 61K 38/38  
// A 61P 7/00
- (22) **Fecha de presentación:** 25/03/2022
- (30) **Datos de prioridad:** 21382248.9 25/03/2021 EP y 21382481.6 27/05/2021 EP
- (71) **Solicitante:** GRIFOLS WORLDWIDE OPERATIONS LIMITED [IE] y EUROPEAN FOUNDATION FOR THE STUDY OF CHRONIC LIVER FAILURE (EF-CLIF) [ES]
- (72) **Inventor:** NUÑEZ DOMENECH LAURA [ES]; ARROYO PEREZ VICENTE [ES]; MOREAU RICHARD [FR]; CLARIA ENRICH JOAN [ES]; FERNANDEZ GOMEZ JAVIER [ES]; HERRILLO SAURA RAQUEL [ES]
- (74) **Agente/apoderado:** Juan Eduardo Vanrell Falcon (144)
- (54) **Título:** USO DE ALBÚMINA PARA EL TRATAMIENTO DE LA FUNCIÓN DEFECTUOSA DE LOS LINFOCITOS B

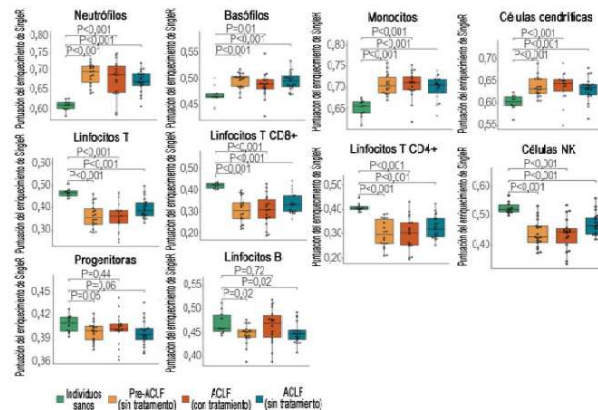

- (57) **Resumen:** La presente invención se refiere a una composición que comprende albúmina humana para regular la función de los linfocitos b en un paciente que padece el síndrome de respuesta inflamatoria sistémica, en la que la albúmina se administra al paciente en una dosis suficiente para aumentar la densidad del receptor de linfocitos b en una población de linfocitos b.

**(19) Dirección Nacional de la Propiedad Industrial – URUGUAY****(12) Invención****(11) UY a/ 039698**

- (51) Clasificación Internacional:** C 07K 16/18, 16/46, C 12N 15/11, 15/85, 5/10, C 12P 21/08, A 61K 39/395  
// A 61P 25/00, 25/28
- (22) Fecha de presentación:** 28/03/2022
- (30) Datos de prioridad:** 63/166,524 26/03/2021 US y 63/269,225 11/03/2022 US
- (71) Solicitante:** JANSSEN BIOTECH, INC. [US]
- (72) Inventor:** Rupesh Nanjunda [US]; Partha Chowdhury [US]; Fern Sha [US]
- (74) Agente/apoderado:** DIEGO DUFRECHU RODRIGUEZ (192)
- (54) Título:** ANTICUERPOS HUMANIZADOS CONTRA EL FILAMENTO HELICOIDAL EMPAREJADO TAU Y USOS DE ESTOS

- (57) Resumen:** Se describen anticuerpos humanizados anti-phf-tau y fragmentos de unión al antígeno de estos. También se describen ácidos nucleicos que codifican los anticuerpos, conjugados y constructos de fusión de los anticuerpos, composiciones que comprenden los anticuerpos, métodos para producir los anticuerpos y usar los anticuerpos para tratar o prevenir afecciones tales como tauopatías.

**(19) Dirección Nacional de la Propiedad Industrial – URUGUAY****(12) Invención****(11) UY a/ 039699**

- (51) Clasificación Internacional:** C 07K 16/18, C 12N 15/11, 15/85, 5/10, A 61K 39/395, C 12P 21/08  
// A 61P 25/00, 25/28
- (22) Fecha de presentación:** 28/03/2022
- (30) Datos de prioridad:** 63/166,439 26/03/2021 US y 63/196,365 03/06/2021 US
- (71) Solicitante:** JANSSEN BIOTECH, INC. [US]
- (72) Inventor:** Rupesh Nanjunda [US]; Kristof Van Kolen [US]
- (74) Agente/apoderado:** DIEGO DUFRECHU RODRIGUEZ (192)
- (54) Título:** ANTICUERPOS ANTI-TAU Y USOS DE ESTOS

- (57) Resumen:** Se describen anticuerpos monoclonales anti-phf-tau y fragmentos de unión al antígeno de estos. También se describen ácidos nucleicos que codifican los anticuerpos, composiciones que comprenden los anticuerpos, métodos para producir los anticuerpos y usar los anticuerpos para tratar o prevenir afecciones, tales como tauopatías.

**(19) Dirección Nacional de la Propiedad Industrial – URUGUAY****(12) Invención****(11) UY a/ 039706**

- (51) **Clasificación Internacional:** C 07D 209/04, 209/30, 209/32, A 61K 31/404 // A 61P 31/14
- (22) **Fecha de presentación:** 06/05/2016
- (30) **Datos de prioridad:** 15166900.9 08/05/2015 EP; 16163342.5 31/03/2016 EP y 36674 06/05/2016 UY
- (71) **Solicitante:** Janssen Pharmaceuticals, Inc. [US] y Katholieke Universiteit Leuven [BE]
- (72) **Inventor:** BARDIOT, Dorothée Alice Marie-Eve [FR]; BONFANTI, Jean-François [FR]; MARCHAND, Arnaud Didier M [FR]; RABOISSON, Pierre Jean-Marie Bernard [FR]; KESTELEYN, Bart Rudolf Romaine [BE]; JONCKERS, Tim Hugo Maria [BE]
- (74) **Agente/apoderado:** DIEGO DUFRECHU RODRIGUEZ (192)
- (54) **Título:** DERIVADOS DE (1H-INDOL- 3-IL)-2-(4-CLORO-2-METOXI-FENIL)-2-((3-METOXI-5-(METILSULFONIL) FENIL)AMINO)ETANONA COMO INHIBIDORES DE LA REPLICACIÓN DEL VIRUS DEL DENGUE

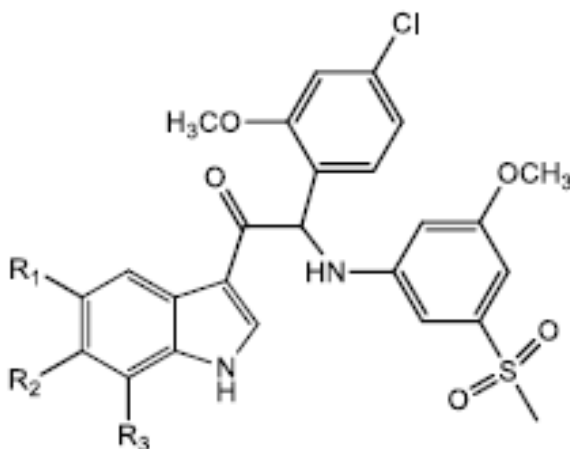

- (57) **Resumen:** Se divulgan derivados de (1H-indol-3-il)-2-(4-cloro-2-metoxi-fenil)-2-((3-metoxi-5-(metilsulfonil)fenil)amino) etanona, métodos para prevenir o tratar infecciones por el virus del dengue usando dichos compuestos como medicamento. La invención se refiere además a composiciones farmacéuticas o preparaciones a partir de combinación de compuestos para uso como medicamento. La invención también se refiere a los procesos de preparación de los compuestos.

**(19) Dirección Nacional de la Propiedad Industrial – URUGUAY****(12) Invención****(11) UY a/ 039710**

- (51) Clasificación Internacional:** C 12N 1/20, 1/21  
**(22) Fecha de presentación:** 31/03/2022  
**(30) Datos de prioridad:** 21166781.1 01/04/2021 EP  
**(71) Solicitante:** Janssen Pharmaceuticals, Inc. [US]  
**(72) Inventor:** Jeroen GEURTSSEN [NL]; Eveline, Marleen WEERDENBURG [NL]; Pieter Jan BURGHOUT [NL]  
**(74) Agente/apoderado:** DIEGO DUFRECHU RODRIGUEZ (192)  
**(54) Título:** PRODUCCIÓN DE BIOCONJUGADOS DE O18 DE E. COLI

- (57) Resumen:** La invención se refiere a células hospedadoras para producir un bioconjugado de un polisacárido del antígeno o18 de e. Coli conjugado con una proteína portadora. Dichas células comprenden polimerasas del antígeno o wzy modificadas mejoran el rendimiento y el patrón de glucosilación de los bioconjugados de o18 producidos por las células hospedadoras. Se divulgan métodos para producir un bioconjugado de un polisacárido del antígeno o18 de e. Coli conjugado con una proteína portadora, y composiciones que los comprenden incluidas composiciones multivalentes

**(19) Dirección Nacional de la Propiedad Industrial – URUGUAY****(12) Invención****(11) UY a/ 039847**

- (51) **Clasificación Internacional:** C 07C 67/00, 69/78  
(22) **Fecha de presentación:** 12/03/2014  
(30) **Datos de prioridad:** 61/780,621 13/03/2013 US; 61/947,850 04/03/2014 US y 35394 12/03/2014 UY  
(71) **Solicitante:** AbbVie Ireland Unlimited Company [IE]  
(72) **Inventor:** Jufang Barkalow [US]; Jean- Christophe Califano [US]; Vicent S. Chan [US]; Alan C. Christesen [US]; Timothy A Grieme [US]; Yi-Yin-Ku [US]; Mathew M. Mulhern [US]; Yu-Ming M.Pu [US]  
(74) **Agente/apoderado:** AGUSTÍ N MAYER WEST (205)  
(54) **Título:** PROCESOS PARA LA PREPARACIÓN DE UN AGENTE INDUCTOR DE LA APOPTOSIS

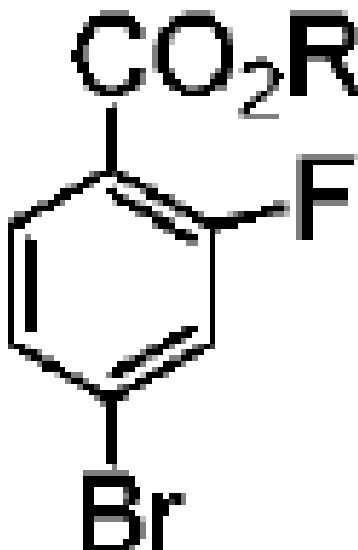

- (57) **Resumen:** Un proceso para la preparación de un agente inductor de la apoptosis, y sustancias químicas intermediarias del mismo. También, novedosas sustancias químicas intermediarias relacionadas con dicho proceso. SOLICITUD DIVISIONAL 35394 de fecha 12/03/2014

**(19) Dirección Nacional de la Propiedad Industrial – URUGUAY****(12) Invención****(11) UY a/ 039848**

- (51) **Clasificación Internacional:** C 07C 67/00, 67/08, C 07D 471/04  
(22) **Fecha de presentación:** 12/03/2014  
(30) **Datos de prioridad:** 35394 12/03/2014 UY  
(71) **Solicitante:** AbbVie Ireland Unlimited Company [IE]  
(72) **Inventor:** Jufang Barkalow [US]; Jean- Christophe Califano [US]; Vicent S. Chan [US]; Alan C. Christesen [US]; Timothy A Grieme [US]; Yi-Yin-Ku [US]; Mathew M. Mulhern [US]; Yu-Ming M.Pu [US]  
(74) **Agente/apoderado:** AGUSTÍ N MAYER WEST (205)  
(54) **Título:** PROCESOS PARA LA PREPARACIÓN DE UN AGENTE INDUCTOR DE LA APOPTOSIS

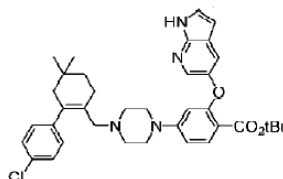
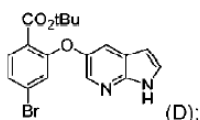

- (57) **Resumen:** Un proceso para la preparación de un agente inductor de la apoptosis, y sustancias químicas intermediarias del mismo. También, novedosas sustancias químicas intermediarias relacionadas con dicho proceso. SOLICITUD DIVISIONAL de 35394 de fecha 12/03/2014



**(19) Dirección Nacional de la Propiedad Industrial – URUGUAY****(12) Invención****(11) UY a/ 039869**

- (51) Clasificación Internacional:** A 01N 43/50, 43/56, 43/653, 59/02, C 07D 231/10, 239/52, 249/12
- (22) Fecha de presentación:** 06/03/2018
- (30) Datos de prioridad:** 201731008009 07/03/2017 IN y 37625 06/03/2018 UY
- (71) Solicitante:** UPL LTD [IN]
- (72) Inventor:** FABRI, CARLOS, EDUARDO [BR]; SHROFF, RAJJU, DEVIDAS [IN]; SHROFF, JAIDEV RAJNIKANT [UK]; SHROFF, VIKRAM RAJNIKANT [UK]
- (74) Agente/apoderado:** VIRGINIA CERVIERI GHIOLDI (212)
- (54) Título:** COMBINACIONES FUNGICIDAS

- (57) Resumen:** La presente invención revela una combinación fungicida que comprende al menos un fungicida de contacto multisitio, un primer fungicida sistémico; y un segundo fungicida sistémico adicional. Esta combinación produce un efecto sinérgico útil para controlar un amplio espectro de enfermedades fúngicas en plantas.

**(19) Dirección Nacional de la Propiedad Industrial – URUGUAY****(12) Invención****(11) UY a/ 039887**

- (51) **Clasificación Internacional:** C 07D 471/04, A 61K 31/4353, 31/506, 31/53, C 07D 403/14  
// A 61P 37/00
- (22) **Fecha de presentación:** 08/08/2022
- (30) **Datos de prioridad:** 61/786,260 14/03/2013 US
- (71) **Solicitante:** Janssen Pharmaceutica NV [BE]
- (72) **Inventor:** Christa C. CHROVIAN [US]; Curt A. DVORAK [US]; Christine F. GELIN [US]; Neelakandha S. MANI [US]; Manuel Jesús ALCAZAR VACA [ES]; Brett D. ALLISON [US]; Jose Ignacio ANDRES GIL [ES]; Heather Renee COATE [US]; Meri DE ANGELIS [IT]; Xiaohu DENG [CN]; Michael A. LEVATIC [US]; Jimmy T. LIANG [US]; Jason C. RECH [US]; Brad M. SAVALL [US]; Akinola SOYODE-JOHNSON [NG]; Brice STENNE [CA]; Devin M. SWANSON [US]; Jessica L. WALL [US]
- (74) **Agente/apoderado:** DIEGO DUFRECHU RODRIGUEZ (192)
- (54) **Título:** (R)-(2-CLORO-3-(TRIFLUOROMETIL)FENIL)(1-(5-FLUOROPYRIMIDIN-2-IL)-4-METIL-6,7-DIHI-DRO-1H-[1,2,3]TRIAZOLO-[4,5-C]PIRIDIN-5(4H)-IL)METANONA COMO MODULADOR DEL RECEPTOR P2X7

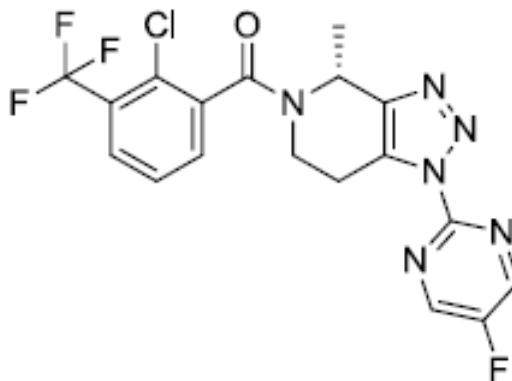

- (57) **Resumen:** La presente invención divulga al compuesto (R)-(2-cloro-3-(trifluorometil)fenil)(1-(5-fluoropirimidin-2-il)-4-metil-6,7-dihidro-1H-[1,2,3]triazolo[4,5-c]piridin-5(4H)-il)metanona y a composiciones farmacéuticas que los comprenden. Dicho compuesto actúa biológicamente como modulador del receptor P2X7.

## (19) Dirección Nacional de la Propiedad Industrial – URUGUAY

(12) Invención

(11) UY a/ 039888

- (51) **Clasificación Internacional:** C 07D 471/04, A 61K 31/437, 31/4427, 31/497, 31/506, C 07D 401/14, 403/14  
// A 61P 37/00
- (22) **Fecha de presentación:** 08/08/2022
- (30) **Datos de prioridad:** 61/786,260 14/03/2013 US
- (71) **Solicitante:** Janssen Pharmaceutica NV [BE]
- (72) **Inventor:** Christa C. CHROVIAN [US]; Curt A. DVORAK [US]; Christine F. GELIN [US]; Neelakandha S. MANI [US]; Manuel Jesús ALCAZAR VACA [ES]; Brett D. ALLISON [US]; Jose Ignacio ANDRES GIL [ES]; Heather Renee COATE [US]; Meri DE ANGELIS [IT]; Xiaohu DENG [CN]; Michael A. LEVATIC [US]; Jimmy T. LIANG [US]; Jason C. RECH [US]; Brad M. SAVALL [US]; Akinola SOYODE-JOHNSON [NG]; Brice STENNE [CA]; Devin M. SWANSON [US]; Jessica L. WALL [US]
- (74) **Agente/apoderado:** DIEGO DUFRECHU RODRIGUEZ (192)
- (54) **Título:** DERIVADOS DE PIRAZOLO-[3,4-C]PIRIDINA COMO MODULADORES DEL RECEPTOR P2X7

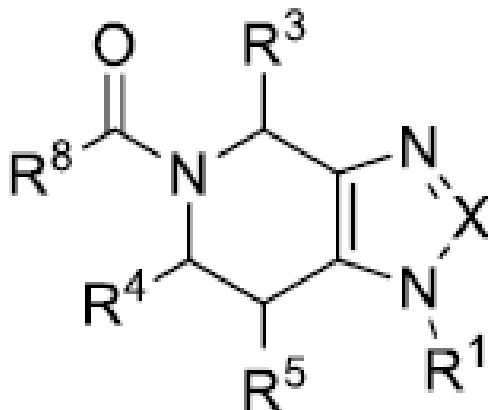

- (57) **Resumen:** La presente invención divulga compuestos derivados de PIRAZOLO-[3,4- C]PIRIDINA de Fórmula (IIa y IIb) Estos compuestos actúan biológicamente como moduladores del receptor P2X7

**(19) Dirección Nacional de la Propiedad Industrial – URUGUAY****(12) Invención****(11) UY a/ 039897**

- (51) **Clasificación Internacional:** G 01R 19/165, G 08B 21/18, 25/10  
(22) **Fecha de presentación:** 12/08/2022  
(30) **Datos de prioridad:**  
(71) **Solicitante:** Brida Carolina Conde Roa [CO] y Mario Joaquin Delgado Echenagusia [UY]  
(72) **Inventor:** Brida Carolina Conde Roa [CO]; Mario Joaquín Delgado Echenagusia [UY]  
(74) **Agente/apoderado:** Brida Carolina Conde Roa ()  
(54) **Título:** SISTEMA Y DISPOSITIVO DE CONTROL Y ALARMA REMOTO DE ALAMBRADOS ELÉCTRICOS USANDO MENSAJE CELULAR

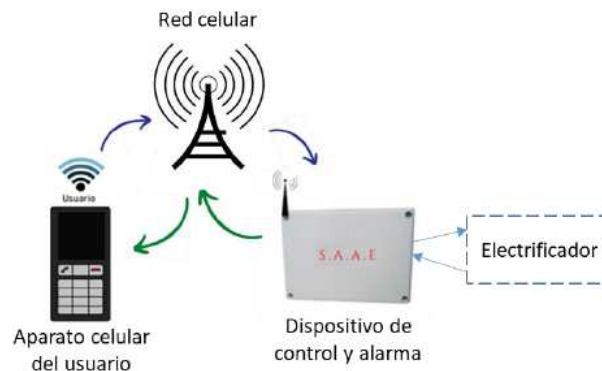

- (57) **Resumen:** Sistema de control y alarma remota del estado de electrificadores vía mensaje de texto. Compuesto por: la red celular, el celular del usuario, el electrificador instalado en la cerca y el dispositivo de control y alarma, cuya vinculación permite tomar la medida de tensión del electrificador conectado a un alambrado eléctrico y comparar dicha señal con una tensión especificada como "normal", para establecer una alarma y enviar aviso de la misma por medio de un mensaje de texto. Así mismo apaga/enciende remotamente el electrificador a voluntad del usuario.

## ***SOLICITUDES DE DISEÑOS INDUSTRIALES***

**(19) Dirección Nacional de la Propiedad Industrial – URUGUAY**

**(12) Diseño Industrial**

**(11) UY s/ 004936**

- (51) Clasificación Internacional:** G 06Q 20/1220-01
- (22) Fecha de presentación:** 20/01/2022
- (30) Datos de prioridad:** 100098 19/08/2021 AR
- (71) Solicitante:** TECH FUND S.R.L [UY]
- (72) Inventor:** Victoria Slaker [US]; Nicolas Lenotte [FR]
- (74) Agente/apoderado:** Gustavo Fischer Fleurquin (94)
- (54) Título:** DISPOSITIVO DE PAGO ELECTRONICO



**(57) Resumen:**

**(19) Dirección Nacional de la Propiedad Industrial – URUGUAY****(12) Diseño Industrial****(11) UY s/ 004937**

- (51) Clasificación Internacional:** G 06Q 20/1220-01
- (22) Fecha de presentación:** 20/01/2022
- (30) Datos de prioridad:** 100099 19/08/2021 AR
- (71) Solicitante:** TECH FUND S.R.L [UY]
- (72) Inventor:** Victoria Slaker [US]; Nicolas Lenotte [FR]
- (74) Agente/apoderado:** Gustavo Fischer Fleurquin (94)
- (54) Título:** DISPOSITIVO DE PAGO ELECTRONICO

**(57) Resumen:**

**(19) Dirección Nacional de la Propiedad Industrial – URUGUAY****(12) Diseño Industrial****(11) UY s/ 004939**

- (51) Clasificación Internacional:** G 06Q 20/1220-01
- (22) Fecha de presentación:** 20/01/2022
- (30) Datos de prioridad:** 100100 19/08/2021 AR
- (71) Solicitante:** TECH FUND S.R.L [UY]
- (72) Inventor:** Victoria Slaker [US]; Nicolas Lenotte [FR]
- (74) Agente/apoderado:** Gustavo Fischer Fleurquin (94)
- (54) Título:** DISPOSITIVO DE PAGO ELECTRONICO

**(57) Resumen:**

**(19) Dirección Nacional de la Propiedad Industrial – URUGUAY****(12) Diseño Industrial****(11) UY s/ 004940**

- (51) Clasificación Internacional: G 06Q 20/1220-01  
(22) Fecha de presentación: 20/01/2022  
(30) Datos de prioridad: 100101 19/08/2021 AR  
(71) Solicitante: TECH FUND S.R.L [UY]  
(72) Inventor: Victoria Slaker [US]; Nicolas Lenotte [FR]  
(74) Agente/apoderado: Gustavo Fischer Fleurquin (94)  
(54) Título: DISPOSITIVO DE PAGO ELECTRONICO

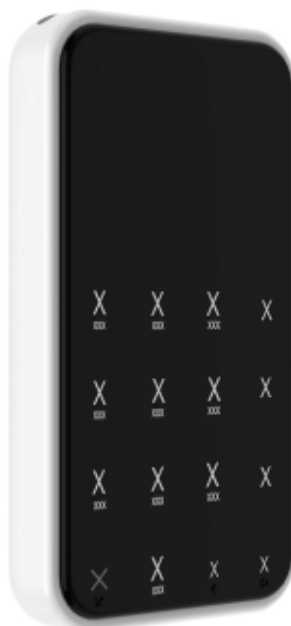
**(57) Resumen:**



**(19) Dirección Nacional de la Propiedad Industrial – URUGUAY****(12) Diseño Industrial****(11) UY s/ 004943**

- (51) **Clasificación Internacional:** B 62D 31/0012-08  
(22) **Fecha de presentación:** 29/03/2022  
(30) **Datos de prioridad:** 202130648844.8 29/09/2021 CN  
(71) **Solicitante:** CHERY AUTOMOBILE CO., LTD [CN]  
(72) **Inventor:** GAO, Xinhua [CN]  
(74) **Agente/apoderado:** FABIANA PENADES (216)  
(54) **Título:** COCHE



- (57) **Resumen:** El presente diseño pertenece al sector de la industria automotriz y se refiere a un nuevo diseño, original y ornamental de un coche.

**(19) Dirección Nacional de la Propiedad Industrial – URUGUAY****(12) Diseño Industrial****(11) UY s/ 004944**

- (51) **Clasificación Internacional:** A 47K 5/1209-01  
(22) **Fecha de presentación:** 06/04/2022  
(30) **Datos de prioridad:** 29/810,549 06/10/2021 US  
(71) **Solicitante:** SPARTAN CHEMICAL COMPANY, INC. [US]  
(72) **Inventor:** SCHALITZ, William J. [US]; NATARAJAN, Prasanna [US]; PARKER, Grey [US]; GENORD, Daniel [US]  
(74) **Agente/apoderado:** FABIANA PENADES (216)  
(54) **Título:** MODELO INDUSTRIAL DE DISPENSADOR DE JABÓN



- (57) **Resumen:** La presente invención se refiere a un Modelo Industrial de dispensador de jabón, totalmente diferente de los conocidos, caracterizándose por su forma especial y ornato que le proporcionan un aspecto peculiar y propio.

**(19) Dirección Nacional de la Propiedad Industrial – URUGUAY****(12) Diseño Industrial****(11) UY s/ 004949**

- (51) Clasificación Internacional:** B 65D 1/0209-01
- (22) Fecha de presentación:** 02/05/2022
- (30) Datos de prioridad:** 100699 04/11/2021 AR
- (71) Solicitante:** YPF S.A. [AR]
- (72) Inventor:** Andrés ERSKIS [AR]
- (74) Agente/apoderado:** GONZALO FERNÁNDEZ SECCO (34)
- (54) Título:** ENVASE

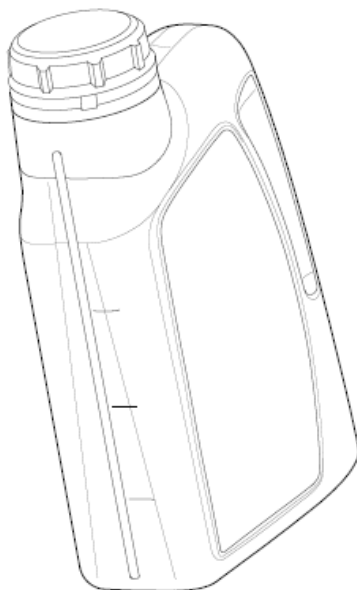
**(57) Resumen:**

**(19) Dirección Nacional de la Propiedad Industrial – URUGUAY****(12) Diseño Industrial****(11) UY s/ 004950**

- (51) Clasificación Internacional:** B 65D 1/0209-01
- (22) Fecha de presentación:** 02/05/2022
- (30) Datos de prioridad:** 100700 04/11/2021 AR
- (71) Solicitante:** YPF S.A. [AR]
- (72) Inventor:** Andrés ERSKIS [AR]
- (74) Agente/apoderado:** GONZALO FERNÁNDEZ SECCO (34)
- (54) Título:** ENVASE

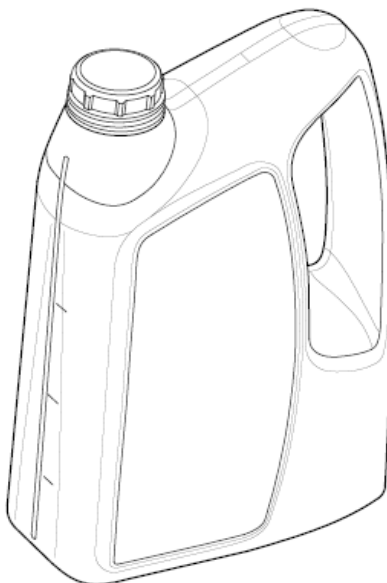
**(57) Resumen:**

**(19) Dirección Nacional de la Propiedad Industrial – URUGUAY****(12) Diseño Industrial****(11) UY s/ 004971**

- (51) **Clasificación Internacional:** G 11B 20/1014-01  
(22) **Fecha de presentación:** 10/08/2022  
(30) **Datos de prioridad:** JP 2022-003425 22/02/2022 JP  
(71) **Solicitante:** SONY INTERACTIVE ENTERTAINMENT INC. [JP]  
(72) **Inventor:** Yujin, MORISAWA [JP]; Yoshiyuki OTSUKA [JP]  
(74) **Agente/apoderado:** MATIAS CIKATO (201)  
(54) **Título:** PANTALLA MONTADA EN LA CABEZA

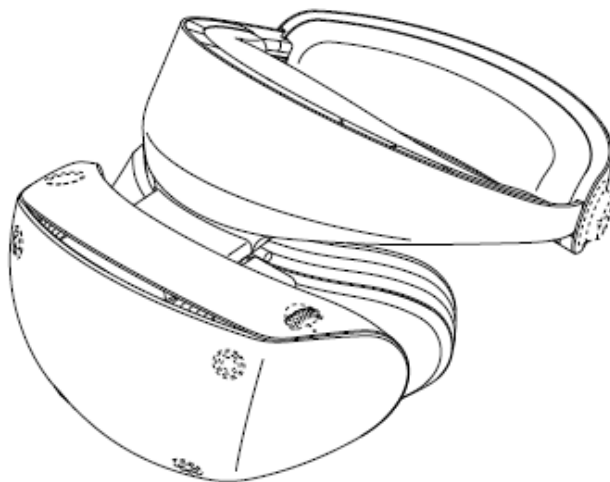

- (57) **Resumen:** El presente diseño industrial corresponde a una pantalla montada en la cabeza, diferente de las conocidas, cuya apariencia original y ornamental le confieren características de individualidad.

**(19) Dirección Nacional de la Propiedad Industrial – URUGUAY****(12) Diseño Industrial****(11) UY s/ 004972**

- (51) **Clasificación Internacional:** G 11B 20/1014-01  
(22) **Fecha de presentación:** 10/08/2022  
(30) **Datos de prioridad:** JP 2022-003426 22/02/2022 JP  
(71) **Solicitante:** SONY INTERACTIVE ENTERTAINMENT INC. [JP]  
(72) **Inventor:** Yujin, MORISAWA [JP]  
(74) **Agente/apoderado:** MATIAS CIKATO (201)  
(54) **Título:** PANTALLA MONTADA EN LA CABEZA

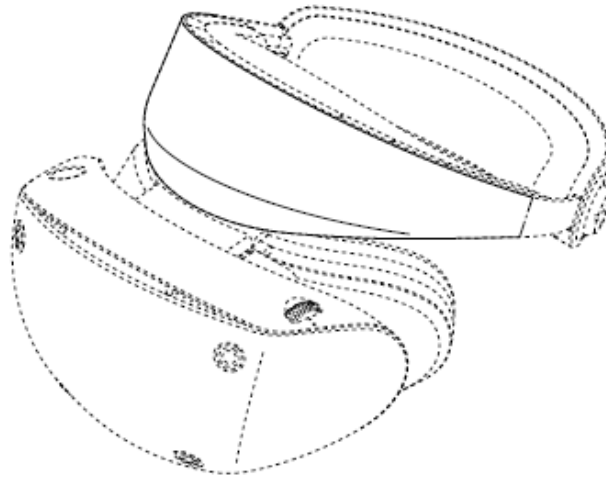

- (57) **Resumen:** El presente diseño industrial corresponde a una pantalla montada en la cabeza, diferente de las conocidas, cuya apariencia original y ornamental le confieren características de individualidad.

**(19) Dirección Nacional de la Propiedad Industrial – URUGUAY****(12) Diseño Industrial****(11) UY s/ 004973**

- (51) **Clasificación Internacional:** G 11B 20/1014-01  
(22) **Fecha de presentación:** 10/08/2022  
(30) **Datos de prioridad:** JP 2022-003427 22/02/2022 JP  
(71) **Solicitante:** SONY INTERACTIVE ENTERTAINMENT INC. [JP]  
(72) **Inventor:** Yujin, MORISAWA [JP]  
(74) **Agente/apoderado:** MATIAS CIKATO (201)  
(54) **Título:** PANTALLA MONTADA EN LA CABEZA

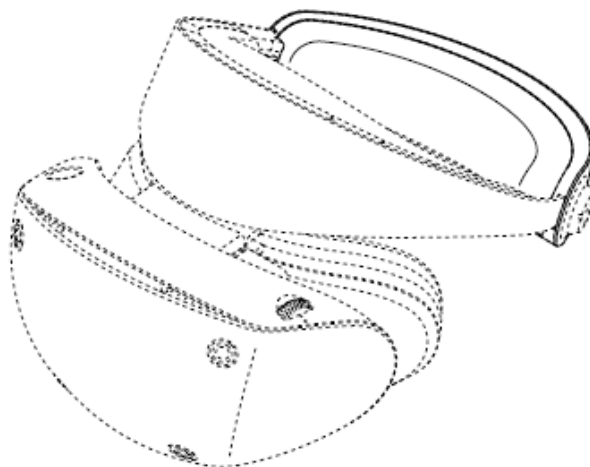

- (57) **Resumen:** El presente diseño industrial corresponde a una pantalla montada en la cabeza, diferente de las conocidas, cuya apariencia original y ornamental le confieren características de individualidad.

**(19) Dirección Nacional de la Propiedad Industrial – URUGUAY****(12) Diseño Industrial****(11) UY s/ 004974**

- (51) **Clasificación Internacional:** G 11B 20/1014-01
- (22) **Fecha de presentación:** 10/08/2022
- (30) **Datos de prioridad:** JP 2022-003428 22/02/2022 JP
- (71) **Solicitante:** SONY INTERACTIVE ENTERTAINMENT INC. [JP]
- (72) **Inventor:** Yujin, MORISAWA [JP]
- (74) **Agente/apoderado:** MATIAS CIKATO (201)
- (54) **Título:** PANTALLA MONTADA EN LA CABEZA

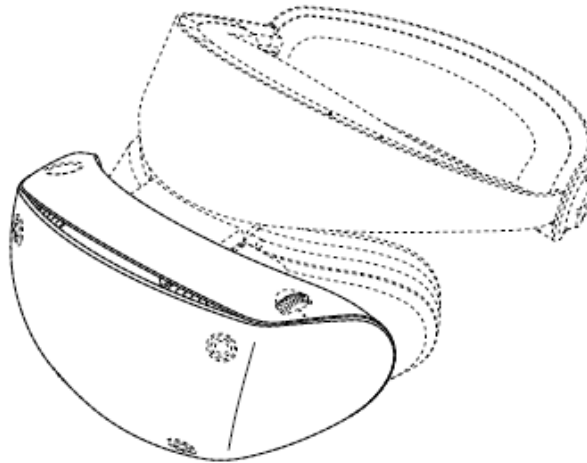

- (57) **Resumen:** El presente diseño industrial corresponde a una pantalla montada en la cabeza, diferente de las conocidas, cuya apariencia original y ornamental le confieren características de individualidad.



**(19) Dirección Nacional de la Propiedad Industrial – URUGUAY****(12) Diseño Industrial****(11) UY s/ 004975**

- (51) **Clasificación Internacional:** G 11B 20/1014-01  
(22) **Fecha de presentación:** 10/08/2022  
(30) **Datos de prioridad:** JP 2022-003429 22/02/2022 JP  
(71) **Solicitante:** SONY INTERACTIVE ENTERTAINMENT INC. [JP]  
(72) **Inventor:** Yujin, MORISAWA [JP]; Yoshiyuki OTSUKA [JP]  
(74) **Agente/apoderado:** MATIAS CIKATO (201)  
(54) **Título:** PANTALLA MONTADA EN LA CABEZA

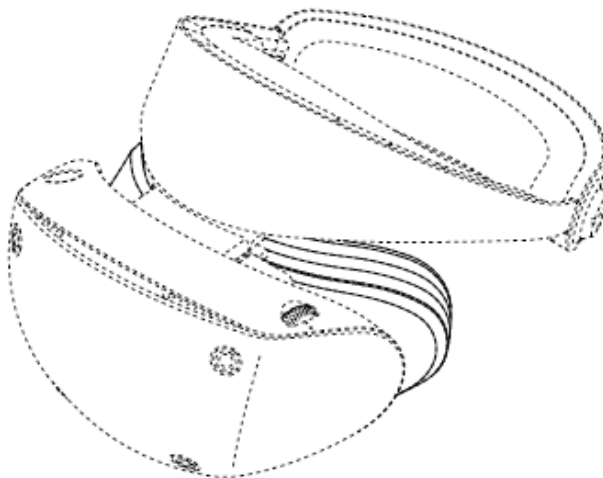

- (57) **Resumen:** El presente diseño industrial corresponde a una pantalla montada en la cabeza, diferente de las conocidas, cuya apariencia original y ornamental le confieren características de individualidad.

**(19) Dirección Nacional de la Propiedad Industrial – URUGUAY****(12) Diseño Industrial****(11) UY s/ 004976**

- (51) Clasificación Internacional:** G 11B 20/1014-01
- (22) Fecha de presentación:** 10/08/2022
- (30) Datos de prioridad:** JP 2022-003430 22/02/2022 JP
- (71) Solicitante:** SONY INTERACTIVE ENTERTAINMENT INC. [JP]
- (72) Inventor:** Yujin, MORISAWA [JP]; Yoshiyuki OTSUKA [JP]
- (74) Agente/apoderado:** MATIAS CIKATO (201)
- (54) Título:** PROTECTOR CONTRA LA LUZ

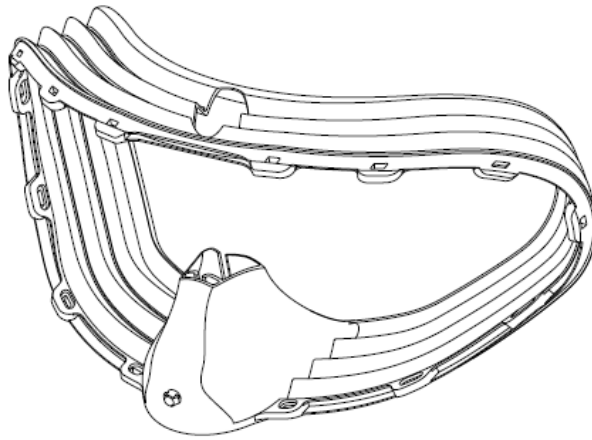

- (57) Resumen:** El presente diseño industrial corresponde a un protector contra la luz, diferente de los conocidos, cuya apariencia original y ornamental le confieren características de individualidad.

## ***SOLICITUDES DE MODELOS DE UTILIDAD***

**(19) Dirección Nacional de la Propiedad Industrial – URUGUAY**

**(12) Modelo de Utilidad**

**(11) UY u/ 004800**

- (51) **Clasificación Internacional:** A 01G 13/00  
(22) **Fecha de presentación:** 28/10/2020  
(30) **Datos de prioridad:**  
(71) **Solicitante:** Federico Villagrán [UY]  
(72) **Inventor:** Federico Villagrán [UY]  
(74) **Agente/apoderado:** Federico Villagrán ()  
(54) **Título:** RECICLAJE DE PAÑAL DESCARTABLE USADO, PARA USO AGRÍCOLA

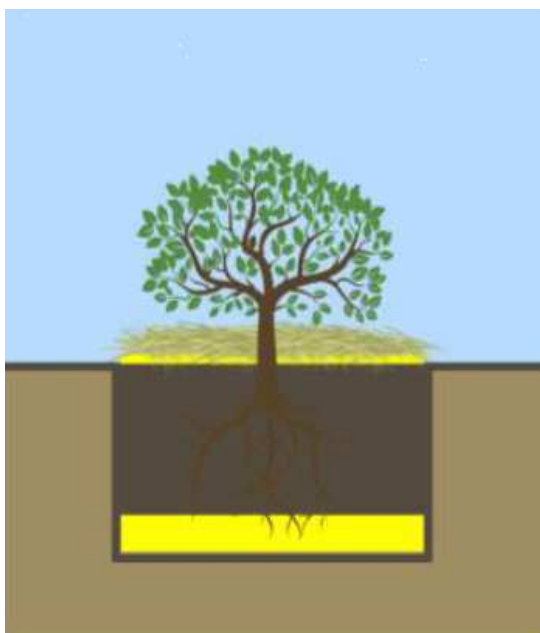

- (57) **Resumen:** El reciclaje de pañales descartables para uso agrícola tiene el objetivo de conservar la humedad recibida sobre la tierra, y también fertilizar. Los componentes de los pañales descartables son celulosa y gel, ambos tienen la particularidad de absorber y conservar el agua por un período de tiempo. Se propone esta patente para que sea utilizada públicamente con fines humanitarios y sin fines de lucro. Se puede considerar un pago justo a las madres que realicen el reciclaje.

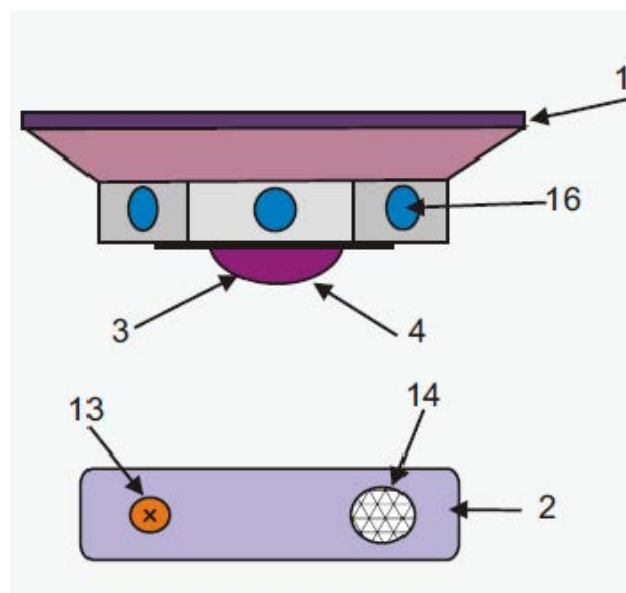
**(19) Dirección Nacional de la Propiedad Industrial – URUGUAY****(12) Modelo de Utilidad****(11) UY u/ 004817****(51) Clasificación Internacional:** G 08B 21/14**(22) Fecha de presentación:** 15/09/2021**(30) Datos de prioridad:****(71) Solicitante:** Olicio Nuñez [UY]**(72) Inventor:** Olicio Nuñez [UY]**(74) Agente/apoderado:** MARTINEZ GARCIA, MARIA CECILIA (171)**(54) Título:** ALARMA DETECTORA DE GAS Y HUMO**(57) Resumen:** Alarma de detección de gases y humo con corte de suministro, con dispositivo inalámbrico remoto y con video cámara de 360 grados.



## **ÍNDICE POR TITULARES DE MARCAS**

<b>Titular</b>	<b>N° Exp</b>	<b>Marca</b>
AB Mauri (UK) Limited	541677	PINNACLE
ABEMOL S.A.	541769	THE COFFEE SHOP PREMIUM ROASTERS (mixta)
ABEMOL S.A.	541770	THE COFFEE SHOP PREMIUM ROASTERS (mixta)
ABRA GROUP LIMITED	541343	ABRA
ACIL TEXTIL EIRELI	541044	GO UNITED (mixta)
ACONCAGUA FOODS S.A.	540994	ACONCAGUA
ACONCAGUA FOODS S.A.	540993	ACONCAGUA SABOR NUESTRO (mixta)
AD AREA DESIGN SAS	540509	AREA DESIGN (mixta)
ADM DO BRASIL LTDA	540244	VITALIV (mixta)
ADM International Sàrl	540288	NUTRIFLEX
ADM International Sàrl	540287	EDGEFLEX
ADM International Sàrl	540561	MAXFLEX
ADM International Sàrl	540562	NUTRISTEM
ADM International Sàrl	540560	ACCELFLEX
Administración Nacional de Telecomunicaciones (Antel)	541405	ANTELTV (mixta)
Administración Nacional de Telecomunicaciones (Antel)	541407	EVENTOS (mixta)
Administración Nacional de Telecomunicaciones (Antel)	541278	ANTELEVENTOS
Administración Nacional de Telecomunicaciones (Antel)	541274	ANTEL TV (mixta)
Administración Nacional de Telecomunicaciones (Antel)	541408	PLANAZO
Administración Nacional de Telecomunicaciones (Antel)	541406	EVENTOS (mixta)
Agustin Groba	541522	ALLIGATORHIDE (mixta)
Agustín Herrero	541645	OLMEDA ORIGENES
Agustin Ortiz	540939	CONSTRUCTORA MONTEVIDEO
AJS S.R.L.	541390	LA ESQUINA DE LA PILA (mixta)
Alberico Passadore	541695	FAMILIA PASSADORE
Alberto ANGIOLILLO AYUSTO	541163	PASCUALITO
Alberto Rodolfo Klüver Pacheco	541754	POLO LOGÍSTICO DURAZNO
ALCESTER S.A.	541415	CLEVER PRODUCCIONES (mixta)
Alejandro Pastori	541319	ARREGLOS YA
ALEL 19 SRL	540181	ALL ROAD (mixta)
ALGORAND, INC.	540806	ALGORAND
ALGORAND, INC.	540807	A (mixta)
AMARAL SCHIAFFINO CARLOS CESAR , RAMBO HENRIETTE Y OTROS	540980	AMARAL SOLUCIONES QUE TRANSFORMAN (mixta)
AMARAL SCHIAFFINO CARLOS CESAR , RAMBO HENRIETTE Y OTROS	540983	AMARAL SOLUCIONES QUE TRANSFORMAN (mixta)
ANDRÉ LUIS BORBA DA SILVA	541717	OCULOPLASTICS ACADEMY (mixta)
ANGELINI HOLDING S.P.A.	540918	(figurativa)
ANHUI SUNSHINE STATIONERY CO.,LTD	541348	FOSKA
ANITDOR S.A.	540695	CENTEL ASISTENCIA (mixta)
ANTIA MOLL Y CIA. S.A.	540845	CURAMAX

<b>Titular</b>	<b>N° Exp</b>	<b>Marca</b>
ANTONIO BASSO & FILHOS LTDA.	541264	WINE COOLER (mixta)
ANTONIO BASSO & FILHOS LTDA.	541266	VINHO CANÇÃO CANÇÃO TRADIÇÃO DESDE 1970 (mixta)
APPLE INC.	541917	(figurativa)
ARBULO PIROTTTO, VIRGINIA	540899	VA ORDENADO
Arla Foods Ingredients Group P/S	541692	LACPRODAN HIGH QUALITY PROTEIN (mixta)
ASENCIO RIQUELME, AXEL EDUARDO	541634	AX PAPAX AX (mixta)
ASENCIO RIQUELME, AXEL EDUARDO	541635	AX CONITOX AX (mixta)
ASENCIO RIQUELME, AXEL EDUARDO	541633	AX AX (mixta)
ASOCIACION CIVIL DE CRIADORES DE CABALLOS CRIOLLOS DEL URUGUAY	541170	CRIOLLOS DE AMERICA
ASOS HOLDINGS LIMITED	541030	MISS SELFRIDGE
JHONATAN SNAIDER y AVI SNAIDER	540857	MAGAL
JHONATAN SNAIDER y AVI SNAIDER	540853	X NIMAX (mixta)
JHONATAN SNAIDER y AVI SNAIDER	540851	TAXIM (mixta)
AYMI S.R.L.	541207	M DE MUJER (mixta)
BALIARDA S.A.	540793	VODIX
BALIARDA S.A.	540794	XEVORT
BANCO DE LA PROVINCIA DE BUENOS AIRES	541496	PROVINCIA CASA FINANCIERA (mixta)
BASF S.A.	541217	SUVINIL (mixta)
BaYi Rubber Co.,Ltd.	541054	WONDERLAND (mixta)
Beiersdorf AG	541794	NIVEA MEN FRESH ICE
Beiersdorf AG	541793	PARCHE LEÓN (mixta)
BELTRAME & CIA.	541234	B (mixta)
BELTRAME & CIA.	541235	R BELTRAME & CÍA. (mixta)
BELTRAME & CIA.	540790	BELTRAME & CIA. GENTE DE BUENA SEMILLA (mixta)
BIMEDA Animal Health Limited	541356	MOXISTRIKE
Biohaven Pharmaceutical Ireland DAC	541010	NURTEC
Biohaven Pharmaceutical Ireland DAC	541009	(figurativa)
BIOHEALTH GROUP	522234	BIOHEALTH GROUP BHG (mixta)
Blumarel S.A.	541336	SUBZERO
Blumarel S.A.	541334	ELDEN (mixta)
Blumarel S.A.	541337	WOLF
BLUMENAU ILUMINAÇÃO LTDA.	541105	BLUMENAU ILUMINAÇÃO (mixta)
BOCACHA FILMS S.A.S.	541280	BOCACHA FILMS (mixta)
BOUDAKIAN BADANIAN, KRIKOR MIKAEL	540892	URBANO FEST (mixta)
Bruno Grisi	541747	SENDEROS - RITUALES CONTEMPORÁNEOS
BURGOS GARCÍA, MARY BEATRIZ	541293	CR COLOR RED (mixta)
CABAL COOPERATIVA DE PROVISION DE SERVICIOS LIMITADA	541742	TIENDA CABAL
CABIFY ESPAÑA S.L.	540890	CABIFY (mixta)
CABIFY ESPAÑA S.L.	540889	CABIFY
CAN Technologies, Inc.	541786	TRUMUNE
CARBAJAL STOPINGI CESAR AUGUSTO Y ALONSO JAUREGUY SANTIAGO SOCIEDAD DE HECHO	540936	PROFEED (mixta)
CARBAJAL STOPINGI CESAR AUGUSTO Y	540870	PROFEED

<b>Titular</b>	<b>N° Exp</b>	<b>Marca</b>
ALONSO JAUREGUY SANTIAGO SOCIEDAD DE HECHO		
Carina Antonella Minetti Pereira	541805	MINETTI (mixta)
CARLOS ADRIÁN LUCERO CORREA	541113	AAAH TOLOLO
Carlos Fabian Barrales Rodríguez	541391	CARGADORESUY (mixta)
CARMANIA S.R.L.	540652	WFENG (mixta)
CASA PIRQUE S.A.	540781	RIBERA DEL CUARZO
Cash S.A.	541055	TIENDA CASH (mixta)
CEAR S.A. - COMPAÑÍA EMBOTELLADORA DE AGUAS Y REFRESCOS	541122	NET (mixta)
CEAR S.A. - COMPAÑÍA EMBOTELLADORA DE AGUAS Y REFRESCOS	541124	AGUA MINERAL NATURAL ESENCIAL NACE AL PIE DEL PAN DE AZÚCAR (mixta)
Jorge Rodríguez Lara y Celia Giménez	540637	TERSUS LIMPIEZAS INTEGRALES (mixta)
Center lab limitada.	541803	CENTER LAB (mixta)
Century 21 Real Estate LLC	541788	CENTURY 21 (mixta)
Chioino Garin Arquitectos SRL	540927	AXET (mixta)
Chioino Garin Arquitectos SRL	540929	X (mixta)
C.O.M. DE LA A.O.U.	540972	RED DENTIS COOPERATIVA ODONTOLÓGICA DE MONTEVIDEO (mixta)
COMERCIAL DEXIM SpA	540804	BAMERS
CONFEDERACIÓN SUDAMERICANA DE FÚTBOL	540465	INTERCONTINENTAL (mixta)
COOPERATIVA DE TRABAJO ECOSINERGIA	540651	BIOFRAMING
Cooperativa de Trabajo Helix Uruguay	540979	HELIX
COOPERATIVA REGIONAL DE CAFEICULTORES EM GUAXUPÉ LTDA. - COOXUPÉ	541795	COOXUPÉ CAFÉ GOURMET PRIMA QUALITÀ (mixta)
CRACKS UNIVERSITARIOS SAS	541090	GO CRACKS (mixta)
DaGrosa Capital Partners LLC	541103	AXXES CAPITAL
daniel terminelli	541000	VINCOLA
daniel terminelli	541355	ROCKOLA
Daniela Guerra	540795	MIMUSA TU BELLEZA NOS INSPIRA (mixta)
Danilum S.A.	541465	CARLOTTA BARRIO DE LAGOS (mixta)
DARDANELLI PESCE, ALBA GLORIA	540919	VINOS 3 PALMAS (mixta)
DASS NORDESTE CALÇADOS E ARTIGOS ESPORTIVOS S.A.	540856	TRYON
DE ARMAS LUCIANO, SOFIA	540798	COPA UY
DE ARMAS LUCIANO, SOFIA	540796	ECODELUY
DECATHLON SE	540912	D (mixta)
DECATHLON SE	541091	(figurativa)
DECATHLON SE	541093	(figurativa)
DENTAL PRO S.A.S.	541012	DENTALPRO (mixta)
DEYUNTAS INDUMENTARIA S.R.L.	541454	DY DEYUNTAS (mixta)
DEYUNTAS INDUMENTARIA S.R.L.	541453	DA D´AVILA (mixta)
Diego Álvarez	541246	PCH PUNTA CHACRA (mixta)
DIEGO BATTISTE	541563	A AUTÓCTONOS (mixta)
Diego Carlotta	540830	SOUNDCITY
DIGITAL IMPORT SAS	541413	CHICKEN UP (mixta)
DISTRITO S A	540838	XY RETAIL (mixta)



Titular	N° Exp	Marca
DOMINGUEZ BORGES CESAR ANDRÉS Y VIOTTI DOMINGUEZ NATALIA ERIKA SOCIEDAD DE HECHO	541013	FERREXPRESS
DOMINGUEZ BORGES CESAR ANDRÉS Y VIOTTI DOMINGUEZ NATALIA ERIKA SOCIEDAD DE HECHO	541014	FERREXPRESS (mixta)
Droguería Hierbas del Oasis S.R.L.	540931	HIERBAS DEL OASIS (mixta)
Droguería Hierbas del Oasis S.R.L.	540933	HIERBAS DEL OASIS (mixta)
Droguería Hierbas del Oasis S.R.L.	540930	HIERBAS DEL OASIS (mixta)
DSM IP Assets B.V.	541211	OCHRAZYME
DUPONT ELECTRONICS, INC.	541088	MICROMAX
Durman Esquivel S.A.	541908	DUAL FORCE (mixta)
E. REMY MARTIN & C°	540832	LOUIS XIII
EGT Digital Ltd.	540308	EGT DIGITAL (mixta)
EL IMPERIO DE LA PIZZA	540397	EL IMPERIO DE LA PIZZA
EL TRIGAL S.A.	540704	ANILLOS
Eli Lilly and Company	540915	KISUNLA
Eliana Soledad Armand Ugon Suarez	540389	IKMAX (mixta)
Elizabeth Hasteings	521934	DIBELLA (mixta)
EMILIO MIRO SALVAT S.A	541920	VERMUTS MIRÓ (mixta)
EMPRESA PROGRESO S. A.	540700	JARDÍN MEMORIAL LOS OLIVOS CONMEMORAMOS LA VIDA (mixta)
ENDIFAR S.A.	541508	SURPRISE SHIRTS (mixta)
ENERGY GROUP S.R.L.	541562	LIMITE
ENERGY GROUP S.R.L.	541560	LIDER SPEED UNLIMITED (mixta)
EQRx International, Inc.	540222	AUMSEQA
EQRx International, Inc.	540223	EQJUBI
Essity Hygiene and Health Aktiebolag	541597	MAX CUR-V (mixta)
Esteban Hugo Pivetta	541437	APERTIO (mixta)
Esteban Hugo Pivetta	541438	APERTIO (mixta)
ETIA URUGUAY S.A.	541100	ETIA (mixta)
EURO GAMES TECHNOLOGY LTD.	540305	VLT GLOBAL SOLUTION (mixta)
EURO GAMES TECHNOLOGY LTD.	540303	EGT (mixta)
EURO GAMES TECHNOLOGY LTD.	540301	CRYSTAL WIN
EURO GAMES TECHNOLOGY LTD.	540299	BURNING HOT
EURO GAMES TECHNOLOGY LTD.	540306	SPIDER CASINO MANAGEMENT SYSTEM (mixta)
EURO GAMES TECHNOLOGY LTD.	540302	SHINING CROWN
EURO GAMES TECHNOLOGY LTD.	540300	FLAMING HOT
EUROPEAN COSMETICS LTDA	540525	ECOBIER
EVEREST REAL ESTATE SAS	541216	EVEREST REAL ESTATE (mixta)
Claudio Guattini y Fabricio Bagnuoli	540779	CANDOMBE LA PLAZA, SOMOS BARRIO BELGRANO (mixta)
Facundo Borges	541209	CAUTIVA (mixta)
FALABELLA S.A.	540791	FL FLEXIT (mixta)
FALABELLA S.A.	541500	FPAY LATER
FALABELLA S.A.	540876	FL FLEXIT (mixta)
Farinur S.A.	538908	FARINUR (mixta)
Faron Pharmaceuticals Oy	541519	BEXIGNUS
Faron Pharmaceuticals Oy	541521	BEXCLEVY
Felipe Albanell	541703	GOURMEAT BOUTIQUE DE CARNES (mixta)
felipe benedetti	541531	HEAFF

Titular	N° Exp	Marca
Felizo S.A.	522821	PRESAGE
FERNÁNDEZ GIAMBRUNO JOAQUIN Y FERNÁNDEZ GIAMBRUNO MATEO SOCIEDAD DE HECHO	541498	PRESTARIO (mixta)
Leandro J. Vainberg y Fernando D. Vainberg	541877	VOLF (mixta)
FERNANDO KONSTANTINOVICH GARCIA	541114	STATUS (mixta)
Fernando Olivera Costa	540531	FORAJIDA (mixta)
FERNANDO RUBEN POZO	541527	CIRCULAR ORIENTAL
FERRERO S.P.A.	540373	KINDER HUEVO (mixta)
FERRERO S.P.A.	540377	KINDER OVO (mixta)
Fideicomiso de Administración del Museo del Carnaval	541330	SALA DEL MUSEO DEL CARNAVAL
Florencia Belén Siri	541176	SOMOS MODO (mixta)
Florencia Cioli	540722	RÍCCOLI RICO&SINGLUTEN (mixta)
Foshan Alpicool Electric Appliance Co., Ltd.	541553	ALPICOOL (mixta)
Fulvier S.A.	541541	HERCULES
GAC AION NEW ENERGY AUTOMOBILE CO., LTD.	541096	AION
GAC AION NEW ENERGY AUTOMOBILE CO., LTD.	541097	AION (mixta)
GANI S.A.	540703	GANI (mixta)
GASTON SIMI BARCELÓ	540658	PIRAÑA COAST (mixta)
GASTON SIMI BARCELÓ	540656	PIRAÑA COAST (mixta)
German Daniel Fernandez Laborda	541910	LA NOCHE DE LOS RECUERDOS
Gilead Sciences Ireland UC	541063	MACPHIO
Global Blood Therapeutics, Inc.	541595	OPROVDA
Global Blood Therapeutics, Inc.	541594	ECVOCY
Global Blood Therapeutics, Inc.	541592	OVOKLA
Global Blood Therapeutics, Inc.	541589	OVEZZO
Global Blood Therapeutics, Inc.	541587	VOCINBEQ
GOLDSTEIN ZONSEJNAS, SERGIO ADRIÁN	540938	MEDISHOP (mixta)
Gong cha Global Ltd	541612	GONG CHA (mixta)
Gong cha Global Ltd	541613	GONG CHA (mixta)
Gonzalo Alejandro Delgado Moreno	540982	COTIXE (mixta)
GOOD BRANDS LATAM S.A.	541075	SUNCO. POP (mixta)
GOOD BRANDS LATAM S.A.	541076	SUNCO. (mixta)
GPV S.A.	540698	OH! MYBED TU MEJOR SUEÑO (mixta)
GPV S.A.	540701	SUAVEGOM (mixta)
GRABOSKI, SEBASTIAN GUILLERMO	540961	EL QUÍMICO SPA DE ROPA (mixta)
Gramón Bagó de Uruguay S.A.	540841	LAXBENE
GRANDES PROYECTOS SAS	540363	GRAVITY
GRANDES PROYECTOS SAS	540362	MUNDO BAMBINO
GRUPO OPCION SAS	540283	GRUPOOPCION (mixta)
GRUPO PILAR S.A.	541349	ZIMPI (mixta)
GURIDAY S.A.	541649	TRENTO (mixta)
Hugo Cesar Benedetti San Pedro y Gustavo Gabriel Avakian	540679	GARBATELLA
Gustavo Rodríguez Vidal	541879	TODOCABALLO
HANGZHOU ALLTEST BIOTECH CO, LTD.	541463	BERIGHT (mixta)
HANGZHOU ALLTEST BIOTECH CO, LTD.	541468	A ALLTEST (mixta)
HANGZHOU ALLTEST BIOTECH CO, LTD.	541467	JUSCHEK (mixta)

<b>Titular</b>	<b>N° Exp</b>	<b>Marca</b>
HAZUY SAS	541722	HAZIAK
HENDERSON & CIA. S.A.	541499	BARNY'S BEST BURGER (mixta)
HENDERSON & CIA. S.A.	540894	TODOS SUBIDOS AL CARRO DE TIENDA INGLESA (mixta)
HIBRA COMERCIO DE ALIMENTOS LTDA	540975	CELIVITA GLUTEN FREE (mixta)
HIF Global LLC	541061	(figurativa)
HIF Global LLC	541060	HIF (mixta)
HIF Global LLC	541058	HIF HIGHLY INNOVATIVE FUELS
HISPA-GUAY S.A.S	541708	S&B PRODUCTO ESPAÑOL (mixta)
HONDA MOTOR CO., LTD.	541140	XRE300 SAHARA
HRU S.A.	541493	MARONAS (mixta)
HUIZHOU ESLINDA TECHNOLOGY CO.,LTD.	541151	TTKIN (mixta)
Hyundai Motor Company	540780	H (mixta)
Hyundai Motor Company	540776	H (mixta)
Hyundai Motor Company	540777	H (mixta)
Hyundai Motor Company	540785	H HYUNDAI (mixta)
Hyundai Motor Company	540784	H HYUNDAI (mixta)
Hyundai Motor Company	540778	H (mixta)
Hyundai Motor Company	540782	H HYUNDAI (mixta)
Hyundai Motor Company	540783	H HYUNDAI (mixta)
IBSA Institut Biochimique S.A.	540775	IBESIA
ILOVEDAYMAN S.A.S.	541817	IDAYMAN (mixta)
ILOVEDAYMAN S.A.S.	541824	IDAYMAN (mixta)
ILOVEDAYMAN S.A.S.	541829	IDAYMAN (mixta)
ILOVEDAYMAN S.A.S.	541815	IDAYMAN (mixta)
ILOVEDAYMAN S.A.S.	541827	IDAYMAN (mixta)
Immersive Health Solutions LLC	541025	REALITY PROCESSOR
Immersive Health Solutions LLC	541026	REALITY ONE
Immersive Health Solutions LLC	541175	REALITY ONE
Immersive Health Solutions LLC	541261	REALITY PRO
INTENDENCIA DE MONTEVIDEO	541184	LADO B (mixta)
INTENDENCIA DE MONTEVIDEO	541183	LADO B (mixta)
INTENDENCIA DE MONTEVIDEO	541182	CIUDAD VIVA (mixta)
INTENDENCIA DE MONTEVIDEO	541181	CIUDAD VIVA (mixta)
INTENDENCIA DE MONTEVIDEO	541178	MIRA MONTEVIDEO (mixta)
INTENDENCIA DE MONTEVIDEO	541177	MIRA MONTEVIDEO (mixta)
INTERVET INTERNATIONAL B.V.	541464	DEFENTRA
IRMARI LIMITADA	541483	FRAGRANCE KIWI
IXALAB S.A.S.	541518	IXALAB (mixta)
Izder Advisors S.A.	541001	TALENTPORT BY IZDER (mixta)
Javier Eduardo Amuchastegui	541540	TRÄUMER BIER (mixta)
Jemella Group Limited	540801	GHD
Jemella Group Limited	540803	GHD (mixta)
John Peter Sosa Chocho	541693	FARMAONLINEUY (mixta)
John Rich & Sons Investment Holding Company	537730	(figurativa)
JOIE INTERNATIONAL CO. LTD.	541098	JOIE (mixta)
JORGE EDUARDO SERRON BAUZIL	540559	OCÉANO SANITARIA (mixta)
Jorge Rodríguez Lara	540640	GSS FACILITY SERVICES (mixta)
Jorge Rodríguez Lara	540639	ERGON MENTENIMIENTO INTEGRAL (mixta)

<b>Titular</b>	<b>N° Exp</b>	<b>Marca</b>
Nicolas Pablo Sardi Piano; Nicolás Salvador Grosso Pérez; Raúl Ignacio Santos Rehermann; Javier José Misa Rodríguez y Jose Martín García Hutnik	540792	SOUND PRODUCCIONES (mixta)
Juan Carlos Jaime Jackson	541031	MAMMANTUS (mixta)
Juan Rodriguez	541353	FOCUS
María Belén Britos Rivera y Juan Sebastián Bonnevaux Irazoqui	541874	UNGA (mixta)
Daniel Gandini (22,50% de propiedad); Claudia Mariana Cristaldo (22,50% de propiedad) y Julio Roque Razzuk (55% de propiedad)	541451	LUTZ FERRANDO
Juniper Networks, Inc.	540808	MIST AI
KANDO INNOVATION LIMITED	540271	GUARDIAN (mixta)
KANIA INDÚSTRIA E COMÉRCIO DE ACUMULADORES LTDA - EPP	541431	DUTRA
KANIA INDÚSTRIA E COMÉRCIO DE ACUMULADORES LTDA - EPP	540923	FORT LIGHT (mixta)
KAWASAKI MOTORS, LTD.	541067	LET THE GOOD TIMES ROLL
Keli Network Inc.	539833	OH MY GOAL
KENDY BRINQUEDOS LTDA.	541526	KENDY (mixta)
Kim, Doo Sung	541250	PIEDRAFINA
Kimberly-Clark Worldwide, Inc.	541619	KLEENEX ALLERGY COMFORT
Kimberly-Clark Worldwide, Inc.	541650	KLEENEX WATER FRESH ALLERGY COMFORT
Kimberly-Clark Worldwide, Inc.	541485	NEVE TOQUE DA SEDA (mixta)
King of Queens, Inc.	540713	KING OF QUEENS
KIRICOCHO S.R.L.	541604	KIRICOCHO FÚTBOL COMPANY (mixta)
KREATORY S.A.	539454	SHOPPING AUTOS (mixta)
KT & G Corporation	541448	OTRA
KT & G Corporation	541449	RITMO
KT & G Corporation	541450	VOLAR
KT & G Corporation	541441	CUEVA
KT & G Corporation	541444	LUCERO
KT & G Corporation	541447	NOVA
KT & G Corporation	541439	ACCION
KT & G Corporation	541442	DIVE
KT & G Corporation	541446	MILONGA
KT & G Corporation	541440	ARDOR
KT & G Corporation	541443	FUERZA
KT & G Corporation	541445	MAXIMO
LA DIETETICA SAS	540909	MERCADO VERDE R (mixta)
LA POSTE	541596	(figurativa)
LABORATORIO CUENCA S.A.	541740	ISSUE CRAZY COLORS (mixta)
LABORATORIO CUENCA S.A.	541739	VN BY VILLENEUVE
LABORATORIO ELEA PHOENIX S.A	540991	EMERPIL
LABORATORIO ELEA PHOENIX S.A	540990	INFILTREX
LABORATORIO ELEA PHOENIX S.A.	541681	INFILTREX
LABORATORIO ELEA PHOENIX S.A.	540992	CVP FLEBO
LABORATORIO ELEA PHOENIX S.A.	540988	EVAGINA
LABORATORIO ELEA PHOENIX S.A.	541680	INFILTREX
LABORATORIO ELEA PHOENIX S.A.	540986	EVACOPA
LABORATORIO ELEA PHOENIX S.A.	540989	EVAGINA

<b>Titular</b>	<b>N° Exp</b>	<b>Marca</b>
LABORATORIO ELEA PHOENIX S.A.	540995	GASTROTOP (mixta)
LABORATORIO ELEA PHOENIX S.A.	540987	EVAGINA
LABORATORIOS CELSIUS S.A.	540969	NOVEDOL
LABORATORIOS CELSIUS S.A.	541457	BUCOSEPTINE CELSIUS
LABORATORIOS CELSIUS S.A.	541456	TRICOSAMINA
LABORATORIOS PELLIER S.R.L.	540900	PROLACID
LADIMIL S.A.	540839	ALASKA
LAKYFOR S.A.	540813	ADVICE (mixta)
LATAM Group SpA	540086	BBQOOL (mixta)
LEANDRO JAVIER CRISTOBAL	541365	PARADA SANGUCHERA (mixta)
LEASINGCAR SOCIEDAD ANÓNIMA	540521	LEASINGCAR (mixta)
LEGORMAR S.A.	541079	MODENAS ALIMENTOS PARA UN FUTURO SUSTENTABLE (mixta)
LEMARYON S.A.	541394	LO NORMAL EN EL DIA, LO URGENTE YA! DISTRICOMP (mixta)
LEMARYON S.A.	541393	ENVIO YA DISTRICOMP (mixta)
LEONELA RAGGIO	541647	CASA CRIOLLA TODO EN UN SOLO LUGAR (mixta)
L.H IMPORTACIONES S.A.S.	541484	KINGEVER
Liangpeng TENG	540726	MAAMGIC
LIFTEC	540676	LIFTEC (mixta)
LIFTEC S.A.	540843	ORTIZ FISCHER (mixta)
LIFTEC S.A.	540751	CHECKLIFT (mixta)
LINCK PERNAS, CARLOS EMILIANO	540937	FRÍA LA PORCELANA (mixta)
Liquor Group Inc.	540712	PARIS DE NUIT
LOJAS RENNER S.A.	541056	ATELIER RE (mixta)
LOLITA SOCIEDAD ANONIMA	541037	LOLITA
LS Corp.	540940	LS E-MOBILITY SOLUTIONS (mixta)
LUCIANO BELLO	541247	ACORN
Luis Pablo Franzini-Battle March	541523	NARCISO UNDERWEAR EXPERTS (mixta)
LUKENOR S.A.	540674	QUALIVITS R DOCTOR FORMULATED (mixta)
LUKENOR S.A.	540673	QUALIVITS R DOCTOR FORMULATED (mixta)
M D A COMÉRCIO E TRANSPORTES DE CEREAIS LTDA	540539	DEUTSCHIPS SEIT 1999 (mixta)
MABLE S.A.	541556	HANK'S POPCORN SABORES GOURMET (mixta)
MAD FOR MODERN S.R.L.	540736	MAD FOR MODERN
Mallinckrodt Pharmaceuticals Ireland Limited	541796	IKARIA
MANTRA S.A.	540886	LUCHO
Manuela Morales	540914	POPACHÍS
Manuela Morales	540917	CLICK
MAPFRE ASISTENCIA, COMPAÑIA INTERNACIONAL DE SEGUROS Y REASEGUROS, S.A.	541089	MAWDY MAPFRE WORLDWIDE DIGITAL ASSISTANCE (mixta)
Mapfre Asistencia, Compañía Internacional de Seguros y Reaseguros, S.A.	541062	MAWDY (mixta)
MARCELO TOCCHETTO	541710	PERSIPLAST
marcia michelis	540898	V F 2020 VIANDAS FIT (mixta)
Marcos Leonardo Chenlo Silva	541419	GOIN (mixta)
Maria Agustina Olivera Couto	540831	OLA

<b>Titular</b>	<b>N° Exp</b>	<b>Marca</b>
Leticia Reiris y María Alegre	541435	D'AMORE MONTESSORI SCHOOL (mixta)
María Belén Carrion Acosta	541514	TERRA TABÚ (mixta)
María Fynn	540836	PEGA HERCULES (mixta)
María Fynn	540835	TODO GANADO (mixta)
MARIA PAULA FERNANDEZ LUZARDO	540644	RINCON DEL PINO GANADERIA Y AGRICULTURA
MARIA PAULA FERNANDEZ LUZARDO	541367	RINCON DEL PINO AGRICULTURA Y GANADERIA (mixta)
MARIO FABIAN ANSELMO	541858	DEFRUTAMADRE (mixta)
Marketplace Investments LLC	541053	(sonora)
Marketplace Investments LLC	541052	(sonora)
Martin Miranda	541080	NEW TAUROS
Martin Pablo Aranda Sojo	541070	COLONIA DEL SACRAMENTO MALL
Mateo Pallares	541628	ALFAPRO
Matias Moreno	541128	DUNKAN BEER (mixta)
MAWELL S.A.	541254	ULTRASTAR
MAWELL S.A.	541255	(figurativa)
Mensa International Limited	541724	MENSA
Meta Platforms, Inc.	541654	REELS
MIGUELIFE S.A.	541679	SHELTER PIZZA
MINISTERIO DE AMBIENTE	540675	URUGUAY SOSTENIBLE (mixta)
MIXPLAY S.A.	541277	DOXTOR (mixta)
MIXPLAY S.A.	541275	BLEO (mixta)
Montres Tudor SA	541460	(figurativa)
MOREIRA BESSO, GERARDO DANIEL	541601	NUTRIYOGA
MOSCA HNOS. S.A.	541752	HOY CLUB DE BENEFICIOS (mixta)
Mundipharma AG	541659	BETAISODONA
NADER COCCARO ALEJANDRO JAVIER	541047	ARQPRO DISEÑO, ARQUITECTURA, BIM (mixta)
NATALIA CECILIA GONZALEZ - MARIA ISABEL MACEDO	540767	BENEIDA TOT ÉS GRÁCIA (mixta)
Natura Laboratorios, S.A. de C.V.	540771	TEC ITALY
Natura Laboratorios, S.A. de C.V.	541756	KÜÜL (mixta)
NATU SAS	541425	NATU (mixta)
NATU SAS	541429	NATU (mixta)
NATU SAS	541427	NATU (mixta)
NATU SAS	541422	NATU (mixta)
NEKIL S.A.	541420	BENSON & THOMAS
NEWAGE INDUSTRIA DE BEBIDAS LTDA.	541840	HIGH ENERGY (mixta)
Nicolas Costa	541462	BAR ANDORRA (mixta)
nicolas Lecuona	541392	SENTO AIKIDO (mixta)
Nintendo of America Inc.	541153	(figurativa)
Nintendo of America Inc.	541158	POKÉTOON
Noelia Yanill Perez Correa	538066	AREQUITA KIDS TURISMO AVENTURA APRENDIZAJE EN LA NATURALEZA (mixta)
Novartis AG	540805	(figurativa)
NTJ INVESTIMENTOS BRASIL LTDA.	541430	FLASH TYRE (mixta)
Okta, Inc.	540696	OKTA
Oldsemen S.A	539751	ROMANITOS
OPRUMIN S.A.	540865	SHARP (mixta)
OPTISOL S.R.L.	540944	BACCUS
ORBIS CONSULTORES SAS	540636	ORBIS FACILITY MANAGEMENT (mixta)

Titular	N° Exp	Marca
ÖZ-KA LASTIK VE KAUÇUK SANAYI TICARET ANONIM SİRKETİ	541715	GTK TYRE (mixta)
Pablo Cassarino	541792	CELUSADO
Pablo Giordano	541315	ARCANUS
Pablo Javier Smiriglia	540720	THE AVOPUNTA COMPANY (mixta)
Pablo Javier Smiriglia	540711	THE AVOCADO COMPANY (mixta)
Mijaël Lichtenstein y Pablo Maman	541502	CUORE
Mijaël Lichtenstein y Pablo Maman	541501	CIPIA
Pacay SRL	540873	STEVIALITE
Pacay SRL	540874	SUCRALITE
Pacay SRL	540872	VEGUY BY DAKOS (mixta)
Pacay SRL	540871	DAKOS ALIMENTOS SIN GLUTEN (mixta)
Pacay SRL	540875	TAMMI BY DAKOS
PAGINAS AMARILLAS S.A.S.	541188	(figurativa)
PARKER-MIGLIORINI INTERNATIONAL DO BRASIL LTDA	541219	CAMPOS DEL PLATA
PASACO S.A.	540608	EJEAS
PASQUET GERSTLE, ANDRES	541146	MERCOPLUS LATAM INVESTIGACIÓN DE MERCADO IMPRESCINDIBLE. (mixta)
PATAGONIA CANDLES S.R.L.	541602	THE CANDLE SHOP AIR BEAUTY (mixta)
PATAGONIA CANDLES S.R.L.	541748	ORGANIC SPA LA ESENCIA DE LA NATURALEZA EN TU HOGAR (mixta)
PAYLOS S.A.	541194	Q ALOPEX
Pentagon S.A.	541339	PENTAGON (mixta)
PEPSICO, INC.	541213	RECARGA TU DIA
YUSUPOFF KLUGMAN, DANIEL JAIME y PÉREZ PASTORINO, PATRICIA VALERIA	541074	PLENITUD (mixta)
PERMODA LTDA	541099	KOAJ (mixta)
PFIZER INC.	541907	LITFULO
PFIZER INC.	541902	ZUWIFTI
Philip Morris Products S.A.	541452	#MAKEHISTORY (mixta)
PLATINA COSMÉTICOS LTDA.	541631	SKALA (mixta)
PLUSUAN, S.A.	540818	RECLUTALIA BY PLUSUAN (mixta)
PPA URUGUAY S.R.L.	541839	SICHER (mixta)
PPG INDUSTRIES OHIO, INC.	540166	PPG (mixta)
PRINX CHENGSHAN (SHANDONG) TIRE COMPANY LTD.	541461	CHENGSHAN (mixta)
Puente Holding Limited	540130	ALTA (mixta)
Quality Is Our Recipe, LLC.	541603	WENDY'S (mixta)
QUESERÍA COLONIA S.R.L	541106	QUESERÍA COLONIA (mixta)
RCN TELEVISIÓN S.A.	540755	RCN ESTUDIOS (mixta)
RCN TELEVISIÓN S.A.	540754	RCN DISTRIBUTION (mixta)
REBECA MARIA REGINA BOSCH	541482	VIP VIAJES (mixta)
REFRICOM URUGUAY SAS	541071	REFRICOM (mixta)
REFRISHOP S.A.	541544	CASA CHALAR
REIMA URUGUAY SAS	540638	REIMA PROTECCIÓN Y SEGURIDAD (mixta)
REPROVITA S.A.S	540749	BIO BANK DONACIÓN DE GAMETOS. (mixta)
REYES MAIRET, NICOLAS Y REYES MAIRET, MATHIAS SOCIEDAD DE HECHO	540372	AIKANA HOMEMADE (mixta)
RISOLTUR S.A.	541199	FEROZ
RM INDÚSTRIA DE CONFECÇÕES LTDA	541426	(figurativa)

Titular	N° Exp	Marca
RM INDÚSTRIA DE CONFECÇÕES LTDA	541424	RUNMORE
ROTOMOLDEOS NUEVA ERA S.A.	541358	NUEVA ERA MARINE
RPAMAKER SAS	540606	RPAMAKER
R&S consumer goods GmbH	540762	MY.SIZE PRO
R&S consumer goods GmbH	540763	MY.SIZE PRO
R&S consumer goods GmbH	540765	LUBE ME
R&S consumer goods GmbH	540766	LUBE ME
Sabiedriba ar ierobežotu atbildību "Baltic Bearing Company-Riga"	540740	BBC-R BALTIC BEARING COMPANY - RIGA (mixta)
Sabiedriba ar ierobežotu atbildību "Baltic Bearing Company-Riga"	540649	BBC-R (mixta)
Samsung Electronics Co., Ltd.	541615	LAUNDRY HUB
SANOFI	540739	S (mixta)
SANOFI	540741	AT SANOFI, WE CHASE THE MIRACLES OF SCIENCE TO IMPROVE PEOPLE'S LIVES
SANTANDER INVESTMENT BANK LIMITED	540632	1ST (mixta)
SANTANDER INVESTMENT BANK LIMITED	540631	FIRST (mixta)
SANTIAGO EZEQUIEL SOTO SILVA	541651	BARAK LANERÍA Y MERCERÍA (mixta)
SANTIAGO SÁNCHEZ BEGINO	541065	SAN CONO UNIVERSITARIO (mixta)
Sara Belén Moyano Da Cunda	541834	ESTER BY SARA MOYANO (mixta)
SATENIL S.A.	541212	NETCOM GLOBAL MEDIA (mixta)
SAUDI ELECTRONIC GAMING HOLDING COMPANY	540384	SAVVY GAMING GROUP
SAUDI ELECTRONIC GAMING HOLDING COMPANY	540385	SAVVY GAMES GROUP
SAUDI ELECTRONIC GAMING HOLDING COMPANY	540383	SAVVY GAMES STUDIO
SAUDI ELECTRONIC GAMING HOLDING COMPANY	540386	SAVVY GAMES FUNDS
SEBASTIAN FERRARI	541678	GAR ZEN (mixta)
Sebastian Osorio	541766	GOLDEN BULL (mixta)
SEDER INDÚSTRIA E COMÉRCIO DE MÓVEIS LTDA.	540483	ORNARE
ServiceRocket Inc.	541637	SERVICEROCKET
SESAMI CASH MANAGEMENT TECHNOLOGIES CORPORATION	541191	SESAMI
SHENZHEN NEW GAIN IMPORT & EXPORT LTD.	540922	WMARK (mixta)
Sietevinte SRL	540815	720 MEDIOS (mixta)
Silvana Steinhauser	540659	GESCHMACK PANIFICACIÓN CON MASA MADRE (mixta)
SIMI BARCELO GASTON	540657	PIRAÑA COAST (mixta)
SKYPOSTAL INC.	541082	SKYPOSTAL SOLUTIONS FOR INTERNATIONAL SHIPPING
Sociedad Anónima Damm	540833	TURIA
SOCIEDADE DE BEBIDAS PANIZZON LTDA.	540423	ROSINA (mixta)
SOCOFAR S.A.	541751	PROVEFARMA (mixta)
SOCUR S.A.	540617	CREDITEL (mixta)
SOFTYS S.A.	541515	NOVA (mixta)



<b>Titular</b>	<b>N° Exp</b>	<b>Marca</b>
SOFTYS S.A.	541513	NOVA
SOLE D'ESTE SAS EN FORMACIÓN	540592	SOLE D'ESTE LUXE RESORT WEAR (mixta)
SONDOR S.A.	540925	LA KARIBE (mixta)
SONY MUSIC ENTERTAINMENT	540811	FILTR SUR (mixta)
STARBUCKS CORPORATION	539141	CLOVER VERTICA
SUCCESSPROD S.R.L.	540974	SUCCESSPROD (mixta)
SUCESIÓN RAMÓN SÁNCHEZ NOGUEIRA LIMITADA	541568	TOKIO
SUCESIÓN RAMÓN SÁNCHEZ NOGUEIRA LIMITADA	541569	BERLÍN
SUCESIÓN RAMÓN SÁNCHEZ NOGUEIRA LIMITADA	541570	NAIROBI
SUCESIÓN RAMÓN SÁNCHEZ NOGUEIRA LIMITADA	541571	ESTOCOLMO
SUCESIÓN RAMÓN SÁNCHEZ NOGUEIRA LIMITADA	541572	BOGOTA
SUCESIÓN RAMÓN SÁNCHEZ NOGUEIRA LIMITADA	541573	LISBOA
SUCESIÓN RAMÓN SÁNCHEZ NOGUEIRA LIMITADA	541536	EMBAJADORES CIGARRERÍA E DESDE 1899 ARTICULOS FINOS PARA FUMADORES (mixta)
SUCESIÓN RAMÓN SÁNCHEZ NOGUEIRA LIMITADA	541575	MARSELLA
SUCESIÓN RAMÓN SÁNCHEZ NOGUEIRA LIMITADA	541576	MOSCU
SUCESIÓN RAMÓN SÁNCHEZ NOGUEIRA LIMITADA	541577	BLANQUILLO
SUCESIÓN RAMÓN SÁNCHEZ NOGUEIRA LIMITADA	541578	ACUARELA
SUCESIÓN RAMÓN SÁNCHEZ NOGUEIRA LIMITADA	541582	CAIGUA
SUCESIÓN RAMÓN SÁNCHEZ NOGUEIRA LIMITADA	541574	HELSINKI
SUCESIÓN RAMÓN SÁNCHEZ NOGUEIRA LIMITADA	541579	RAICES
SUCESIÓN RAMÓN SÁNCHEZ NOGUEIRA LIMITADA	541581	CONXO
SUCESIÓN RAMÓN SÁNCHEZ NOGUEIRA LIMITADA	541580	TRINQUETILLA
Suzuki Motor Corporation	541414	S SUZUKI (mixta)
SYNGENTA CROP PROTECTION AG	541248	NATURE BUILT IN
TAIZHOU ROSEW MACHINERY CO.,LTD.	541600	R ROSEW HIGH TECHNOLOGY (mixta)
TCL Technology Group Corporation	541144	INSPIRE GREATNESS
TELEFONICA MOVILES DEL URUGUAY S.A.	540895	PREPACK
TELESUD S.A.	541848	FULLCARGO (mixta)
The Gillette Company LLC	540759	SPORT PEAK
The Liverpool Football Club and Athletic Grounds Limited	540820	LIVERPOOL FOOTBALL CLUB (mixta)
The Liverpool Football Club and Athletic Grounds Limited	540821	LFC (mixta)
THE POLO/LAUREN COMPANY, L.P.	541150	RALPH'S COFFEE
The Polo/LAUREN Company L.P.	541147	POLO

Titular	N° Exp	Marca
The Polo/LAUREN Company L.P.	541149	RALPH LAUREN
The Polo/LAUREN Company L.P.	541148	(figurativa)
TNIN SHOES CALÇADOS E ACESSÓIOS LTDA	541095	TNIN (mixta)
TONICOR S.A.	541115	LA CHACRA SUPERMERCADO (mixta)
TRADETOP S.R.L.	541655	INDRA
TRAVEL RESERVATIONS S.R.L.	541539	D DESPEGAR TRAVEL SHOW (mixta)
Tritón Comunicaciones, S.A. de C.V.	539853	N+ (mixta)
Tritón Comunicaciones, S.A. de C.V.	539854	N+ (mixta)
Triumph Designs Limited	541073	TRIUMPH (mixta)
Triumph Designs Limited	541072	TRIUMPH
TTS VIAJES S.A.	541697	TRAVEL SERVICES (mixta)
TVLX Viagens e Turismo S.A.	541428	VIAJANET (mixta)
Uber Technologies, Inc.	541474	UBER ENCARGO
VALERIA GONZALEZ	541395	ONAH ESTÉTICA
COMESAÑA JORCIN, PATRICIA SILVIA y VARELA OTAMENDI, MARÍA	540797	MY CROWN (mixta)
Venus Medtech (Hangzhou) Inc.	541664	VENUSA-VALVE
Venus Medtech (Hangzhou) Inc.	541661	VENUSMEDTECH
Venus Medtech (Hangzhou) Inc.	541663	VENUSP-VALVE
Venus Medtech (Hangzhou) Inc.	541666	(figurativa)
Venus Medtech (Hangzhou) Inc.	541667	VENUSA-PRO
Vertex Pharmaceuticals Incorporated	540824	ORKAMBI
Vertex Pharmaceuticals Incorporated	540827	KALYDECO (mixta)
Vertex Pharmaceuticals Incorporated	540826	KALYDECO
Vertex Pharmaceuticals Incorporated	540825	ORKAMBI (mixta)
VFS Global Services PLC	540396	VFS. - VFS. GLOBAL EST.2001 (mixta)
Virginia Chivetti	541557	VIÑAS DEL QUINTÓN (mixta)
Virginia Chivetti	541849	QUINTÓN ENOTURISMO
VIRGINIA LIA JACOBS	540817	HENNIA
VIRGINIA LIA JACOBS	541087	ADULT CARE
VRIO CORP.	541830	D GO (mixta)
Vrio Corp.	541475	DIRECTV FIBRA (mixta)
Vrio Corp.	541472	D FIBRA (mixta)
WERT SAS	540553	GPSYA
WHIRLPOOL PROPERTIES, INC.	541162	SWASH
Widex A/S	541066	(figurativa)
Widex A/S	541064	HEAR (mixta)
WOTRAY S.A.	540774	DEBATE (mixta)
XFLIGHT LLC	541736	XFLIGHT (mixta)
Xiamen C&D Corporation Limited	540211	C&D (mixta)
Xiamen C&D Corporation Limited	540210	(figurativa)
ZAMCA S.A.	540943	BOK (mixta)
Zhejiang Chint Electrics Co., Ltd.	541810	CHINT GLOBAL (mixta)
ZHEJIANG GEELY HOLDING GROUP CO., LTD.	541138	ZEEKR (mixta)
ZHEJIANG GEELY HOLDING GROUP CO., LTD.	541638	(figurativa)
ZHEJIANG GEELY HOLDING GROUP CO., LTD.	541639	LIVAN (mixta)
Zhejiang Qianjiang Motorcycle Co., Ltd.	541281	QJIANG (mixta)
Zhejiang Qianjiang Motorcycle Co., Ltd.	541279	Q (mixta)

<b>Titular</b>	<b>N° Exp</b>	<b>Marca</b>
Zhejiang Rifeshow Cosmetics Co., Ltd.	540866	AIRBODY (mixta)
ZHU XIAOZHONG	540718	FREY (mixta)
ZODIAC INTERNATIONAL CORPORATION	540906	TAMIGRON
ZODIAC INTERNATIONAL CORPORATION	540905	PAZINAL
ZODIAC INTERNATIONAL CORPORATION	540907	EPLINA
ZONAMERICA S.A.	541192	BOSCO (mixta)
ZONAMERICA S.A.	541195	BOSCO (mixta)

### ***ÍNDICE POR TITULARES DE FRASES PUBLICITARIAS***

<b>Titular</b>	<b>N° Exp</b>	<b>Marca</b>
Izder Advisors S.A.	541011	SÉ MÁS INTENSAMENTE TÚ
PLUSUAN, S.A.	540828	TU CARRERA DESPEGA AQUÍ
SUZANO S.A.	541922	SUZANO NOSOTROS PLANTAMOS EL FUTURO (mixta)
THE COCA-COLA COMPANY	541618	ELIGE LA BOTELLA RETORNABLE. ELIGE CUIDAR EL PLANETA

### ***ÍNDICE POR TITULARES DE MARCAS DE CERTIFICACIÓN***

<b>Titular</b>	<b>N° Exp</b>	<b>Marca</b>
INSTITUT DE RECERCA I TECNOLOGIA AGROALIMENTARIES (IRTA)	540642	W WELFAIR (mixta)

## *ÍNDICE*

Listado de Códigos Utilizados en el Boletín.....	7
Listado de Agentes de la Propiedad Industrial .....	11
Solicitudes de Marcas .....	25
Solicitudes de Frases Publicitarias .....	213
Solicitudes de Marcas de Certificación .....	214
Resoluciones de Marcas, Concedidas.....	215
Resoluciones de Frases Publicitarias, Concedidas .....	277
Resoluciones de Marcas, desestimadas .....	278
Resoluciones de Marcas, desestimadas (Art. 92, D. 34/999).....	280
Resoluciones de Marcas, desistidas (Art. 90, D. 34/999).....	280
Resoluciones de Marcas, desistidas (Art. 92, D. 34/999).....	281
Resoluciones de Frases Publicitarias, desistidas (Art. 92, D. 34/999) .....	282
Resoluciones de Renovaciones, desistidas (Art. 92, D. 34/999) .....	282
Resoluciones de Marcas, Modificadas.....	283
Resoluciones de Marcas, Anuladas .....	283
Resoluciones de Renovaciones, Modificadas .....	283
Resoluciones de Renovaciones, Anuladas .....	283
Resoluciones de Renovaciones, Concedidas.....	284
Resoluciones de Renovaciones de Frases Publicitarias, Concedidas.....	337
Resoluciones de Peticiones, Modelos de Utilidad .....	337
Transferencias.....	337
Transferencias Parciales .....	361
Transferencias de Frases Publicitarias .....	361
Transferencias de Patentes .....	362
Cambios de Nombre .....	363
Cambios de Nombre de Patentes.....	369
Cambios de Domicilio.....	370
Cambios de Domicilio de Frases Publicitarias .....	385
Reinscripciones de Embargos.....	386
Inscripciones de Renuncias Parciales.....	386
Resoluciones de Recursos, DNPI .....	386
Resoluciones de Recursos de Modelos de Utilidad, DNPI .....	386
Resoluciones de Patentes, Concedidas .....	386
Resoluciones de Diseños Industriales, Concedidas .....	389
Resoluciones de Modelos de Utilidad, Concedidas .....	390
Resoluciones de Patentes, desestimadas.....	390
Resoluciones de Diseños Industriales, desestimadas.....	391
Resoluciones de Modelos de Utilidad, desestimadas.....	391
Resoluciones de Patentes, desistidas.....	391
Resoluciones de Diseños Industriales, desistidas.....	392
Resoluciones de Patentes, Abandonadas.....	392
Resoluciones de Modelos de Utilidad, Abandonadas.....	393
Notificaciones de Asesoría.....	394

Notificaciones de Recursos.....	399
Solicitudes de Patentes de Invención.....	404
Solicitudes de Diseños Industriales.....	452
Solicitudes de Modelos de Utilidad.....	466
Índice por Titulares de Marcas.....	469
Índice por Titulares de Frases Publicitarias.....	482
Índice por Titulares de Marcas de Certificación.....	482
Índice.....	483

**Depósito legal 325.532**  
**(N° 276)**  
**Impreso en D.N.P.I.**  
**E-mail: [administracion.dnpi@miem.gub.uy](mailto:administracion.dnpi@miem.gub.uy)**  
**Rincón 719 Telefax 2840 1234**  
**C.P. 11.000**  
**Montevideo – Uruguay**

**Montevideo, 30 de setiembre de 2022**

**Setiembre 2022**