

REPUBLICA ORIENTAL DEL URUGUAY

MINISTERIO DE INDUSTRIA, ENERGIA Y MINERIA

DIRECCION NACIONAL DE LA PROPIEDAD INDUSTRIAL

BOLETIN

de la

Propiedad Industrial

N° 277

31 de Octubre de 2022

República Oriental del Uruguay



Ministerio
**de Industria,
Energía y Minería**

*Dirección Nacional de la
Propiedad Industrial*

BOLETÍN

**DE LA PROPIEDAD
INDUSTRIAL**

ISSN 2301 – 1777
Impreso en D.N.P.I.
Permiso N° 2160 (Biblioteca Nacional)
URUGUAY

REPÚBLICA ORIENTAL DEL URUGUAY



MINISTERIO DE INDUSTRIA, ENERGÍA Y MINERÍA

DIRECCIÓN NACIONAL DE LA PROPIEDAD INDUSTRIAL

ING. OMAR PAGANINI

MINISTRO DE INDUSTRIA, ENERGÍA Y MINERÍA

SR. WALTER VERRI

SUBSECRETARIO

MINISTERIO DE INDUSTRIA, ENERGÍA Y MINERÍA

DR. JUAN PABLO BORGES

DIRECTOR GENERAL DE SECRETARÍA

MINISTERIO DE INDUSTRIA, ENERGÍA Y MINERÍA

DR. SANTIAGO MARTÍNEZ MORALES

DIRECTOR TÉCNICO DE LA PROPIEDAD INDUSTRIAL

MINISTERIO DE INDUSTRIA, ENERGÍA Y MINERÍA

de acuerdo a lo establecido por los artículos 80 y 101 de la Ley
N° 17.011 de fecha 25 de Setiembre de 1998 ésta es la
Publicación Oficial de la Dirección Nacional de la Propiedad
Industrial, Unidad Ejecutora del Ministerio de Industria, Energía
y Minería, cuyo cometido sustantivo es administrar y proteger el
derecho de la Propiedad Industrial.

RINCON 719 – Teléfono 2900 0658 – C.P. 11.000

e-mail: secretaria.dnpi@miem.gub.uy

<http://www.miem.gub.uy>

LISTADO DE CÓDIGOS UTILIZADOS EN EL BOLETÍN

LISTA DE CÓDIGOS, POR ORDEN ALFABÉTICO, Y LOS NOMBRES CORRESPONDIENTES (ABREVIADOS) DE ESTADOS, OTRAS ENTIDADES Y ORGANIZACIONES INTERGUBERNAMENTALES.

AD	ANDORRA	CS	SERBIA Y MONTENEGRO
AE	EMIRATOS ARABES UNIDOS	CU	CUBA
AF	AFGANISTAN	CV	CABO VERDE
AG	ANTIGUA Y BARBUDA	CY	CHIPRE
AI	ANGUILLA	CZ	REPUBLICA CHECA
AL	ALBANIA		
AM	ARMENIA	DE	ALEMANIA
AN	ANTILLAS NEERLANDESAS	DJ	DJIBOUTI
AO	ANGOLA	DK	DINAMARCA
AP	ORGANIZACIÓN REGIONAL AFRICANA DE LA PROPIEDAD INDUSTRIAL (ARIPO)	DM	DOMINICA
AR	ARGENTINA	DO	REPUBLICA DOMINICANA
AT	AUSTRIA	DZ	ARGELIA
AU	AUSTRALIA		
AW	ARUBA	EA	ORGANIZACIÓN EUROASIÁTICA DE PATENTES (EAPO)
AZ	AZERBAIYAN	EC	ECUADOR
		EE	ESTONIA
BA	BOSNIA Y HERZEGOVINA	EG	EGIPTO
BB	BARBADOS	EH	SAHARA OCCIDENTAL
BD	BANGLADESH	EM	OFICINA PARA LA ARMONIZACIÓN DEL MERCADO INTERIOR (MARCAS Y DIBUJOS Y MODELOS) (OAMI)
BE	BELGICA	EP	OFICINA EUROPEA DE PATENTES (OEP)
BF	BURKINA FASO	ER	ERITREA
BG	BULGARIA	ES	ESPAÑA
BH	BAHREIN	ET	ETIOPIA
BI	BURUNDI		
BJ	BENIN	FI	FINLANDIA
BM	BERMUDA	FJ	FIJI
BN	BRUNEI DARUSSALAM	FK	ISLAS FALKLAND (MALVINAS)
BO	BOLIVIA	FO	ISLAS FEROE
BR	BRASIL	FR	FRANCIA
BS	BAHAMAS		
BT	BHUTAN	GA	GABON
BV	ISLA BOUVET	GB	REINO UNIDO
BW	BOTSWANA	GC	OFICINA DE PATENTES DEL CONSEJO DE COOPERACION DE LOS ESTADOS ARABES DEL GOLFO (CCG)
BX	OFICINA BENELUX DE MARCAS (BBM) Y OFICINA BENELUX DE DIBUJOS Y MODELOS (BBDM)		
BY	BELARUS	GD	GRANADA
BZ	BELICE	GE	GEORGIA
		GH	GHANA
CA	CANADA	GI	GIBRALTAR
CD	REPUBLICA DEMOCRATICA DEL CONGO	GL	GROENLANDIA
CF	REPUBLICA CENTROAFRICANA	GM	GAMBIA
CG	CONGO	GN	GUINEA
CH	SUIZA	GQ	GUINEA ECUATORIAL
CI	COTE D'IVOIRE	GR	GRECIA
CK	ISLAS COOK	GS	ISLAS GEORGIA DEL SUR Y SANDWICH DEL SUR
CL	CHILE	GT	GUATEMALA
CM	CAMERUN	GW	GUINEA - BISSAU
CN	CHINA	GY	GUYANA
CO	COLOMBIA	HK	REGION ADMINISTRATIVA ESPECIAL DE HONG KONG DE LA REPUBLICA POPULAR DE CHINA
CR	COSTA RICA		

HN	HONDURAS	MZ	MOZAMBIQUE
HR	CROACIA	NA	NAMIBIA
HT	HAITI	NE	NIGER
HU	HUNGRIA	NG	NIGERIA
IB	OFICINA INTERNACIONAL DE LA ORGANIZACIÓN MUNDIAL DE LA PROPIEDAD INTELECTUAL (OMPI)	NI	NICARAGUA
ID	INDONESIA	NL	PAISES BAJOS
IE	IRLANDA	NO	NORUEGA
IM	ISLA DE MAN	NP	NEPAL
IL	ISRAEL	NR	NAURU
IN	INDIA	NZ	NUEVA ZELANDIA
IQ	IRAQ	OA	ORGANIZACION AFRICANA DE LA PROPIEDAD INTELECTUAL (OAPI)
IR	IRAN(REPUBLICA ISLAMICA DEL)	OM	OMAN
IS	ISLANDIA	PA	PANAMA
IT	ITALIA	PE	PERU
JM	JAMAICA	PG	PAPUA NUEVA GUINEA
JO	JORDANIA	PH	FILIPINAS
JP	JAPON	PK	PAKISTAN
KE	KENYA	PL	POLONIA
KG	KIRGUISTAN	PT	PORTUGAL
KH	CAMBOYA	PW	PALAU
KI	KIRIBATI	PY	PARAGUAY
KM	COMORAS	QA	QATAR
KN	SAINT KITTS Y NEVIS	RO	RUMANIA
KP	REPUBLICA POPULAR DEMOCRATICA DE COREA	RS	SERBIA
KR	REPUBLICA DE COREA	RU	FEDERACION DE RUSIA
KW	KUWAIT	RU	FEDERACION DE RUSIA
KY	ISLAS CAIMAN	RW	RWANDA
KZ	KAZAKSTAN	SA	ARABIA SAUDITA
LA	REPUBLICA DEMOCRATICA POPULAR LAO	SB	ISLAS SALOMON
LB	LIBANO	SC	SEYCHELLES
LC	SANTA LUCIA	SD	SUDAN
LI	LIECHTENSTEIN	SE	SUECIA
LK	SRI LANKA	SG	SINGAPUR
LR	LIBERIA	SH	SANTA HELENA
LS	LESOTHO	SI	ESLOVENIA
LT	LITUANIA	SK	ESLOVAQUIA
LU	LUXEMBURGO	SL	SIERRA LEONA
LV	LETONIA	SM	SAN MARINO
LY	JAMAHIRIYA ARABE LIBIA	SN	SENEGAL
MA	MARRUECOS	SO	SOMALIA
MC	MONACO	SR	SURINAME
MD	REPUBLICA DE MOLDOVA	ST	SANTO TOME Y PRINCIPE
ME	MONTENEGRO	SV	EL SALVADOR
MG	MADAGASCAR	SY	REPUBLICA ARABE SIRIA
MK	EX REPUBLICA YUGOSLAVA DE MACEDONIA	SZ	SWAZILANDIA
ML	MALI	TC	ISLAS TURCOS Y CAICOS
MM	MYANMAR	TD	CHAD
MN	MONGOLIA	TG	TOGO
MO	MACAO	TH	TAILANDIA
MP	ISLAS MARIANAS SEPTENTRIONALES	TJ	TAYIKISTAN
MR	MAURITANIA	TM	TURKMENISTAN
MS	MONTSERRAT	TN	TUNEZ
MT	MALTA	TO	TONGA
MU	MAURICIO	TP	TIMOR ORIENTAL
MV	MALDIVAS	TR	TURQUIA
MW	MALAWI	TT	TRINIDAD Y TOBAGO
MX	MEXICO	TV	TUVALU
MY	MALASIA		

TW	TAIWAN, PROVINCIA DE CHINA	VN	VIET NAM
TZ	REPUBLICA UNIDA DE TANZANIA	VU	VANUATU
UA	UCRANIA	WO	ORGANIZACIÓN MUNDIAL DE LA PROPIEDAD INTELLECTUAL (OMPI) (OFICINA INTERNACIONAL DE)
UG	UGANDA	WS	SAMOA
US	ESTADOS UNIDOS DE AMERICA	YE	YEMEN
UY	URUGUAY	ZA	SUDAFRICA
UZ	UZBEKISTAN	ZM	ZAMBIA
VA	SANTA SEDE	ZW	ZIMBABWE
VC	SAN VICENTE Y LAS GRANADINAS		
VE	VENEZUELA		
VG	ISLAS VIRGENES (BRITANICAS)		

MARCAS (Norma OMPI St. 60)

- (210) – Número de Solicitud.
- (730) – Nombre y dirección del solicitante o titular del Registro.
- (220) – Fecha de presentación de la solicitud.
- (511) – Clase y/o Producto o Servicio protegido (Clasificación de Niza) (Novena Edición).
- (540) – Reproducción de la Marca.
- (300) – Datos relativos a la prioridad en virtud del Convenio de la Unión de París (Número asignado a la primera solicitud, fecha de presentación de la primera solicitud, código de la Norma Ompi St 3 de la Oficina nacional o regional donde se presentó la primera solicitud).

- (591) – Información relativa a los colores reivindicados.
- (551) – Indicación de que la marca es una marca colectiva o una marca de certificación o garantía.
- (554) – Marca tridimensional.
- (556) – Marca sonora, incluidas las características.
- (740) - Datos del Agente de la Propiedad Industrial.

PATENTES Y MODELOS DE UTILIDAD (Norma OMPI St. 9)

- (21) - Número de la solicitud de Invención o Modelo de Utilidad.
- (22) - Fecha de presentación de la solicitud.
- (12) - Designación del tipo de documento.
- (71) - Datos del solicitante, incluyendo nombre y país de origen.
- (72) - Nombre del Inventor/es.
- (51) - Clasificación Internacional de Patentes (Clasificación de Estrasburgo) (Sexta Edición).
- (54) - Título de la Invención.
- (57) - Resumen y diseño de la invención o descripción del modelo de utilidad o diseño (no más de 100 palabras).
- (74) - Nombre del Agente de la Propiedad Industrial.
- (30) - Datos relativos a la prioridad en virtud del Convenio de la Unión de París.
- (31) - Número asignado a la solicitud prioritaria o reválida.
- (32) - Fecha de depósito de la solicitud prioritaria.
- (33) - Código de la Norma St. 3 de Ompi que identifica a la Oficina de Propiedad Industrial que ha atribuido el número a la solicitud prioritaria o de la Organización que ha atribuido el número de la solicitud regional prioritaria (para las solicitudes internacionales registradas en virtud del PCT, debe utilizarse el Código "WO").

A continuación del número de la solicitud correspondiente (Código 21), deberá aplicarse el código normalizado para la identificación de los diferentes tipos de documentos de patentes (Norma Ompi St. 16):

A1: Invención Primaria

U: Modelo de Utilidad

DISEÑOS Y MODELOS INDUSTRIALES (Norma OMPI St. 80)

- (21) - Número de la solicitud del diseño o modelo industrial.
- (22) - Fecha de presentación de la solicitud.
- (12) - Designación del tipo de documento.
- (71) - Datos del solicitante, incluyendo nombre y país de origen.
- (72) - Nombre del creador/es.
- (51) - Clasificación Internacional para los Dibujos y Modelos Industriales (Clasificación de Locarno) (Sexta Edición).
- (54) - Título del Diseño o Modelo.
- (57) - Resumen y descripción del diseño o modelo industrial incluidas las indicaciones de colores (no más de 100 palabras).
- (74) - Nombre del Agente de la Propiedad Industrial.
- (30) - Datos relativos a la prioridad en virtud del Convenio de la Unión de París.
- (31) - Número asignado a la solicitud prioritaria o reválida.
- (32) - Fecha de depósito de la solicitud prioritaria.
- (33) - Código de la Norma St. 3 de Ompi identificando a la Oficina nacional o regional u organización en la que se presentó la solicitud prioritaria (para los depósitos internacionales presentados en virtud del Arreglo de La Haya, se debe utilizar el Código "WO"). A continuación del número de la solicitud correspondiente (Código 21) deberá aplicarse el código normalizado para la identificación de los diferentes tipos de documentos (Norma OMPI St. 17):

Q: Diseños y Modelos Industriales

Listado de Agentes de la Propiedad Industrial

Nro	Nombre	Dirección	CP	Teléfono	Fax	E-mail
3	CIKATO LAY, MANFREDO ANDRES	Araucana 1277	11400	2606.06.06	2606.14.39	cikato@cikato.com.uy
6	MARINARI SEXTO, WALTER HUGO	25 de Mayo 576	11000	2916.34.55	2916.21.93	bacot@bacot.com.uy
8	ARROLI TELESCA, RUBEN JOSE	Ituzaingó 1485 esc.12	11000	2915.94.75		
12	FREIRA SERRAT, CARLOS MARIA	Río Negro 1394 piso 10 esc.10	11100	2901.16.70/ 2901.58.32		
15	DAIQUI BALMACEDA, JUAN CARLOS	Río Negro 1394 piso 10 esc.10	11100			
16	GIMENEZ SORHUET, ROBERTO DARIO	Florida 1485 ap.301	11000	2901.22.78		
17	PONCE DE LEON MURO, JULIO CESAR	Florida 1485 ap.301	11000	2901.22.78		
18	BACOT SILVEIRA, OSCAR TULIO	25 de Mayo 576	11000	2916.34.69	2916.21.93	obacot@bacot.com.uy
19	FREIRA SERRAT, JUAN MIGUEL	Plaza Cagancha 1335 esc. 317/18	11100	2900.06.86	2908.71.27	jmfreira@adinet.com.uy
20	FOX TAYLOR, NORMAN ALEXANDER	Pedro Murillo 6136	11500	2604.03.60	2604.66.69	nfox@fox.com.uy
21	LAMAS BALESTRA, MARIO DANIEL	Lucerna 6273	11400	2600.37.67		dlamas@lamasgrimaldi.com.uy
23	BONADA ASUAGA, ROBERTO GUZMAN	Lancasteriana 2359 bis	11400	2600.72.24		
24	LANZON MAZZELLO, RAFAEL EDUARDO	Brandzen 1961 esc.102	11200	2408.50.38	2409.97.61	rlanzon@lanz.com.uy
25	PIÑEYRO CAMACHO, MARTHA NELIDA	Plaza Independencia 848 1er. Piso	11000	2908.81.36		mpineyro@montevideo.com.uy
26	VECINO SANCHEZ, GERMAN	Mones Roses 6937	11500	2604.16.04	2604.66.04	gvecino@ppv.com.uy
28	MEDINA YLLA, EDUARDO JOSE	Av. Garibaldi 2185		2203.93.06/ 2209.51.40	2200.74.74	info@medinamarcas.com
29	PITTALUGA SHAW, JUAN ANTONIO	Echevarriarza 3535 Of. 1601 Torre A	11300	2623.29.59	2623.29.57	juan@pittaluga.com
30	MAESO VALINO, MARIA CRISTINA	Colonia 1825 apto.402				
31	PILAS SEMICHEVICH, RODOLFO	Av. Uruguay 2049 bis	11100	2409.36.02	2401.55.72	uruguay@pilasnet.com.uy

Nro	Nombre	Dirección	CP	Teléfono	Fax	E-mail
32	MELGAR PEREZ, ASTUR EULOGIO	Av. Uruguay 1826	11100	2409.17.00	2402.30.55	
34	FERNANDEZ SECCO, GONZALO JOSE	25 de Mayo 467 piso 5	11000	2916.19.13	2916.57.40	gonzalo@fernandezsecco.com.uy
35	D' ALESSANDRO VALIDO, JULIO CESAR	Juan Paullier 2015	11200	2400.39.70		
37	FERNANDEZ PEREZ, EDUARDO LUIS	Fernández Crespo 1861 bis	11200	2400.22.90	2400.22.90	eduardoluisf@gmail.com
38	BOGNANNO PAULOS, NOEMI CLARA	Rincón 682 esc.14	11000	2916.38.72		
39	CROCCO MARTINEZ, ALVARO HARRIET	Av. Garibaldi 2276		2200.74.24		
40	MORGADE DI POLITO, CLAUDIO	Av. de las Américas 8336, Block 1, Ap.101	15000	094.429.107		cmorgade@morgade.uy
41	DELPIAZZO RODRIGUEZ, CARLOS ENRIQUE	Misiones 1424 piso 5	11000	2915.30.30	2915.30.30 int. 512	delpiazzo@delpiazzo.com.uy
42	ARGENTINO DE BELLO, ROSARIO NELLY	Juncal 1431 esc. 402	11000	-		
43	AURUCCI DE MORALES, SYLVIA RITA	25 de Mayo 395 piso 3 apto.6	11000	-		
44	SAAVEDRA LEVRATTO, LORENZO	Zapicán 2980-82		2209.46.83		
45	DOCAMPO EIRIN, ALBERTO MARIO	Rivera 6056		2600.39.41		
46	EIRIN DI FAZIO, ALVARO JORGE	Plaza Independencia 831 esc. 609	11300	2902.75.49	2902.35.51	
47	PISANI PALMER, CARLOS ORLANDO	R. Hayadelat 1688		2619.63.77		
48	MONTANO GOMEZ, PEDRO JULIO	Plaza Cagancha 1335 ap. 1104	11100	2903.07.80	2903.07.80 int. 211	sym@scelzaymontano.com.uy
49	ORDOQUI CASTILLA, GUSTAVO ANTONIO	Rincón 728	11000	2708.38.03		gustavo@ordoquicastilla.com
50	CORTI ACOSTA, GRACIELA BEATRIZ	Obligado 1070	11300	2709.30.95		gcorti@adinet.com.uy
51	SCELZA MARTINEZ, FERNANDO LUIS	Rba. Rep. del Perú 1043	11300	2708.29.50		
52	PRAT GUTIERREZ, AGUSTIN JULIO	Palacio Lapido Av. 18 de julio 948 ap.401	11100	29047739		pratasoc@usa.net
53	APEZECHEA SANTINI, JOSE ANTONIO	Colonia 2108 apto.701	11200	2408.43.08		
54	NAVARRO CASTEX, ALEJANDRO	Pza. Independencia 1374	11100	2902.42.16		

Nro	Nombre	Dirección	CP	Teléfono	Fax	E-mail
	MARIANO					
55	RODRIGUEZ TURRINA, LUIS ALBERTO	Río Negro 1380	11100	2908.50.62		
56	CAGNOLA MERCADAL, CARLOS	La Paz 1988		2400.56.95		
57	IRIGOYEN DESCALZI, JOSE MARTÍN	25 de Mayo 635 esc. 203	11000	2916.03.37		
58	SANJINES RAVIZZA, CRISTOBAL ERNESTO	Duvimioso Terra 2327 apto. 6	11200	-		
59	MUSSIO TORRES, DIEGO EDUARDO	J.M.Blanes 869	11200	2413.65.67		
61	BALLIVA GIMENEZ, WASHINGTON ULISES	Rincón 540 piso 7	11000	-		
62	ZARUCKI ABRAMODICAS, JAIME	Bulevar Artigas 515 apto. 301	11300	-		
63	POPLAWSKI NATANSON, LIZABETH	Maldonado 2422 apto. 21	11200	-		
64	GAMUNDI DEMARCO, GERARDO ANIBAL	José Benito Lamas 2792	11300	-		
65	MARTINEZ LEONI, JOSE LUIS	Brandzen 1961 esc.602	11200	2407.81.72	2407.81.75	jose@martinezleoni.com.uy
66	DE POSADAS MONTERO, DIEGO ANTONIO	Rincón 454 esc. 316	11000	-		
67	MAYER MARTINEZ, FEDERICO OSCAR	Ituzaingó 1393 esc. 503	11000	-		
68	MOREIRA PIEGAS, ROBERTO	Colonia 981 esc. 604	11100	2900.34.71	2900.86.22	moreirap@adinet.com.uy
69	FONT BERTINAT, BISMARCK ENRIQUE	Av. Uruguay 872	11100	2902.55.65/ 2902.55.67		
70	ZAS FERNANDEZ, JORGE	Ejido 1425 esc. 3	11100	-		
71	LAURNAGA MARANA, VICTORIO JORGE	Bulevar España 2575 apto. 302	11300	-		
72	COSTA ALBERTONI, NEDER ERNESTO	25 de mayo 477 esc. 28	11000	-		
74	LAMAS MORENO, LUIS FLORENCIO	Ramón Massini 3304 apto. 403	11300	2708.47.61		
75	CHIARINO MAÑE, ARMANDO	García de Zúñiga 2265	11300	2711.07.77		
76	SUAREZ ANTOLA, GRISELDA	18 de Julio 1805		2409.26.80		

Nro	Nombre	Dirección	CP	Teléfono	Fax	E-mail
77	STRAPETTI MONTESANO, HUGO	Av. Agraciada 2955 apto.106		-		
78	FERNANDEZ GOYECHEA, LUIS ENRIQUE	25 de Mayo 467 piso 4 esc. 7	11000	-		
79	MACIEL PAPP, GUILLERMO HORACIO	Santiago Vázquez 1244 of. 502	11300	2916.34.55		
80	STEFANOLI PESCIETTO, ALEJANDRO	Juan Benito Blanco 1127 apto. 101	11300	2709.04.45		
81	FLORES CASTRO, GALA DEL CARMEN	Bulevar Artigas 3942 apto. 1		-		
82	HERVI BARROS, CARLOS ROGELIO	Dalmiro Costa 4486 apto. 2	11400	2619.55.94		
83	D' ALBORA SOLARI, FELIPE CONRADO	Dr. Francisco Soca 1360	11300	2708.11.20		
84	STEFANOLI PESCIETTO, MARIO FIDEL	Andes 1111	11100	2908.59.38		
85	FIGUEREDO MARTINEZ, OSCAR MARIO	25 de Mayo 477 esc. 50	11000	-		
86	INVIDIO MAURIELLO, SANTIAGO RODOLFO	25 de Mayo 661 esc. 205	11000	-		
87	ORLANDO SANTA MARIA, MARIA LORELEY	Juan Paullier 2416	11200	-		
89	FERRAZ MADRID, JOSE PEDRO	Juncal 1408 piso 5 esc. 9	11000	-		
90	ENRIQUEZ FIGOLI, JORGE RUBEN	Misiones 1371 piso 1 esc. 8	11000	-		
92	MENDEZ MANOVSKY, RUPERTO ALVARO	Tacuarembó 1442	11200	2402.90.96		
93	CANTON POMBO, MARCELO	Treinta y Tres 1420 piso 2 esc.15	11000	2916.52.25		
94	FISCHER FLEURQUIN, GUSTAVO RODOLFO	San José 807 Of. 403	11100	2908.71.67	2908.35.58	fischer@fischer.com.uy
95	VIANA FERREIRA, ENRIQUE ALIPIO	Av. Uruguay 1824 apto. 202	11200	-		
96	MONTORO HEGUERTE, FRANCISCO EDISON	Treinta y Tres 1374 esc.108	11000	2915.94.27		
97	FINALI PILAS, MIRYAM ROSSANA	Av. Uruguay 2049	11100	2409.36.02	2401.55.72	uruguay@pilasnet.com.uy
98	VILLAGRAN MERA, CLAUDIA	Juncal 1398 piso 4 esc.4/40	11000	-		

Nro	Nombre	Dirección	CP	Teléfono	Fax	E-mail
99	HENDLER TRIADOR, GABRIELA	Juncal 1395 esc.42	11000	-		
101	MARTINONI OTORMIN, GUSTAVO EDUARDO	Av. Brasil 2986 Of. 409, Torre Parque Sabato	11300	2707.75.18	2707.56.46	gustavomartinoni@martinoniyrodriguez.com
103	ABENTE LE BAS, DIEGO MONTGOMERY	Araucana 1277	11400	2606.06.06	2606.14.39	cikato@cikato.com.uy
104	PILAS PEREIRA, RODOLFO	Av. Uruguay 2049	11100	2409.36.02	2401.55.72	uruguay@pilas.com.uy
105	GERONA COSIO, HECTOR RICARDO	Colonia 815 esc. 504	11100	2901.36.08	2901.36.08	
106	GAMIO CIA, JUAN ENRIQUE	Misiones 1379 esc. 601	11000	-		
107	GUTIERREZ CARRAU, JUAN MANUEL	Rincón 528 Piso 6	11000	2916.50.94/ 2916.50.95	2916.13.59	
108	SILVA LEDESMA TERRA, JULIO CESAR	Rincón y 25 de Mayo, Ed.Rafael apto. 902, Maldonado				
109	PLA REGULES, MARIA MARTA	Cerrito 420 esc. 404	11000	2915.66.20		
110	AMOZA ANTUNEZ DE OLIVERA, EDGARDO	Juncal 1305 piso 2 esc. 206	11000	2916.43.66		
111	MINICELLI D'AMATO, NELSON DANIEL	Alfredo Baldomir 2363 apto.202	11300	-		
112	GUTIERREZ GALIANA, JORGE	Río Branco 1359 apto.903	11000	2901.78.34		
113	MOREIRA BIRRIEL, MARIA GRACIELA	Río Branco 1359 apto.903	11100	2901.78.34		
114	GENTA FONS, PABLO	Cnel. Brandzen 1961 of. 1004	11200	2409.24.21/ 2402.79.39	2408.77.26	gentafons@fastlink.com.uy
115	CARNELLI DI LEONE, CARLOS RAFAEL	Coronel Alegre 1321 piso 4	11300	2709.94.29		
116	IRIBARNE AGUINSKY, NORA	Bulevar España 2166 apto.302	11300	-		
117	GARCIA VILA, MARIO DANIEL	Maggiolo 685	11300	2711.57.41		
118	MARTINEZ VIVAS, MARIA INES	Reconquista 517 piso 6	11000	2917.01.87	2916.34.05	minesm@adinet.com.uy
119	GIAMBRUNO MAROÑO, MARIA INES	25 de Mayo 467 piso 5	11000	2916.19.13	2916.57.40	mgiambruno@fernandezsecco.com

Nro	Nombre	Dirección	CP	Teléfono	Fax	E-mail
120	PONZONI GARCIA, JOSE LUIS	Juncal 1431 esc.702	11000	2915.82.11		
121	GUADALUPE BRENNNA, DIEGO	Ellauri 896 apto.101	11300	-		
122	VENCE CASSINA, TERESITA ANDREA	Hernandarias 3623	11400	2507.77.64		
123	CASTELLS BARTHABURU, MARÍA DE LAS MERCEDES	San José 807 esc. 403	11100	2908.71.67	2908.35.58	fischer@fischer.com.uy
124	CHARLONE SPINNELLI, BENJAMIN DANIEL	Brandzen 1961 esc.502	11200	-		
125	IGLESIAS HERRERO, LUIS FERNANDO	Zabala 1394 bis piso 1	11000			luisf.iglesias@gmail.com
126	ARIAS DURAN, JORGE ALFREDO	Ituzaingó 1312 apto.205	11000	2915.91.41/ 2915.89.08	2916.42.56	ariasjalf@yahoo.com
127	STIGLITZ HOLZMAN, BERNARDO MENDEL	18 de julio 1516 apto.2		-		
128	DURAN RAMALLO, JORGE HORACIO	San José 871	11100	-		
129	STEZANO MARIÑO, ANA MARIA	Convención 1307 Of.502	11100	2902.21.98	2902. 66.53/ 095314299	anamaria@stezano.com
130	GUICHON SILVA, JOSE LUIS	Pza.Cagancha 1335 esc. 206	11100	2902.31.18/ 2902.16.55	2902.13.44	jones@jones.com.uy
131	STUCZYNSKI SLONIMSKY, GERARDO DAVID	Charrúa 2665		-		
132	ESPALTER MASOLLER, HAROLDO JOSE	Dr. Elazarola 2319	11400	2600.02.07		
133	HUGHES PORRAS, MARIA MARIELA	25 de mayo 455 piso 4	11000	2915.56.83		
134	RISSO SHIEN, LAURA LUCIA	Río Negro 1354 apto.14	11100			
135	BACOT SILVEIRA, MONICA SUSANA	Av. 18 de Julio 841, piso 4 / 402		2903.20.47/ 2900.41.02	2903.21.03	monicabacot@mbs.com.uy
136	DEL CERRO ROLDOS, SUSANA VERÓNICA	Echevarriarza 3535 Of. 1601 Torre A	11300	2623.29.59	2623.29.57	sdelcerro@pittaluga.com
138	RODRIGUEZ VILLAMIL RIVIERE, RAMIRO	Máximo Tajés 6482	11400	2600.59.81		

Nro	Nombre	Dirección	CP	Teléfono	Fax	E-mail
140	LAPENNE IMAZ, EDUARDO MARCELO	Pedro Murillo 6136	11500	2604.03.60	2604.66.69	fox@fox.com.uy
141	TERRA ORTIZ DE TARANCO, ANA INÉS	Plaza Independencia 831 Of. 507	11000	2908.86.38	2908.86.40	bacot@bacot.com.uy
142	LARREA CASTRO, MAGELA ADRIANA	J.C.Gomez 1479	11100	2915.99.48		
143	SANTUCCI SCARLATO, ANA MARIA	Araucana 1312	11400	2600.21.03		
144	VANRELL FALCON, JUAN EDUARDO	Prof. J. C. Sabat Pebet 1230 Of. 508	11300	2628.60.33	2622.53.55	juanvanrell@vanrell.com.uy
145	LOPEZ OTTE, MARIO ANDRES	Araucana 1277	11400	2606.06.06	2606.14.39	cikato@cikato.com.uy
146	CAMPOS BARNECH, ENRIQUE FERNANDO	Paraguay 1196 esc. 002	11200	2901.46.44	2901.46.44	camposbarnech@hotmail.com
147	SCHULKIN GURMAN, AUGUSTO FERNANDO	Bulevar España 2293	11200	2401.09.94		
148	GARCIA GONZALEZ, SYLVIA ESTELA	Pablo Podestá 1293		-		
149	FERNANDEZ IRUJO, MARIA BEATRIZ	Pablo Pérez 4523		2215.11.32		
150	BAZZI GALLI, CARINNA GLORIA	Mercedes 1787		2400.91.36	2408.57.21	cbazzi@ertec.com.uy
151	GONZALEZ PITA, MARCELO JOSE	Pagola 3261 apto.104	11300	2709.25.65		
152	GIAMBRUNO MAROÑO, GABRIEL GERARDO	25 de Mayo 467 of. 401	11000	2916.19.13 AL 15	2916.57.40	fersecco@adinet.com.uy
153	TONARELLI DE PENA, MARIA NOEL	25 de mayo 587 apto.101	11000	2916.54.92		
154	SCIARRA CAUBARRERE, ALEJANDRO	Rincón 531, Oficina 202		2916.66.45		sciarra@sciarra.com.uy
155	SCIARRA CAUBARRERE, ADRIANA	Lido 1621	11400	2604.38.59		
156	TEUTEN BROOKER, MARK CHRISTOPHER	WTC Torre III, Luis A. De Herrera 1248 Piso 15	11000	2908.86.38	2908.86.40	mteuten@cmlawyers.com.uy
157	ALVAREZ PERSICO, CARLOS	Pza. Cagancha 1335 esc. 206	11100	2902.31.18/ 2902.16.55	2902.13.44	jones@jones.com.uy
158	SUR BRAND, JORGE	Rambla República del Perú 851 ap.301	11300	2710.84.92		

Nro	Nombre	Dirección	CP	Teléfono	Fax	E-mail
159	ETCHEVERRY REYES, AGUSTIN	Cerrito 507 piso 5	11000	-		
160	SALAVERRY GALBARINI, LUCIA	Juan Carlos Gomez 1479 Esc 309	11000	2914.63.68	099611553	luciasalaverry@yahoo.com
161	STERENSTEIN PESQUERA, FERNANDO	Aurora 362		2309.35.86		
162	PEREYRA LETTIER, ROBERTO ELBIO	Vicente Yañez Pinzón 4743		2308.25.09		
163	LARMINY LOPEZ, EDGARDO	Juan Proudfoot 1764	12400	2321.18.57		elarminy@vera.com.uy
164	PEREIRA SARALEGUI, TORIBIO AMALIO	Rincón 528 piso 6	11000	2916.50.94/95	2916.13.59	tpereira@barbosa.com.uy
165	MORGADE DI POLITO, NORA	Rincón 528 piso 6	11000	2916.50.94/95	2916.13.59	barbosa@barbosa.com.uy
166	PASTORINO LEPRA, CARLOS AMERICO	Feliciano Rodríguez 2709	11300	2709.04.12		
167	GALANTE ALVAREZ, DIEGO	Bulevar Artigas 1154	11300	2708.71.72	2708.71.72	info@galantemartins.com
168	CASULO BERNASCONI, EDISON HUMBERTO	José María Montero 2770	11308	099.612341	099.612341	info@legaluy.com
169	DETJEN ETCHEVERRIGARAY, XIMENA MARIA	Colonia 1561 apto. 201		2400.32.97		
170	BERRETA NOBOA, ALVARO RAFAEL	Av. Rivera 6606	11500	2600.82.41		
171	MARTINEZ GARCIA, MARIA CECILIA	J. Zavala Muniz 5556		2601.84.78	2601.84.78	reherma@adinet.com.uy
172	DE FREITAS STRAUMANN, EDUARDO	Andes 1418 apto. 201	11100	29011191/ 2902.53.03		
173	ELUTCHANZ GRAZIANO, NATALI CRISTINA	Maldonado 1378 apto.501		-		
174	CHALKLING MAJO, ANA CAROLINA	Luis B. Cavia 3071 Of. 904	11300	2708.40.13	2708.40.13	cchalkling@estudiochalkling.com
175	RUIZ ABOU-NIGM, VERONICA	Juncal 1327 esc. 2001	11000	2915.50.01	2915.43.75	marcas@ppv.com.uy
176	NOCETTI HERRERA, ANA AMELIA	Juncal 1392	11300	2900.10.00	2623.29.57	anocetti@ferrere.com
177	DEFFEMINIS PAIVA, JUAN BAUTISTA	Mones Roses 6937	11500	2604.16.04	2604.66.04	jdeffeminis@ppv.com.uy
178	LUSSICH, ALICIA	Yamandú Rodríguez 79 (Parque de Miramar) Canelones				

Nro	Nombre	Dirección	CP	Teléfono	Fax	E-mail
179	LARROSA DE BRUN, GUSTAVO	Calle Indiana s/n, M30 S2 (Médanos de Solymar) Canelones		098.03.91.70		gustavo@larrosaip.com.uy
180	CIKATO ABENTE, ANDRES	Araucana 1277	11400	2606.06.06	2606.14.39	cikato@cikato.com.uy
181	PITTALUGA PEREIRA, JUAN MARTIN	Echevarriarza 3535 Of. 1601 Torre A	11300	2623.29.59	2623.29.57	martin@pittaluga.com
182	BAZZANO OEHLER, VERONICA MARIA	Buenos Aires 618 piso 3	11100	2917.03.60	2916.09.92	fox@fox.com.uy
183	BUGALLO MONTAÑO, NYDIA BEATRIZ	Jaime Zudañez 2628 apto. 101	11300	2710.75.66		
184	ZERBINO STAJANO, RAFAEL AUGUSTO	Treinta y Tres 1271	11000	2916.03.10	2915.56.69	rzerbino@bkzr.com
185	CREMONESE MORETTO, CARMEN RAQUEL	Misiones 1475 esc. 202	11100	-		
186	CEA BACOT, MARÍA FERNANDA	Costa Rica 2003	11500	094.26.55.62		mceabacot@gmail.com
187	CESTAU FERNÁNDEZ, GRACIELA JOSEFINA	Pedro Murillo 6136	11500	2604.03.60		gcestau@fox.com.uy
188	ALZUGARAY GONZALEZ, ALICIA GOYA	Av. Pedro Blanes Viale 5919		2606.15.38		estudio@aya.com.uy
189	SARLABÓS BUZÓ, CARLOS EDUARDO	Brandzen 1961 Of. 205	11200	094383200 092073674		info@mercomark.com.uy
190	BARREIRO RIUS, MARÍA JACQUELINE	Misiones 1371 Esc. 31	11100	2915.17.34	2916.27.55	jbarreiro@lvm.com.uy
191	ESTEVEZ GOMEZ, HUGO WASHINGTON	WTC Torre III, Luis A. De Herrera 1248 Piso 15	11300	2622.99.90		hesteves@cmlawyers.com.uy
192	DUFRECHU RODRIGUEZ, DIEGO	Plaza Cagancha 1335 Of. 206	11100	2902.31.18/ 2902.16.55	2902.13.44	DDufrechu@jones.com.uy
193	SILVA ELIZALDE, ANA VICTORIA	Av. 18 de Julio 856 piso 5		2902.31.35		
194	FOX PEREYRA, VICTORIA HELENA	Pedro Murillo 6136	11500	2604.03.60	2604.66.69	vfox@fox.com.uy
195	BENTANCOR BENTANCOR, MARÍA CECILIA	Tomás Gomensoro 2984		2481.98.41	2481.98.41	cbentan@hotmail.com
196	FERNANDEZ BALLESTEROS, CARLOS ALBERTO	Piedras 509		2915.05.76		info@osfb.com.uy

Nro	Nombre	Dirección	CP	Teléfono	Fax	E-mail
197	SALGADO CARDOZO, VIVIAN DANIELA	Ramos 4234				
198	ROMANG COLOMINAS, CATHERINE	Misiones 1424 piso 2		2916.58.59	2916.58.63	cromang@olivera.com.uy
199	CHALAR SANZ, LAURA LUCIA	Misiones 1424 piso 2		2916.58.59	2916.58.63	lchalar@olidelp.com
200	STEINER DONNANGELO, ALMA	Colonia 810 esc. 703	11100	2900.97.30	2900.97.30	asteiner@als-abogados.com.uy
201	CIKATO ABENTE, MATIAS	Araucana 1277	11400	2606.06.06	2606.14.39	cikato@cikato.com.uy
202	PALADINO TURRA, NATALIA	WTC Torre III, Luis A. De Herrera 1248 Piso 15	11300	2622.99.90		npaladino@cmlawyers.com.uy
203	MATEOS TUCUNA, FABIANA	Prof. J. C. Sabat Pebet 1230 Of. 508	11300	2628.60.33	2622.53.55	fabianamateos@vanrell.com.uy
204	VANRELL FALCÓN, VERÓNICA LOURDES	Prof. J. C. Sabat Pebet 1230 Of. 508	11300	2628.60.33	2622.53.55	veronicavanrell@vanrell.com.uy
205	MAYER WEST, AGUSTÍN	Juncal 1392	11000	2900.10.00		amayer@ferrere.com
206	MATTSSON MOELLER, SIGRID ANNITA					mattrod@adinet.com.uy
207	FERNANDEZ REQUENA, ISABEL	25 de Mayo 467 piso 5	11000	2916.19.13	2916.57.40	ifernandez@fernandezsecco.com
208	PEREIRA, LEONARDO APARICIO	Arturo Santana 811, Esc. 002, Maldonado		4223.53.44 4224.43.57	4224.88.97	lapestudio@gmail.com
209	VALLEJO ESPÍÑEIRA, CECILIA MARIA	Andes 1293 esc. 501		2292.28.69		cvallejo@ciappesoni.com
210	LAPENNE DE SALTERAIN, MARCOS	Pedro Murillo 6136	11500	2604.03.60	2604.66.69	mlapenne@fox.com.uy
211	LAPENNE DE SALTERAIN, JUAN	Pedro Murillo 6136	11500	2604.03.60	2604.66.69	jlapenne@fox.com.uy
212	CERVIERI GHIOLDI, VIRGINIA	WTC Torre III, Luis A. De Herrera 1248 Piso 15	11300	2622.99.90		cervierimonsuarez@cmlawyers.com.uy
213	FERNÁNDEZ GIAMBRUNO, AGUSTINA MARÍA	25 de Mayo 467 piso 5	11000	2916.19.13	2916.57.40	afernandez@fernandezsecco.com
214	ACHARD SANCHEZ, JORGE LUIS	WTC Torre III, Luis A. De Herrera 1248 Piso 15				
215	ACOSTA PÉREZ, MARTÍN SEBASTIÁN	Soriano 895 Ap. 304				
216	PENADÉS GRAJALES, FABIANA	Juncal 1355 of. 1101	11000	2916.65.68	2915.36.44	fpenades@clarkemodet.com.uy

Nro	Nombre	Dirección	CP	Teléfono	Fax	E-mail
	VERÓNICA					
217	BENITEZ ALVEZ, CARLOS EDGARDO	Prof. J. C. Sabat Pebet 1230 Of. 508	11300	2628.60.33	2622.53.55	carlosbenitez@vanrell.com.uy
218	WENG POLICICCHIO, STELLA MARINA	Juncal 1392	11000	2900.10.00		sweng@ferrere.com
219	CAMACHO CABRERA, MARITZA	Emilio Frugoni 886 apto. 401		24119600		aycmarcas@gmail.com
220	GALLO DUBOURG, ANDRÉS	Roque Graseras 661	11300	2716.77.69		info@mdubourg.com
221	ALTERWAIN BRUCK, ALEJANDRO	Juncal 1392	11000	2900.10.00		aalterwain@ferrere.com
222	ANTÚNEZ SEVESO, MÓNICA ANDREA	Avda. Giannatasio M10 S4, Local 7, Shangrilá, Ciudad de la Costa, Canelones				
223	ARAÚJO PERDOMO, XIMENA	Obligado 1208/102				
224	GOMENSORO VIDAL, NATALIA	Rincón 528 piso 6	11000	2916.50.94/95	2916.13.59	ngomensoro@barbosa.com.uy
225	IDOYAGA BARRO, ADOLFO MARIO	José Ellauri 7090/401				
226	GARIN da SILVA, DENIS FABIAN	Avenida Capitán Leal 5409				
227	BEZÓN RODRIGUEZ, STELLA MARIS	Durán 2131 ap. 104				
228	LANZON SEGOVIA, RAFAEL	Brandzen 1961, Piso 1 Esc.102	11200	2408.50.38	2409.97.61	rafael@lanzon.com.uy
229	AMORÍN DEL CAMPO, BERNARDO JULIO					bamorin@amorinabogados.com
230	FISCHER CASTELLS, FEDERICO GUILLERMO	Liorna 6550				
231	FOX PEREYRA, MARIANA	Murillo 6136				mfox@fox.com.uy
232	PITTALUGA ROSSI, GABRIEL MARÍA	Echevarriarza 3535, esc. 1601				gabrielpittaluga1@gmail.com
233	MARY PATRICIA CHAVES TELIZ					dra.patriciachavesteliz@gmail.com
234	MANUELA CABRERA SALVO	Juan Paullier 1236				manuela.cabrera82@gmail.com
235	JONAS KING BERGSTEIN KLECKIN	Av. 18 de Julio 1117 Piso 5°				svila@bergsteinlaw.com
236	KAREN NAHIR FERNÁNDEZ SUÁREZ	Ituzaingo1312/201				Karenfernandezsuarez@gmail.com
237	JUAN JOSÉ CURONE SÁNCHEZ	Rio Branco 1481				juanjocurone@hotmail.com
238	ANA PAULA BIANCHIMANO LOPEZ	Buenos Aires 397 Esc. 601		29152804		

Nro	Nombre	Dirección	CP	Teléfono	Fax	E-mail
239	VILLAMIL RODRÍGUEZ, PABLO	Av. General Flores 2282 unidad 105	11800	2209.61.29 091.096.947		
240	PRIORE GONZALEZ , MARIA BELEN	Avenida Rivera 5511	11400	099.860.427		mbpriore@gmail.com
241	MARCELO FEMENIAS	Treinta y Tres 1271	11200			mfemenias@bkzr.com.uy
242	FLORENCIA TORRESANI	Indiana M30 S2 (Médanos de Solymar, Canelones)	11600			uruguay@balderip.com
243	ANDREA KARINA CALCATERRA	Carlos Puig 1514 (Dolores-Soriano)				
244	FELIPE MARTINEZ ARDOINO	Asturias 1496	11400			felipe@martinezleoni.com.uy
245	JUANA BACOT	25 de Mayo	11000			jbacot@bacot.com.uy
246	CARMELA BACOT KONKE	Echevarriarza 3406				cbacot@bacot.com.uy
247	ESTEBAN NICOLAS CABALLERO MADERA	Plaza Cagancha 1335 Of .206		29023118		ncaballero@jones.com.uy
248	MANUEL GRAÑA GIANONI	Jose Marti 3263 Apto 301		099043466		manuelg90@gmail.com
249	RUBEN GABRIEL MENDEZ IRIGOYEN	Héctor Barrios esq. Circunvalación s/n°				gabrielmendez272@gmail.com

Advertencia.

“Es responsabilidad de los Sres. Agentes mantener actualizada la información precedente para su publicación en este Boletín, pudiendo solicitar los cambios que correspondan por correo electrónico dirigido a, Secretaria.DNPI@miem.gub.uy “

Todo usuario que haya presentado o presente una solicitud de registro mediante el Sistema de Presentación en Línea de la DNPI, deberá ingresar al mismo vía web para realizar el seguimiento de su solicitud, revisar los avisos de notificaciones pendientes, y proceder a notificarse. En caso de no seguir el procedimiento de notificación en línea en un plazo de 3 días hábiles, se tendrá por efectuada sin necesidad de constancia alguna comenzando a correr los plazos legales

SOLICITUDES DE MARCAS

El procedimiento utilizado no permite en todos los casos reproducir con exactitud los distintos matices de los colores.

Para oír los audios de las Marcas Sonoras que se publiquen en el presente Boletín debe ingresar por el siguiente link

<https://www.gub.uy/ministerio-industria-energia-mineria/comunicacion/publicaciones/repositorio-marcas-sonoras>

(210) **519686** (540)
(730) **ASOCIACION TURISTICA DE
MONTEVIDEO; UY**
(220) 08/12/2020
(511) **36 (S/D)**
(740) 21 de Setiembre 3133, Montevideo, 11300,
Montevideo, Montevideo, UY

MONTEVIDEO PASS

(210) **524409** (540)
(730) **Carolina Hernandez; UY**
(220) 21/05/2021
(511) **41 (S/D) y 45 (S/D)**
(740) Eufemio Masculino 2541/603, Montevideo,
11300, Montevideo, Montevideo, UY

TAROT AKASHICO URUGUAY

(210) **540037** (540)
(730) **TRANSPORTE SELLANES SRL; UY**
(220) 14/07/2022
(511) **39 (S/D)**
(740) Avenida Libertad 1476 apto 203, Montevideo,
, Montevideo, Montevideo, UY

(591) Rojo y azul



(210) **540697**
(730) **Target Brands, Inc.**; US
(220) 01/08/2022
(511) **35 (S/D) y 36 (S/D)**
(740) 194

(540)



(210) **540802**
(730) **VARELA HERMANOS, S.A.**; PA
(220) 03/08/2022
(511) **33 (S/D)**
(740) 212

(540)

(591) 7402 4975 4725 871 492 491.



(210) **540882**
(730) **ALIAN S.A.**; UY
(220) 05/08/2022
(511) **35, 36, 41, 43 y 44**
(740) 144

(540)

(591) Ver Adjunto



(210) **540883** (540)
(730) **ALIAN S.A.**; UY
(220) 05/08/2022
(511) **35, 36, 41, 43 y 44**
(740) 144

(591) Ver Adjunto



(210) **540964** (540)
(730) **Rootstrap Holdings, Inc.**; US
(220) 08/08/2022
(511) **42 (S/D)**
(740) 94

ROOTSTRAP

(210) **540965** (540)
(730) **Rootstrap Holdings, Inc.**; US
(220) 08/08/2022
(511) **42 (S/D)**
(740) 94

(591) No reivindica colores



(210) **540985** (540)

(730) **Pablo Malian**; UY

(220) 08/08/2022

(511) **1 (S/D)**

(740) Magariño Cervantes 1664, Montevideo, ,
Montevideo, Montevideo, UY

(591) Cyan



(210) **541039** (540)

(730) **Prestadores de Servicios de Colima, S.A de**
C.V.; MX

(220) 09/08/2022

(511) **29 (S/D)**

(740) 144

(591) Rojo y blanco



(210) **541040** (540)

(730) **Prestadores de Servicios de Colima, S.A de**
C.V.; MX

(220) 09/08/2022

(511) **29 (S/D)**

(740) 144

(591) azul, celeste, verde violeta y blanco



(210) **541041** (540)
(730) **Prestadores de Servicios de Colima, S.A de**
C.V.; MX
(220) 09/08/2022
(511) **29 (S/D)**
(740) 144



(210) **541042** (540)
(730) **Prestadores de Servicios de Colima, S.A de**
C.V.; MX
(220) 09/08/2022
(511) **29 (S/D)**
(740) 144



(210) **541043** (540)
(730) **Prestadores de Servicios de Colima, S.A de**
C.V.; MX
(220) 09/08/2022
(511) **35 (S/D)**
(740) 144

(591) celeste, blanco y negro



(210) **541081** (540)
(730) **EVC INDUSTRIAL LTDA; BR**
(220) 10/08/2022
(511) **3 (S/D)**
(740) 144

VONIXX

(210) **541084** (540)
(730) **ESTEVE PHARMACEUTICALS, S. A.;**
ES
(220) 10/08/2022
(511) **5 (S/D)**
(740) 144

VELYNTRA

(210) **541085** (540)
(730) **ESTEVE PHARMACEUTICALS, S. A.;**
ES
(220) 10/08/2022
(511) **5 (S/D)**
(740) 144

SEGLENTIS

(210) **541179** (540)
(730) **INTENDENCIA DE MONTEVIDEO; UY**
(220) 12/08/2022
(511) **38**
(740) 212

(591) Verde, blanco



(210) **541180** (540)
(730) **INTENDENCIA DE MONTEVIDEO; UY**
(220) 12/08/2022
(511) **41**
(740) 212

(591) Verde, blanco



(210) **541256** (540)
(730) **Versalis S.p.A.; IT**
(220) 12/08/2022
(511) **1 (S/D) y 17 (S/D)**
(740) 212
(300) 302022000030944 28/02/2022 IT

AGON

(210) **541258** (540)
(730) **Versalis S.p.A.**; IT
(220) 12/08/2022
(511) **1 (S/D) y 17 (S/D)**
(740) 212
(300) 302022000030959 28/02/2022 IT
(591) GRIS Y ROJO



(210) **541298** (540)
(730) **AGAM LTDA.**; UY
(220) 15/08/2022
(511) **3 y 5**
(740) 165

VARI-RELAX

(210) **541364** (540)
(730) **CAROLINA PEREZ OSPITAL**; UY
(220) 16/08/2022
(511) **35**
(740) GOES 2337, MONTEVIDEO, ,
MONTEVIDEO, MONTEVIDEO, UY

(591) GRIS- NEGRO



(210) **541368** (540)
(730) **Luveck Medical Corp.**; VG
(220) 16/08/2022
(511) **5 (S/D) y 10 (S/D)**
(740) 144

(591) Pantone 1505, Pantone Reflex Blue



(210) **541374** (540)
(730) **Novus Importaciones SRL**; UY
(220) 16/08/2022
(511) **11**
(740) Constituyente 1765, Montevideo, ,
Montevideo, Montevideo, UY



(210) **541389** (540)
(730) **SOMOS FLORA SAS**; UY
(220) 16/08/2022
(511) **43**
(740) 245

(591) -



(210) **541416**
(730) **Lemontech SpA**; CL
(220) 17/08/2022
(511) **42 (S/D)**
(740) 144

(540)

TIMEBILLING

(210) **541417**
(730) **Lemontech SpA**; CL
(220) 17/08/2022
(511) **42 (S/D)**
(740) 144

(540)

CASETRACKING

(210) **541492**
(730) **APLAZ S.A DE C.V.**; MX
(220) 19/08/2022
(511) **36**
(740) 144

(540)

APLAZO

(210) **541495** (540)
(730) **INTRASOFTWARE S.R.L.**; UY
(220) 19/08/2022
(511) **38, 39 y 42**
(740) 144

(591) 0052F6



(210) **541506** (540)
(730) **Augmented Reality Concepts, Inc.**; US
(220) 19/08/2022
(511) **9 (S/D) y 42 (S/D)**
(740) 218
(300) 97277863 22/02/2022 US y 97277870
22/02/2022 US

**EXCEPTIONALLY ENGAGING
EXPERIENCES**

(210) **541512** (540)
(730) **VEROPE AG**; CH
(220) 19/08/2022
(511) **6 (S/D) y 42 (S/D)**
(740) 245

VEROPE MINING

(210) **541520** (540)
(730) **IXALAB S.A.S.**; UY
(220) 19/08/2022
(511) **9, 35, 36, 38, 39 y 42**
(740) 228

(591) Anaranjado

● TraceSurfer

(210) **541542** (540)
(730) **LOUIS DREYFUS TRADEMARKS B.V.**;
NL
(220) 22/08/2022
(511) **5 (S/D), 9 (S/D) y 44 (S/D)**
(740) 144

LOUIS DREYFUS

(210) **541543** (540)
(730) **LOUIS DREYFUS TRADEMARKS B.V.**;
NL
(220) 22/08/2022
(511) **5 (S/D), 9 (S/D) y 44 (S/D)**
(740) 144

LDC.
Louis Dreyfus Company

(210) **541583** (540)
(730) **LABOCAY S.R.L.**; AR
(220) 22/08/2022
(511) **3 (S/D)**
(740) 212

ITSANI PLASMA MARINO

(210) **541585** (540)
(730) **Tri-Union Seafoods, LLC**; US
(220) 22/08/2022
(511) **29 (S/D)**
(740) 212



(210) **541684** (540)
(730) **SUZANO S.A.**; BR
(220) 24/08/2022
(511) **16 (S/D)**
(740) 34

(591) 0

LIN
suzano

(210) **541685** (540)
(730) **SUZANO S.A.**; BR
(220) 24/08/2022
(511) **16 (S/D)**
(740) 34

(591) 0



(210) **541716** (540)
(730) **Aviva Brands Limited**; GB
(220) 26/08/2022
(511) **35 (S/D), 36 (S/D) y 41 (S/D)**
(740) 144
(300) UK00003823267 24/08/2022 GB

AVIVA INVESTORS

(210) **541721** (540)
(730) **SERRAT, ERNESTO**; AR
(220) 26/08/2022
(511) **16, 25 y 35**
(740) 144

(591) Celeste



(210) **541727** (540)
(730) **Miguel Gentile y Andrea Liotti**; UY
(220) 26/08/2022
(511) **35**
(740) 212

(591) verde blanco



(210) **541729** (540)
(730) **ZV Singapore Pte. Ltd.**; SG
(220) 26/08/2022
(511) **9 (S/D), 14 (S/D), 18 (S/D) y 25 (S/D)**
(740) 34

ZADIG & VOLTAIRE

(210) **541737** (540)
(730) **PEREZ PARONI, SANTIAGO y**
GONZALEZ MONTANER, MAGIN; AR
(220) 26/08/2022
(511) **25 (S/D)**
(740) 217



(210) **541741** (540)
(730) **SELINA LOYALTY MANAGEMENT LTD.; GB**
(220) 26/08/2022
(511) **35 (S/D)**
(740) 144

LUNA NUEVA

(210) **541743** (540)
(730) **EL HOGAR DE LAS MEDIAS S.A.; UY**
(220) 26/08/2022
(511) **25**
(740) 245

(591) ROSADO, GRIS, BEIGE, BLANCO Y
NEGRO TODOS EN DISTINTOS TONOS



(210) **541757** (540)
(730) **SILVA BARRUTI MARIA EUGENIA Y DE STEFANI MENDILAHRSU ANDRES JUAN SOCIEDAD DE HECHO; UY**
(220) 30/08/2022
(511) **25 y 35**
(740) 201

NOSELODIGAS

(210) **541758** (540)
(730) **SILVA BARRUTI MARIA EUGENIA Y
DE STEFANI MENDILAHRSU ANDRES
JUAN SOCIEDAD DE HECHO; UY**
(220) 30/08/2022
(511) **25 y 35**
(740) 201

The logo consists of the letters 'NSLd' in a bold, black, sans-serif font. The 'd' is lowercase and has a slightly rounded bottom.

(210) **541773** (540)
(730) **EQUIPO S.A.; UY**
(220) 30/08/2022
(511) **6**
(740) 144

(591) Pantone 314 C

The logo features the word 'Tem' in a stylized, blue, cursive font. The letters are connected and have a slight shadow effect.

(210) **541774** (540)
(730) **EQUIPO S.A.; UY**
(220) 30/08/2022
(511) **7**
(740) 144

(591) Pantone 314 C

The logo features the word 'Tem' in a stylized, blue, cursive font. The letters are connected and have a slight shadow effect.

(210) **541775**
(730) **EQUIPO S.A.**; UY
(220) 30/08/2022
(511) **8**
(740) 144

(540)

(591) Pantone 314 C



(210) **541776**
(730) **EQUIPO S.A.**; UY
(220) 30/08/2022
(511) **9**
(740) 144

(540)

(591) Pantone 314 C



(210) **541778**
(730) **EQUIPO S.A.**; UY
(220) 30/08/2022
(511) **11**
(740) 144

(540)

(591) Pantone 314 C



(210) **541781** (540)
(730) **EQUIPO S.A.**; UY
(220) 30/08/2022
(511) **20**
(740) 144

(591) Pantone 314 C



(210) **541782** (540)
(730) **EQUIPO S.A.**; UY
(220) 30/08/2022
(511) **21**
(740) 144

(591) Pantone 314 C



(210) **541783** (540)
(730) **EQUIPO S.A.**; UY
(220) 30/08/2022
(511) **35**
(740) 144

(591) Pantone 314 C



(210) **541784**
(730) **EQUIPO S.A.**; UY
(220) 30/08/2022
(511) **37**
(740) 144

(540)

(591) Pantone 314 C



(210) **541785**
(730) **EQUIPO S.A.**; UY
(220) 30/08/2022
(511) **39**
(740) 144

(540)

(591) Pantone 314 C



(210) **541799**
(730) **DELIBRA S.A.**; UY
(220) 30/08/2022
(511) **5 (S/D)**
(740) 245

(540)

EMPIRIA

(210) **541801** (540)
(730) **Walter Gabriel Chirico Chinelli**; UY
(220) 30/08/2022
(511) **41 (S/D)**
(740) 25 de mayo 555/504, Montevideo, ,
Montevideo, Montevideo, UY

(591) verde, blanco, beige, marrón y negro



(210) **541804** (540)
(730) **Hexagon Trading AG**; CH
(220) 30/08/2022
(511) **36 (S/D) y 39 (S/D)**
(740) 235

HEXAGON TRADING

(210) **541806** (540)
(730) **Hexagon Trading AG**; CH
(220) 30/08/2022
(511) **36 (S/D) y 39 (S/D)**
(740) 235

(591) Gris, celeste, azul



(210) **541807** (540)
(730) **Hexagon Group Ltd; CH**
(220) 30/08/2022
(511) **36 (S/D) y 39 (S/D)**
(740) 235

HEXAGON GROUP

(210) **541811** (540)
(730) **Hexagon Group Ltd; CH**
(220) 30/08/2022
(511) **36 (S/D) y 39 (S/D)**
(740) 235

(591) Gris, celeste, azul



(210) **541812** (540)
(730) **FEDERICO M. RODRÍGUEZ DOS
SANTOS S.A.S. SOCIEDAD POR
ACCIONES SIMPLIFICADA; UY**
(220) 30/08/2022
(511) **35**
(740) 34

(591) 0



(210) **541814** (540)
(730) **GENTILAR SAS; UY**
(220) 30/08/2022
(511) **36 (S/D)**
(740) 34

(591) PANTONE 402 C



(210) **541816** (540)
(730) **OLARTE FERNANDEZ JULIA LAURA;**
UY
(220) 30/08/2022
(511) **29**
(740) 212

*Cuatro
de Julia*

(210) **541819** (540)
(730) **OLARTE FERNANDEZ JULIA LAURA;**
UY
(220) 30/08/2022
(511) **32**
(740) 212

*Cuatro
de Julia*

(210) **541823** (540)
(730) **OLARTE FERNANDEZ JULIA LAURA;**
UY
(220) 30/08/2022
(511) **35**
(740) 212

*Cuatro
de Julia*

(210) **541826** (540)
(730) **OLARTE FERNANDEZ JULIA LAURA;**
UY
(220) 30/08/2022
(511) **43**
(740) 212

*Cuatro
de Julia*

(210) **541841** (540)
(730) **DIEGO GASTÓN GONZALEZ**
GONZALEZ; UY
(220) 30/08/2022
(511) **38 (S/D)**
(740) CONVENCION 1135, Montevideo, ,
Montevideo, Montevideo, UY

DIEGODELACURVA

(210) **541847** (540)

(730) **FRAU LANGDON, DIEGO
BARTOLOME**; UY

(220) 31/08/2022

(511) **35 y 39**

(740) 201

(591) VERDE, AZUL, BLANCO



(210) **541859** (540)

(730) **RODRIGUEZ LEHMANN, MARTIN**; AR

(220) 31/08/2022

(511) **33 (S/D)**

(740) 144



(210) **541865** (540)

(730) **INDISOR S.A.**; UY

(220) 31/08/2022

(511) **35 y 41**

(740) 189

BIG MUSIC

(210) **541869** (540)
(730) **CLAUDIA ADORNO SAS; UY**
(220) 31/08/2022
(511) **21, 27 y 35**
(740) 201

CLAUDIA ADORNO

(210) **541875** (540)
(730) **Joaquin Forrisi; UY**
(220) 31/08/2022
(511) **14**
(740) Julio Delgado 817, Salto, 50000, Salto, Salto,
UY

URUTHYST

(210) **541876** (540)
(730) **LEONARDO FRANCIA; UY**
(220) 31/08/2022
(511) **3 (S/D) y 25 (S/D)**
(740) Petrona Tuboras 228, DURAZNO, 97000,
DURAZNO, DURAZNO, UY

INKSIDE

(210) **541894** (540)
(730) **JUAN CARLOS LABARERE; AR**
(220) 31/08/2022
(511) **32**
(740) 144

SPORTADE

(210) **541897** (540)
(730) **Ace Rent A Car Reservations, Inc.; US**
(220) 31/08/2022
(511) **39 (S/D)**
(740) 144



(210) **541898** (540)
(730) **Ace Rent A Car Reservations, Inc.; US**
(220) 31/08/2022
(511) **39 (S/D)**
(740) 144

ACE RENT A CAR

(210) **541904** (540)
(730) **Walter Urruzola; UY**
(220) 31/08/2022
(511) **25 y 41**
(740) Antonio Machado 1917Apto 401,
Montevideo, 11810, Montevideo,
Montevideo, UY

(591) Rojo y blanco



(210) **541905** (540)
(730) **GREISING Y ELIZARZU SRL; UY**
(220) 31/08/2022
(511) **31 (S/D)**
(740) Libertad 1856, Tarariras, 70600, Colonia,
Colonia, UY

(591) Negro y Verde



(210) **541912** (540)
(730) **GARCIA LOPEZ NATALIA; UY**
(220) 31/08/2022
(511) **14, 18 y 25**
(740) 136

TIMBÓ

(210) **541923** (540)
(730) **PEÑAFLORES VIQUE ROMINA**; UY
(220) 31/08/2022
(511) **29, 30 y 41**
(740) 34

(591) 0



(210) **541924** (540)
(730) **ALCEC HERMANOS SRL**; UY
(220) 31/08/2022
(511) **3 (S/D), 21 (S/D) y 35 (S/D)**
(740) CONVENCIÓN 1135, Montevideo, 11700,
Montevideo, Montevideo, UY

EGAN

(210) **541926** (540)
(730) **Horacio Garagiola; Diego Martin Herrera
y Daniel Weiman**; AR
(220) 01/09/2022
(511) **35 y 37**
(740) Estados Unidos y La Plata, Punta Negra,
20200, Maldonado, Maldonado, UY

(591) Amarillo Azul Celeste



(210) **541927** (540)
(730) **Daramix S.A.**; UY
(220) 01/09/2022
(511) **35**
(740) 172

(591) Violeta, amarillo y blanco



(210) **541929** (540)
(730) **Ademar Firpo**; UY
(220) 01/09/2022
(511) **33**
(740) Charruas 767, Paysandu, 60000, Paysandú,
Paysandú, UY

LORENZO

(210) **541937** (540)
(730) **Horacio Miguel FRACCIONE**; AR
(220) 01/09/2022
(511) **38 y 41**
(740) 179

ACQUA

(210) **541938** (540)
(730) **Jorge Castillo**; UY
(220) 01/09/2022
(511) **35 (S/D)**
(740) Jaime Zudaez 2884, Montevideo, 11300,
Montevideo, Montevideo, UY

(591) celeste, amarillo



(210) **541945** (540)
(730) **Bausch & Lomb Incorporated**; US
(220) 01/09/2022
(511) **9 (S/D)**
(740) 212

BAUSCH + LOMB ULTRA

(210) **541950** (540)
(730) **MEGA LABS S.A.**; UY
(220) 01/09/2022
(511) **5**
(740) 144

MOSAPRINA

(210) **541951** (540)
(730) **RODRIGUEZ LEHMANN, MARTIN; AR**
(220) 01/09/2022
(511) **33 (S/D)**
(740) 144

DAMONJAG

(210) **541952** (540)
(730) **Clarios Technology and Recycling GmbH;**
DE
(220) 01/09/2022
(511) **9 (S/D)**
(740) 144



(210) **541954** (540)
(730) **LABORATORIO GADOR S.A.; UY**
(220) 01/09/2022
(511) **5**
(740) 165

MIRAGRON

(210) **541955** (540)
(730) **LABORATORIO GADOR S.A.;** UY
(220) 01/09/2022
(511) **5**
(740) 165

MYRGON

(210) **541956** (540)
(730) **LABORATORIO GADOR S.A.;** UY
(220) 01/09/2022
(511) **5**
(740) 165

MIRAFEL

(210) **541957** (540)
(730) **UCROPIT S.A.;** AR
(220) 01/09/2022
(511) **9 y 44**
(740) 212

(591) Amarillo, verde, azul, blanco

(210) **541960** (540)
(730) **INTERNATIONAL TAEKWON-DO
FEDERATION-ITF**; ES
(220) 01/09/2022
(511) **25 (S/D), 28 (S/D) y 41 (S/D)**
(740) 212
(300) 4160978 04/03/2022 ES
(591) Amarillo, verde, azul, rojo, negro



(210) **541961** (540)
(730) **SGG Lisco LLC**; US
(220) 01/09/2022
(511) **28 (S/D)**
(740) 245

NEVERFLAT

(210) **541962** (540)
(730) **ALU TRADE SRL**; AR
(220) 01/09/2022
(511) **21**
(740) 34

(591) 0

ALMA
Gourmet

(210) **541963** (540)
(730) **SGG Lisco LLC**; US
(220) 01/09/2022
(511) **28 (S/D)**
(740) 245

(591) -



(210) **541964** (540)
(730) **CACHAY S.A.**; AR
(220) 01/09/2022
(511) **30 (S/D)**
(740) 34

(591) PANTONE P 141-8C, PANTONE P 146-6C



(210) **541965** (540)
(730) **CACHAY S.A.**; AR
(220) 01/09/2022
(511) **30 (S/D)**
(740) 34

(591) PANTONE 159-C, PANTONE 8-9 C,
PANTONE 7528 C



(210) **541966**

(540)

(730) **CACHAY S.A.**; AR

(220) 01/09/2022

(511) **30 (S/D)**

(740) 34

(591) PANTONE 117 C, PANTONE 8-9 C,
PANTONE 7528 C



(210) **541967**

(540)

(730) **CACHAY S.A.**; AR

(220) 01/09/2022

(511) **30 (S/D)**

(740) 34

(591) PANTONE 3415 C, PANTONE 355 C,
PANTONE 8-9 C, PANTONE 7528 C



(210) **541968**

(540)

(730) **GIORGIO ARMANI S.P.A.**; IT

(220) 01/09/2022

(511) **3 (S/D)**

(740) 34

(591) negro, blanco, gris, beige, anaranjado



(210) **541969** (540)
(730) **VOKA SAS**; UY
(220) 01/09/2022
(511) **25 y 35**
(740) 194

(591) -



(210) **541970** (540)
(730) **Shaanxi Fast Gear Co., Ltd.**; CN
(220) 01/09/2022
(511) **12 (S/D)**
(740) 245

(591) -



(210) **541971** (540)
(730) **Strategic Reinsurance Consulting S.A.**; AR
(220) 01/09/2022
(511) **36**
(740) 34

(591) azul, blanco y verde



(210) **541972** (540)
(730) **PASTICHE SAS; UY**
(220) 01/09/2022
(511) **18, 25 y 35**
(740) 194

(591) -

PASTICHE

(210) **541973** (540)
(730) **PASTICHE SAS; UY**
(220) 01/09/2022
(511) **18, 25 y 35**
(740) 194

(591) -



(210) **541976** (540)
(730) **NUEVAVISION UY S.A.S; UY**
(220) 01/09/2022
(511) **35 y 44**
(740) 212

(591) Rojo, blanco

nuevavisión

(210) **541978** (540)
(730) **EUROPEAN COSMETICS LIMITADA;**
UY
(220) 01/09/2022
(511) **3**
(740) 168

(591) NEGRO - BLANCO - GRIS - ROJO -
ROSADO - NARANJA - VERDE -
MARRON - VIOLETA



(210) **541985** (540)
(730) **ALCEC HERMANOS SRL;** UY
(220) 01/09/2022
(511) **3 (S/D), 21 (S/D) y 35 (S/D)**
(740) CONVENCIÓN 1135, Montevideo, 11700,
Montevideo, Montevideo, UY

(591) #ceebf3 #04abc4 #3ac5d9 #0474c3 #4eb2db
#048fca #0494d4 #0484c4



(210) **541986** (540)
(730) **ALCEC HERMANOS SRL;** UY
(220) 01/09/2022
(511) **3 (S/D), 21 (S/D) y 35 (S/D)**
(740) CONVENCIÓN 1135, Montevideo, 11700,
Montevideo, Montevideo, UY

(591) #b0e6f9 #04acc3 #64e1f9 #05b9cb #586263
#59d2df #04acc #8c8c94



(210) **541987** (540)
(730) **Verisure Sàrl**; CH
(220) 02/09/2022
(511) **9 (S/D) y 45 (S/D)**
(740) 179
(300) EU 018666461 04/03/2022 EM

PRESENSE

(210) **541990** (540)
(730) **Blackstone TM L.L.C.**; US
(220) 02/09/2022
(511) **36**
(740) 194

BLACKSTONE

(210) **541991** (540)
(730) **Jose Francisco Arriada cedrez**; UY
(220) 02/09/2022
(511) **43 (S/D)**
(740) Miguel grau 3939.004, Buceo, 11300,
Montevideo, Montevideo, UY

PIZZA VA!

(210) **542001** (540)
(730) **IPSEN PHARMA S.A.S.**; FR
(220) 02/09/2022
(511) **5 (S/D) y 10 (S/D)**
(740) 192
(300) 4850850 09/03/2022 FR

SETSOMA

(210) **542002** (540)
(730) **IPSEN PHARMA S.A.S.**; FR
(220) 02/09/2022
(511) **5 (S/D) y 10 (S/D)**
(740) 192
(300) 4850835 09/03/2022 FR

EVOSOM

(210) **542013** (540)
(730) **CASA PIRQUE S.A.**; AR
(220) 02/09/2022
(511) **33 (S/D)**
(740) 94

ANACUARA

(210) **542014**
(730) **CASA PIRQUE S.A.**; AR
(220) 02/09/2022
(511) **33 (S/D)**
(740) 94

(540)

NAVIERO

(210) **542015**
(730) **BORED OXENS S.A.**; AR
(220) 02/09/2022
(511) **41**
(740) 234

(540)



(210) **542016**
(730) **Mat Product & Technology, S.L.**; ES
(220) 02/09/2022
(511) **9 (S/D)**
(740) 144

(540)

(591) Verde lima; gris plateado



(210) **542017** (540)
(730) **Jiangsu Tellus Power Co., Ltd.**; CN
(220) 02/09/2022
(511) **9 (S/D)**
(740) 144

TELLUSpo'weR

(210) **542018** (540)
(730) **Sol María Preube**; UY
(220) 02/09/2022
(511) **43**
(740) 144

(591) Pantone BLACK, Pantone 17-1363 TSX

FRANCA



(210) **542019** (540)
(730) **DELIDIPS SAS**; AR
(220) 02/09/2022
(511) **29**
(740) 144

(591) Anaranjado y Blanco

KYROS

(210) **542022** (540)
(730) **PTC Therapeutics International Limited;**
IE
(220) 02/09/2022
(511) **5 (S/D)**
(740) 201

TEGSEDI

(210) **542023** (540)
(730) **ARMET S.A.;** UY
(220) 02/09/2022
(511) **41 y 42**
(740) 201

(591) NEGRO, AMARILLO, VERDE, CELESTE,
ROSADO, BLANCO



(210) **542024** (540)
(730) **Reamerica Reinsurance Managers**
corredor de reaseguros S.A.; AR
(220) 02/09/2022
(511) **36 (S/D)**
(740) 94

(591) Rojo, negro



(210) **542028** (540)
(730) **Isaura S.A.**; AR
(220) 02/09/2022
(511) **1, 2 y 4**
(740) 245

(591) -



(210) **542033** (540)
(730) **LINEAGE LOGISTICS HOLDINGS,**
LLC.; US
(220) 02/09/2022
(511) **9 (S/D) y 42 (S/D)**
(740) 240
(300) 97/294140 03/03/2022 US

LINOS

(210) **542037** (540)
(730) **LABORATORIOS FERRINI S.A.I.C.I.**; AR
(220) 02/09/2022
(511) **3 (S/D)**
(740) 34

ZONO

(210) **542039** (540)
(730) **JIMENA MAZZONE ARTAGAVEYTIA;**
UY
(220) 02/09/2022
(511) **41**
(740) 194

(591) -

caminito

(210) **542042** (540)
(730) **LUMINOVA PHARMA CORPORATION**
GmbH; CH
(220) 02/09/2022
(511) **5 (S/D)**
(740) 212

(591) violeta



(210) **542043** (540)
(730) **LUMINOVA PHARMA CORPORATION**
GmbH; CH
(220) 02/09/2022
(511) **5 (S/D)**
(740) 212

UNIFEMME

(210) **542047** (540)
(730) **Instituto Pasteur de Cosmiatria Ltda.**; BR
(220) 02/09/2022
(511) **3**
(740) 163

(591) No reivindica colores



(210) **542049** (540)
(730) **Shaida Massud**; UY
(220) 05/09/2022
(511) **36 (S/D)**
(740) Martí 3245 apto 401, montevideo, ,
montevideo, montevideo, UY

HOUSING NEGOCIOS INMOBILIARIOS

(210) **542053** (540)
(730) **HRU S.A.**; UY
(220) 05/09/2022
(511) **9, 28, 31, 35, 36, 41, 43 y 44**
(740) 144

(591) Ver Adjunto

The logo features the word 'MAROÑAS' in a bold, sans-serif font. A yellow circle is positioned over the letter 'O', partially overlapping it.

(210) **542054** (540)
(730) **María Belén Rocha Dive**; UY
(220) 05/09/2022
(511) **21 (S/D)**
(740) Juan Benito Blanco 1106, Montevideo,
11300, Montevideo, Montevideo, UY

KITCHEN SPONGE

(210) **542055** (540)
(730) **María Belén Rocha Dive**; UY
(220) 05/09/2022
(511) **3 (S/D)**
(740) Juan Benito Blanco 1106, Montevideo,
11300, Montevideo, Montevideo, UY

FREECO

(210) **542059** (540)
(730) **General Motors LLC**; US
(220) 05/09/2022
(511) **12 (S/D)**
(740) 136

MULTIBOARD

(210) **542062** (540)

(730) **PREMEZCLAS ENERGETICAS
PECUARIAS S.A. DE C.V.; MX**

(220) 05/09/2022

(511) **5 (S/D) y 31 (S/D)**

(740) 34

(591) AZUL, ANARANJADO



(210) **542071** (540)

(730) **LEVI STRAUSS & CO.; US**

(220) 05/09/2022

(511) **3**

(740) 194

DOCKERS

(210) **542072** (540)

(730) **LEVI STRAUSS & CO.; US**

(220) 05/09/2022

(511) **3**

(740) 194



(210) **542073** (540)
(730) **ABZARADEL ROITMAN RAFAEL**; UY
(220) 05/09/2022
(511) **5 y 10**
(740) 220

(591) Tonos de azul , verde y rojo



(210) **542075** (540)
(730) **LUIS MARCELO VECINO**; UY
(220) 05/09/2022
(511) **19**
(740) 220

(591) Tonos de azul



(210) **542086** (540)
(730) **NV Bekaert SA**; BE
(220) 06/09/2022
(511) **6 (S/D), 11 (S/D), 19 (S/D) y 22 (S/D)**
(740) 144
(300) EM018686253 12/04/2022 EM



(210) **542089** (540)
(730) **OTADELER S.R.L.;** UY
(220) 06/09/2022
(511) **43 (S/D)**
(740) 144

(591) Amarillo y Negro

república
rotisería

(210) **542092** (540)
(730) **María Victoria Pereira Flores;** UY
(220) 06/09/2022
(511) **41**
(740) Pedro Murillo 6270, Montevideo, 11500,
Montevideo, Montevideo, UY

(591) verde, negro y blanco

CAMINA
Cine Ambiental
Montevideo

(210) **542101** (540)
(730) **POMAR S.R.L.;** UY
(220) 06/09/2022
(511) **31**
(740) 129

POMAR

(210) **542102**
(730) **POMAR S.R.L.**; UY
(220) 06/09/2022
(511) **33**
(740) 129

(540)

LIBERO

(210) **542103**
(730) **REINALDO DE LUCCA GALERATO**;
UY
(220) 06/09/2022
(511) **33**
(740) 129

(540)

CRESTA ROJA

(210) **542104**
(730) **REINALDO DE LUCCA GALERATO**;
UY
(220) 06/09/2022
(511) **33**
(740) 129

(540)

COSECHA NOBLE

(210) **542105** (540)
(730) **REINALDO DE LUCCA GALERATO;**
UY
(220) 06/09/2022
(511) **33**
(740) 129

(591) Negro, blanco.



(210) **542107** (540)
(730) **REINALDO DE LUCCA GALERATO;**
UY
(220) 06/09/2022
(511) **33**
(740) 129

(591) Violeta, dorado, negro, blanco.



(210) **542112** (540)
(730) **Clarios Energy Solutions Brasil Ltda.;** BR
(220) 06/09/2022
(511) **9 (S/D)**
(740) 144

DUREX

(210) **542117**

(540)

(730) **ESPÓSITO, MARIANA**; AR

(220) 06/09/2022

(511) **3**

(740) 201



(210) **542118**

(540)

(730) **Baudilio Eusebio Belo Calabia**; UY

(220) 06/09/2022

(511) **38 y 41**

(740) CEIBOS 650 (CASA ANGELITA),
ARAMINDA (Tel.fijo 43782468), ,
CANELONES, CANELONES, UY

TODO ES MILONGA

(210) **542120**

(540)

(730) **Monster Energy Company**; US

(220) 06/09/2022

(511) **32 (S/D)**

(740) 194

PREDATOR

(210) **542121** (540)
(730) **Lucia Moran**; UY
(220) 06/09/2022
(511) **35 (S/D)**
(740) Av. Sarandí Solís Mj10 S12, La Floresta,
15300, Departamento de Canelones,
Departamento de Canelones, UY

EL CLUB DEL QUESO

(210) **542122** (540)
(730) **INDUNET S.A.**; UY
(220) 06/09/2022
(511) **29**
(740) 194

(591) Pantones 1235C y 1655C



(210) **542125** (540)
(730) **ELECTROQUIMICA S.A.**; UY
(220) 06/09/2022
(511) **29, 30 y 31**
(740) 194

DINORA

(210) **542130** (540)
(730) **Lucia Moran**; UY
(220) 06/09/2022
(511) **29 (S/D)**
(740) Av. Sarandí Solís Mj10 S12, La Floresta,
15300, Departamento de Canelones,
Departamento de Canelones, UY

NOQUESO

(210) **542132** (540)
(730) **MABLE S.A.**; UY
(220) 06/09/2022
(511) **3, 5 y 21**
(740) 94

(591) No reivindica colores

The logo for 'Care up' is written in a stylized, cursive font. The word 'Care' is in a larger, more prominent script, and 'up' is smaller and positioned below it, with a small underline under the 'p'.

(210) **542136** (540)
(730) **Brain Labs Digital Ltd**; UK
(220) 06/09/2022
(511) **9 (S/D), 35 (S/D), 38 (S/D), 41 (S/D) y 42 (S/D)**
(740) 212

BRAINLABS

(210) **542138** (540)
(730) **EUROFARMA URUGUAY S.A.**; UY
(220) 06/09/2022
(511) **5**
(740) 201

LÉPTICO

(210) **542143** (540)
(730) **FORTER S.A.**; UY
(220) 06/09/2022
(511) **3, 18, 25 y 35**
(740) 189

(591) No se reivindican



(210) **542144** (540)
(730) **PINTELUX PAINTINGS S.A.**; UY
(220) 06/09/2022
(511) **2, 6, 8, 16, 35, 37 y 40**
(740) 245

(591) -



(210) **542148** (540)
(730) **SUMITOMO CHEMICAL COMPANY,
LIMITED**; JP
(220) 06/09/2022
(511) **1 (S/D) y 5 (S/D)**
(740) 212

CARVERO

(210) **542151** (540)
(730) **Visper S.A.**; UY
(220) 06/09/2022
(511) **35**
(740) 212



(210) **542155** (540)
(730) **PINTELUX PAINTINGS S.A.**; UY
(220) 06/09/2022
(511) **2**
(740) 245

(591) -



(210) **542156** (540)
(730) **PINTELUX PAINTINGS S.A.**; UY
(220) 06/09/2022
(511) **2**
(740) 245

(591) -



(210) **542157** (540)
(730) **Bayer Aktiengesellschaft**; DE
(220) 06/09/2022
(511) **9 (S/D), 10 (S/D), 35 (S/D), 38 (S/D), 42 (S/D) y 44 (S/D)**
(740) 205
(300) 018676825 23/03/2022 EM

CAL.AI

(210) **542160** (540)
(730) **BOYERCO S.A.**; UY
(220) 07/09/2022
(511) **30 (S/D)**
(740) clara 4611, Sayago, 12900, MONTEVIDEO,
MONTEVIDEO, UY

(591) Rojo y blanco



(210) **542165** (540)
(730) **VASWER COMPANY S.A.**; UY
(220) 07/09/2022
(511) **35, 36, 37 y 42**
(740) 189

(591) No se reivindican

HÄUSER

(210) **542167** (540)
(730) **CENTRO DE ENTRENAMIENTO DE
CABALLOS DEPORTIVOS (CE.CA.DE)
ASOCIACION CIVIL**; UY
(220) 07/09/2022
(511) **43**
(740) 201

(591) VERDE, GRIS, BLANCO



(210) **542168** (540)
(730) **Clarios Energy Solutions Brasil Ltda.**; BR
(220) 07/09/2022
(511) **9 (S/D)**
(740) 144



(210) **542169** (540)
(730) **TECHNOS DA AMAZÔNIA INDÚSTRIA
E COMÉRCIA S.A.**; BR
(220) 07/09/2022
(511) **9 (S/D)**
(740) 220

(591) TONOS DE ROJO



(210) **542170** (540)
(730) **Alcamp S.A.**; UY
(220) 07/09/2022
(511) **7 (S/D), 12 (S/D), 37 (S/D) y 40 (S/D)**
(740) Alamos 2301, A, 304, Montevideo, ,
Montevideo, Montevideo, UY

CUMMOTORS

(210) **542172** (540)
(730) **BAYERISCHE MOTOREN WERKE
AKTIENGESELLSCHAFT**; DE
(220) 07/09/2022
(511) **12 (S/D)**
(740) 216
(300) 302022103858.7/12 10/03/2022 DE

BMW ALPINA

(210) **542174** (540)
(730) **SRAM, LLC**; US
(220) 07/09/2022
(511) **25 (S/D)**
(740) 136
(300) 97/564839 25/08/2022 US

SRAM

(210) **542178** (540)
(730) **ABEMOL S.A.**; UY
(220) 07/09/2022
(511) **30 y 32**
(740) 217

(591) Pantones: BLACK; P 57-7 C; P 14-14 C; P
179-4 C

The logo for POWER LIFE features the word "POWER" in a bold, black, sans-serif font above the word "LIFE" in a similar font. A red lightning bolt graphic strikes through the letter "O" in "POWER". A registered trademark symbol (®) is located to the upper right of the word "LIFE".

(210) **542180** (540)
(730) **H. KRULL & C. S.P.A.**; IT
(220) 07/09/2022
(511) **3 (S/D), 21 (S/D) y 35 (S/D)**
(740) 144

ACCA KAPPA
dal 1869

(210) **542182** (540)
(730) **Essity Hygiene and Health Aktiebolag; SE**
(220) 07/09/2022
(511) **5 (S/D) y 25 (S/D)**
(740) 194
(300) 2709871 - clase 5 10/03/2022 MX y
2709874 - clase 25 10/03/2022 MX
(591) blanco, rosado, azul



(210) **542183** (540)
(730) **VILACITY S.A.; UY**
(220) 07/09/2022
(511) **5, 31 y 35**
(740) 194

(591) variaciones de verde CMYK: 39B54A y
blanco



(210) **542184** (540)
(730) **PIZZA DATA INTERNATIONAL, LLC.;**
US
(220) 07/09/2022
(511) **43**
(740) 144

(591) Rojo y Blanco



(210) **542185** (540)
(730) **SOL MINERALES Y SERVICIOS S.A.;**
AR
(220) 07/09/2022
(511) **31**
(740) 201

WHITE CAT

(210) **542186** (540)
(730) **TCT MOBILE EUROPE SAS; FR**
(220) 07/09/2022
(511) **9 (S/D)**
(740) 201

ONETOUCH

(210) **542188** (540)
(730) **ABITAB S.A.; UY**
(220) 07/09/2022
(511) **36**
(740) 201

(591) PANTONE 295C, PANTONE 200C,
PANTONE 299C

billetera
Abitab

(210) **542190** (540)
(730) **LUMINOVA PHARMA CORPORATION**
GmbH; CH
(220) 07/09/2022
(511) **5 (S/D)**
(740) 212

(591) violeta



(210) **542194** (540)
(730) **PURATOS N.V.; BE**
(220) 07/09/2022
(511) **29 (S/D)**
(740) 34

PASSIONATA

(210) **542195** (540)
(730) **BRUNA RUELA TAVARES ME; BR**
(220) 07/09/2022
(511) **3 (S/D)**
(740) 34

BRUNA TAVARES

(210) **542203**
(730) **Mint Condition S.A.S.**; UY
(220) 07/09/2022
(511) **20 y 35**
(740) Arq. Ernesto Leborgne 7465, Montevideo,
11100, Montevideo, Montevideo, UY

(540)



(210) **542211**
(730) **ANA GRACIELA CIARLO PEREZ**; UY
(220) 08/09/2022
(511) **9 y 38**
(740) 192

(540)

(591) Rojo y blanco



(210) **542212**
(730) **FINCA 1948 S.A.**; AR
(220) 08/09/2022
(511) **33 (S/D)**
(740) 212

(540)

BODEGA URQO PALO SANTO

(210) **542213** (540)
(730) **ÖNTAR TARIM ALETLERİ SANAYİ VE
TİCARET LIMITED SİRKETİ; TR**
(220) 08/09/2022
(511) **7 (S/D)**
(740) 192

(591) Verde y Gris



(210) **542214** (540)
(730) **PABLO ARTIGAS; UY**
(220) 08/09/2022
(511) **35**
(740) Félix Vidarte 649 bis, Las Piedras, 90200,
Canelones, Canelones, UY

**DÍA DE LA PAZ / SEMANA DE
LA PAZ**

(210) **542215** (540)
(730) **FRANCO GUSTAVO SILVEIRA
ZAMORA; UY**
(220) 08/09/2022
(511) **35**
(740) 28

HOGARUP

(210) **542216**
(730) **TA -TA S.A.**; UY
(220) 08/09/2022
(511) **18 y 25**
(740) 245

(540)

(591) -

H&G

(210) **542223**
(730) **Mercedes-Benz Group AG**; DE
(220) 08/09/2022
(511) **3 (S/D), 9 (S/D), 16 (S/D) y 28 (S/D)**
(740) 144
(300) 018676454 23/03/2022 EM

(540)

The logo consists of four slanted parallel bars followed by the letters 'AMG' in a bold, sans-serif font.

(210) **542224**
(730) **MIPAC SRL**; PY
(220) 08/09/2022
(511) **6 y 20**
(740) 144

(540)

The logo features a large, hollow downward-pointing triangle above the word 'HYDRATE' in a bold, sans-serif font.

(210) **542226** (540)
(730) **BYD COMPANY LIMITED; CN**
(220) 08/09/2022
(511) **12 (S/D)**
(740) 201

TANG

(210) **542227** (540)
(730) **BYD COMPANY LIMITED; CN**
(220) 08/09/2022
(511) **12 (S/D)**
(740) 201

YUAN

(210) **542228** (540)
(730) **BYD COMPANY LIMITED; CN**
(220) 08/09/2022
(511) **12 (S/D)**
(740) 201

D1

(210) **542229** (540)
(730) **BYD COMPANY LIMITED; CN**
(220) 08/09/2022
(511) **12 (S/D)**
(740) 201

HAN

(210) **542230** (540)
(730) **BYD COMPANY LIMITED; CN**
(220) 08/09/2022
(511) **12 (S/D)**
(740) 201

QIN

(210) **542231** (540)
(730) **BYD COMPANY LIMITED; CN**
(220) 08/09/2022
(511) **12 (S/D)**
(740) 201

SONG

(210) **542232** (540)
(730) **LA BUENA ESTRELLA S.A.;** UY
(220) 08/09/2022
(511) **5**
(740) 34

BIO TICKXAN

(210) **542233** (540)
(730) **LA BUENA ESTRELLA S.A.;** UY
(220) 08/09/2022
(511) **44**
(740) 34

TICKXAN

(210) **542234** (540)
(730) **LA BUENA ESTRELLA S.A.;** UY
(220) 08/09/2022
(511) **44**
(740) 34

TICXAN

(210) **542235** (540)
(730) **LA BUENA ESTRELLA S.A.**; UY
(220) 08/09/2022
(511) **5 y 44**
(740) 34

BIOXAN

(210) **542238** (540)
(730) **Hugo Javier Fagundez Suarez**; UY
(220) 08/09/2022
(511) **41 (S/D)**
(740) Calle 9 esquina Av.Mario Ferreira, Parque del
Plata Sur, , Canelones, Canelones, UY

(591) negro, verde y blanco



(210) **542246** (540)
(730) **RODRIGUEZ VAGHI JAVIER**; UY
(220) 08/09/2022
(511) **35 y 41 (S/D)**
(740) 219



(210) **542248** (540)
(730) **OPIA SAS; UY**
(220) 08/09/2022
(511) **11**
(740) 212

(591) AZUL Y BLANCO



(210) **542249** (540)
(730) **OPIA SAS; UY**
(220) 08/09/2022
(511) **35**
(740) 212

(591) AZUL Y BLANCO



(210) **542250** (540)
(730) **OPIA SAS; UY**
(220) 08/09/2022
(511) **40**
(740) 212

(591) AZUL Y BLANCO



(210) **542251**
(730) **OPIA SAS**; UY
(220) 08/09/2022
(511) **42**
(740) 212

(540)

(591) AZUL Y BLANCO



(210) **542252**
(730) **THE MEDIAPRO STUDIO S.L.**; ES
(220) 09/09/2022
(511) **38 (S/D) y 41 (S/D)**
(740) 220

(540)

MOONLYON

(210) **542255**
(730) **Unilever Global IP Limited**; GB
(220) 09/09/2022
(511) **3 (S/D)**
(740) 136

(540)

ODORONO

(210) **542257** (540)
(730) **Shell Brands International AG**; CH
(220) 09/09/2022
(511) **4 (S/D)**
(740) 136

SARAPHALT

(210) **542258** (540)
(730) **WALTER HUGO S.A.**; UY
(220) 09/09/2022
(511) **20**
(740) Circunvalación Durango 318/2C,
Montevideo, 11000, Montevideo,
Montevideo, UY

(591) bordeaux y blanco



(210) **542259** (540)
(730) **WALTER HUGO S.A.**; UY
(220) 09/09/2022
(511) **20**
(740) Circunvalación Durango 318/2C,
Montevideo, 11000, Montevideo,
Montevideo, UY

(591) blanco, negro y bordeaux



(210) **542261** (540)
(730) **GARCÍA PICCIOLI, PAOLA XIMENA;**
UY
(220) 09/09/2022
(511) **9 (S/D)**
(740) 189

YAESTÁ

(210) **542262** (540)
(730) **Magdalena Migliavacca; AR**
(220) 09/09/2022
(511) **44**
(740) Calle 20 Edificio La Candelaria Ap. 102 y
103, Maldonado, 20000, Punta del Este,
Punta del Este, UY



(210) **542263** (540)
(730) **Tenro AG; CH**
(220) 09/09/2022
(511) **25 (S/D)**
(740) 240

THE ROGER

(210) **542265** (540)
(730) **SEGUROS SURA S.A.**; UY
(220) 09/09/2022
(511) **36**
(740) 205

(591) Blanco, Pantone 286 C y Pantone 3125 C



(210) **542268** (540)
(730) **APPLE INC.**; US
(220) 09/09/2022
(511) **9 y 42**
(740) 245
(300) 86.948 12/07/2022 JM

DYNAMIC ISLAND

(210) **542269** (540)
(730) **APPLE INC.**; US
(220) 09/09/2022
(511) **9 (S/D)**
(740) 245
(300) 2022-530 13/07/2022 LI

A16 BIONIC

(210) **542273**
(730) **FAMINTER S.A.**; UY
(220) 09/09/2022
(511) **5**
(740) 144

(540)

GINO-PARCHE

(210) **542274**
(730) **BYRNA TECHNOLOGIES INC.**; US
(220) 09/09/2022
(511) **13 (S/D)**
(740) 144

(540)

BYRNA

(210) **542275**
(730) **BYRNA TECHNOLOGIES INC.**; US
(220) 09/09/2022
(511) **13 (S/D)**
(740) 144

(540)



(210) **542280** (540)
(730) **FAMINTER S.A.**; UY
(220) 09/09/2022
(511) **5**
(740) 217

(591) Azul, Celeste y Blanco

The logo for MONTEVIAL, featuring a stylized blue 'M' followed by the word 'MONTEVIAL' in a blue, sans-serif font.

(210) **542283** (540)
(730) **MYROSUR S.A.**; UY
(220) 09/09/2022
(511) **29, 30 y 31**
(740) 245

(591) cyan, magenta y blanco.



(210) **542284** (540)
(730) **RUMBO ARRUTI, PABLO JAVIER y**
TORRES, SANDRA; AR
(220) 09/09/2022
(511) **10**
(740) 201

COMPEX

(210) **542290** (540)

(730) **Gonzalo Diez**; UY

(220) 09/09/2022

(511) **28**

(740) 21 de setiembre 2775 apto. 1002,
Montevideo, , Montevideo, Montevideo, UY

(591) Negro

TIWAZ
TRAIL & FITNESS STORE

(210) **542291** (540)

(730) **JIANGSU DONGCHENG POWER
TOOLS CO., LTD.**; CN

(220) 09/09/2022

(511) **7 (S/D), 8 (S/D) y 9 (S/D)**

(740) 34

(591) 0

DCK

(210) **542292** (540)

(730) **JIANGSU DONGCHENG POWER
TOOLS CO., LTD.**; CN

(220) 09/09/2022

(511) **7 (S/D), 8 (S/D) y 9 (S/D)**

(740) 34

(591) 0

DongCheng

(210) **542294** (540)
(730) **JIANGSU DONGCHENG POWER
TOOLS CO., LTD.;** CN
(220) 09/09/2022
(511) **7 (S/D), 8 (S/D) y 9 (S/D)**
(740) 34

(591) 0

DCA

(210) **542295** (540)
(730) **Inbicon A/S;** DK
(220) 09/09/2022
(511) **4 (S/D), 35 (S/D), 36 (S/D), 37 (S/D), 39
(S/D), 40 (S/D), 41 (S/D) y 42 (S/D)**
(740) 219

ORSTED

(210) **542296** (540)
(730) **DANI CONDUTORES ELECTRICOS
LTDA.;** BR
(220) 09/09/2022
(511) **9 (S/D) y 12 (S/D)**
(740) 34

(591) NEGRO, ROJO

Dni

(210) **542297** (540)
(730) **MALAN AGUIRRE ANALIA,
PRILASSNIG CUNHA MARIA INES Y
OTROS SOCIEDAD DE HECHO; UY**
(220) 09/09/2022
(511) **35, 36 y 41**
(740) 34

(591) AZUL, CELESTE y ROJO



(210) **542298** (540)
(730) **Inbicon A/S; DK**
(220) 09/09/2022
(511) **4 (S/D), 35 (S/D), 36 (S/D), 37 (S/D), 39
(S/D), 40 (S/D), 41 (S/D) y 42 (S/D)**
(740) 219



(210) **542299** (540)
(730) **Inbicon A/S; DK**
(220) 09/09/2022
(511) **4 (S/D), 35 (S/D), 36 (S/D), 37 (S/D), 39
(S/D), 40 (S/D), 41 (S/D) y 42 (S/D)**
(740) 219



(210) **542300** (540)
(730) **Inbicon A/S**; DK
(220) 09/09/2022
(511) **4 (S/D), 35 (S/D), 36 (S/D), 37 (S/D), 39 (S/D), 40 (S/D), 41 (S/D) y 42 (S/D)**
(740) 219

(591) celeste

The logo for Orsted, featuring the word "Orsted" in a blue sans-serif font with a blue circle containing a white stylized 'O' symbol to its left.

(210) **542308** (540)
(730) **SOREMARTEC S.A.**; UY
(220) 12/09/2022
(511) **5 (S/D) y 30 (S/D)**
(740) 212

FULFIL

(210) **542309** (540)
(730) **Juan Balbuena**; UY
(220) 12/09/2022
(511) **37 (S/D)**
(740) Ayui 938, PAYSANDÚ, , PAYSANDÚ,
PAYSANDÚ, UY

(591) Azul Negro Blanco

The logo for LIPIN S.A., featuring the word "LIPIN" in a bold, blue, sans-serif font with "S.A." in a smaller font to its right. Below "LIPIN" is the text "CONSTRUCCION VIAL" in a smaller, blue, sans-serif font. The logo is accompanied by a stylized graphic of blue diagonal lines forming a triangular shape above the text.

(210) **542310**
(730) **BLUM SA; UY**
(220) 12/09/2022
(511) **20**
(740) 220

(540)

(591) Tonos de rojo



(210) **542313**
(730) **SINDICATO MEDICO DEL URUGUAY;**
UY
(220) 12/09/2022
(511) **16 y 44**
(740) 220

(540)

(591) Tonos de azul



(210) **542315**
(730) **FMC Agro Singapore Pte Ltd.; SG**
(220) 12/09/2022
(511) **5 (S/D)**
(740) 201

(540)

HERO

(210) **542317** (540)
(730) **Patricia Antonia Rennis Gómez**; AR
(220) 12/09/2022
(511) **30 (S/D)**
(740) 34 y 55, Balneario Buenos Aires, 20002,
Maldonado, Maldonado, UY

(591) Azul, blanco y negro



(210) **542318** (540)
(730) **Nomis LLC**; US
(220) 12/09/2022
(511) **7 y 8**
(740) 201

MILESCRAFT

(210) **542325** (540)
(730) **AGAM LTDA.**; UY
(220) 12/09/2022
(511) **3 y 5**
(740) 144

ANTALGIA

(210) **542330** (540)
(730) **SOUTHDEVELOPMENTS S.A.S;** UY
(220) 12/09/2022
(511) **42**
(740) 94

BOOSTMONT

(210) **542338** (540)
(730) **KOMATSU LTD.;** JP
(220) 12/09/2022
(511) **8 (S/D), 9 (S/D), 14 (S/D), 16 (S/D), 18 (S/D), 21 (S/D), 24 (S/D), 25 (S/D) y 28 (S/D)**
(740) 34

(591) 0

KOMATSU

(210) **542340** (540)
(730) **DELIBRA S.A.;** UY
(220) 12/09/2022
(511) **5 (S/D)**
(740) 245

ROSEDEZ

(210) **542341** (540)
(730) **Ridella`s group Sas**; UY
(220) 12/09/2022
(511) **36 (S/D)**
(740) Cerrito 420-306 Montevideo, Ciudad Vieja,
Montevideo, 1100, Monrevideo, Monrevideo,
UY



(210) **542344** (540)
(730) **Specialized Bicycle Components, Inc.**; US
(220) 12/09/2022
(511) **12 (S/D)**
(740) 194
(300) 97546488 12/08/2022 US

MEEPER

(210) **542349** (540)
(730) **ANDRES GALLO DUBOURG**; UY
(220) 12/09/2022
(511) **3, 30, 31 y 35**
(740) 220

(591) Tonos de celeste , amarillo y rojo



(210) **542352** (540)
(730) **LUMINOVA PHARMA CORPORATION**
GmbH; CH
(220) 12/09/2022
(511) **5 (S/D)**
(740) 212

BENSIBEN

(210) **542353** (540)
(730) **LUMINOVA PHARMA CORPORATION**
GmbH; CH
(220) 12/09/2022
(511) **5 (S/D)**
(740) 212

MAXTAR

(210) **542354** (540)
(730) **LUMINOVA PHARMA CORPORATION**
GmbH; CH
(220) 12/09/2022
(511) **5 (S/D)**
(740) 212

VEKPROFEN

(210) **542355** (540)
(730) **LUMINOVA PHARMA CORPORATION**
GmbH; CH
(220) 12/09/2022
(511) **5 (S/D)**
(740) 212

ZOBUL

(210) **542356** (540)
(730) **THELEATHERTECH S.A.; UY**
(220) 12/09/2022
(511) **35 (S/D) y 39 (S/D)**
(740) Ave. Italia 5052, Montevideo, 11400,
Montevideo, Montevideo, UY

(591) verde, gris



(210) **542357** (540)
(730) **Durman Esquivel S.A.; CR**
(220) 12/09/2022
(511) **11 (S/D) y 17 (S/D)**
(740) 218

(591) Blanco, Pantone 072C



(210) **542363** (540)
(730) **CAMILO CUBA; UY**
(220) 13/09/2022
(511) **35 y 37**
(740) 144

(591) Celeste y Negro

The logo for 'Klin!' features the word 'Klin!' in a bold, sans-serif font. The 'K' is blue, and the 'lin!' is black. The exclamation point is also black.

(210) **542364** (540)
(730) **MOLINOS DEL ATLANTICO S.A.S.; CO**
(220) 13/09/2022
(511) **30 (S/D)**
(740) 181

(591) Azul, cyan, magenta, amarillo, negro, blanco,
beige, café, Pantones No. 2387C, 485C y
123C



(210) **542365** (540)
(730) **GARRIDO FIALHIO MICAELA
EDELWEISS Y CASTILLO
OYARZABAL MARIANA SOCIEDAD
DE HECHO; UY**
(220) 13/09/2022
(511) **41 (S/D)**
(740) Andes 1122, 202, Montevideo, 11200,
Montevideo, Montevideo, UY

(591) Azul/lila



(210) **542367** (540)
(730) **ELDINAR S.A.**; UY
(220) 13/09/2022
(511) **3, 35 y 44**
(740) 220

(591) Tonos de rosado



(210) **542368** (540)
(730) **ACUARELA S.R.L.**; AR
(220) 13/09/2022
(511) **2 y 35**
(740) 179

(591) rojo, gris, naranja, blanco



(210) **542371** (540)
(730) **WUXI PUTIAN IRON CORE CO.,LTD.**;
CN
(220) 13/09/2022
(511) **6 (S/D) y 9 (S/D)**
(740) 144



(210) **542372** (540)
(730) **Astori Estructuras S.A.**; AR
(220) 13/09/2022
(511) **19 (S/D)**
(740) 144

picast

(210) **542374** (540)
(730) **FLO MAGAZACILIK VE PAZARLAMA**
ANONIM SIRKETI; TR
(220) 13/09/2022
(511) **25 (S/D)**
(740) 216

(591) naranja y negro



(210) **542381** (540)
(730) **UPL Mauritius Limited**; MU
(220) 13/09/2022
(511) **1 (S/D) y 5 (S/D)**
(740) 144

(591) Verde, Blanco y Negro



(210) **542382** (540)
(730) **UPL Mauritius Limited**; MU
(220) 13/09/2022
(511) **1 (S/D) y 5 (S/D)**
(740) 144

(591) Rosado, Blanco y Negro



(210) **542383** (540)
(730) **UPL Mauritius Limited**; MU
(220) 13/09/2022
(511) **1 (S/D) y 5 (S/D)**
(740) 144

(591) Azul, Blanco y Negro



(210) **542384** (540)
(730) **UPL Mauritius Limited**; MU
(220) 13/09/2022
(511) **1 (S/D) y 5 (S/D)**
(740) 144

(591) Rosado, Blanco y Negro



(210) **542385**
(730) **UPL Mauritius Limited; MU**
(220) 13/09/2022
(511) **1 (S/D) y 5 (S/D)**
(740) 144

(540)

(591) Amarillo, Blanco y Negro



(210) **542386**
(730) **UPL Mauritius Limited; MU**
(220) 13/09/2022
(511) **1 (S/D) y 5 (S/D)**
(740) 144

(540)

(591) Amarillo Pálido, Blanco y Negro



(210) **542387**
(730) **UPL Mauritius Limited; MU**
(220) 13/09/2022
(511) **1 (S/D) y 5 (S/D)**
(740) 144

(540)

(591) Azul, Blanco y Negro



(210) **542388** (540)
(730) **UPL Mauritius Limited**; MU
(220) 13/09/2022
(511) **1 (S/D) y 5 (S/D)**
(740) 144

(591) Anaranjado, Blanco y Negro

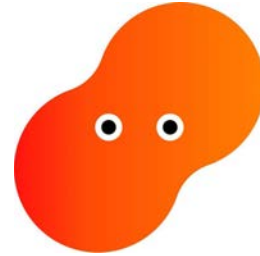

(210) **542389** (540)
(730) **UPL Mauritius Limited**; MU
(220) 13/09/2022
(511) **1 (S/D) y 5 (S/D)**
(740) 144

(591) Purpura, Blanco y Negro



(210) **542392** (540)
(730) **EGA Onshore Investments LLC**; AE
(220) 13/09/2022
(511) **6 (S/D)**
(740) 179
(300) 381763 22/08/2022 AE

CELESTIAL

(210) **542396** (540)
(730) **Augmented Reality Concepts, Inc.**; US
(220) 13/09/2022
(511) **9 (S/D) y 42 (S/D)**
(740) 205

IMPEL

(210) **542399** (540)
(730) **EGA Onshore Investments LLC**; AE
(220) 13/09/2022
(511) **6 (S/D)**
(740) 179
(300) 381764 22/08/2022 AE

MINIMAL

(210) **542400** (540)
(730) **FLO MAGAZACILIK VE PAZARLAMA**
ANONIM SIRKETI; TR
(220) 13/09/2022
(511) **25 (S/D)**
(740) 216

(591) Blanco y negro

LUMBERJACK

(210) **542401** (540)
(730) **Clark Foods, Inc.;** US
(220) 13/09/2022
(511) **32 (S/D)**
(740) 194

REÀL INFUSED EXOTICS

(210) **542402** (540)
(730) **SYNGENTA CROP PROTECTION AG;**
CH
(220) 13/09/2022
(511) **1 (S/D)**
(740) 194

NUELLO

(210) **542408** (540)
(730) **Bernardo Ferreira;** UY
(220) 13/09/2022
(511) **30 (S/D)**
(740) Av Argentina M149 s19, Parque del Plata,
15300, Canelones, Canelones, UY

TSUNAMI FREE

(210) **542409** (540)
(730) **TOSKANI S.L.**; ES
(220) 13/09/2022
(511) **5 (S/D)**
(740) 34

(591) 0

 **TOSKANIMED**

(210) **542410** (540)
(730) **FERNÁNDEZ GARAYALDE, NESTOR**
MARTÍN; UY
(220) 13/09/2022
(511) **3**
(740) 34

(591) 0



(210) **542411** (540)
(730) **MIRA, ESTEBAN PABLO**; AR
(220) 13/09/2022
(511) **34 (S/D)**
(740) 34

(591) ROJO. NEGRO

 **RÖK**

(210) **542412** (540)
(730) **INFINIA S.A.S**; UY
(220) 13/09/2022
(511) **36 y 42**
(740) Avenida Sarmiento número 2393 apartamento
402, MONTEVIDEO, 11300,
MONTEVIDEO, MONTEVIDEO, UY

(591) celeste, verde agua y gris.



(210) **542413** (540)
(730) **KSM REALTY ADMINISTRAÇÃO E
PARTICIPAÇÃO LTDA**; BR
(220) 13/09/2022
(511) **41 (S/D)**
(740) 34

BEYOND THE CLUB

(210) **542417** (540)
(730) **SILVA BARRIOS, MATHIAS LUCIANO y
SILVA, WELLINGTON**; UY
(220) 14/09/2022
(511) **41**
(740) 189

(591) Blanco, negro, naranja



(210) **542422** (540)
(730) **ROTUNDAMENTE S.A.S.**; UY
(220) 14/09/2022
(511) **43**
(740) 201

OTERO

(210) **542425** (540)
(730) **Nub Technologies Ltd**; GB
(220) 14/09/2022
(511) **1 (S/D)**
(740) 181
(300) UK00003765119 14/03/2022 GB

NUB

(210) **542426** (540)
(730) **MEGAAGRO URUGUAY S.A.**; UY
(220) 14/09/2022
(511) **31, 35, 36 y 44**
(740) 201

(591) ROJO, VERDE, NEGRO, BLANCO



(210) **542430** (540)
(730) **Isis Boetto**; UY
(220) 14/09/2022
(511) **3 (S/D) y 5 (S/D)**
(740) camino Ortelio s/n, Sauce, 90800, Canelones,
Canelones, UY

(591) C:5 M:10 Y:60 K:0 ; C:15 M:20 Y:70 K:0 ;
C:40 M:40 Y:95 K:15



(210) **542432** (540)
(730) **SOLSIRE S.A.**; UY
(220) 14/09/2022
(511) **29 (S/D) y 30 (S/D)**
(740) 94

(591) negro, fucsia



(210) **542434** (540)
(730) **LONEMAR S.A.**; UY
(220) 14/09/2022
(511) **36 y 37**
(740) 144

(591) PANTONE 7557 C, PANTONE 539 C



(210) **542435** (540)
(730) **Grupo Bongiovanni S.A.**; AR
(220) 14/09/2022
(511) **31 (S/D)**
(740) 144

(591) pantone 683 C y pantone 715 C

The logo for 'nutribon' features the brand name in a lowercase, rounded, purple font. The letter 'i' in 'nutri' has a small orange dot above it.

(210) **542436** (540)
(730) **Grupo Bongiovanni S.A.**; AR
(220) 14/09/2022
(511) **31 (S/D)**
(740) 144

(591) pantone 320 C

The logo for 'MATUTE' consists of the brand name in a bold, teal, uppercase font with a slightly irregular, hand-drawn style.

(210) **542438** (540)
(730) **SOLSIRE S.A.**; UY
(220) 14/09/2022
(511) **30 (S/D)**
(740) 94

(591) fucsia, celeste, blanco

The logo for 'PURI POP' features the word 'PURI' in a bold, pink, uppercase font, and 'POP' in a white, uppercase font inside a teal cloud-like shape. Below 'PURI' are the letters 'P O P C O R N' in a smaller, pink, uppercase font.

(210) **542441** (540)
(730) **Marco Financial SAS**; UY
(220) 14/09/2022
(511) **36**
(740) 144

(591) HEX: #29D3B1

The logo for 'marco' is written in a lowercase, teal-colored, sans-serif font.

(210) **542442** (540)
(730) **SOLSIRE S.A.**; UY
(220) 14/09/2022
(511) **29**
(740) 94

(591) fucsia, amarillo, blanco

The logo for 'PURI VEGGIE RAMITAS' features the word 'PURI' in large, bold, purple letters. To its right is a yellow speech bubble containing the word 'VEGGIE' in white. Below 'PURI' is the word 'RAMITAS' in smaller, purple, spaced-out letters.

(210) **542443** (540)
(730) **SOLSIRE S.A.**; UY
(220) 14/09/2022
(511) **29**
(740) 94

(591) amarillo

The logo for 'HIPs N'MORE BY PURI' features the word 'HIPs' in large, bold, yellow letters with a slight shadow. Below it is 'N'MORE' in smaller, bold, yellow letters, and at the bottom is 'BY PURI' in even smaller, bold, yellow letters, flanked by two horizontal lines.

(210) **542444**
(730) **SOLSIRE S.A.**; UY
(220) 14/09/2022
(511) **29 y 30**
(740) 94

(540)

(591) negro, blanco



(210) **542445**
(730) **CODERE NEWCO, S.A.U.**; ES
(220) 14/09/2022
(511) **9 (S/D), 28 (S/D), 35 (S/D), 38 (S/D), 41 (S/D), 42 (S/D) y 43 (S/D)**
(740) 181
(300) 018754854 01/09/2022 EM
(591) Pantones No. 3561 C, 3561 U, 432 C, Black 6 U.

(540)



(210) **542446**
(730) **ROTUNDAMENTE S.A.S.**; UY
(220) 14/09/2022
(511) **35**
(740) 201

(540)

(591) VIOLETA, BLANCO



(210) **542449** (540)
(730) **CONSULTORES Y
ADMINISTRADORES DE EMPRESAS
S.R.L. y J.P.D. ASOCIADOS S.A.;** UY
(220) 14/09/2022
(511) **35 y 45**
(740) 118

(591) tonos de azul y turquesa



(210) **542452** (540)
(730) **Soho Formats LLC;** US
(220) 14/09/2022
(511) **41 (S/D)**
(740) 94
(300) 97437753 01/06/2022 US

ENAMORÁNDONOS: LA ISLA

(210) **542460** (540)
(730) **CODERE NEWCO, S.A.U.;** ES
(220) 14/09/2022
(511) **9 (S/D), 28 (S/D), 35 (S/D), 38 (S/D), 41
(S/D), 42 (S/D) y 43 (S/D)**
(740) 181
(300) 018755463 01/09/2022 EM
(591) Pantones No. 3561 C, 3561 U, 432 C, Black 6
U.



(210) **542464**

(540)

(730) **BETO CARRERO GESTÃO DE
MARCAS LTDA; BR**

(220) 14/09/2022

(511) **25 (S/D)**

(740) 194



(210) **542465**

(540)

(730) **VRIO CORP.; US**

(220) 14/09/2022

(511) **35 (S/D), 38 (S/D) y 41 (S/D)**

(740) 218

(591) Negro, Pantone 333 C y Pantone 2728 C



(210) **542466**

(540)

(730) **BETO CARRERO GESTÃO DE
MARCAS LTDA; BR**

(220) 14/09/2022

(511) **28 (S/D)**

(740) 194



(210) **542468** (540)
(730) **BETO CARRERO GESTÃO DE**
MARCAS LTDA; BR
(220) 14/09/2022
(511) **35 (S/D)**
(740) 194



(210) **542471** (540)
(730) **BETO CARRERO GESTÃO DE**
MARCAS LTDA; BR
(220) 14/09/2022
(511) **41 (S/D)**
(740) 194



(210) **542472** (540)
(730) **BETO CARRERO GESTÃO DE**
MARCAS LTDA; BR
(220) 14/09/2022
(511) **43 (S/D)**
(740) 194



(210) **542474**

(540)

(730) **BETO CARRERO GESTÃO DE
MARCAS LTDA; BR**

(220) 14/09/2022

(511) **25 (S/D)**

(740) 194

BETO CARRERO WORLD

(210) **542476**

(540)

(730) **Jose Ignacio Lazaro Salmini; UY**

(220) 14/09/2022

(511) **35**

(740) Martin Salaberry vivienda numero 30,
Durazno, 97000, Durazno, Durazno, UY

(591) celeste, azul, blanco, negro



(210) **542477**

(540)

(730) **BETO CARRERO GESTÃO DE
MARCAS LTDA; BR**

(220) 14/09/2022

(511) **28 (S/D)**

(740) 194

BETO CARRERO WORLD

(210) **542478** (540)
(730) **BETO CARRERO GESTÃO DE**
MARCAS LTDA; BR
(220) 14/09/2022
(511) **35 (S/D)**
(740) 194

BETO CARRERO WORLD

(210) **542479** (540)
(730) **BETO CARRERO GESTÃO DE**
MARCAS LTDA; BR
(220) 14/09/2022
(511) **41 (S/D)**
(740) 194

BETO CARRERO WORLD

(210) **542481** (540)
(730) **BETO CARRERO GESTÃO DE**
MARCAS LTDA; BR
(220) 14/09/2022
(511) **43 (S/D)**
(740) 194

BETO CARRERO WORLD

(210) **542483** (540)
(730) **OPRUMIN S.A.**; UY
(220) 14/09/2022
(511) **12**
(740) 34

(591) 0

Vital
QUICK

(210) **542484** (540)
(730) **ARASHI VISION INC.**; CN
(220) 14/09/2022
(511) **9 (S/D)**
(740) 34

(591) 0

Insta360

(210) **542490** (540)
(730) **Pasaco S.A.**; UY
(220) 14/09/2022
(511) **7, 11 y 12**
(740) 101

YF

(210) **542491** (540)
(730) **Organización Internacional Agropecuaria**
S.A; AR
(220) 14/09/2022
(511) **42 (S/D)**
(740) 101

(591) VERDE NEGRO BLANCO



(210) **542492** (540)
(730) **CENTRO CEIBAL PARA EL APOYO A**
LA EDUCACION DE LA NIÑEZ Y LA
ADOLESCENCIA; UY
(220) 15/09/2022
(511) **9 y 41**
(740) 220

(591) Tonos de azul



(210) **542494** (540)
(730) **Raúl Calaña;** CU
(220) 15/09/2022
(511) **43**
(740) Nueva Palmira 1967, Montevideo, 11800,
Montevideo, Montevideo, UY



(210) **542498** (540)
(730) **GOCCO CONFEC S.A.**; ES
(220) 15/09/2022
(511) **24 (S/D), 25 (S/D) y 35 (S/D)**
(740) 201

GOCCO

(210) **542506** (540)
(730) **Sunnova Energy Corporation**; US
(220) 15/09/2022
(511) **7 (S/D), 9 (S/D), 35 (S/D), 36 (S/D), 37 (S/D), 39 (S/D), 40 (S/D) y 42 (S/D)**
(740) 194

SUNNOVA

(210) **542509** (540)
(730) **BYD Company Limited**; CN
(220) 15/09/2022
(511) **12 (S/D)**
(740) 201



(210) **542512** (540)
(730) **TOYOTA JIDOSHA KABUSHIKI
KAISHA (also trading as TOYOTA
MOTOR CORPORATION); JP**
(220) 15/09/2022
(511) **12 (S/D)**
(740) 94

STOUT

(210) **542513** (540)
(730) **LABORATORIO GADOR S.A.; UY**
(220) 15/09/2022
(511) **5**
(740) 165

NUSINEREN

(210) **542518** (540)
(730) **SUMITOMO CHEMICAL ARGENTINA
S.A.; AR**
(220) 15/09/2022
(511) **5 (S/D)**
(740) 144

ZETHAMAXX

(210) **542529** (540)
(730) **RMA ARQUITECTURA LTDA**; UY
(220) 15/09/2022
(511) **42 (S/D)**
(740) 186

RMA RAVECCA
MONTANO
ARTAGAVEYTIA
ARQUITECTURA

(210) **542534** (540)
(730) **Samsung Electronics Co., Ltd.**; KR
(220) 15/09/2022
(511) **7 (S/D)**
(740) 194
(300) 70-2022-0000321 16/03/2022 KR

SPACEMAX

(210) **542536** (540)
(730) **JOHNSON & JOHNSON**; US
(220) 15/09/2022
(511) **10 (S/D)**
(740) 194

ENSEAL

(210) **542538** (540)
(730) **María Belén Mundemurra Archs; UY**
(220) 15/09/2022
(511) **41 (S/D)**
(740) Rivera 3131 Apto 603, Montevideo, ,
Montevideo, Montevideo, UY

RADIANTE EXPERIENCIAS EN JUEGO

(210) **542544** (540)
(730) **CESIM CO JUPITER S.A.; UY**
(220) 15/09/2022
(511) **3**
(740) 201

(591) NEGRO, ROJO, BLANCO

The logo for 'mells' is displayed in a lowercase, serif font. The letters 'm', 'e', 'l', and 'l' are black, while the 's' is a dark red color.

(210) **542547** (540)
(730) **COPIZ PAEZ, NOELIA; UY**
(220) 15/09/2022
(511) **35 y 42**
(740) 201

VIA STUDIO

(210) **542549** (540)
(730) **COPIZ PAEZ, NOELIA**; UY
(220) 15/09/2022
(511) **35**
(740) 201

COOL DOG

(210) **542553** (540)
(730) **UBESUR S.A.**; UY
(220) 15/09/2022
(511) **35**
(740) 163

(591) azul, rojo, blanco

MINIMERCADOS 

(210) **542554** (540)
(730) **Catbe S.R.L.**; UY
(220) 15/09/2022
(511) **35**
(740) 101

(591) NEGRO CELESTE

topaz
home

(210) **542555** (540)
(730) **Rural LLC; US**
(220) 16/09/2022
(511) **35 y 39**
(740) 172

(591) VERDE, naranja y blanco



(210) **542557** (540)
(730) **FILLERS SAS; UY**
(220) 16/09/2022
(511) **3 y 44**
(740) 220



(210) **542558** (540)
(730) **LUCIENNE VAN HOFF; UY**
(220) 16/09/2022
(511) **2 y 17**
(740) 144

MURAPOL

(210) **542559** (540)
(730) **Diego Hernan Perez Roca**; AR
(220) 16/09/2022
(511) **39 (S/D)**
(740) Av. Roosevelt 2593, Torre TresSesenta, Apto
502, Punta del Este, 20000, Maldonado,
Maldonado, UY

(591) #F5CF00 (amarillo) #323232 (negro)



(210) **542564** (540)
(730) **Allergan Holdings France SAS**; FR
(220) 16/09/2022
(511) **5 (S/D) y 10 (S/D)**
(740) 201

SKINVIVE

(210) **542568** (540)
(730) **Allergan Holdings France SAS**; FR
(220) 16/09/2022
(511) **5 (S/D) y 10 (S/D)**
(740) 201



(210) **542569** (540)
(730) **Kimberly-Clark Worldwide, Inc.;** US
(220) 16/09/2022
(511) **3 (S/D) y 5 (S/D)**
(740) 201

HUGGIES ECO PROTECT

(210) **542572** (540)
(730) **Ernesto Rodrigo DAVIDSOHN BENET;**
AR
(220) 16/09/2022
(511) **19 y 36**
(740) Juan Carlos Gómez 1445 of. 102,
Montevideo, 11400, Montevideo,
Montevideo, UY

RONDPOINT

(210) **542577** (540)
(730) **Gabriel Mendez;** UY
(220) 16/09/2022
(511) **45**
(740) 249

MENDEZ IP

(210) **542578** (540)
(730) **Sharkoon Technologies GmbH**; DE
(220) 16/09/2022
(511) **9 y 20**
(740) 144

SHARKOON

(210) **542579** (540)
(730) **MEGA LABS S.A.**; UY
(220) 16/09/2022
(511) **5**
(740) 144

METROZOL

(210) **542580** (540)
(730) **The Vanguard Group, Inc.**; US
(220) 16/09/2022
(511) **36 y 42**
(740) 136

VANGUARD

(210) **542584** (540)
(730) **MARCIRY S.A;** UY
(220) 16/09/2022
(511) **35 y 36**
(740) 34

WORLD FINANCIAL CENTER MONTEVIDEO

(210) **542585** (540)
(730) **VIDIELLA OHOLEGUY, SOFIA;** UY
(220) 16/09/2022
(511) **36**
(740) 201

(591) ANARANJADO OSCURO, ANARANJADO
CLARO, GRIS Y BLANCO



(210) **542591** (540)
(730) **GONZALO ADRIAN PACHECO**
GASTESI; UY
(220) 16/09/2022
(511) **35 (S/D)**
(740) 212

(591) negro y fucsia



(210) **542592** (540)

(730) **GONZALO ADRIAN PACHECO**
GASTESI; UY

(220) 16/09/2022

(511) **35 (S/D)**

(740) 212

(591) Violeta, negro,

The logo for 'planner' features a purple asterisk above the word 'planner' in a lowercase, sans-serif font.

(210) **542593** (540)

(730) **GONZALO ADRIAN PACHECO**
GASTESI; UY

(220) 16/09/2022

(511) **42 (S/D)**

(740) 212

(591) negro y fucsia

The logo for 'planify' features a pink checkmark above the word 'planify' in a lowercase, sans-serif font.

(210) **542594** (540)

(730) **GONZALO ADRIAN PACHECO**
GASTESI; UY

(220) 16/09/2022

(511) **42 (S/D)**

(740) 212

(591) Violeta, negro

The logo for 'planner' features a purple asterisk above the word 'planner' in a lowercase, sans-serif font.

(210) **542595** (540)
(730) **Pilar Abella Echevarne Antia**; UY
(220) 19/09/2022
(511) **3, 5, 16, 18, 20, 24, 28, 31, 35 y 43**
(740) 129

DELI FOR PETS

(210) **542596** (540)
(730) **Pilar Abella Echevarne Antia**; UY
(220) 19/09/2022
(511) **31, 35 y 43**
(740) 129

LA PANETERA MASCOTERA

(210) **542597** (540)
(730) **RUMPAL COMPANY S.A.**; UY
(220) 19/09/2022
(511) **35 y 36**
(740) 189

CONEXTIA

(210) **542598**
(730) **RUMPAL COMPANY S.A.**; UY
(220) 19/09/2022
(511) **35 y 36**
(740) 189

(540)

CONEXTIA GPI (GESTIÓN PATRIMONIAL INTEGRAL)

(210) **542600**
(730) **MARCELO TOCCHETTO**; UY
(220) 19/09/2022
(511) **25**
(740) CARMELO 1420, MONTEVIDEO, 11700,
MONTEVIDEO, MONTEVIDEO, UY

(540)

TOCHE

(210) **542601**
(730) **INDRAMERICA SAS**; UY
(220) 19/09/2022
(511) **39 y 41**
(740) Bartolome Mitre 1441, Montevideo,
Montevideo, 11600, MONTEVIDEO,
MONTEVIDEO, UY

(540)



Better English. Better Opportunities.

(210) **542603** (540)
(730) **AMBERPLAN S.A.**; UY
(220) 19/09/2022
(511) **16**
(740) 220



(210) **542607** (540)
(730) **L'OREAL**; FR
(220) 19/09/2022
(511) **3 (S/D)**
(740) 144

RÉNERGIE
H.P.N. 300-PEPTIDE CREAM

(210) **542608** (540)
(730) **BAINEPES SA**; UY
(220) 19/09/2022
(511) **16**
(740) 220

(591) Tonos de azul y naranja



(210) **542611** (540)
(730) **SAMSUNG ELECTRONICS CO., LTD.;**
KR
(220) 19/09/2022
(511) **7 (S/D) y 11 (S/D)**
(740) 201

SAMSUNG Infinite Line

(210) **542618** (540)
(730) **Danzelay SA;** UY
(220) 19/09/2022
(511) **43**
(740) 201



(210) **542619** (540)
(730) **Caram, María Inés;** AR
(220) 19/09/2022
(511) **3 (S/D)**
(740) 201

ÉPOCA BELLA

(210) **542621** (540)
(730) **Federico Urquiola**; UY
(220) 19/09/2022
(511) **33**
(740) Cno SAN FUENTES 3225, MONTEVIDEO,
12800, MONTEVIDEO, MONTEVIDEO,
UY



(210) **542623** (540)
(730) **ATRIM ARGENTINA S.A.**; AR
(220) 19/09/2022
(511) **6 y 19**
(740) 201

(591) gris y violeta



(210) **542629** (540)
(730) **Sura Asset Management S.A.**; CO
(220) 19/09/2022
(511) **36 (S/D)**
(740) 94

(591) azul (Pantone HEX 2523F4), negro



(210) **542633** (540)
(730) **Monster Energy Company**; US
(220) 19/09/2022
(511) **30 (S/D)**
(740) 194

JAVA MONSTER

(210) **542634** (540)
(730) **LUZERNE BRANDS LIMITED**; VG
(220) 19/09/2022
(511) **21 (S/D)**
(740) 194

(591) azul, celeste, blanco, verde



(210) **542635** (540)
(730) **Farm Fresh L.L.C**; AE
(220) 19/09/2022
(511) **30 (S/D)**
(740) 34

(591) 0

Sapora

(210) **542636** (540)
(730) **TECSPAL TECHNOLOGIES SAS; UY**
(220) 19/09/2022
(511) **9, 35, 39 y 42**
(740) 212

(591) AZUL, BLANCO



(210) **542637** (540)
(730) **Société des Produits Nestlé S.A.; CH**
(220) 19/09/2022
(511) **5 (S/D)**
(740) 212

OPTI-LAC

(210) **542638** (540)
(730) **Intel Corporation; US**
(220) 19/09/2022
(511) **9 (S/D) y 42 (S/D)**
(740) 245
(300) 86833 27/06/2022 JM

INTEL GETI

(210) **542643** (540)
(730) **STAGNARI MOISE, HECTOR**
MARIANO; UY
(220) 20/09/2022
(511) **33**
(740) 201

PURA SANGRE

(210) **542645** (540)
(730) **NEIRA MONTEMURRO, HÉCTOR; UY**
(220) 20/09/2022
(511) **29 y 30**
(740) 189

RISTORANTTE

(210) **542646** (540)
(730) **Tianjin Fivalco Industrial Co., Ltd.; CN**
(220) 20/09/2022
(511) **6 (S/D)**
(740) 201



(210) **542647** (540)
(730) **Pellistri Rebollo, Facundo y Garcia**
Azzolini, Camila Belen; UY
(220) 20/09/2022
(511) **25 y 35**
(740) 201



(210) **542648** (540)
(730) **BODEGAS Y VIÑEDOS NICOLAS**
CATENA S.A.; AR
(220) 20/09/2022
(511) **33 (S/D)**
(740) 94

CATENA ZAPATA HILL OF BONES

(210) **542653** (540)
(730) **Sinaptrix SRL; UY**
(220) 20/09/2022
(511) **42**
(740) 144

(591) Pantone P 157-16 C, Pantone P 173-16 C



(210) **542654** (540)
(730) **CAMILO CUBA**; UY
(220) 20/09/2022
(511) **35 y 36**
(740) 144

(591) Celeste y Negro



(210) **542661** (540)
(730) **Alejandro Cardozo**; UY
(220) 20/09/2022
(511) **44 (S/D)**
(740) Calle 22, M64, S72 Casa "Magoya" Entre
calle 05 y 07, ATLANTIDA, 15200,
CANELONES, CANELONES, UY

COMUNIDAD CONSCIENTE

(210) **542667** (540)
(730) **Compañía Uruguaya de Transportes
Colectivos Sociedad Anónima
(C.U.T.C.S.A.)**; UY
(220) 20/09/2022
(511) **41**
(740) 94

(591) Azul, celeste, gris, rojo y blanco



(210) **542668** (540)
(730) **Compañía Uruguaya de Transportes
Colectivos Sociedad Anónima
(C.U.T.C.S.A.); UY**
(220) 20/09/2022
(511) **35 y 41**
(740) 94

(591) Azul, celeste, rojo y blanco



(210) **542675** (540)
(730) **SYNGENTA CROP PROTECTION AG;
CH**
(220) 20/09/2022
(511) **1 (S/D) y 5 (S/D)**
(740) 194

ENVIVUS

(210) **542676** (540)
(730) **Valentina Cayota; UY**
(220) 20/09/2022
(511) **41 (S/D)**
(740) Jamaica 3193, Montevideo, 11500,
Montevideo, Montevideo, UY

(591) rgb (104, 160, 181) CMYK (43, 12, 0, 29) +
rgb (251, 252, 252) CMYK (0, 0, 0, 1)



(210) **542677** (540)
(730) **SYNGENTA CROP PROTECTION AG;**
CH
(220) 20/09/2022
(511) **1 (S/D) y 5 (S/D)**
(740) 194

DERANCE

(210) **542678** (540)
(730) **SYNGENTA CROP PROTECTION AG;**
CH
(220) 20/09/2022
(511) **1 (S/D) y 5 (S/D)**
(740) 194

ARTRISIA

(210) **542679** (540)
(730) **SYNGENTA CROP PROTECTION AG;**
CH
(220) 20/09/2022
(511) **1 (S/D) y 5 (S/D)**
(740) 194

VITAFENS

(210) **542680** (540)
(730) **LUZERNE BRANDS LIMITED**; VG
(220) 20/09/2022
(511) **21 (S/D)**
(740) 194

(591) azul, celeste, blanco, verde



(210) **542681** (540)
(730) **FCA US LLC**; US
(220) 20/09/2022
(511) **12 (S/D)**
(740) 194
(300) 97499019 12/07/2022 US



(210) **542690** (540)
(730) **Bruno Rivero**; UY
(220) 21/09/2022
(511) **9 (S/D), 35 (S/D) y 42 (S/D)**
(740) Andes 1409/301, Montevideo, , Montevideo,
Montevideo, UY

(591) Verde, Blanco, Negro



(210) **542691** (540)
(730) **Nintendo of America Inc.**; US
(220) 21/09/2022
(511) **9 (S/D), 18 (S/D), 25 (S/D), 28 (S/D) y 41 (S/D)**
(740) 136

(591) blanco, negro, rojo



(210) **542692** (540)
(730) **Exxon Mobil Corporation**; US
(220) 21/09/2022
(511) **4 (S/D)**
(740) 136

(591) rojo, azul, negro, amarillo



(210) **542696** (540)
(730) **Clariss International Inc.**; US
(220) 21/09/2022
(511) **42 (S/D)**
(740) 245
(300) 97/447.388 07/06/2022 US

CLARIS STUDIO

(210) **542697** (540)
(730) **Daniel Antonio Pietrobon**; AR
(220) 21/09/2022
(511) **7**
(740) 220

(591) Tonos de azul



(210) **542699** (540)
(730) **AUTECO MOBILITY S.A.S.**; CO
(220) 21/09/2022
(511) **12 (S/D)**
(740) 144

(591) Negro Blanco Azul



(210) **542700** (540)
(730) **LATTY INTERNATIONAL S.A.**; FR
(220) 21/09/2022
(511) **6 (S/D) y 17 (S/D)**
(740) 144



(210) **542719**
(730) **Claris International Inc.**; US
(220) 21/09/2022
(511) **9 (S/D)**
(740) 245
(300) 97/447.405 07/06/2022 US

(540)

CLARIS PRO

(210) **542724**
(730) **ALICORP S.A.A**; PE
(220) 21/09/2022
(511) **3 (S/D)**
(740) 212

(540)

PELU QUERIDA

(210) **542726**
(730) **ALICORP S.A.A**; PE
(220) 21/09/2022
(511) **3 (S/D)**
(740) 212

(540)



(210) **542727** (540)
(730) **ALICORP S.A.A;** PE
(220) 21/09/2022
(511) **5 (S/D)**
(740) 212

PELU QUERIDA

(210) **542729** (540)
(730) **ALICORP S.A.A;** PE
(220) 21/09/2022
(511) **5 (S/D)**
(740) 212



(210) **542730** (540)
(730) **ALICORP S.A.A;** PE
(220) 21/09/2022
(511) **3 (S/D)**
(740) 212

REPARACIÓN DIVINA

(210) **542731**
(730) **ALICORP S.A.A**; UY
(220) 21/09/2022
(511) **3 (S/D)**
(740) 212

(540)



(210) **542732**
(730) **ALICORP S.A.A**; PE
(220) 21/09/2022
(511) **5 (S/D)**
(740) 212

(540)

REPARACIÓN DIVINA

(210) **542733**
(730) **ALICORP S.A.A**; UY
(220) 21/09/2022
(511) **5 (S/D)**
(740) 212

(540)



(210) **542734** (540)
(730) **ALICORP S.A.A**; PE
(220) 21/09/2022
(511) **3 (S/D)**
(740) 212

BENDITO CLIMA DE LIMA

(210) **542735** (540)
(730) **ALICORP S.A.A**; UY
(220) 21/09/2022
(511) **3 (S/D)**
(740) 212

FRESCURA QUE DURA

(210) **542736** (540)
(730) **ALICORP S.A.A**; PE
(220) 21/09/2022
(511) **5 (S/D)**
(740) 212

BENDITO CLIMA DE LIMA

(210) **542737**
(730) **ALICORP S.A.A**; UY
(220) 21/09/2022
(511) **5 (S/D)**
(740) 212

(540)

FRESCURA QUE DURA

(210) **542738**
(730) **ALICORP S.A.A**; PE
(220) 21/09/2022
(511) **3 (S/D)**
(740) 212

(540)

DIOSA RULOSA

(210) **542739**
(730) **ALICORP S.A.A**; PE
(220) 21/09/2022
(511) **3 (S/D)**
(740) 212

(540)

MAGIA ANDINA

(210) **542740** (540)
(730) **RSI IP Holding, LLC**; US
(220) 21/09/2022
(511) **9 (S/D), 28 (S/D) y 41 (S/D)**
(740) 34
(300) 97407228 12/05/2022 US

RUSHBET

(210) **542741** (540)
(730) **URUFARMA S.A.**; UY
(220) 21/09/2022
(511) **5**
(740) 34

NOVIDAT

(210) **542742** (540)
(730) **ALICORP S.A.A**; PE
(220) 21/09/2022
(511) **5 (S/D)**
(740) 212

DIOSA RULOSA

(210) **542744**
(730) **ALICORP S.A.A**; PE
(220) 21/09/2022
(511) **5 (S/D)**
(740) 212

(540)

MAGIA ANDINA

(210) **542745**
(730) **A.A. DE ALMEIDA EQUIPAMENTOS**
AGROINDUSTRIAL LTDA.; BR
(220) 21/09/2022
(511) **7 (S/D) y 35 (S/D)**
(740) 34

(540)

ALMEIDA EQUIPAMENTOS

(210) **542746**
(730) **LENADY S.A.**; UY
(220) 21/09/2022
(511) **36 (S/D) y 42 (S/D)**
(740) 34

(540)

(591) 0



(210) **542747** (540)
(730) **LENADY S.A.**; UY
(220) 21/09/2022
(511) **36 (S/D) y 42 (S/D)**
(740) 34

(591) PMS 7426, PMS 7635, PMS 205, PMS 7424,
PMS 212, PMS 211



(210) **542749** (540)
(730) **Apple Inc.**; US
(220) 21/09/2022
(511) **9 (S/D) y 14 (S/D)**
(740) 245
(300) 2022-371 25/05/2022 LI

APPLE WATCH ULTRA

(210) **542757** (540)
(730) **Jaime Tobal**; UY
(220) 22/09/2022
(511) **25 y 35**
(740) inclusa 184, Montevideo, , Montevideo,
Montevideo, UY

VAN HALEN

(210) **542760** (540)
(730) **Andrés Piriz**; UY
(220) 22/09/2022
(511) **41 (S/D)**
(740) Avenida General Rivera 3131 apto 603,
Montevideo, 11600, Montevideo,
Montevideo, UY

(591) #31C344, #474749



(210) **542761** (540)
(730) **Florencia Fischetti**; UY
(220) 22/09/2022
(511) **25 (S/D)**
(740) Jackson 1425, montevideo, , montevideo,
montevideo, UY

FLORALIA

(210) **542764** (540)
(730) **EUROPEAN COSMETICS LIMITADA**;
UY
(220) 22/09/2022
(511) **43**
(740) 168

(591) PANTONE 871C - PANTONE 1795C -
PANTONE YELLOW C - PANTONE 422 C
- PANTONE 7541 C - NEGRO



(210) **542765** (540)
(730) **LATTY INTERNATIONAL S.A.**; FR
(220) 22/09/2022
(511) **6 (S/D) y 17 (S/D)**
(740) 144

(591) PANTONE COOL GRAY 9 C, PANTONE
109 C



(210) **542774** (540)
(730) **Florencia Sica**; UY
(220) 22/09/2022
(511) **25**
(740) Marco Bruto 1332, Pocitos, , Montevideo,
Montevideo, UY

(591) BLANCO Y NEGRO



(210) **542775** (540)
(730) **Dufry International AG (Dufry
International SA) (Dufry International
Ltd)**; CH
(220) 22/09/2022
(511) **33 (S/D)**
(740) 218

Lote Oculto

(210) **542777**
(730) **Vitabiotics Ltd; GB**
(220) 22/09/2022
(511) **5 (S/D)**
(740) 136

(540)

NEUROMIND

(210) **542785**
(730) **MARIA SILVIA MATO GARCIA; UY**
(220) 22/09/2022
(511) **10 y 25**
(740) 218

(540)

(591) rosa, amarillo y tonos de verde

The logo for 'Alisma' features the brand name in a light green, cursive script. To the right of the text, there is a small graphic of three stylized flowers in shades of pink and red.

(210) **542794**
(730) **SHOWA DENKO K.K.; JP**
(220) 22/09/2022
(511) **1 (S/D), 2 (S/D), 3 (S/D), 4 (S/D), 6 (S/D), 7 (S/D), 9 (S/D), 11 (S/D), 12 (S/D), 16 (S/D), 17 (S/D), 19 (S/D), 21 (S/D), 37 (S/D), 40 (S/D) y 42 (S/D)**
(740) 34

(540)

CHEMISTRY FOR CHANGE

(210) **542795** (540)
(730) **TVLX Viagens e Turismo S.A.**; BR
(220) 22/09/2022
(511) **39 (S/D)**
(740) 34

(591) 0



(210) **542796** (540)
(730) **Citizen Watch Company of America, Inc.**
d/b/a Bulova; US
(220) 22/09/2022
(511) **14 (S/D)**
(740) 34

BULOVA OCULUS

(210) **542797** (540)
(730) **Cash S.A.**; UY
(220) 22/09/2022
(511) **41**
(740) 34

(591) BLANCO, NEGRO, PANTONE VERDE
375, PANTONE BLUE 072



(210) **542798**
(730) **Claris International Inc.**; US
(220) 22/09/2022
(511) **9 (S/D) y 42 (S/D)**
(740) 245
(300) 86989 18/07/2022 JM

(540)

CLARIS WEBDIRECT

(210) **542799**
(730) **Claris International Inc.**; US
(220) 22/09/2022
(511) **9 (S/D)**
(740) 245
(300) 86983 18/07/2022 JM

(540)

CLARIS GO

(210) **542801**
(730) **Claris International Inc.**; US
(220) 22/09/2022
(511) **9 (S/D)**
(740) 245
(300) 86982 18/07/2022 JM

(540)

CLARIS SERVER

(210) **542802** (540)
(730) **Clarís International Inc.;** US
(220) 22/09/2022
(511) **42 (S/D)**
(740) 245

CLARIS CONNECT

(210) **542804** (540)
(730) **TABACOS VENUS INDUSTRIA E**
COMERCIO LTDA.; BR
(220) 22/09/2022
(511) **34 (S/D)**
(740) 163

(591) No reivindica colores

The logo for 'BE HAPPY' features the words 'BE' and 'HAPPY' in a bold, sans-serif font. The letters are white with a thick black outline, giving them a 3D, blocky appearance. The words are positioned side-by-side.

(210) **542805** (540)
(730) **TABACOS VENUS INDUSTRIA E**
COMERCIO LTDA.; BR
(220) 22/09/2022
(511) **34 (S/D)**
(740) 163

(591) No reivindica colores

The logo for 'D'ora' features the word 'D'ora' in a stylized, cursive script font. The letters are white with a thick black outline, giving them a 3D, bubbly appearance. The 'D' is particularly large and prominent.

(210) **542806** (540)

(730) **facundo solveyra**; AR

(220) 22/09/2022

(511) **19 (S/D)**

(740) Dr. Eduardo Irastorza 1037, Carmelo, 70100,
Colonia, Colonia, UY

(591) NEGRO



SANTORINI

(210) **542808** (540)

(730) **LUIS ALBERTO GONZALEZ PINTOS**;
UY

(220) 23/09/2022

(511) **30 y 43**

(740) 247

CASA ALONSO

(210) **542809** (540)

(730) **AGL ELETRONICOS DO BRASIL S/A**;
BR

(220) 23/09/2022

(511) **7, 9 y 35**

(740) 168

(591) BLANCO - NEGRO - AMARILLO



AGL
Soluções em segurança eletrônica.

(210) **542812** (540)
(730) **CARBAJALES, ALFONSO**; UY
(220) 23/09/2022
(511) **9**
(740) 201

PANORAMA

(210) **542813** (540)
(730) **Yiwu Ackiliss Electric Co., Ltd.**; CN
(220) 23/09/2022
(511) **11 (S/D)**
(740) 144

RAF

(210) **542814** (540)
(730) **DXMAX BRASIL LTDA**; BR
(220) 23/09/2022
(511) **17 (S/D) y 35 (S/D)**
(740) 212

DXMAX

(210) **542815** (540)

(730) **Carlos Alvarez**; UY

(220) 23/09/2022

(511) **41**

(740) LUIS GALVANI 4655, Montevideo, ,
Montevideo, Montevideo, UY

(591) BLANCO Y NEGRO



MOVIMIENTO ESPÍRITA

(210) **542817** (540)

(730) **Cámara Inmobiliaria Punta del Este**
Maldonado; UY

(220) 23/09/2022

(511) **36**

(740) 201

(591) azul, negro, turquesa claro y turquesa oscuro



(210) **542819** (540)

(730) **DOMINGO R. GHELFA**; UY

(220) 23/09/2022

(511) **29, 30 y 31**

(740) 144

(591) Blanco, Negro, Pantone 1505 C



(210) **542824** (540)
(730) **VRIO CORP.**; US
(220) 23/09/2022
(511) **35 (S/D), 38 (S/D) y 41 (S/D)**
(740) 218

(591) blanco, Pantone 281 C



(210) **542825** (540)
(730) **ESTANCIA SANTA MANUELA S.A.**; UY
(220) 23/09/2022
(511) **33**
(740) 201

ANDALUZ

(210) **542826** (540)
(730) **COLGATE-PALMOLIVE COMPANY**;
US
(220) 23/09/2022
(511) **3 (S/D)**
(740) 201



(210) **542827** (540)
(730) **Carolina Cruzat**; CL
(220) 23/09/2022
(511) **25 (S/D)**
(740) Dr. Alejandro Schroeder 6475, montevideo, ,
montevideo, montevideo, UY
(300) 1251896 21/04/2017 CL

MALVA

(210) **542828** (540)
(730) **VRIO CORP.**; US
(220) 23/09/2022
(511) **35 (S/D), 38 (S/D) y 41 (S/D)**
(740) 218

(591) blanco, Pantone 281 C



(210) **542829** (540)
(730) **COLGATE-PALMOLIVE COMPANY**;
US
(220) 23/09/2022
(511) **3 (S/D)**
(740) 201



(210) **542830** (540)
(730) **Martin Larrosa Sequeira;** UY
(220) 23/09/2022
(511) **44**
(740) 220



(210) **542831** (540)
(730) **COLGATE-PALMOLIVE COMPANY;**
US
(220) 23/09/2022
(511) **3 (S/D)**
(740) 201



(210) **542832** (540)
(730) **Intel Corporation;** US
(220) 23/09/2022
(511) **9 (S/D) y 42 (S/D)**
(740) 245
(300) 86184 04/04/2022 JM

INTEL BLOCKSCALE

(210) **542838** (540)
(730) **HENDERSON & CIA. S.A.**; UY
(220) 23/09/2022
(511) **35 y 36**
(740) 181

(591) Blanco, Pantone 2728 C, Pantone 032 C



(210) **542839** (540)
(730) **HENDERSON & CIA. S.A.**; UY
(220) 23/09/2022
(511) **35 y 36**
(740) 181



(210) **542841** (540)
(730) **HENDERSON & CIA. S.A.**; UY
(220) 23/09/2022
(511) **35 y 36**
(740) 181

(591) Blanco, Pantone 2728 C, Pantone 032 C



(210) **542842** (540)
(730) **HENDERSON & CIA. S.A.; UY**
(220) 23/09/2022
(511) **35 y 36**
(740) 181

(591) No reivindica colores.



(210) **542845** (540)
(730) **ANTONIO BASSO & FILHOS LTDA; BR**
(220) 23/09/2022
(511) **33 (S/D)**
(740) 168

(591) BLANCO – NEGRO – DORADO - ROJO



(210) **542847** (540)
(730) **YIWU AIDO TRADING CO., LTD.; CN**
(220) 23/09/2022
(511) **9 (S/D)**
(740) 34

(591) 0

EZRA

(210) **542850** (540)
(730) **BIOMA INDUSTRIA COMERCIO E
DISTRIBUICAO-EIRELI; BR**
(220) 23/09/2022
(511) **35 (S/D)**
(740) 163

(591) No reivindica colores



Bioma

(210) **542851** (540)
(730) **GO EXPER PARTICIPACOES LTDA.;**
BR
(220) 23/09/2022
(511) **35 (S/D)**
(740) 163

(591) No reivindica colores



Gexper

(210) **542852** (540)
(730) **MO & PC COLLECTIONS URUGUAY
SRL; UY**
(220) 23/09/2022
(511) **35 y 36**
(740) 181

(591) Azul claro y azul oscuro



MO&PC
URUGUAY

(210) **542853** (540)
(730) **CZ Vaccines, S.A.U.**; ES
(220) 23/09/2022
(511) **42 (S/D)**
(740) 216

(591) azul

ZENDAL

(210) **542855** (540)
(730) **BIAGRO COMERCIO E
DISTRIBUICAO DE INSUMOS
AGROPECUARIOS LTDA.**; BR
(220) 23/09/2022
(511) **35 (S/D)**
(740) 163

(591) No reivindica colores



BIAGRO

(210) **542856** (540)
(730) **JingAo Solar Co., Ltd**; CN
(220) 23/09/2022
(511) **9 (S/D)**
(740) 216

(591) Blanco y negro

JASOLAR

(210) **542858** (540)
(730) **BRANDSTORY, S.L.**; ES
(220) 23/09/2022
(511) **31 (S/D) y 35 (S/D)**
(740) 216

(591) Blanco y negro

The logo for 'Plet' features the word 'Plet' in a bold, black, sans-serif font. A thick horizontal line is positioned directly beneath the letters.

(210) **542859** (540)
(730) **SIMBIOSE INDÚSTRIA E COMÉRCIO
DE FERTILIZANTES E INSUMOS
MICROBIOLÓGICOS LTDA.**; BR
(220) 23/09/2022
(511) **5 (S/D)**
(740) 163

(591) No reivindica colores

The logo for 'FlyControl Simbiose' consists of a stylized wing icon to the left of the text 'FlyControl' in a bold, sans-serif font. Below 'FlyControl', the word 'Simbiose' is written in a smaller, lighter font.

(210) **542860** (540)
(730) **SIMBIOSE INDÚSTRIA E COMÉRCIO
DE FERTILIZANTES E INSUMOS
MICROBIOLÓGICOS LTDA.**; BR
(220) 23/09/2022
(511) **5 (S/D)**
(740) 163

(591) No reivindica colores

The logo for 'STIMUControl' features a stylized wing icon to the left of the text 'STIMUControl' in a bold, sans-serif font.

(210) **542861** (540)
(730) **SIMBIOSE INDÚSTRIA E COMÉRCIO
DE FERTILIZANTES E INSUMOS
MICROBIOLÓGICOS LTDA.;** BR
(220) 23/09/2022
(511) **1 (S/D)**
(740) 163

(591) No reivindica colores



(210) **542862** (540)
(730) **SIMBIOSE INDÚSTRIA E COMÉRCIO
DE FERTILIZANTES E INSUMOS
MICROBIOLÓGICOS LTDA.;** BR
(220) 23/09/2022
(511) **5 (S/D)**
(740) 163

(591) No reivindica colores



(210) **542863** (540)
(730) **SIMBIOSE INDÚSTRIA E COMÉRCIO
DE FERTILIZANTES E INSUMOS
MICROBIOLÓGICOS LTDA.;** BR
(220) 23/09/2022
(511) **35 (S/D)**
(740) 163

(591) No reivindica colores



(210) **542864**
(730) **VANALIM S.A.**; UY
(220) 23/09/2022
(511) **14, 18, 25 y 35**
(740) 245

(540)

SOUL
street**market**

(210) **542866**
(730) **UMBERTO S.R.L.**; UY
(220) 26/09/2022
(511) **29 y 30**
(740) 201

(540)

**Príncipe
Humberto**

(210) **542869**
(730) **CIMA, FEDERICO**; AR
(220) 26/09/2022
(511) **9 (S/D)**
(740) 189

(540)

(591) Negro, blanco, verde

CANNECT
INDOOR FUTURE

(210) **542879** (540)
(730) **GONZALEZ GROSSI, LUIS
FERNANDO**; UY
(220) 26/09/2022
(511) **36**
(740) 201

(591) ROJO, NEGRO Y BLANCO



(210) **542880** (540)
(730) **Midea Group Co., Ltd.**; CN
(220) 26/09/2022
(511) **11 (S/D)**
(740) 201



(210) **542881** (540)
(730) **VIGLIARA S.A.**; UY
(220) 26/09/2022
(511) **43**
(740) 201

(591) BLANCO, MARRON, GRIS, VERDE,
ROJO Y NEGRO



(210) **542893** (540)
(730) **Lubrifilm Group SAS**; UY
(220) 26/09/2022
(511) **1 (S/D)**
(740) Bulevar Artigas 2709 Apto 107, Montevideo,
 , Montevideo, Montevideo, UY

LUBRIFILM

(210) **542898** (540)
(730) **SYNGENTA CROP PROTECTION AG**;
 CH
(220) 26/09/2022
(511) **1 (S/D) y 5 (S/D)**
(740) 194

SUBLINZA

(210) **542899** (540)
(730) **SYNGENTA CROP PROTECTION AG**;
 CH
(220) 26/09/2022
(511) **1 (S/D) y 5 (S/D)**
(740) 194

ANAPRIA

(210) **542900** (540)
(730) **SYNGENTA CROP PROTECTION AG;**
CH
(220) 26/09/2022
(511) **1 (S/D) y 5 (S/D)**
(740) 194

CONSINIA

(210) **542901** (540)
(730) **SYNGENTA CROP PROTECTION AG;**
CH
(220) 26/09/2022
(511) **1 (S/D) y 5 (S/D)**
(740) 194

EQIBRE

(210) **542902** (540)
(730) **URUFARMA S.A.;** UY
(220) 26/09/2022
(511) **5**
(740) 34

PERCICLIB

(210) **542903**

(540)

(730) **JUAN DOMINGO LEIVA; AR**

(220) 26/09/2022

(511) **35**

(740) 212

(210) **542904**

(540)

(730) **JUAN DOMINGO LEIVA; AR**

(220) 26/09/2022

(511) **36**

(740) 212

(210) **542905**

(540)

(730) **Cecilia Peri; UY**

(220) 26/09/2022

(511) **43**

(740) 212

(210) **542906** (540)
(730) **JUAN DOMINGO LEIVA**; AR
(220) 26/09/2022
(511) **14**
(740) 212

The logo for 'Leiva' is written in a stylized, cursive script font. The letters are dark blue or black, with a slight shadow or outline effect, giving it a three-dimensional appearance. The 'L' is particularly large and elegant.

(210) **542908** (540)
(730) **FORTYLEX S.A.**; UY
(220) 26/09/2022
(511) **30**
(740) 245

(591) ROJO

ELITE

(210) **542919** (540)
(730) **PAGINAS AMARILLAS S.A.S.**; UY
(220) 27/09/2022
(511) **35 y 38**
(740) 104

ENCUENTRE YA

(210) **542921** (540)
(730) **PAGINAS AMARILLAS S.A.S.**; UY
(220) 27/09/2022
(511) **16, 35 y 38**
(740) 104

PAGINAS CLASIFICADAS

(210) **542923** (540)
(730) **Carpintería Metálica Orlando**; AR
(220) 27/09/2022
(511) **6 y 37**
(740) 154

(591) Verde, verde marino, verde oscuro marino y
verde agua



(210) **542925** (540)
(730) **Brum Costa Abogados S.A.S.**; UY
(220) 27/09/2022
(511) **35, 41, 42 y 45**
(740) 144

BRUM COSTA

(210) **542926** (540)
(730) **JAVIER ALEJANDRO DUARTE LÓPEZ**
y EMILIO RAFAEL NICOLA BATISTA;
UY
(220) 27/09/2022
(511) **9 y 42**
(740) Gutierrez Ruiz 1103 apto 601, Montevideo, ,
Montevideo, Montevideo, UY

(591) celeste, blanco, azul, gris



(210) **542942** (540)
(730) **JOSE LUIS GOMEZ;** UY
(220) 27/09/2022
(511) **7**
(740) RUTA 107 KM 8, SAUCE, 90800,
CANELONES, CANELONES, UY



(210) **542943** (540)
(730) **Robert Correa;** UY
(220) 27/09/2022
(511) **41**
(740) LAMAS, BRIG. GRAL DIEGO 935, Artigas,
, Artigas, Artigas, UY

(591) Blanco, celeste y negro



(210) **542952** (540)
(730) **Productora y Comercializadora**
Odontológica New Stetic S.A.; CO
(220) 27/09/2022
(511) **5 (S/D)**
(740) 216

ZAFIRA LIGHT CURING COMPOSITE

(210) **542967** (540)
(730) **Panificadora Bimbo del Uruguay S.A.; UY**
(220) 28/09/2022
(511) **30**
(740) 181

(591) Blanco, negro, Pantone 2192 C y Pantone 871
C



(210) **542981** (540)
(730) **Johnson & Johnson; US**
(220) 28/09/2022
(511) **3 (S/D), 5 (S/D), 9 (S/D), 10 (S/D), 21 (S/D),**
35 (S/D), 41 (S/D), 42 (S/D) y 44 (S/D)
(740) 94
(300) 86526 17/05/2022 JM

KENVUE

(210) **542982** (540)
(730) **Johnson & Johnson**; US
(220) 28/09/2022
(511) **3 (S/D), 5 (S/D), 9 (S/D), 10 (S/D), 21 (S/D),
35 (S/D), 41 (S/D), 42 (S/D) y 44 (S/D)**
(740) 94
(300) 87385 01/09/2022 JM
(591) No reivindica colores

The logo for Kenvue, featuring a stylized 'K' icon followed by the word 'kenvue' in a lowercase, sans-serif font.

(210) **542992** (540)
(730) **Mateo Miraglia**; AR
(220) 28/09/2022
(511) **30 (S/D)**
(740) 144

The logo for Arrabal, consisting of the word 'ARRABAL' in a bold, uppercase, serif font.

(210) **542994** (540)
(730) **ZODIAC INTERNATIONAL
CORPORATION**; PA
(220) 28/09/2022
(511) **5**
(740) 245

(591) Rojo y negro

The logo for Tecta, featuring a stylized 'T' icon followed by the word 'TECTA' in a bold, uppercase, sans-serif font.

(210) **542995** (540)
(730) **CYTEC TECHNOLOGY CORP.; US**
(220) 28/09/2022
(511) **1 (S/D)**
(740) 179

AEROSOL

(210) **542997** (540)
(730) **ZODIAC INTERNATIONAL
CORPORATION; PA**
(220) 28/09/2022
(511) **5**
(740) 245



(210) **543001** (540)
(730) **ZODIAC INTERNATIONAL
CORPORATION; PA**
(220) 28/09/2022
(511) **5**
(740) 245

(591) Rojo y negro



(210) **543005** (540)

(730) **ZODIAC INTERNATIONAL
CORPORATION; PA**

(220) 28/09/2022

(511) **5**

(740) 245

(591) Rojo y negro



(210) **543007** (540)

(730) **ZODIAC INTERNATIONAL
CORPORATION; PA**

(220) 28/09/2022

(511) **5**

(740) 245

(591) Rojo y negro



(210) **543010** (540)

(730) **ZODIAC INTERNATIONAL
CORPORATION; PA**

(220) 28/09/2022

(511) **5**

(740) 245

(591) Rojo y negro



(210) **543018** (540)

(730) **ZODIAC INTERNATIONAL CORPORATION; PA**

(220) 28/09/2022

(511) **5**

(740) 245

(591) Rojo y negro



(210) **543025** (540)

(730) **Panificadora Bimbo del Uruguay S.A.; UY**

(220) 28/09/2022

(511) **30**

(740) 181

(591) No reivindica colores.



(210) **543030** (540)

(730) **Brum Costa Abogados S.A.S.; UY**

(220) 28/09/2022

(511) **35, 41, 42 y 45**

(740) 144

(591) Pantone 547 C, Pantone 7620 C



(210) **543031** (540)
(730) **Jorge Martin Gelezoglo Cazzuli y
Geronimo Lisboa; BR**
(220) 28/09/2022
(511) **29 (S/D)**
(740) 220

(591) TONOS DE ROJO, AMARILLO y CELETE



(210) **543047** (540)
(730) **BRISANIER S.A.; UY**
(220) 29/09/2022
(511) **35, 36 y 42**
(740) 201

(591) R:14,G:42;B:79 #OE2A4F -
R:24,G:144,B:255 #1890FF



(210) **543049** (540)
(730) **BANCO DE LA REPÚBLICA ORIENTAL
DEL URUGUAY; UY**
(220) 29/09/2022
(511) **36**
(740) 154

(591) Amarillo, azul y blanco.



(210) **543058** (540)
(730) **Linde GmbH**; DE
(220) 29/09/2022
(511) **9 (S/D)**
(740) 192

(591) AZUL, CELESTE, BLANCO.



(210) **543059** (540)
(730) **Astier de Villatte**; FR
(220) 29/09/2022
(511) **3 (S/D), 4 (S/D), 8 (S/D), 11 (S/D), 16 (S/D)**
y **21 (S/D)**
(740) 192

ASTIER DE VILLATTE

(210) **543065** (540)
(730) **MICHELENA MASSIOTTI, CAROLINA**;
UY
(220) 29/09/2022
(511) **10**
(740) 245

EVALUNA

(210) **543067** (540)
(730) **BANCO BILBAO VIZCAYA**
ARGENTARIA, S.A.; ES
(220) 29/09/2022
(511) **36 (S/D)**
(740) 245

BQIS

(210) **543070** (540)
(730) **Treck S.A;** CL
(220) 29/09/2022
(511) **9 (S/D)**
(740) 245

TRECK

(210) **543072** (540)
(730) **ASTEROL S.A.;** UY
(220) 29/09/2022
(511) **39**
(740) 34

SOUTH AMERICA INCOMING

(210) **543073**
(730) **Treck S.A;** CL
(220) 29/09/2022
(511) **9 (S/D)**
(740) 245

(540)

ACTIVEX

(210) **543074**
(730) **Treck S.A;** CL
(220) 29/09/2022
(511) **9 (S/D)**
(740) 245

(540)

VFLEX

(210) **543075**
(730) **Treck S.A;** CL
(220) 29/09/2022
(511) **9 (S/D)**
(740) 245

(540)

ABSOLUTE ZERO

(210) **543076**
(730) **Treck S.A.**; CL
(220) 29/09/2022
(511) **9 (S/D)**
(740) 245

(540)

ABSOLUTE FIRE

SOLICITUDES DE FRASES PUBLICITARIAS

(210) **541683**
(730) **Cronos Climatizaciones SRL .;** UY
(220) 24/08/2022
(511) **7 (S/D), 8 (S/D), 11 (S/D) y 35 (S/D)**
(740) Comodoro Coe 3970, Buceo, 11400,
Montevideo, Montevideo, UY
(300) 12345 23/08/2022 UY

(540)

EXPERTOS EN MÁQUINAS Y HERRAMIENTAS

(210) **542181**
(730) **MINEVALL S.A.;** UY
(220) 07/09/2022
(511) **35**
(740) Blanes Viale 35, Colonia del Sacramento,
70000, Colonia, Colonia, UY

(540)

EXPERTOS EN DESCANSO

(210) **542237** (540)
(730) **MINEVALL S.A.**; UY
(220) 08/09/2022
(511) **35**
(740) Blanes Viale 35, Colonia del Sacramento,
70000, Colonia, Colonia, UY

TU CASA MÁS CÓMODA

(210) **542482** (540)
(730) **COOPERATIVA NACIONAL DE
PRODUCTORES DE LECHE
(CONAPROLE)**; UY
(220) 14/09/2022
(511) **29**
(740) 194

(591) Azul: Pantone Reflex Blue; Verde: Pantone
368; celeste: Pantone 299; blanco



(210) **542743** (540)
(730) **FA Maringa LTDA**; BR
(220) 21/09/2022
(511) **20**
(740) 34

DORMIR BIEN PARA VIVIR MEJOR

(210) **542752**
(730) **FERNELS S.A.**; UY
(220) 22/09/2022
(511) **7, 12 y 35**
(740) 129

(540)

**HACELO FÁCIL, HACELO
CON EQUUS**

(210) **542753**
(730) **FERNELS S.A.**; UY
(220) 22/09/2022
(511) **7, 12 y 35**
(740) 129

(540)

SU BRAZO MÁS FUERTE

(210) **542818**
(730) **PepsiCo, Inc.**; US
(220) 23/09/2022
(511) **29**
(740) 201

(540)

NO LAY'S NO GAME

(210) **542822**
(730) **PEPSICO, INC.;** US
(220) 23/09/2022
(511) **29**
(740) 201

(540)

SIN LAY'S NO HAY PARTIDO

RESOLUCIONES DE MARCAS, CONCEDIDAS

N° Exp	Resolución	Marca	Clases	Titular	Ag.
472080	02/09/2022	NOCHE DE LOS FOGONES	41 (Concedida)	INTENDENCIA DEPARTAMENTAL DE LAVALLEJA	212
472081	02/09/2022	SEMANA DE LAVALLEJA	41 (Concedida)	INTENDENCIA DEPARTAMENTAL DE LAVALLEJA	212
477050	30/09/2022	IZZE (mixta)	32 (Concedida S/D)	PORTFOLIO CONCENTRATE SOLUTIONS UNLIMITED COMPANY	201
478299	05/09/2022	GUUAO	35 (Concedida S/D)	GUUAO, C.A.	212
482794	09/09/2022	(figurativa)	12 (Concedida S/D)	KYB Corporation	34
482795	05/09/2022	(figurativa)	12 (Concedida S/D)	KYB Corporation	34
482901	08/09/2022	EXIMIA	2 (Concedida)	PREPAN S.A.	220
483206	08/09/2022	OY OFERTA YA (mixta)	39 (Concedida), 38 (Concedida), 37 (Concedida), 36 (Concedida) y 35 (Concedida)	FERNANDO JAVIER CABALLERO DE LUIS	
484168	08/09/2022	VIEJO URBAN (mixta)	35 (Concedida) y 25 (Concedida)	ALVARO ZALCMAN	
484845	19/09/2022	TOSTOP	5 (Concedida)	SAVANT PHARM S.A.	144
486273	16/09/2022	BRIT	31 (Concedida S/D)	MATIAS FERNANDEZ DE MARCO	160
486500	09/09/2022	Q QUANTUM (mixta)	9 (Concedida S/D)	BOREO COMÉRCIO DE EQUIPAMENTOS LTDA.	212
486700	16/09/2022	PANCHOS EXTRA CENTENARIO (mixta)	29 (Concedida)	FRIGORIFICO CENTENARIO S.A.	179
486701	16/09/2022	PANCHOS ARIZONA	29 (Concedida)	FRIGORIFICO CENTENARIO S.A.	179
488080	14/09/2022	ZEO (mixta)	31 (Concedida S/D), 5 (Concedida S/D) y 1 (Denegada S/D)	GIANNI S.A.	192
488259	02/09/2022	UVFA UNION OF VIRTUAL FOOTBALL ASSOCIATIONS	42 (Concedida), 41 (Concedida), 35	BANCA DE CUBIERTA COLECTIVA DE QUINIELAS DE MONTEVIDEO	18

N° Exp	Resolución	Marca	Clases	Titular	Ag.
		ESPORTS 2017 (mixta)	(Concedida), 28 (Concedida), 25 (Concedida), 16 (Concedida) y 9 (Concedida)		
488754	02/09/2022	DEDICAR (mixta)	45 (Concedida S/D) y 39 (Concedida)	GONZALO FABIAN GARCIA CONSTENLA y MARIELA LETICIA ABETTO ORTIZ	192
489071	28/09/2022	ECO BOLA	38 (Concedida), 35 (Concedida) y 21 (Concedida)	EDALSIR SOCIEDAD ANONIMA	
489072	02/09/2022	COMPRALO YA	38 (Concedida) y 35 (Concedida)	EDALSIR SOCIEDAD ANONIMA	
489406	08/09/2022	ENJOY VACATIONS (mixta)	43 (Concedida) y 41 (Concedida)	ENJOY GESTIÓN LIMITADA	94
490646	26/09/2022	BOHEMIA CRYSTAL (mixta)	21 (Concedida)	Crystalex CZ, s.r.o.	101
491183	02/09/2022	M FM METROPOLITANA (mixta)	41 (Concedida S/D) y 38 (Concedida S/D)	MARCOS BLÁS FAINGOLD	233
491862	30/09/2022	CITI WELCOME WHAT'S NEXT (mixta)	36 (Concedida S/D) y 35 (Concedida S/D)	CITIGROUP INC.	194
491863	30/09/2022	CITI WELCOME WHAT'S NEXT	36 (Concedida S/D) y 35 (Concedida S/D)	CITIGROUP INC.	194
492943	30/09/2022	TUENVIOYA (mixta)	39 (Concedida), 38 (Concedida) y 35 (Concedida)	JOSE IGNACIO SAAVEDRA	
493671	09/09/2022	JOYSON SAFETY SYSTEMS	24 (Concedida S/D), 12 (Concedida S/D) y 9 (Concedida S/D)	JOYSON AUTO SAFETY S.A	34
495711	30/09/2022	SUPER OUTLET (mixta)	35 (Concedida)	FORTER SOCIEDAD ANONIMA	189

N° Exp	Resolución	Marca	Clases	Titular	Ag.
495954	07/09/2022	MALA FAMA (mixta)	43 (Concedida) y 32 (Concedida)	Buena Birra S.R.L.	18
496039	16/09/2022	VEOCEL (mixta)	27 (Concedida), 25 (Concedida), 24 (Concedida), 23 (Concedida), 22 (Concedida), 21 (Concedida), 20 (Concedida), 17 (Concedida), 16 (Concedida), 10 (Concedida), 9 (Concedida), 5 (Concedida) y 3 (Concedida)	Lenzing Aktiengesellschaft	94
496064	19/09/2022	CIELO (mixta)	25 (Concedida)	ETOILE SRL	
496394	28/09/2022	(figurativa)	9 (Concedida S/D)	SHARK	192
496693	14/09/2022	ATH A TODA HORA (mixta)	36 (Concedida S/D)	EVERTEC Group, LLC	194
497408	07/09/2022	X-TENDED DEFENSE	3 (Concedida S/D)	JOHNSON & JOHNSON	194
497547	21/09/2022	AIWA (mixta)	11 (Concedida)	AUDIO MOBILE AMERICAS, S.A.	212
498960	19/09/2022	DIDPA	5 (Concedida)	MEGALABS URUGUAY S.A.	144
500762	16/09/2022	JSS (mixta)	42 (Concedida S/D), 24 (Concedida S/D), 12 (Concedida S/D) y 9 (Concedida S/D)	JOYSON AUTO SAFETY S.A.	34
501767	07/09/2022	ARTICO (mixta)	43 (Concedida) y 29 (Concedida)	DANILO CORDONE	165
502105	28/09/2022	TRIPLERENZ	5 (Concedida S/D)	NOVARTIS AG.	201
502117	30/09/2022	DISNEAL MEGALABS	5 (Concedida)	Mega Labs S.A.	144
502166	30/09/2022	MYSTIQUE	43 (Concedida)	LADANI S.A.	201
502167	09/09/2022	PROTECTUS (mixta)	45 (Concedida)	WIFE	163

N° Exp	Resolución	Marca	Clases	Titular	Ag.
502431	08/09/2022	ZONA FRANCA PARQUE DE LAS CIENCIAS (mixta)	35 (Concedida)	Parque de las Ciencias S.A	144
502441	08/09/2022	PARQUE DE LAS CIENCIAS FREE ZONE (mixta)	35 (Concedida)	Parque de las Ciencias S.A	144
502449	08/09/2022	ZONA FRANCA PARQUE DE LAS CIENCIAS (mixta)	35 (Concedida)	Parque de las Ciencias S.A	144
502955	02/09/2022	(figurativa)	42 (Concedida S/D), 39 (Concedida S/D), 38 (Concedida S/D) y 9 (Concedida S/D)	HERE Global B.V.	18
503524	19/09/2022	CHACABUCO SINCE 1939 (mixta)	33 (Concedida)	AITOR IDER BALBO SAACI	94
503554	07/09/2022	EXTRA OTTONELLO	31 (Concedida), 30 (Concedida) y 29 (Concedida)	OTTONELLO HNOS. S.A.	194
503861	02/09/2022	23% PROTEINAS CARNES Y CEREALES MIX PERROS ADULTOS MORDIDA PEQUEÑA SABROSITOS TU MASCOTA SABE...PRODUCTO CON CALIDAD METRIVE (mixta)	31 (Concedida)	METRIVE S.A.	189
503953	07/09/2022	ARYART (mixta)	37 (Concedida S/D), 21 (Concedida), 20 (Concedida), 19 (Concedida), 11 (Concedida) y 6 (Concedida)	ARYART SA	245
504308	07/09/2022	LUBILAX	5 (Concedida)	MEGALABS URUGUAY S.A.	144
504332	30/09/2022	ICON DESIGN (mixta)	41 (Concedida S/D), 16 (Concedida S/D) y 9 (Denegada S/D)	MONDADORI MEDIA SPA	194
504414	02/09/2022	HEATWAVE	11 (Concedida S/D)	Conair LLC	136
504604	02/09/2022	OPTI-FERT	5 (Concedida S/D)	Société des Produits Nestlé S.A.	156

N° Exp	Resolución	Marca	Clases	Titular	Ag.
504785	02/09/2022	BRASERO	11 (Concedida S/D)	DEVANET S.A.	201
504948	07/09/2022	EL PUESTIN (mixta)	43 (Concedida) y 35 (Concedida)	Martin Alemán Pereira y Santiago Andrés Alemán Pereira	101
505160	30/09/2022	BLUE RIVER (mixta)	34 (Concedida S/D) y 5 (Concedida)	Blue River of California LLC	216
505341	19/09/2022	TRACKERS	25 (Concedida)	JOSE LUIS DE CUNTO	
505426	30/09/2022	LORENA CAPRILE (mixta)	35 (Concedida), 25 (Concedida) y 18 (Concedida)	LORENA SILVEIRA CAPRILE	194
505430	16/09/2022	DELI (mixta)	43 (Concedida) y 30 (Concedida)	Pablo Fedorchuk	212
505468	02/09/2022	RIZLA PRECISION	34 (Concedida S/D)	Imperial Tobacco Intellectual Property Limited	136
507901	09/09/2022	(figurativa)	43 (Concedida), 35 (Concedida) y 32 (Concedida)	MONTES DEL URUGUAY SRL	
507964	09/09/2022	NORD (mixta)	34 (Concedida S/D)	SHENZHEN IVPS TECHNOLOGY CO.,LTD.	34
508256	09/09/2022	CORNERSTONE BUILDING BRANDS	41 (Concedida S/D), 37 (Concedida S/D), 36 (Concedida S/D), 35 (Concedida S/D), 20 (Concedida S/D), 19 (Concedida S/D), 18 (Concedida S/D), 11 (Concedida S/D) y 6 (Concedida S/D)	NCI Group, Inc.	212
508485	30/09/2022	GESTALT VIVA	41 (Concedida) y 16 (Concedida)	GABRIELA PALMA CAORSI	101
508804	02/09/2022	EL ABROJAL	44 (Concedida), 36 (Concedida), 35 (Concedida) y 31 (Concedida)	GUSTAVO ALBERTO DI FORTUNA VIQUE	101

N° Exp	Resolución	Marca	Clases	Titular	Ag.
508870	02/09/2022	UPPERCUT DELUXE	3 (Concedida S/D)	Uppercut Deluxe Pty Ltd	94
508872	02/09/2022	UPPERCUT DELUXE (mixta)	3 (Concedida S/D)	Uppercut Deluxe Pty Ltd	94
509665	19/09/2022	COGNIZANT	42 (Concedida) y 35 (Concedida)	Cognizant Technology Solutions U.S. Corporation	201
509923	30/09/2022	RIVERA BRILLA EN DICIEMBRE. (mixta)	41 (Concedida)	Intendencia Departamental de Rivera	144
509937	30/09/2022	TOP (mixta)	26 (Concedida), 21 (Concedida), 20 (Concedida) y 8 (Concedida)	COBOE S.A.	212
510535	06/09/2022	(figurativa)	34 (Concedida S/D)	Shanghai Tobacco Group Co., Ltd.	144
511922	30/09/2022	G CONTROLGAS (mixta)	11 (Concedida) y 9 (Concedida)	HUGO OMAR ARDID TORRES	220
511931	20/09/2022	STERIFLUID	5 (Concedida)	SOUTHLAND WATERS CORP	220
512899	02/09/2022	GENESIS (mixta)	18 (Concedida S/D) y 14 (Concedida S/D)	Hyundai Motor Company	201
514247	02/09/2022	VIBRALINE	37 (Concedida S/D) y 17 (Concedida S/D)	Prismo Road Markings Limited	194
514996	09/09/2022	QUÉ LE REGALO (mixta)	42 (Concedida S/D)	Valentina Morelli; Natalia Soledad Diaz Diaz y Patricia Ripoll Gleizer	
515762	02/09/2022	BNI+ (mixta)	41 (Concedida S/D) y 35 (Concedida S/D)	BNI GLOBAL, LLC	34
516512	09/09/2022	NA77I	41 (Concedida S/D)	Natalia Ferrero	193
516638	02/09/2022	CRECIMIENTO VERDE (mixta)	11 (Concedida) y 1 (Concedida)	Nicolas Garcia Badani	
516705	15/09/2022	SUSTRATO INSUMOS CULTIVADOR SOLUCIONES PARA TU JARDIN PROFESIONAL (mixta)	1 (Concedida S/D)	INSUMOS CULTIVADOR SRL	

N° Exp	Resolución	Marca	Clases	Titular	Ag.
517444	15/09/2022	FF (mixta)	35 (Concedida), 24 (Concedida) y 20 (Concedida)	Fendi s.r.l.	212
517479	09/09/2022	AGUARÁ BEER HOUSE (mixta)	32 (Concedida S/D)	PEREZ MIÑAN DIEGO GABRIEL Y MONTANDON PICON GONZALO JOSE SOCIEDAD DE HECHO	
517493	02/09/2022	INSUMOS CULTIVADOR (mixta)	35 (Concedida S/D), 34 (Concedida S/D), 31 (Concedida S/D), 5 (Concedida S/D) y 1 (Concedida S/D)	INSUMOS CULTIVADOR SRL	
517760	09/09/2022	TMG (mixta)	31 (Concedida S/D)	TMG TROPICAL MELHORAMENTO E GENÉTICA S.A.	34
517894	09/09/2022	PERFOR (mixta)	9 (Concedida S/D) y 7 (Concedida S/D)	PERFOR INDÚSTRIAS DE MÁQUINAS LTDA.- EPP	212
518597	09/09/2022	FAZENDA FUTURO	30 (Concedida S/D) y 29 (Concedida S/D)	Fazenda Futuro Produtos Alimenticios SA	194
518600	02/09/2022	DR. LEMON	33 (Concedida) y 32 (Concedida)	SPEED PUBLICIDAD S.A.C.I.F.	34
518633	02/09/2022	ISLA CLERICÓ (mixta)	33 (Concedida)	CEPAS ARGENTINAS S.A.	34
518635	02/09/2022	ISLA SANGRÍA (mixta)	33 (Concedida)	CEPAS ARGENTINAS S.A.	34
519299	09/09/2022	OBVIUS	31 (Concedida S/D), 5 (Concedida S/D) y 1 (Concedida S/D)	BASF SE	165
519419	02/09/2022	DE LA COLONIA	33 (Concedida)	SENFOR S.A.	201
519499	02/09/2022	BOLZILLO (mixta)	36 (Concedida S/D) y 9 (Concedida S/D)	SERGIO GUSTAVO MURA VELÁZQUEZ	144
519559	21/09/2022	EARLYFEED (mixta)	31 (Concedida S/D) y 5 (Concedida S/D)	NUSCIENCE BELGIUM N.V.	216
519672	26/09/2022	EL ESTABLO (mixta)	25 (Concedida S/D)	Ignacio Ferreyra	

N° Exp	Resolución	Marca	Clases	Titular	Ag.
519943	02/09/2022	CANELONES TE ALIMENTA (mixta)	41 (Concedida), 38 (Concedida), 35 (Concedida), 32 (Concedida), 31 (Concedida), 30 (Concedida) y 29 (Concedida)	INTENDENCIA MUNICIPAL DE CANELONES	220
519957	02/09/2022	ACTION	31 (Concedida)	GRUPO PILAR S.A.	34
519983	21/09/2022	FINDOUT SOLUCIONES DE CONSULTORÍA (mixta)	35 (Concedida S/D)	Adela Rodriguea Arrillaga	
520050	30/09/2022	5 HISPANOS - KRACHITOS SNACKS	30 (Concedida)	LOS CINCO HISPANOS S.A.	34
520106	09/09/2022	LA PODEROSA (mixta)	44 (Concedida) y 31 (Concedida)	EBATEL S.A.	201
520189	15/09/2022	NUTERRA NUTRICIÓN DESDE LA TIERRA (mixta)	41 (Concedida S/D), 31 (Concedida S/D) y 30 (Concedida S/D)	DE LA COSTA AGROPECUARIAS SAS	
520304	30/09/2022	GREEN HOPE TIENDA DE ALIMENTOS SALUDABLES (mixta)	32 (Concedida), 30 (Concedida) y 29 (Concedida)	MARIA JOSE RAMOS CASTRO	
520332	15/09/2022	HERBONÍS INDEPENDENT BY NATURE (mixta)	31 (Concedida) y 5 (Concedida)	Herbonis AG	201
520333	09/09/2022	HERBONIS	31 (Concedida) y 5 (Concedida)	Herbonis AG	201
520334	09/09/2022	PANBONIS	31 (Concedida) y 5 (Concedida)	Herbonis AG	201
520634	09/09/2022	MUJERES DE MINAS DE CORRALES (mixta)	31 (Concedida)	Elda Patricia Leguisamón Madruga; Hibaina Yovana Pirez Alvez y Sonia Mabel Santestevan Leal	212
520897	19/09/2022	BREED SPIRIT DOGFOOD (mixta)	31 (Concedida S/D)	GRUPO PILAR S.A.	34
521013	02/09/2022	CDDS CENTRO DE DESARROLLO	41 (Concedida S/D)	Luis Alberto Caseres Orcoyen	

N° Exp	Resolución	Marca	Clases	Titular	Ag.
		DEL DEPORTE Y LA SALUD (mixta)			
521025	02/09/2022	CARABELAS	33 (Concedida)	NAFIREY S.A.	219
521059	02/09/2022	IRACEMA	31 (Concedida) y 30 (Concedida)	Iracema Industria e Comercio de Castanhas de Caju Ltda.	
521063	02/09/2022	TRULY	33 (Concedida S/D)	Boston Beer Corporation	136
521082	02/09/2022	SC SANATORIO COMERI (mixta)	44 (Concedida S/D)	Potencia Inc. SAS	
521175	09/09/2022	FAWNA (mixta)	31 (Concedida S/D)	AGRO INDUSTRIAS BAIRES S.A.	34
521190	09/09/2022	FAS	31 (Concedida)	Forestal Atlántico Sur	
521191	09/09/2022	LOGMA	31 (Concedida S/D)	Logística Maderera S.A.	
521192	15/09/2022	LOGÍSTICA MADERERA	31 (Concedida)	Logística Maderera	
521203	30/09/2022	SISU - ACOMPAÑAMIENTO EDUCATIVO Y LABORAL (mixta)	41 (Concedida S/D)	Pilar Akiki	
521252	09/09/2022	GOLETA	33 (Concedida)	SENFOR S.A.	201
521276	09/09/2022	OJO DE TIGRE	33 (Concedida S/D)	MEZCAL OJO DE TIGRE, S.A.P.I. DE C.V.	94
521281	30/09/2022	CÁRNICO (mixta)	29 (Concedida S/D)	SANTA CLARA S.R.L.	94
521392	02/09/2022	HAPPY HENS (mixta)	29 (Concedida)	ALBIÑANA GOMENSORO, JUAN	201
521466	26/09/2022	TREMENDO (mixta)	33 (Concedida S/D)	LIBROSOL S.A	
521545	09/09/2022	VIMA FOODS (mixta)	31 (Concedida S/D), 30 (Concedida S/D) y 29 (Concedida S/D)	VIMA WORLD SA	144
521847	09/09/2022	GM (mixta)	45 (Concedida S/D), 42 (Concedida S/D), 41 (Concedida S/D), 40 (Concedida S/D), 39 (Concedida S/D), 38 (Concedida S/D), 37 (Concedida S/D), 36 (Concedida S/D), 35 (Concedida S/D), 34 (Concedida S/D),	GENERAL MOTORS LLC	136

N° Exp	Resolución	Marca	Clases	Titular	Ag.
			28 (Concedida S/D), 27 (Concedida S/D), 26 (Concedida S/D), 25 (Concedida S/D), 24 (Concedida S/D), 22 (Concedida S/D), 21 (Concedida S/D), 20 (Concedida S/D), 18 (Concedida S/D), 17 (Concedida S/D), 16 (Concedida S/D), 14 (Concedida S/D), 12 (Concedida S/D), 11 (Concedida S/D), 9 (Concedida S/D), 8 (Concedida S/D), 7 (Concedida S/D), 6 (Concedida S/D), 4 (Concedida S/D), 3 (Concedida S/D), 2 (Concedida S/D) y 1 (Concedida S/D)		
521939	09/09/2022	VIDPREVTYN	5 (Concedida S/D)	SANOFI PASTEUR INC.	165
521940	09/09/2022	VYDNECT	5 (Concedida S/D)	SANOFI PASTEUR INC.	165
521941	09/09/2022	VULTECVID	5 (Concedida S/D)	SANOFI PASTEUR INC.	165
521943	09/09/2022	REMEXAL	5 (Concedida)	LABORATORIO GADOR S.A.	165
521944	09/09/2022	(figurativa)	12 (Concedida S/D)	SHANGHAI PHOENIX ENTERPRISE (GROUP) CO., LTD.	201
521945	09/09/2022	EMRANVID	5 (Concedida S/D)	SANOFI PASTEUR INC.	165
521946	21/09/2022	PAXMYRNA	5 (Concedida S/D)	SANOFI PASTEUR INC.	165
521947	21/09/2022	VIDMAREVE	5 (Concedida S/D)	SANOFI PASTEUR INC.	165

N° Exp	Resolución	Marca	Clases	Titular	Ag.
522005	09/09/2022	GLORIA (mixta)	29 (Concedida)	GLORIA S.A.	144
522006	09/09/2022	GLORIA (mixta)	30 (Concedida)	GLORIA S.A.	144
522008	09/09/2022	GLORIA (mixta)	32 (Concedida)	GLORIA S.A.	144
522079	20/09/2022	INVENERGY	42 (Concedida S/D), 41 (Concedida S/D), 40 (Concedida S/D), 39 (Concedida S/D), 37 (Concedida S/D), 36 (Concedida S/D) y 35 (Concedida S/D)	Invenergy LLC	94
522269	19/09/2022	ENSTO (mixta)	9 (Concedida)	Ensto Oy	201
522295	02/09/2022	EXPERIENCIAS GARZÓN	43 (Concedida S/D) y 35 (Concedida)	AGROLAND S.A.	216
522389	02/09/2022	VETERINARIA ALEM PET SHOP (mixta)	44 (Concedida S/D) y 5 (Concedida S/D)	IGNACIO MARCELO MEGLIOLI	19
522433	09/09/2022	THE GARZÓN SCHOOL DISCERE CUM GAUDIO (mixta)	41 (Concedida S/D)	VARELA, BRUNO	201
522447	02/09/2022	BRISTOT (mixta)	43 (Concedida S/D) y 30 (Concedida S/D)	Procaffè S.p.A.	34
522457	26/09/2022	LEITZA	33 (Concedida)	jorge urquiola machin	
522468	09/09/2022	META CONSULTORÍA GASTRONÓMICA	35 (Concedida S/D)	Alvaro Javier Russi Ranguis	
522470	02/09/2022	VITTA PILATES (mixta)	41 (Concedida S/D)	Erica Olivera	
522487	02/09/2022	LA PUERTA DE AL LADO (mixta)	42 (Concedida)	ARTAGAVEYTIA GARCIA, INES MARIA Y BOSCH PEREZ DEL CASTILLO, VERONICA MARIA (sociedad de hecho)	34
522488	02/09/2022	CERCODIL - CINTA CUBRE CERCOS (mixta)	35 (Concedida) y 22 (Concedida S/D)	DIL S.A	
522521	05/09/2022	OLMOS	37 (Concedida), 17	ZALWIN S.A.	201

N° Exp	Resolución	Marca	Clases	Titular	Ag.
			(Concedida), 16 (Concedida) y 1 (Concedida)		
522623	26/09/2022	LAS CANDELAS	33 (Concedida)	ANALIA MARCELA FUENTES	
522670	02/09/2022	ZYNYZ Z (mixta)	44 (Concedida S/D) y 5 (Concedida S/D)	Incyte Holdings Corporation	212
522699	26/09/2022	MARIA DEL HUERTO URUGUAY HECHO CON AMOR (mixta)	33 (Concedida) y 30 (Concedida)	Unipersonal Miler Minetti Pablo German	172
522743	05/09/2022	BEAUTY CAPS (mixta)	5 (Concedida)	SÁEZ MARTIRENA LUCÍA BEATRIZ	212
522763	19/09/2022	WONASPORTS	9 (Concedida S/D)	CALATIS SOCIEDAD ANÓNIMA	189
522829	19/09/2022	R (mixta)	41 (Concedida S/D), 35 (Concedida S/D), 29 (Concedida S/D), 10 (Concedida S/D), 5 (Concedida S/D) y 3 (Concedida S/D)	Reckitt & Colman (Overseas) Health Limited	144
522843	19/09/2022	CORTAG (mixta)	8 (Concedida S/D)	CORTAG INDÚSTRIA E COMÉRCIO LTDA	144
522855	19/09/2022	54D	41 (Concedida S/D) y 35 (Concedida S/D)	CARDIO MONSTER USA, LLC.	245
522856	02/09/2022	BLEM LIMPIEZA DIARIA	3 (Concedida S/D)	S. C. JOHNSON & SON, INC.	194
522857	19/09/2022	KMTTOOLS (mixta)	8 (Concedida S/D) y 6 (Concedida)	XIA YONGPING	144
522858	02/09/2022	KMTSTYLE (mixta)	28 (Concedida)	XIA YONGPING	144
522859	02/09/2022	KMTSTYLE (mixta)	27 (Concedida)	XIA YONGPING	144
522860	02/09/2022	KMTSTYLE (mixta)	21 (Concedida)	XIA YONGPING	144
522861	02/09/2022	KMT	16 (Concedida)	XIA YONGPING	144
522862	02/09/2022	XIME TORRES (mixta)	43 (Concedida) y 30 (Concedida)	Chocolatier SRL	232
522864	02/09/2022	LA DULCERÍA XIME TORRES (mixta)	43 (Concedida) y 30 (Concedida)	Chocolatier SRL	232

N° Exp	Resolución	Marca	Clases	Titular	Ag.
522865	02/09/2022	CNILE KINLU (mixta)	25 (Concedida S/D)	Zhang Wendu	245
522866	02/09/2022	SECUREPAY (mixta)	42 (Concedida) y 36 (Concedida)	Banque Heritage (Uruguay) S.A.	94
522867	02/09/2022	SICHERT	42 (Concedida S/D), 17 (Concedida S/D), 9 (Concedida S/D) y 6 (Concedida S/D)	Berthold Sichert GmbH	94
522868	05/09/2022	BEQUBOND	5 (Concedida S/D)	Principia Biopharma Inc.	144
522869	02/09/2022	BRILZEOND	5 (Concedida S/D)	Principia Biopharma Inc.	144
522870	02/09/2022	BION3 (mixta)	5 (Concedida S/D)	P&G Health Germany GmbH	212
522880	02/09/2022	MARKETPLAY	39 (Concedida)	ALBERTO MARTIN SCASSO VOLONTE	
522881	19/09/2022	SXTR R SPORTXTREME (mixta)	35 (Concedida S/D) y 25 (Concedida S/D)	CLAUDIA VANRELL	
522883	02/09/2022	G FORCE	28 (Concedida)	INDUTECH SOCIEDAD ANÓNIMA	189
522887	05/09/2022	LANAS DEL URUGUAY (mixta)	25 (Concedida) y 23 (Concedida S/D)	MANOS DEL URUGUAY ASOCIACIÓN CIVIL	220
522888	05/09/2022	GORDON URUGUAY PEDAGOGÍA MUSICAL (mixta)	41 (Concedida)	SECCO, FLORENCIA	201
522890	02/09/2022	BIPROL	5 (Concedida)	BALIARDA S.A.	201
522891	02/09/2022	Á (mixta)	35 (Concedida) y 14 (Concedida)	María Agustina González García	
522894	02/09/2022	EQUIND EQUIPOS INDUSTRIALES UNA EMPRESA A SU SERVICIO (mixta)	37 (Concedida), 9 (Concedida) y 7 (Concedida)	Gerardo Montes de Oca	
522898	02/09/2022	CMC (mixta)	35 (Concedida)	Felipe Sanguinetti	
522917	05/09/2022	SUMO SLICER	21 (Concedida S/D) y 11 (Concedida)	INTERMARK LTDA.	201
522952	02/09/2022	KKERLY EXCITING DRINK (mixta)	32 (Concedida S/D)	KK8 S.R.L.	201
522968	26/09/2022	THEIA	33 (Concedida S/D), 32 (Concedida S/D),	SCOBY SRL	

N° Exp	Resolución	Marca	Clases	Titular	Ag.
			30 (Concedida S/D) y 29 (Concedida S/D)		
522974	26/09/2022	THEIA ATELIER DE INFUSIONES ESTD 2017 (mixta)	33 (Concedida S/D), 32 (Concedida S/D), 30 (Concedida S/D) y 29 (Concedida S/D)	SCOPY SRL	
522999	26/09/2022	MAKER'S MARK S IV (mixta)	33 (Concedida S/D)	MAKER'S MARK DISTILLERY, INC	194
523040	30/09/2022	PENNY FARTHING URUGUAY (mixta)	12 (Concedida S/D)	Alejandro Saravia	
523110	02/09/2022	(figurativa)	45 (Concedida S/D), 42 (Concedida S/D), 41 (Concedida S/D), 39 (Concedida S/D), 38 (Concedida S/D), 37 (Concedida S/D), 35 (Concedida S/D), 9 (Concedida S/D) y 6 (Concedida S/D)	SECURITAS AB	192
523129	02/09/2022	M MELANIA (mixta)	25 (Concedida)	Gerardo Belfer	
523174	27/09/2022	DEWAR'S DOUBLE AGENT	33 (Concedida S/D)	BACARDI & COMPANY LIMITED	194
523206	09/09/2022	RED HORSE (mixta)	32 (Concedida S/D)	San Miguel Brewing International Limited.	205
523224	05/09/2022	FORMULA BEAUTY (mixta)	35 (Concedida) y 3 (Concedida)	AGUSTIN BRUNO; IVANNA VALENTINA VINAJA PASCUAL y GIANNINA RINALDI	34
523270	30/09/2022	FAMILIA INSTITUCIONAL (mixta)	37 (Concedida S/D)	PRODUCTOS FAMILIA S.A.	144
523278	21/09/2022	(figurativa)	35 (Concedida), 28 (Concedida), 20 (Concedida) y 9 (Concedida S/D)	Acer Incorporated	181
523329	26/09/2022	FREIXENET MIA	33 (Concedida S/D)	FREIXENET, S.A.	144

N° Exp	Resolución	Marca	Clases	Titular	Ag.
			y 32 (Concedida S/D)		
523336	26/09/2022	QUIEROVINO	41 (Concedida), 35 (Concedida) y 33 (Concedida)	DE AMBROGGI, ANTONELLA	189
523341	27/09/2022	PINK MASK (mixta)	3 (Concedida S/D)	PINK MASK USA LLC	201
523358	06/09/2022	PSICONUTRIENDO	44 (Concedida S/D) y 41 (Concedida S/D)	CARDOZO BASTOS DEBORAH ELIZABETH Y ARIAS PICON LUZ ANDREINA SOCIEDAD DE HECHO	
523473	19/09/2022	ARENAS DE VIDRIO (mixta)	40 (Concedida), 21 (Concedida) y 19 (Concedida S/D)	DEMARIA SUAREZ ANA PAULA UNIPERSONAL	220
523519	20/09/2022	MY PPERY (mixta)	35 (Concedida S/D)	ASTERIOL S.A.	201
523546	26/09/2022	BUCHETTA (mixta)	33 (Concedida)	Fernando Pettenuzzo	216
523575	13/09/2022	CUBIQ	42 (Concedida S/D), 41 (Concedida S/D) y 9 (Concedida S/D)	FINNING INTERNATIONAL INC.	212
523576	13/09/2022	CUBIQ (mixta)	42 (Concedida S/D), 41 (Concedida S/D) y 9 (Concedida S/D)	FINNING INTERNATIONAL INC.	212
523602	30/09/2022	TWILIO	42 (Concedida S/D), 38 (Concedida S/D) y 9 (Concedida S/D)	Twilio Inc. A Delaware USA corporation	216
523604	21/09/2022	(figurativa)	42 (Concedida S/D), 38 (Concedida S/D) y 9 (Concedida S/D)	Twilio Inc. A Delaware USA corporation	216
523635	02/09/2022	MICLEARING (mixta)	36 (Concedida) y 35 (Concedida)	EQUIFAX URUGUAY S.A.	194
523643	02/09/2022	CHAU PANTALLAS (mixta)	28 (Concedida)	CHAU PANTALLAS S.R.L.	194
523644	02/09/2022	SOLO MIO (mixta)	28 (Concedida)	CHAU PANTALLAS S.R.L.	194
523646	02/09/2022	CHAR LAS DE MESA (mixta)	28 (Concedida)	CHAU PANTALLAS S.R.L.	194

N° Exp	Resolución	Marca	Clases	Titular	Ag.
523647	02/09/2022	LA CHOCOLATERÍA (mixta)	35 (Concedida) y 30 (Concedida)	Luis Eduardo Puglisi Giuliano	212
523659	02/09/2022	AIRTAG	18 (Concedida) y 14 (Concedida)	APPLE INC.	245
523662	02/09/2022	OCUCOAT	5 (Concedida S/D)	Bausch + Lomb Ireland Limited	212
523666	26/09/2022	HATSU	33 (Concedida S/D)	POSTOBON S.A.	181
523669	02/09/2022	REPROVITA LAB & BIOBANK (mixta)	44 (Concedida)	Reprovita S.A.S	244
523671	02/09/2022	AIWA (mixta)	12 (Concedida)	AUDIO MOBILE AMERICAS, S.A.	212
523674	02/09/2022	PTA ECOPRINT (mixta)	17 (Concedida)	ARQUIFOAM S.A.	189
523676	02/09/2022	AMOITÉ MÁS ALLA DE LO VISIBLE (mixta)	3 (Concedida)	ROS CASTRO, EDELMA MARIA	201
523678	02/09/2022	FRESCOSUR	39 (Concedida S/D) y 35 (Concedida S/D)	Bruno Buchelli Andres; Helen Alexandra Quintero De Nobrega y Conrado Ezequiel Quiroga Gomez	
523679	02/09/2022	DESTINO SPA & ESTÉTICA (mixta)	44 (Concedida S/D)	Juan Francisco Tabárez Orlandi	
523680	02/09/2022	SP SIMPLEMENTE - AUTHENTIC PILATES - URUGUAY - 2021 (mixta)	41 (Concedida)	CORCELET GIUSINI SILVIA GRACIELA	179
523682	02/09/2022	CUIDADOS ONLINE TU SALUD A UN CLIC (mixta)	45 (Concedida), 44 (Concedida) y 35 (Concedida)	CUIDADOS ONLINE S.A.S.	
523715	06/09/2022	BOLETERÍANET LOW COST TICKETS (mixta)	41 (Concedida)	LOPEZ POUY, GABRIEL ANDRES	201
523717	06/09/2022	ARAVAN LABS (mixta)	42 (Concedida)	ARAVANLABS SRL	212
523718	02/09/2022	AMBAR (mixta)	16 (Concedida)	Juan Pablo Genta y Tatiana Leone	220
523719	06/09/2022	ALPHA	34 (Concedida)	COMPAÑIA INDUSTRIAL DE TABACOS MONTE-PAZ S.A.	245
523720	02/09/2022	TEZSPIRE	5 (Concedida S/D)	Amgen Inc.	245
523721	02/09/2022	LA CROIX (mixta)	44 (Concedida)	Penino Monje Lizet Eliane	245
523722	06/09/2022	CLUB GANADERO URUGUAY (mixta)	36 (Concedida) y 35 (Concedida)	VILLA GALA GROUP SRL	34

N° Exp	Resolución	Marca	Clases	Titular	Ag.
523726	05/09/2022	SAIF (mixta)	3 (Concedida)	CALILIS S.A.	245
523730	07/09/2022	DON DANTE	43 (Concedida) y 30 (Concedida)	María Elvira Fratta Silvera	
523731	02/09/2022	VALDURA	5 (Concedida S/D)	KCI Manufacturing Unlimited Company	194
523732	06/09/2022	GOGREEN (mixta)	12 (Concedida)	DIGITAL WORLD SRL	212
523734	06/09/2022	GREENED TECHOS VERDES (mixta)	44 (Concedida), 37 (Concedida) y 19 (Concedida)	DAGHERO PEREZ MARCELO GABRIEL	212
523735	05/09/2022	(figurativa)	39 (Concedida S/D), 38 (Concedida S/D), 37 (Concedida S/D), 36 (Concedida S/D), 35 (Concedida S/D), 12 (Concedida S/D) y 4 (Concedida S/D)	RENAULT S.A.S.	181
523737	02/09/2022	APARSO (mixta)	25 (Concedida S/D)	APARSO (FUJIAN) SPORTSWEAR CO., LTD.	220
523738	02/09/2022	(figurativa)	25 (Concedida S/D)	APARSO (FUJIAN) SPORTSWEAR CO., LTD.	220
523740	02/09/2022	ROCKRIDER	12 (Concedida)	DECELESTE S.A.	189
523743	16/09/2022	INGLES SILVER WWW.INGLESSILVER.ORG (mixta)	41 (Concedida S/D)	Silvia Graciela Straffurini Silva	
523746	02/09/2022	HIKMICRO	42 (Concedida S/D) y 9 (Concedida S/D)	Hangzhou Hikmicro Sensing Technology Co., Ltd.	212
523752	02/09/2022	(figurativa)	42 (Concedida S/D) y 9 (Concedida S/D)	Hangzhou Hikmicro Sensing Technology Co., Ltd.	212
523758	06/09/2022	AGROSANDU	35 (Concedida)	AGROSANDU SRL	223
523761	06/09/2022	FURTIVA	25 (Concedida)	GODIAL S.R.L.	201
523768	06/09/2022	NITROX MOTORCYCLE PARTS R (mixta)	12 (Concedida S/D)	AUTECO MOBILITY S.A.S.	144
523783	06/09/2022	CARABELE (mixta)	43 (Concedida)	RAQUET SOUTO CAROLINA MARIA, VIVO CASAROTTI BERNARDO JOSE Y OTROS SOCIEDAD DE HECHO	194

N° Exp	Resolución	Marca	Clases	Titular	Ag.
523790	05/09/2022	A (mixta)	41 (Concedida) y 35 (Concedida)	MEDALLA RIVAS, EVA MARIA	201
523795	06/09/2022	IVY THOMAS PRE-SCHOOL (mixta)	41 (Concedida)	Ana Borrás y Mercedes Borrás	216
523798	07/09/2022	IVY THOMAS MEMORIAL SCHOOL FIDES ET SAPIENTIA OMNIA VINCUNT (mixta)	41 (Concedida)	Ana Borrás y Mercedes Borrás	216
523815	09/09/2022	ECOTECH-LA NUEVA TECNOLOGÍA EN AIRE ACONDICIONADO (mixta)	11 (Concedida S/D)	BRUNO GIANI BISIO Y RODRIGO CHAVES SOLSONA	223
523834	07/09/2022	PARA-GENIOL	5 (Concedida)	URUFARMA S.A.	34
523836	07/09/2022	NOVOGENIOL	5 (Concedida)	URUFARMA S.A.	34
523838	07/09/2022	GENIOL INFANTIL	5 (Concedida)	URUFARMA S.A.	34
523839	07/09/2022	GENIOLITO	5 (Concedida)	URUFARMA S.A.	34
523841	26/09/2022	COLORE BIBI GRAETZ (mixta)	33 (Concedida S/D)	Bibi Graetz di Dan Graetz	245
523842	26/09/2022	BIBI GRAETZ	33 (Concedida S/D)	Bibi Graetz di Dan Graetz	245
523852	26/09/2022	DOS HOMBRES	33 (Concedida S/D)	Dos Hombres, LLC	212
523853	26/09/2022	DOS HOMBRES (mixta)	33 (Concedida S/D)	Dos Hombres, LLC	212
523856	09/09/2022	SPORTECH- CÉSPED SINTÉTICO-ILUMINACIÓN LED (mixta)	27 (Concedida S/D) y 11 (Concedida S/D)	BRUNO GIANI BISIO Y RODRIGO CHAVES SOLSONA	223
523868	26/09/2022	JIM BEAM	33 (Concedida S/D)	JIM BEAM BRANDS CO.	194
523874	12/09/2022	MYBEEF3 (mixta)	40 (Concedida), 35 (Concedida), 30 (Concedida), 29 (Concedida S/D) y 18 (Concedida)	MINERVA S.A.	94
523883	09/09/2022	CASA FLOR HOTEL BOUTIQUE MONTOYA (mixta)	43 (Concedida S/D)	Valchor S.R.L.	154
523899	21/09/2022	SSAB BY ITECH SMART SOFTWARE APPLIED TO BUSINESS (mixta)	42 (Concedida), 35 (Concedida) y 9 (Concedida S/D)	ITECH COM SAS	186
523904	26/09/2022	NAVE ROBINO	33 (Concedida S/D)	Bodega Dante Robino S.A.	144

N° Exp	Resolución	Marca	Clases	Titular	Ag.
523985	13/09/2022	CLINICA ODONTOLÓGICA WHITE	44 (Concedida S/D)	Gabriel Alexander Melgarejo Masui	
524000	02/09/2022	L'OREAL COLOR RICHE	3 (Concedida S/D)	L'OREAL	144
524016	02/09/2022	ABUELA ITA LA QUIERO (mixta)	30 (Concedida S/D)	Cupana S.R.L.	245
524019	02/09/2022	INTERADEX	5 (Concedida)	FEMADIL S.A.	201
524020	30/09/2022	INTERACOM	5 (Concedida)	FEMADIL S.A.	201
524029	02/09/2022	LINK SHOCK (mixta)	28 (Concedida S/D) y 9 (Concedida S/D)	ZITRO INTERNATIONAL S. à r.l.	220
524035	02/09/2022	EL NUEVO GAUCHO (mixta)	29 (Concedida)	EL NUEVO GAUCHO SRL	220
524036	02/09/2022	LIVE GREATNESS	35 (Concedida)	Hard Rock Limited	
524038	02/09/2022	MIELES DE RIVERA (mixta)	30 (Concedida S/D)	INTENDENCIA MUNICIPAL DE RIVERA	144
524045	09/09/2022	CHEESUS	43 (Concedida S/D) y 35 (Concedida S/D)	Delivery Hero HF Kitchens GmbH	144
524046	02/09/2022	GANGNAM KITCHEN	43 (Concedida S/D) y 35 (Concedida S/D)	Delivery Hero HF Kitchens GmbH	144
524047	02/09/2022	MAMACITA	43 (Concedida S/D) y 35 (Concedida S/D)	Delivery Hero HF Kitchens GmbH	144
524050	02/09/2022	(figurativa)	42 (Concedida S/D) y 9 (Concedida S/D)	SHIMANO INC.	94
524051	02/09/2022	(figurativa)	42 (Concedida S/D) y 9 (Concedida S/D)	SHIMANO INC.	94
524052	02/09/2022	(figurativa)	42 (Concedida S/D) y 9 (Concedida S/D)	SHIMANO INC.	94
524055	02/09/2022	MAPLE	37 (Concedida S/D) y 12 (Concedida S/D)	ZHEJIANG GEELY HOLDING GROUP CO., LTD.	34
524058	02/09/2022	(figurativa)	37 (Concedida S/D) y 12 (Concedida S/D)	ZHEJIANG GEELY HOLDING GROUP CO., LTD.	34

N° Exp	Resolución	Marca	Clases	Titular	Ag.
524061	02/09/2022	YES I AM DELICIOUS (mixta)	3 (Concedida S/D)	L'OREAL	144
524063	02/09/2022	HARMONT & BLAINE (mixta)	35 (Concedida S/D), 25 (Concedida S/D) y 18 (Concedida S/D)	HARMONT & BLAINE S.P.A.	144
524065	02/09/2022	V VACANTED TM + OPORTUNIDADES + EDUCACIÓN (mixta)	41 (Concedida) y 35 (Concedida)	GONZALEZ IZAGUIRRE, CARLOS ANIBAL	201
524066	02/09/2022	(figurativa)	11 (Concedida S/D) y 9 (Concedida S/D)	QINGDAO YEELINK INFORMATION TECHNOLOGY CO., LTD	94
524067	02/09/2022	YEELIGHT (mixta)	11 (Concedida S/D) y 9 (Concedida S/D)	QINGDAO YEELINK INFORMATION TECHNOLOGY CO., LTD	94
524068	02/09/2022	BEEP	3 (Concedida S/D)	Hanschell Inniss Holdings (Curacao) N.V.	181
524070	02/09/2022	BEEP	5 (Concedida S/D)	Hanschell Inniss Holdings (Curacao) N.V.	181
524072	09/09/2022	VANS "OFF THE WALL" VERSA HOODIE (mixta)	25 (Concedida S/D)	Vans, Inc.	245
524074	09/09/2022	DOG URUGUAY HACE DÚO CON TU CAN NESW (mixta)	41 (Concedida)	SERRON GIMENEZ, JUAN CARLOS	201
524075	09/09/2022	VITÉ-DETOX	3 (Concedida)	TERGEN S.A.	181
524076	09/09/2022	VITÉ-INSTANT	3 (Concedida)	TERGEN S.A.	181
524077	02/09/2022	FULANA. (mixta)	42 (Concedida), 41 (Concedida) y 35 (Concedida)	OTERO FRONTAN MARTIN ALBERTO	220
524078	19/09/2022	SECUNEX (mixta)	42 (Concedida S/D)	TOTALMAR SA	
524081	09/09/2022	VOXIE	9 (Concedida S/D)	Vimar S.p.A.	192
524091	09/09/2022	PREHOUSE CONSTRUCCIÓN INTELIGENTE (mixta)	37 (Concedida) y 35 (Concedida)	BERRO MEZZERA, ALEJANDRO	189
524094	09/09/2022	(figurativa)	16 (Concedida)	CMPC TISSUE S.A.	218
524099	09/09/2022	REVESDERECHO (mixta)	23 (Concedida S/D)	Grupo NR Spa	212
524100	09/09/2022	M MECHE COCINA CON AMOR (mixta)	35 (Concedida) y 30 (Concedida)	MERCEDES RODRIGUEZ CARRERA	186

N° Exp	Resolución	Marca	Clases	Titular	Ag.
524102	02/09/2022	AKO ZINC SEED (mixta)	1 (Concedida)	TILENUR S.A.	154
524103	02/09/2022	AKO ZINC FLOW (mixta)	1 (Concedida)	TILENUR S.A.	154
524106	02/09/2022	TANG (mixta)	32 (Concedida S/D)	Intercontinental Great Brands LLC	227
524109	02/09/2022	COMPRAVENDETUMARCA.COM (mixta)	42 (Concedida S/D)	Josue Echavarría Lopez	144
524111	02/09/2022	SENFINECO GERMANY	4 (Concedida), 3 (Concedida) y 1 (Concedida)	Service Car Technology Vertreibs GmbH	144
524112	02/09/2022	FYNN CAPITAL (mixta)	36 (Concedida)	ENRIQUE FYNN CAPITAL S.A.	186
524113	09/09/2022	ROSETO 1927	3 (Concedida S/D)	Bruno Nigro Homar	
524114	02/09/2022	GREAT HEIGHTS	3 (Concedida S/D)	MARY KAY INC.	144
524115	02/09/2022	MERCEDES-EQ	43 (Concedida S/D), 41 (Concedida S/D), 39 (Concedida S/D), 37 (Concedida S/D), 36 (Concedida S/D) y 35 (Concedida S/D)	Mercedes-Benz Group AG.	144
524117	02/09/2022	(figurativa)	12 (Concedida S/D)	Youdao Rubber Co., LTD	34
524119	02/09/2022	BIGPRINTS (mixta)	16 (Concedida S/D)	Giancarlo Rochinotti	
524122	02/09/2022	CARAT	42 (Concedida) y 36 (Concedida)	Fiserv, Inc.	201
524125	02/09/2022	Z FLIP	9 (Concedida S/D)	SAMSUNG ELECTRONICS CO., LTD.	201
524131	02/09/2022	LA ENCANTADORA (mixta)	30 (Concedida)	SOUTO, BIBANA	245
524132	02/09/2022	HONORA	29 (Concedida S/D)	Compañía Nacional de Levaduras Levapan S.A.	216
524133	02/09/2022	MOKI DECO	16 (Concedida S/D)	Gonzalo González	
524134	02/09/2022	SUPERMERCADO PERCAT (mixta)	35 (Concedida S/D)	Mateo Perez	
524135	02/09/2022	PERCAT HOME (mixta)	35 (Concedida S/D)	Mateo Perez	
524142	02/09/2022	DON GIOVANNI	29 (Concedida)	CATTIVELLI HNOS. S.A.	129
524143	02/09/2022	ECO MÁS (mixta)	5 (Concedida S/D)	CHAVES MUNIZ JUAN CARLOS Y GONZALEZ VICTORIA RODOLFO	

N° Exp	Resolución	Marca	Clases	Titular	Ag.
				JAIRCINHO SOCIEDAD DE HECHO	
524152	02/09/2022	WITBOR (mixta)	42 (Concedida S/D)	WITBOR ESPAÑA S.L.	234
524157	02/09/2022	SEM	1 (Concedida S/D)	Caterpillar (Qingzhou) Ltd.	181
524171	02/09/2022	EL IRLANDES COCINA CON AMOR (mixta)	43 (Concedida)	Joaquín Benia O'Neill	244
524177	02/09/2022	AVÍCOLA EL CANARIO (mixta)	29 (Concedida S/D)	Williton srl	
524179	02/09/2022	LUNATICS BROTHERHOOD (mixta)	25 (Concedida S/D)	Matías Nicolás Lezué Conde	
524182	02/09/2022	INNOVANATURALS (mixta)	35 (Concedida) y 5 (Concedida)	INNOVAPHARMA S.A.	94
524184	02/09/2022	LIMZUL	3 (Concedida S/D)	ALICORP ARGENTINA S.C.A.	212
524185	02/09/2022	SAMADHI	25 (Concedida)	Rodolfo German Goldman Grünberg	144
524187	02/09/2022	MENFORSAN (mixta)	5 (Concedida S/D)	OSCAR MESANZA MATIA	94
524188	02/09/2022	(tridimensional)	21 (Concedida)	MARIA FLORENCIA MITNIK CARRAU	212
524197	02/09/2022	FACTURANDO.UY (mixta)	42 (Concedida S/D) y 35 (Concedida S/D)	Nahuel Pratto	
524201	02/09/2022	TIENDAPP (mixta)	42 (Concedida S/D)	TIENDAPP S.A.S	
524207	02/09/2022	PYRENEX (mixta)	25 (Concedida)	PYRENEX	179
524219	05/09/2022	TECHNOBEEF MEAT EXPERTS (mixta)	9 (Concedida)	TECHNOBEEF SAS	201
524221	02/09/2022	DAIRY PACK (mixta)	42 (Concedida S/D), 37 (Concedida S/D) y 7 (Concedida S/D)	SYNERLINK IBERICA, S.L.U.	144
524232	02/09/2022	ANGELES & FLORES (mixta)	35 (Concedida) y 25 (Concedida)	PRILI S.A.	245
524242	06/09/2022	RICH'S GOLD LABEL CAKE AND DESSERT TOPPING BORN FROM INNOVATION (mixta)	30 (Concedida S/D)	RICH PRODUCTS CORPORATION	194
524244	02/09/2022	WRANGLER TERRITORY HT	12 (Concedida S/D)	The Goodyear Tire & Rubber Company	144
524247	05/09/2022	MUNDIAL SMARTKNIVES (mixta)	9 (Concedida S/D) y 8 (Concedida S/D)	MUNDIAL S/A PRODUTOS DE CONSUMO	194

N° Exp	Resolución	Marca	Clases	Titular	Ag.
524255	02/09/2022	CLARO CONNECT (mixta)	38 (Concedida S/D)	Claro S.A.	181
524256	02/09/2022	GLOBAL CAPITAL (mixta)	36 (Concedida S/D)	Emanuel Gutierrez	
524261	02/09/2022	OMG! - EVENTOS & COMUNICACIÓN (mixta)	41 (Concedida) y 35 (Concedida)	Ohmygod SRL . y Patricia Rodriguez	
524277	02/09/2022	GO (mixta)	36 (Concedida) y 35 (Concedida)	THE BANK OF NOVA SCOTIA	94
524280	02/09/2022	GO (mixta)	36 (Concedida) y 35 (Concedida)	THE BANK OF NOVA SCOTIA	94
524284	05/09/2022	INTEGRA A PROSEGUR SOLUTION (mixta)	45 (Concedida S/D), 42 (Concedida S/D), 39 (Concedida S/D), 37 (Concedida S/D), 35 (Concedida S/D) y 9 (Concedida S/D)	PROSEGUR Compañía de Seguridad, S.A.	144
524285	02/09/2022	RIPIO (mixta)	36 (Concedida S/D)	NETANY S.A.	94
524287	02/09/2022	RIPIO TU PUERTA DE ACCESO AL MUNDO CRIPTO	36 (Concedida S/D)	NETANY S.A.	94
524288	02/09/2022	(figurativa)	36 (Concedida S/D)	NETANY S.A.	94
524289	02/09/2022	(figurativa)	36 (Concedida S/D)	NETANY S.A.	94
524295	05/09/2022	BITCOINTRADE (mixta)	36 (Concedida S/D) y 9 (Concedida S/D)	NETANY S.A.	94
524296	02/09/2022	FRILO	36 (Concedida S/D)	NETANY S.A.	94
524297	02/09/2022	FRILO (mixta)	36 (Concedida S/D)	NETANY S.A.	94
524301	02/09/2022	BIA SAIGON EXPORT EST. 1875 ORIGINAL PREMIUM QUALITY BEER FROM VIETNAM (mixta)	32 (Concedida S/D)	SAIGON BEER – ALCOHOL – BEVERAGE CORPORATION	34
524303	02/09/2022	CHARLIE URUGUAY	25 (Concedida)	Carla Victoria Romero Sena	
524310	02/09/2022	MOONA CROISSANTERIE (mixta)	43 (Concedida) y 30 (Concedida)	CECILIA AGUIRRE	
524311	02/09/2022	BOROFONE (mixta)	9 (Concedida S/D)	HOCO TECHNOLOGY DEVELOPMENT (SHENZHEN) CO. LTD.	34

N° Exp	Resolución	Marca	Clases	Titular	Ag.
524312	02/09/2022	CRIATURAS NOCTURNAS (mixta)	43 (Concedida) y 32 (Concedida)	CRIATURAS NOCTURNAS S.R.L	212
524313	02/09/2022	CRIATURAS NOCTURNAS (mixta)	43 (Concedida) y 32 (Concedida)	CRIATURAS NOCTURNAS S.R.L	212
524314	02/09/2022	DAYONE (mixta)	11 (Concedida S/D)	Guangzhou Deyouer E-Commerce Co., Ltd.	34
524318	02/09/2022	APPASO (mixta)	11 (Concedida S/D)	Shenzhen Xinyanghui E-commerce Co, Ltd.	34
524319	02/09/2022	COLLAVANT	5 (Concedida S/D) y 1 (Concedida S/D)	BIOIBERICA, S.A.U.	94
524320	02/09/2022	C (mixta)	42 (Concedida S/D), 41 (Concedida S/D), 36 (Concedida S/D), 35 (Concedida S/D) y 9 (Concedida S/D)	Coinbase, Inc.	216
524321	02/09/2022	COLLAVANT (mixta)	5 (Concedida S/D) y 1 (Concedida S/D)	BIOIBERICA, S.A.U.	94
524328	05/09/2022	CHAU TACC	35 (Concedida), 30 (Concedida) y 29 (Concedida)	TORRES SILVA, NATALIA	201
524329	02/09/2022	CELMANAX	5 (Concedida S/D)	CHURCH & DWIGHT CO., INC	34
524330	05/09/2022	A-MAX	5 (Concedida S/D)	CHURCH & DWIGHT CO., INC	34
524331	02/09/2022	ADAPLIS	5 (Concedida S/D) y 1 (Concedida S/D)	SYNGENTA CROP PROTECTION AG	194
524332	02/09/2022	KALYKIM (mixta)	3 (Concedida)	KALYKIM INDUSTRIA E COMERCIO LTDA.	34
524334	02/09/2022	CAPT. VIEW (mixta)	37 (Concedida)	Andrea Cetraro Calvo	232
524339	02/09/2022	COVIFAB	5 (Concedida S/D)	INMUNOVA S.A	34
524341	02/09/2022	FIBERCELL	21 (Concedida S/D), 16 (Concedida S/D), 7 (Concedida S/D) y 1 (Concedida S/D)	Björkemar Construction & Consulting BCC AB	144
524342	02/09/2022	BY F (mixta)	35 (Concedida) y 25 (Concedida)	ARROSA SHAW, FLORENCIA MARIA	201

N° Exp	Resolución	Marca	Clases	Titular	Ag.
524345	02/09/2022	HANG LOOSE (mixta)	35 (Concedida S/D), 18 (Concedida), 9 (Concedida) y 6 (Concedida)	SURF CO LTDA.	144
524346	02/09/2022	NOMADE	42 (Concedida) y 35 (Concedida)	JORCÍN FERNÁNDEZ, SEBASTIÁN RAMIRO	201
524348	02/09/2022	PUNTA TRACKING (mixta)	45 (Concedida) y 39 (Concedida)	OTECAR S.A.	201
524351	02/09/2022	SUL ATLANTICO	39 (Concedida)	Sul Atlântico Brasil Transportes LTDA	245
524354	02/09/2022	INTRAPROP	42 (Concedida) y 9 (Concedida)	INTRAPROP S.A.S.	
524358	02/09/2022	DAMAP	42 (Concedida S/D) y 38 (Concedida S/D)	INTELITECH SAS	
524360	02/09/2022	EZATECT	5 (Concedida S/D)	Elanco Tiergesundheits AG	205
524361	02/09/2022	ESTEFAN SUPERMERCADO (mixta)	35 (Concedida)	SUCESORES DE JORGE ESTEFAN S.A.	192
524362	02/09/2022	JONES & CIA. S.A.	45 (Concedida)	JONES & CIA. S.A.	192
524377	02/09/2022	GOOD FORTUNE	3 (Concedida S/D)	L'OREAL	144
524378	02/09/2022	OM PHARMA (mixta)	44 (Concedida S/D), 10 (Concedida S/D) y 5 (Concedida S/D)	OM Pharma SA	194
524379	02/09/2022	T-DAGGER (mixta)	35 (Concedida S/D), 28 (Concedida S/D) y 9 (Concedida S/D)	EASTERN TIMES TECHNOLOGY CO., LTD.	144
524382	02/09/2022	HORNEADO NEVER FRITO NE-CAR BEEF BBQ (mixta)	30 (Concedida)	MUNCHING SOCIEDAD ANONIMA	194
524384	02/09/2022	HORNEADO NEVER FRITO QUE- SO-SO CHED DAR (mixta)	30 (Concedida)	MUNCHING SOCIEDAD ANONIMA	194
524385	02/09/2022	MY WAY NEGOCIOS INMOBILIARIOS (mixta)	36 (Concedida S/D)	CETRANGOLO ALTHALLER, JAVIER	34
524387	02/09/2022	HORNEADO NEVER FRITO SA-	30 (Concedida)	MUNCHING SOCIEDAD ANONIMA	194

N° Exp	Resolución	Marca	Clases	Titular	Ag.
		BRO-SO INDI CO (mixta)			
524389	02/09/2022	HORNEADO NEVER FRITO CALIEN-TE MEXI CANO (mixta)	30 (Concedida)	MUNCHING SOCIEDAD ANONIMA	194
524392	02/09/2022	CAPLICIA	5 (Concedida S/D) y 1 (Concedida S/D)	SYNGENTA CROP PROTECTION AG	194
524393	02/09/2022	BLERONTI	5 (Concedida S/D) y 1 (Concedida S/D)	SYNGENTA CROP PROTECTION AG	194
524403	21/09/2022	(figurativa)	1 (Concedida S/D)	Caterpillar (Qingzhou) Ltd.	181
524417	02/09/2022	PPM PAPELES POR MAYOR (mixta)	35 (Concedida)	Juan Pablo Genta y Tatiana Leone	220
524421	02/09/2022	IMANIX (mixta)	28 (Concedida)	BRAIN TOYS SPA	201
524425	02/09/2022	(figurativa)	35 (Concedida), 25 (Concedida), 18 (Concedida) y 3 (Concedida)	YOLANDA BEATRIZ YAPUR	94
524426	05/09/2022	PV PELUQUERÍAS.VOY (mixta)	39 (Concedida) y 9 (Concedida)	LLANES BENTANCOR MAURICIO ANDRES	220
524428	02/09/2022	MINIME	24 (Concedida)	LETICIA MARCENARO	
524429	02/09/2022	MINIMI	25 (Concedida) y 24 (Concedida)	LETICIA MARCENARO	
524431	06/09/2022	LEYTON INSURANCE BROKERS (mixta)	36 (Concedida)	FABIAN LEYTON MELCONIAN	223
524432	09/09/2022	BRIGHT ORANGE (mixta)	34 (Concedida S/D)	COMPAÑIA INDUSTRIAL DE TABACOS MONTE-PAZ S.A.	245
524436	09/09/2022	FOREST GREEN (mixta)	34 (Concedida S/D)	COMPAÑIA INDUSTRIAL DE TABACOS MONTE-PAZ S.A.	245
524437	09/09/2022	SUNSET AMBER (mixta)	34 (Concedida S/D)	COMPAÑIA INDUSTRIAL DE TABACOS MONTE-PAZ S.A.	245
524438	02/09/2022	ARKUS GADOR	5 (Concedida S/D)	LABORATORIO GADOR S.A.	165
524440	09/09/2022	SWEET YELLOW (mixta)	34 (Concedida S/D)	COMPAÑIA INDUSTRIAL DE TABACOS MONTE-PAZ S.A.	245
524443	02/09/2022	(figurativa)	32 (Concedida S/D)	Genki Forest (Beijing) Food Technology Group	34

N° Exp	Resolución	Marca	Clases	Titular	Ag.
				Co., Ltd.	
524448	09/09/2022	CRIMSON RED (mixta)	34 (Concedida S/D)	COMPAÑIA INDUSTRIAL DE TABACOS MONTE-PAZ S.A.	245
524449	05/09/2022	GENKI FOREST (mixta)	32 (Concedida S/D)	Genki Forest (Beijing) Food Technology Group Co., Ltd.	34
524452	06/09/2022	LA CASA DE LA ABERTURA (mixta)	37 (Concedida) y 35 (Concedida)	ABERTURAS ALUMINO SRL	34
524453	05/09/2022	JOBCHAIN	42 (Concedida), 36 (Concedida) y 9 (Concedida)	Jobchain Enterprises GmbH	94
524454	02/09/2022	QFITLIA	5 (Concedida S/D)	GENZYME CORPORATION	144
524456	21/09/2022	PLANTS NOT PILLS TM (mixta)	5 (Concedida)	Juan Cruz Baccon Ramírez	144
524457	21/09/2022	EL GRAN PASTELERO BAKE OFF URUGUAY	41 (Concedida S/D), 38 (Concedida S/D), 21 (Concedida S/D), 16 (Concedida S/D) y 9 (Concedida S/D)	Love Productions Limited	194
524458	02/09/2022	CLEVIVIQ	5 (Concedida S/D) y 1 (Concedida S/D)	SYNGENTA CROP PROTECTION AG	194
524459	05/09/2022	KEDS (mixta)	25 (Concedida S/D)	KEDS, LLC	194
524460	05/09/2022	DUSIAX	5 (Concedida S/D) y 1 (Concedida S/D)	SYNGENTA CROP PROTECTION AG	194
524469	06/09/2022	MODZIA	5 (Concedida S/D)	BIOSIDUS S.A.	201
524531	02/09/2022	MONSTAS! (mixta)	25 (Concedida)	Juan Grunwaldt	186
524532	13/09/2022	LIDOXA- LIDOCAINA CLORHIDRA JALEA	5 (Concedida S/D)	OXAPHARMA S.A.	34
524538	02/09/2022	COBERPET	44 (Concedida S/D) y 35 (Concedida S/D)	QUIROMAS S.A.	181
524551	02/09/2022	AGROPECUARIA LA ESCALERA (mixta)	44 (Concedida) y 29 (Concedida)	Agropecuaria La Escalera SRL	212

N° Exp	Resolución	Marca	Clases	Titular	Ag.
524552	02/09/2022	CRESEMBA (mixta)	5 (Concedida S/D)	Basilea Pharmaceutica AG	144
524554	02/09/2022	INK (mixta)	29 (Concedida)	Agropecuaria La Escalera SRL	212
524562	02/09/2022	N (mixta)	35 (Concedida), 28 (Concedida) y 25 (Concedida)	IGARZABAL VAINER, ENRIQUE JAVIER	245
524566	02/09/2022	GSE (mixta)	28 (Concedida S/D), 27 (Concedida S/D) y 12 (Concedida S/D)	Opel Automobile GmbH	194
524569	06/09/2022	LA BIOFÁBRICA (mixta)	44 (Concedida S/D), 42 (Concedida S/D) y 5 (Concedida S/D)	YAKIMIK QUINTANILLA NICOLAS, CAMACHO HAMILTO ESTEFANI CAROLINA Y OTROS SOCIEDAD DE HECHO	
524587	02/09/2022	TAPARI ANGUS (mixta)	29 (Concedida)	AGROMEALS S.A.	194
524590	02/09/2022	TECNO SPARK (mixta)	9 (Concedida S/D)	SHENZHEN TRANSHAN TECHNOLOGY LIMITED	34
524603	02/09/2022	MELANIA DRESS	42 (Concedida S/D)	Flavia Ferreira	
524607	02/09/2022	CILENTO (mixta)	25 (Concedida) y 18 (Concedida)	Natalia Cornara	
524613	09/09/2022	ZOÉ (mixta)	3 (Concedida)	Techplus SAS	220
524615	09/09/2022	SIGNSTORE SOLUCIONES DE MARCA (mixta)	35 (Concedida)	ENIAFEN S.A.	220
524617	09/09/2022	RLI RED LEGAL IBEROAMERICANA (mixta)	45 (Concedida S/D)	ORAWON S.A.	
524618	09/09/2022	FERMENTORIO (mixta)	43 (Concedida) y 32 (Concedida)	CRIATURAS NOCTURNAS S.R.L y Lucio Adolfo Faina Perez	212
524620	09/09/2022	LEOPARD (mixta)	12 (Concedida S/D)	REIMPEX S.R.L.	34
524621	09/09/2022	VILA VOLVER A LAS MEJORES TRADICIONES (mixta)	43 (Concedida), 37 (Concedida) y 36 (Concedida)	Agropecuaria La Escalera SRL	212
524622	09/09/2022	BYLOWE	25 (Concedida) y 3	ANDREA LAURA VILA PEREIRA y EDGAR	

N° Exp	Resolución	Marca	Clases	Titular	Ag.
			(Concedida)	GONZALO CABRAL SUARES	
524625	09/09/2022	KEINSUMOS	42 (Concedida), 35 (Concedida) y 9 (Concedida)	KEINSUMOS SA	
524630	09/09/2022	GRACEBIS	5 (Concedida S/D) y 1 (Concedida S/D)	SYNGENTA CROP PROTECTION AG	194
524632	09/09/2022	BHEALTH INTERNATIONAL	44 (Concedida), 42 (Concedida), 36 (Concedida) y 9 (Concedida)	B Health S.A	245
524633	09/09/2022	GOBISTRA	5 (Concedida S/D) y 1 (Concedida S/D)	SYNGENTA CROP PROTECTION AG	194
524635	09/09/2022	HOLTIGER	5 (Concedida S/D) y 1 (Concedida S/D)	SYNGENTA CROP PROTECTION AG	194
524636	09/09/2022	SMITH 44	32 (Concedida S/D)	CASA DI CONTI LTDA	217
524637	12/09/2022	BHI	44 (Concedida), 42 (Concedida), 36 (Concedida) y 9 (Concedida)	B Health S.A	245
524638	09/09/2022	HOMENTER	5 (Concedida S/D) y 1 (Concedida S/D)	SYNGENTA CROP PROTECTION AG	194
524640	09/09/2022	BHI BHEALTH INTERNATIONAL (mixta)	44 (Concedida), 42 (Concedida), 36 (Concedida) y 9 (Concedida)	B Health S.A	245
524643	09/09/2022	FAME	3 (Concedida S/D)	PUIG FRANCE, Société par Actions Simplifiée	245
524644	09/09/2022	VILA (mixta)	29 (Concedida S/D)	ONTILCOR S.A.	212
524645	09/09/2022	A ARMIBÁ (mixta)	35 (Concedida)	Agustín Miranda	
524646	09/09/2022	CRONOS URUGUAY (mixta)	39 (Concedida S/D)	Hebber Cigarán	
524654	09/09/2022	LÚMINA JOYAS & DISEÑO (mixta)	14 (Concedida)	Cecilia Paratge Debellis	
524657	09/09/2022	TAVASCAN	35 (Concedida S/D),	SEAT S.A.	216

N° Exp	Resolución	Marca	Clases	Titular	Ag.
			27 (Concedida S/D), 25 (Concedida S/D) y 12 (Concedida S/D)		
524660	09/09/2022	HONOR MAGIC	9 (Concedida S/D)	Honor Device Co., Ltd.	201
524661	09/09/2022	PIKLER	41 (Concedida), 28 (Concedida) y 20 (Concedida)	Magyarországi Pikler-Lóczy Társaság	105
524666	09/09/2022	ROVAXIN	5 (Concedida)	ICU-VITA S.A.	201
524668	09/09/2022	HALAXIA (mixta)	9 (Concedida S/D)	BONARIEL S.A.	201
524669	09/09/2022	AMONG US	28 (Concedida S/D), 25 (Concedida S/D), 18 (Concedida S/D), 16 (Concedida S/D), 14 (Concedida S/D) y 9 (Concedida S/D)	Innersloth LLC	144
524670	09/09/2022	AMONG US (mixta)	28 (Concedida S/D), 25 (Concedida S/D), 18 (Concedida S/D), 16 (Concedida S/D), 14 (Concedida S/D) y 9 (Concedida S/D)	Innersloth LLC	144
524671	09/09/2022	REÀL (mixta)	32 (Concedida S/D)	Clark Foods, Inc.	194
524673	09/09/2022	SIMPLY SQUEEZE REÀL (mixta)	32 (Concedida S/D)	Clark Foods, Inc.	194
524674	19/09/2022	(figurativa)	28 (Concedida S/D), 25 (Concedida S/D), 18 (Concedida S/D), 16 (Concedida S/D), 14 (Concedida S/D) y 9 (Concedida S/D)	Innersloth LLC	144
524677	09/09/2022	AMSTEL LAGER 1870 A - PREMIUM	32 (Concedida S/D)	Amstel Brouwerij B.V.	194

N° Exp	Resolución	Marca	Clases	Titular	Ag.
		BIER - BREWED TO THE AMSTEL TRADITION (mixta)			
524678	19/09/2022	LABRADOR R CALIDAD Y PRESTIGIO (mixta)	29 (Concedida S/D)	Sergio Labrador	
524679	09/09/2022	CLEMENTONI (mixta)	28 (Concedida S/D) y 9 (Concedida S/D)	CLEMENTONI S.P.A.	144
524682	09/09/2022	SUPERHUMAN HEARING	28 (Concedida S/D) y 9 (Concedida S/D)	Voyetra Turtle Beach, Inc.	240
524683	09/09/2022	QUEEN LLANTAS Y NEUMÁTICOS R (mixta)	12 (Concedida S/D)	AUTECO MOBILITY S.A.S.	144
524684	09/09/2022	ATG ALL TERRAIN GEAR WRANGLER	25 (Concedida S/D)	Wrangler Apparel Corp.	194
524690	09/09/2022	VIAPLAY	41 (Concedida S/D), 38 (Concedida S/D), 35 (Concedida S/D) y 9 (Concedida S/D)	Nordic Entertainment Group Sweden AB	245
524691	09/09/2022	VIAPLAY (mixta)	41 (Concedida S/D), 38 (Concedida S/D), 35 (Concedida S/D) y 9 (Concedida S/D)	Nordic Entertainment Group Sweden AB	245
524695	09/09/2022	TOP HAIR MONTEVIDEO (mixta)	44 (Concedida)	MARATHON MONTEVIDEO S.R.L.	201
524696	09/09/2022	HAIRMAX	44 (Concedida)	MARATHON MONTEVIDEO S.R.L.	201
524697	09/09/2022	KLUBB	37 (Concedida S/D) y 7 (Concedida S/D)	KLUBB	179
524700	09/09/2022	SIMPLIROUTE (mixta)	42 (Concedida), 39 (Concedida) y 9 (Concedida)	Simpliroute SAS	181
524707	09/09/2022	FORTE MOTORCYCLE PARTS (mixta)	12 (Concedida S/D)	L.H. S.A.	201
524710	09/09/2022	VOLTA CYCLING LOVERS (mixta)	12 (Concedida S/D)	L.H. S.A.	201
524711	09/09/2022	TRANQUILO BAR (mixta)	43 (Concedida S/D)	José Pablo Chamorro	194

N° Exp	Resolución	Marca	Clases	Titular	Ag.
524713	09/09/2022	RECETAS ¡QUÉ RICO! (mixta)	41 (Concedida) y 35 (Concedida)	HENDERSON & CIA. S.A.	181
524715	09/09/2022	SOVOS	10 (Concedida S/D)	SMITHS MEDICAL ASD, INC	34
524717	09/09/2022	TRAXPALCO (mixta)	37 (Concedida)	Traxpalco S.A.	194
524718	09/09/2022	HARRY´S BAR	41 (Concedida)	ALTUNIS - TRADING, GESTÃO E SERVIÇOS SOCIEDADE UNIPessoal, LDA.	212
524720	09/09/2022	WXC MACHINERY (mixta)	7 (Concedida S/D)	WUXI XINGCHENG PRINTING & DYEING MACHINERY CO.,LTD	144
524721	09/09/2022	KRALYS (mixta)	39 (Concedida)	Kralys S.A	194
524722	09/09/2022	CONDROTIDE	5 (Concedida S/D)	MASTELLI S.R.L.	144
524725	09/09/2022	LUMIÈRE CENTRO INTERDISCIPLINARIO (mixta)	44 (Concedida) y 41 (Concedida)	DE SOUZA OLID, MARIA NOEL	201
524726	09/09/2022	SCHIAPARELLI (mixta)	25 (Concedida), 18 (Concedida), 14 (Concedida), 9 (Concedida) y 3 (Concedida)	INTERBASIC HOLDING S.R.L.	212
524727	09/09/2022	WATUXO	5 (Concedida S/D)	Glaxo Group Limited	216
524728	09/09/2022	XEVUDY	5 (Concedida S/D)	Glaxo Group Limited	216
524731	21/09/2022	BOLIE (mixta)	28 (Concedida) y 20 (Concedida)	Federica del Campo Soto y Sofia del Campo Soto	229
524735	09/09/2022	AUTOSHOP (mixta)	35 (Concedida S/D)	roberto delfante	
524737	09/09/2022	OKETTZ	45 (Concedida)	ALDO MAXIMO SILVERA CABOS y STEPHANIE DEBIE LUBLINSKI COLINA	37
524740	09/09/2022	DÍA DE LOS ÑOQUIS	35 (Concedida)	CRISTOBAL LANZA	129
524742	09/09/2022	PLUREN (mixta)	36 (Concedida S/D), 35 (Concedida S/D), 25 (Concedida S/D), 24 (Concedida S/D) y 21 (Concedida S/D)	LOJAS RENNER S.A.	34

N° Exp	Resolución	Marca	Clases	Titular	Ag.
524746	09/09/2022	XIAOMI (mixta)	45 (Concedida), 42 (Concedida), 41 (Concedida), 39 (Concedida), 38 (Concedida), 37 (Concedida), 36 (Concedida), 35 (Concedida), 28 (Concedida), 25 (Concedida), 24 (Concedida), 21 (Concedida), 18 (Concedida), 16 (Concedida), 15 (Concedida), 14 (Concedida), 12 (Concedida), 11 (Concedida), 10 (Concedida), 9 (Concedida), 8 (Concedida), 7 (Concedida), 3 (Concedida) y 2 (Concedida)	XIAOMI INC.	34
524758	09/09/2022	MI (mixta)	45 (Concedida), 42 (Concedida), 41 (Concedida), 39 (Concedida), 38 (Concedida), 37 (Concedida), 36 (Concedida), 35 (Concedida)	XIAOMI INC.	34

N° Exp	Resolución	Marca	Clases	Titular	Ag.
			(Concedida), 28 (Concedida), 25 (Concedida), 24 (Concedida), 21 (Concedida), 18 (Concedida), 16 (Concedida), 15 (Concedida), 14 (Concedida), 12 (Concedida), 11 (Concedida), 10 (Concedida), 9 (Concedida), 8 (Concedida), 7 (Concedida), 3 (Concedida) y 2 (Concedida)		
524760	21/09/2022	LIGA DE ASCENSO PROFESIONAL (mixta)	41 (Concedida), 38 (Concedida) y 35 (Concedida)	TENFIELD S.A.	34
524761	09/09/2022	THE PHONE LAB (mixta)	37 (Concedida) y 35 (Concedida)	Grupo Lab SRL	34
524767	19/09/2022	INNOVA (mixta)	45 (Concedida), 37 (Concedida) y 9 (Concedida)	Securitas Sistemas SA	216
524768	19/09/2022	INNOVA (mixta)	45 (Concedida), 37 (Concedida) y 9 (Concedida)	Securitas Sistemas SA	216
524770	19/09/2022	TOTAL 12 (mixta)	21 (Concedida S/D) y 3 (Concedida S/D)	COLGATE-PALMOLIVE COMPANY	201
524773	19/09/2022	EL CONSENTIDO	43 (Concedida) y 40	Finca El Consentido SRL	232

N° Exp	Resolución	Marca	Clases	Titular	Ag.
			(Concedida)		
524775	19/09/2022	TURISTIQUE EXPERIENCIAS (mixta)	39 (Concedida) y 35 (Concedida)	Maria Julia Fernández Renna	212
524779	19/09/2022	MIL MILA´S (mixta)	43 (Concedida)	María Cecilia Díaz Chifoni	228
524780	19/09/2022	LA FUGAZZETA PIZZERIA (mixta)	43 (Concedida)	María Cecilia Díaz Chifoni	228
524781	19/09/2022	RECLAMEDIC	45 (Concedida)	Javier Riffaud	
524783	19/09/2022	NUDD	35 (Concedida), 21 (Concedida) y 20 (Concedida)	SHAFFER, LUCÍA	189
524784	19/09/2022	OVERBAG (mixta)	18 (Concedida)	María Victoria Cretenze Quartino	
524785	19/09/2022	K18	3 (Concedida S/D)	Aquis Hairsiences Inc.	94
524786	19/09/2022	K18 BIOMIMETIC HAIRSCIENCE	3 (Concedida S/D)	Aquis Hairsiences Inc.	94
524787	19/09/2022	VIVE (mixta)	36 (Concedida S/D) y 35 (Concedida S/D)	PENINSULA RENTALS URUGUAY S.R.L.	
524788	19/09/2022	RADIOSPORT	38 (Concedida) y 9 (Concedida)	ALBERTO MARTIN SCASSO VOLONTE	
524789	19/09/2022	SMELL FRESH (mixta)	5 (Concedida) y 3 (Concedida)	Aerosoles Hecspi S.A.C.I.F.I. Y DE M. Y S	194
524790	19/09/2022	PODIATECH	10 (Concedida)	Bergantinos S.C.	144
524791	19/09/2022	BEDROCK (mixta)	36 (Concedida) y 35 (Concedida)	OTERO, MARTIN CRISTIAN	201
524795	19/09/2022	LA BICI CAFÉ DE ESPECIALIDAD (mixta)	40 (Concedida S/D) y 30 (Concedida S/D)	CECÍLIA MARÍA GATZKE	94
524796	19/09/2022	LA BICI CAFÉ DE ESPECIALIDAD (mixta)	43 (Concedida S/D) y 35 (Concedida S/D)	CECÍLIA MARÍA GATZKE	94
524801	06/09/2022	AJ ALEXANDRE.J (mixta)	3 (Concedida S/D)	CREATION REALISATION MARKETING PARIS	181
524805	06/09/2022	INIA URUGUAY OPTIFERT-P (mixta)	44 (Concedida) y 42	Instituto Nacional De Investigación Agropecuaria	34

N° Exp	Resolución	Marca	Clases	Titular	Ag.
			(Concedida)	(Inia)	
524812	06/09/2022	P (mixta)	41 (Concedida S/D), 38 (Concedida S/D), 28 (Concedida S/D), 25 (Concedida S/D) y 9 (Concedida S/D)	Peloton Interactive, Inc.	136
524813	06/09/2022	VIAXLAB (mixta)	42 (Concedida S/D), 39 (Concedida) y 9 (Concedida S/D)	PULSERAPP SAS	201
524816	06/09/2022	KINGDOM RUSH (mixta)	9 (Concedida)	Ironhide S.A.	172
524832	06/09/2022	PRODAPT	10 (Concedida S/D) y 5 (Concedida S/D)	Fresenius Kabi AG	245
524835	06/09/2022	CINISCA396	25 (Concedida)	Carina Casas y Erika Mastomauro	154
524845	06/09/2022	BROKERWTC	36 (Concedida)	BROKER Bienes Raíces	194
524848	07/09/2022	UHC	1 (Concedida S/D)	RIZOBACTER ARGENTINA S.A	34
524849	06/09/2022	AUTOFACIL	39 (Concedida), 37 (Concedida), 36 (Concedida) y 12 (Concedida)	Maximiliano Saporito y Paula Pereyra	
524850	09/09/2022	PALMOLIVE ALIMENTO PARA TU PIEL	3 (Concedida S/D)	COLGATE-PALMOLIVE COMPANY	201
524851	06/09/2022	RICH'S ULTRA RICH (mixta)	29 (Concedida)	RICH PRODUCTS CORPORATION	194
524853	06/09/2022	VODELPA	5 (Concedida S/D)	NOVARTIS AG.	201
524854	06/09/2022	ALTIVITY	5 (Concedida S/D)	GUERBET	144
524856	09/09/2022	BUILD YOUR DREAMS (mixta)	12 (Concedida S/D)	BYD COMPANY LIMITED	201
524857	09/09/2022	ENRICHING LIVES TODAY FOR A SUSTAINABLE TOMORROW	35 (Concedida S/D)	MARY KAY INC.	144
524858	09/09/2022	ENRICHING LIVES TODAY FOR A SUSTAINABLE TOMORROW	36 (Concedida S/D)	MARY KAY INC.	144
524860	07/09/2022	3 MUSAS ESPACIO DE DISEÑO (mixta)	35 (Concedida)	CASCO BONEFON, MATIAS GONZALO	201

N° Exp	Resolución	Marca	Clases	Titular	Ag.
524868	07/09/2022	(figurativa)	18 (Concedida S/D)	Fendi s.r.l.	212
524869	06/09/2022	TT (mixta)	25 (Concedida S/D), 18 (Concedida S/D), 14 (Concedida S/D) y 9 (Concedida S/D)	River Light V, L.P.	212
524870	06/09/2022	T (mixta)	25 (Concedida S/D), 18 (Concedida S/D), 14 (Concedida S/D) y 9 (Concedida S/D)	River Light V, L.P.	212
524894	06/09/2022	MARIO KART	28 (Concedida S/D), 25 (Concedida S/D), 18 (Concedida S/D) y 9 (Concedida S/D)	Nintendo of America Inc.	136
524899	09/09/2022	RÉNERGIE H.C.F. TRIPLE SERUM (mixta)	3 (Concedida S/D)	L'OREAL	144
524906	09/09/2022	LA JUANA (mixta)	37 (Concedida) y 36 (Concedida)	CHAMERY SA	216
524907	09/09/2022	SPEERSTA	5 (Concedida S/D)	NOVARTIS AG.	201
524909	09/09/2022	PILAR DE LOS HORNEROS (mixta)	37 (Concedida) y 36 (Concedida)	DESARROLLO VERDE SAS	216
524911	30/09/2022	EASTWOOD (mixta)	20 (Concedida S/D)	Alfonso Maria Gallinal Ferrari	244
524922	19/09/2022	ÍNTEGRA CREADA EN COMUNIDAD (mixta)	30 (Concedida)	RAGNI, FERNANDO MANUEL; NAYEM, MARÍA PAULA y ROMANO, MARÍA LAURA	189
524926	09/09/2022	FERIA INCLUSIVA ONLINE URUGUAY (mixta)	41 (Concedida)	AGENCIA DE COMUNICACIONES Y MARKETING BLANCO 360 LTDA.	201
524931	09/09/2022	FLASHING MEADOWS	5 (Concedida)	DIVERSYL SA	154
524932	09/09/2022	LA LUCANA (mixta)	30 (Concedida S/D)	La Lucana Ltda	
524933	09/09/2022	MEMORABLE	35 (Concedida)	Gabriela Garcia	154
524945	19/09/2022	FONTUP	5 (Concedida S/D)	LABORATOIRES GRAND FONTAINE, S.L.	165
524952	19/09/2022	LAOSHAN (mixta)	32 (Concedida S/D)	Tsingtao Brewery Company Limited	245
524953	21/09/2022	BIOQUELL QUBE	11 (Concedida S/D)	Ecolab USA Inc.	144

N° Exp	Resolución	Marca	Clases	Titular	Ag.
524954	19/09/2022	PPG POWERCRON 10X	2 (Concedida S/D)	PPG INDUSTRIES OHIO, INC.	144
524955	19/09/2022	ESTACIÓN CENTRAL (mixta)	39 (Concedida S/D) y 35 (Concedida S/D)	Michelle Dreifus	
524956	19/09/2022	ORLADEYO	5 (Concedida S/D)	BioCryst Pharmaceuticals, Inc.	194
524965	19/09/2022	COSELO VOS	41 (Concedida S/D)	Ana Paula Meléndrez Atanasoff	
524970	21/09/2022	VCR PLAY	38 (Concedida)	TAUROZZI NEGRI, CARLOS DIEGO	189
524971	19/09/2022	THE REAL ESTATE MARKET (mixta)	36 (Concedida)	Cerro Largo 1484, Sociedad Limitada	
524979	21/09/2022	TYDUS	25 (Concedida S/D)	Rodriguez Suarez Juan Ignacio	
524981	21/09/2022	MSTZ (mixta)	43 (Concedida)	Christian Daniel Galdeano Alvarado	219
524982	21/09/2022	LA VALDESIA	30 (Concedida) y 29 (Concedida)	DIMELTON S.A.	189
524984	21/09/2022	ISSEY MIYAKE ME (mixta)	25 (Concedida S/D) y 18 (Concedida S/D)	Kabushiki Kaisha Miyake Design Jimusho (también comerciando como Miyake Design Studio)	221
524986	21/09/2022	HOMME PLISSÉ (mixta)	25 (Concedida S/D) y 18 (Concedida S/D)	Kabushiki Kaisha Miyake Design Jimusho (también comerciando como Miyake Design Studio)	221
524987	21/09/2022	I32 5. ISSEY MIYAKE (mixta)	25 (Concedida S/D) y 18 (Concedida S/D)	Kabushiki Kaisha Miyake Design Jimusho (también comerciando como Miyake Design Studio)	221
524997	21/09/2022	THERHIFITY	5 (Concedida S/D)	Merck Sharp & Dohme Corp.	181
524998	21/09/2022	WELIREG	5 (Concedida S/D)	Merck Sharp & Dohme Corp.	181
525006	07/09/2022	LYFNUA	5 (Concedida S/D)	MERCK SHARP & DOHME CORP.	216
525008	07/09/2022	TELUS	42 (Concedida S/D), 35 (Concedida S/D) y 9 (Concedida S/D)	TELUS CORPORATION	216
525017	07/09/2022	EV1 (mixta)	12 (Concedida S/D)	Kia Corporation	201
525018	12/09/2022	CAPITAL SOLEIL SOLAR DERM SCIENCE	3 (Concedida S/D)	L'OREAL	144
525019	07/09/2022	EV2 (mixta)	12 (Concedida S/D)	Kia Corporation	201

N° Exp	Resolución	Marca	Clases	Titular	Ag.
525020	07/09/2022	EV3 (mixta)	12 (Concedida S/D)	Kia Corporation	201
525021	07/09/2022	TOP HOUSE (mixta)	11 (Concedida), 9 (Concedida), 8 (Concedida) y 7 (Concedida)	COTO CENTRO INTEGRAL DE COMERCIALIZACION S.A.	34
525023	09/09/2022	EV4 (mixta)	12 (Concedida S/D)	Kia Corporation	201
525025	09/09/2022	EV5 (mixta)	12 (Concedida S/D)	Kia Corporation	201
525026	09/09/2022	EV6 (mixta)	12 (Concedida S/D)	Kia Corporation	201
525027	09/09/2022	EV7 (mixta)	12 (Concedida S/D)	Kia Corporation	201
525028	09/09/2022	PEARL MILLING COMPANY	30 (Concedida)	The Quaker Oats Company	201
525029	29/09/2022	SYNEOS HEALTH	44 (Concedida S/D), 42 (Concedida S/D), 41 (Concedida S/D) y 35 (Concedida S/D)	Syneos Health, LLC	221
525030	07/09/2022	ECOLICUÁ (mixta)	36 (Concedida S/D)	ARTARIEN S.A	194
525031	09/09/2022	EV8 (mixta)	12 (Concedida S/D)	Kia Corporation	201
525033	09/09/2022	EV9 (mixta)	12 (Concedida S/D)	Kia Corporation	201
525034	29/09/2022	CERVEZA TOÑA NICARAGUA R 4.6% AC. VOL. CONT. NETO: 350 ML (120 OZ FL) PRODUCTO CENTROAMERICANO ELABORADO EN MANAGUA, NICARAGUA, POR COMPAÑÍA CERVECERA DE NICARAGUA, S.A. TEL. (505) 2255-7777 INGREDIENTES: AGUA, MALTAS, CEREALES Y LÚPULOS- REG. SAN. #45 PAÍSES CA-4 N° DE LOTE Y CONSUMIR PREFERENTEMENTE ANTES DEL: (VER BOTELLA). (mixta)	32 (Concedida S/D)	Inversiones Cerveceras Centroamericanas, S.A.	144

N° Exp	Resolución	Marca	Clases	Titular	Ag.
525036	07/09/2022	PROFIXMAN (mixta)	7 (Concedida S/D)	Ningbo Jiejie Tools Co., Ltd.	34
525037	07/09/2022	COCO REÁL	32 (Concedida S/D)	Clark Foods, Inc.	194
525040	07/09/2022	(figurativa)	44 (Concedida S/D), 10 (Concedida S/D) y 5 (Concedida S/D)	OM Pharma SA	194
525041	09/09/2022	KBIO (mixta)	5 (Concedida S/D)	BRITISH AMERICAN TOBACCO (BRANDS) LIMITED	194
525042	15/09/2022	CERVEZA HALCÓN PEREGRINO LIGTH CONTENIDO NETO: 350 ML. 4.9% ALC./VOL (mixta)	32 (Concedida S/D)	Inversiones Cerveceras Centroamericanas, S.A.	144
525043	09/09/2022	KIA EV1 (mixta)	12 (Concedida S/D)	Kia Corporation	201
525044	07/09/2022	BEILOX (mixta)	42 (Concedida) y 9 (Concedida)	Minuta S.A.	194
525045	09/09/2022	KIA EV2 (mixta)	12 (Concedida S/D)	Kia Corporation	201
525047	12/09/2022	KIA EV3 (mixta)	12 (Concedida S/D)	Kia Corporation	201
525048	09/09/2022	EMERGENT	40 (Concedida S/D), 39 (Concedida S/D) y 35 (Concedida S/D)	Lineage Logistics Holdings, LLC	240
525049	15/09/2022	CERVEZA HALCÓN PEREGRINO FROST 4.6% ALC./VOL. CONTENIDO NETO:350 ML. (mixta)	32 (Concedida S/D)	Inversiones Cerveceras Centroamericanas, S.A.	144
525050	12/09/2022	KIA EV4 (mixta)	12 (Concedida S/D)	Kia Corporation	201
525053	12/09/2022	KIA EV5 (mixta)	12 (Concedida S/D)	Kia Corporation	201
525057	12/09/2022	KIA EV6 (mixta)	12 (Concedida S/D)	Kia Corporation	201
525058	12/09/2022	KIA EV7 (mixta)	12 (Concedida S/D)	Kia Corporation	201
525059	12/09/2022	KIA EV8 (mixta)	12 (Concedida S/D)	Kia Corporation	201
525060	12/09/2022	KIA EV9 (mixta)	12 (Concedida S/D)	Kia Corporation	201
525062	09/09/2022	Z ZUCCHINO (mixta)	37 (Concedida)	ZUCCHINO MATRELLA, DARIO ERNESTO	245
525063	09/09/2022	IMAGINE	3 (Concedida S/D)	GUERLAIN	245
525064	15/09/2022	EQMAX (mixta)	12 (Concedida S/D)	EMPRESA BRASILEIRA DE PEÇAS E	144

N° Exp	Resolución	Marca	Clases	Titular	Ag.
				ACESSÓRIOS PARA AUTOS LTDA	
525066	07/09/2022	VROTE (mixta)	43 (Concedida) y 25 (Concedida)	MONIQUE ALICIA MORÁN LANZA; MARÍA DANIELA FLEITAS y CONSTANZA ISLA	168
525067	09/09/2022	E (mixta)	40 (Concedida S/D), 39 (Concedida S/D) y 35 (Concedida S/D)	Lineage Logistics Holdings, LLC	240
525070	07/09/2022	PATZU	25 (Concedida)	Jose Luis De Cunto	
525071	07/09/2022	(figurativa)	40 (Concedida S/D), 39 (Concedida S/D) y 35 (Concedida S/D)	Lineage Logistics Holdings, LLC	240
525072	09/09/2022	LINEAGE	40 (Concedida S/D), 39 (Concedida S/D) y 35 (Concedida S/D)	Lineage Logistics Holdings, LLC	240
525073	09/09/2022	BAINBRIDGE (mixta)	8 (Concedida S/D)	Ignacio Pigurina	
525074	09/09/2022	MONTEVIDEO BAKERY (mixta)	30 (Concedida S/D)	LARA CALDERON LAURA CAROLINA	
525075	15/09/2022	SINCE 1889 PEARL MILLING COMPANY (mixta)	30 (Concedida)	The Quaker Oats Company	201
525083	09/09/2022	CREBIO (mixta)	5 (Concedida S/D)	Natalia Posada	
525089	09/09/2022	FINANZAS ORGANIZADAS	35 (Concedida S/D)	María Noel Artave	
525091	15/09/2022	CONEXIÓN ALCANCE (mixta)	45 (Concedida S/D)	MARÍA INÉS GARCÍA ÁLVAREZ	192
525093	16/09/2022	ORNATE BIOPROFARMA BAGO	5 (Concedida S/D)	Gramón Bagó de Uruguay S.A.	181
525095	09/09/2022	C CALIER (mixta)	5 (Concedida S/D)	LABORATORIOS CALIER, S.A.	94
525101	13/09/2022	ITUY LAW FIRM (mixta)	45 (Concedida) y 35 (Concedida)	MAKARENA FERNÁNDEZ CEDRES; LORENZO BACIUCCO; GRACIELA RITA SOLER MALLO y HUGO SEBASTIÁN DÍAZ FERNÁNDEZ	
525105	13/09/2022	BE TOWER	42 (Concedida), 37 (Concedida) y 36	BINFOL S.A.	220

N° Exp	Resolución	Marca	Clases	Titular	Ag.
			(Concedida)		
525110	27/09/2022	TOPJET (mixta)	2 (Concedida S/D)	TOPJET TECHNOLOGY CO.,LTD.	34
525114	09/09/2022	CAR ONE (mixta)	43 (Concedida), 39 (Concedida), 35 (Concedida) y 12 (Concedida)	SANTA ROSA AUTOMOTORES SA	
525115	09/09/2022	CAR ONE VENTA INMEDIATA	35 (Concedida)	SANTA ROSA AUTOMOTORES SA	
525116	09/09/2022	CAR ONE CONSIGNACION	35 (Concedida)	SANTA ROSA AUTOMOTORES SA	
525117	07/09/2022	CRUCIJUEGOS	41 (Concedida) y 35 (Concedida)	CRUCIJUEGOS INSUMOS PUBLICOS SRL	144
525119	09/09/2022	ZAFIRO COLCHONES Y SOMMIERS (mixta)	20 (Concedida S/D)	LIMANSKY S.A.	216
525120	12/09/2022	KABALÁ VIVA	41 (Concedida)	Dafna Curiel	
525129	09/09/2022	RARE ONYX	3 (Concedida S/D)	AVON PRODUCTS, INC.	194
525131	09/09/2022	GURU STRAW (mixta)	34 (Concedida S/D)	KANTILAL CHAUDHRI,VISHNUBHAI	185
525139	09/09/2022	ITAÚ PAGOS	9 (Concedida)	BANCO ITAÚ URUGUAY S.A.	201
525154	07/09/2022	ANTOLINA	35 (Concedida)	LORIETO PAZOS VERONICA Y RUBINI BERKES ALEJANDRA LUISA SOCIEDAD DE HECHO	94
525155	12/09/2022	AMBIPAR RESPONSE (mixta)	40 (Concedida S/D)	AMBIPAR PARTICIPAÇÕES E EMPREENDIMENTOS S.A.	34
525160	09/09/2022	T.TAIO ESPONJABÓN (mixta)	21 (Concedida S/D) y 3 (Concedida S/D)	Industrias T.Taio, SA de CV	144
525162	09/09/2022	ULTRAGRIF (mixta)	11 (Concedida)	Alberto Fontana	186
525163	07/09/2022	PACÍFICA (mixta)	42 (Concedida) y 36 (Concedida)	Ezequiel Gil	186
525166	07/09/2022	VECINOS (mixta)	45 (Concedida), 42 (Concedida) y 9 (Concedida)	VECINOS LLC	34
525167	09/09/2022	KIT SABOR CELESTE	29 (Concedida)	LUIS G. BONOMI & CIA. S.A.	212
525168	09/09/2022	KIT SABOR CELESTE	30 (Concedida)	LUIS G. BONOMI & CIA. S.A	212

N° Exp	Resolución	Marca	Clases	Titular	Ag.
525170	09/09/2022	IMK NEW CAR'S (mixta)	39 (Concedida) y 35 (Concedida)	Ignacio Marcelo Meglioli	19
525172	12/09/2022	DEEPAGRO (mixta)	42 (Concedida)	DEEPAGRO HOLDING LLC	94
525181	09/09/2022	EPIXANN	5 (Concedida)	LABORATORIOS CAILLON & HAMONET S.A.C.I.	201
525182	09/09/2022	EPIXALEX	5 (Concedida)	LABORATORIOS CAILLON & HAMONET S.A.C.I.	201
525185	09/09/2022	CYH BEATY	5 (Concedida) y 3 (Concedida)	LABORATORIOS CAILLON & HAMONET S.A.C.I.	201
525187	13/09/2022	MED CLINICAL	3 (Concedida)	PASTEUR DE COSMIATRIA LTDA.	163
525188	09/09/2022	SACRE VERT	5 (Concedida) y 3 (Concedida)	LABORATORIOS CAILLON & HAMONET S.A.C.I.	201
525191	07/09/2022	KUKIE	25 (Concedida)	PACIFICO SUL INDUSTRIA TEXTIL e CONFECOES LTDA.	144
525192	07/09/2022	LIMOON	25 (Concedida)	PACIFICO SUL INDUSTRIA TEXTIL e CONFECOES LTDA.	144
525193	09/09/2022	LUC.BOO	25 (Concedida)	PACIFICO SUL INDUSTRIA TEXTIL e CONFECOES LTDA.	144
525194	07/09/2022	ECIJA (mixta)	45 (Concedida)	ELZEN ADVISORS S.A.S.	201
525197	12/09/2022	CELI RICO (mixta)	30 (Concedida)	Maria del Lourdes Márquez Costa	212
525198	12/09/2022	LOGISFASHION (mixta)	39 (Concedida)	LOGISFASHION, S.A.	181
525199	09/09/2022	GREENTILES (mixta)	19 (Concedida S/D)	TILES INVESTMENTS AND HOLDINGS, S.L.	94
525200	09/09/2022	MADISON	19 (Concedida S/D)	TILES INVESTMENTS AND HOLDINGS, S.L.	94
525201	09/09/2022	RADIOMUSIC	38 (Concedida) y 9 (Concedida)	ALBERTO MARTIN SCASSO VOLONTE	
525203	09/09/2022	UFINET	38 (Concedida S/D)	Ufinet Latam, S.L.	194
525205	09/09/2022	LIONARD (mixta)	36 (Concedida S/D)	LIONARD S.P.A.	245
525206	09/09/2022	BIOPOLY (mixta)	21 (Concedida) y 16 (Concedida)	VERDESIERRA URUGUAY S.R.L.	194
525208	09/09/2022	RE R MODA RESPONSABLE (mixta)	35 (Concedida), 25 (Concedida), 18	LOJAS RENNER S.A.	34

N° Exp	Resolución	Marca	Clases	Titular	Ag.
			(Concedida S/D), 14 (Concedida S/D) y 3 (Concedida S/D)		
525210	09/09/2022	SANTANDER X (mixta)	41 (Concedida S/D), 36 (Concedida S/D), 35 (Concedida S/D) y 9 (Concedida S/D)	SANTANDER INVESTMENT BANK LIMITED	194
525211	09/09/2022	B BARACUTA (mixta)	25 (Concedida S/D) y 18 (Concedida S/D)	G. & G. S.r.l	34
525213	09/09/2022	FURIA (mixta)	35 (Concedida S/D)	FURIA S.A.	34
525215	09/09/2022	BARACUTA	25 (Concedida S/D) y 18 (Concedida S/D)	G. & G. S.r.l.	34
525216	09/09/2022	G9	25 (Concedida S/D) y 18 (Concedida S/D)	G. & G. S.r.l.	34
525219	09/09/2022	SUMMIT	30 (Concedida S/D) y 4 (Concedida S/D)	AB Mauri (UK) Limited	34
525220	09/09/2022	JEAN PAUL GAULTIER "LA BELLE" (mixta)	3 (Concedida S/D)	PUIG FRANCE (A French société par actions simplifiée)	34
525221	09/09/2022	GREENPACK SUZANO (mixta)	16 (Concedida S/D)	SUZANO S.A.	34
525226	09/09/2022	COPACABANA	25 (Concedida S/D)	GRENDENE S.A.	220
525236	09/09/2022	RUKY	41 (Concedida) y 35 (Concedida)	Fondation Forge Uruguay	220
525237	09/09/2022	BUENVIVIR (mixta)	41 (Concedida) y 38 (Concedida)	DEMICHELIS SERRA LUCIA MARIA Y GARCIA RODRIGUEZ MARIA GRACIELA SOCIEDAD DE HECHO	
525238	21/09/2022	COMUNICARE APARELHOS AUDITIVOS (mixta)	37 (Concedida S/D), 35 (Concedida S/D) y 10 (Concedida	COMUNICARE COMERCIO DE APARELHOS AUDITIVOS LTDA	220

N° Exp	Resolución	Marca	Clases	Titular	Ag.
			S/D)		
525244	09/09/2022	LA DOMENICA	30 (Concedida)	MIGUEL PARADISO MANENTE y CAROLINA PARADISO MANENTE	
525247	09/09/2022	FRIGORIFICO PASO DE LOS TOROS (mixta)	40 (Concedida) y 29 (Concedida)	BAMIDAL S.A.	168
525248	09/09/2022	JM	2 (Concedida S/D)	RESINAS INDUSTRIALES S.A.	
525250	09/09/2022	ROCK & ROCK	19 (Concedida S/D)	TILES INVESTMENTS AND HOLDINGS, S.L.	94
525251	09/09/2022	ROCK & ROCK (mixta)	19 (Concedida S/D)	TILES INVESTMENTS AND HOLDINGS, S.L.	94
525252	09/09/2022	MR.PATRÓN (mixta)	25 (Concedida)	Maria Silva	
525254	09/09/2022	FLEXTEM BIOPHARMA (mixta)	44 (Concedida), 42 (Concedida) y 5 (Concedida)	RECOWEN S.A.	144
525260	09/09/2022	O ENSO (mixta)	18 (Concedida S/D)	JOUMMA BAGS, S.L.	144
525262	09/09/2022	SMALL DECO (mixta)	35 (Concedida), 21 (Concedida) y 20 (Concedida)	MARIA GUILLERMINA LORENZO SANCHEZ	
525272	09/09/2022	ESTACIÓN HOGAR (mixta)	35 (Concedida)	CARLOS ENRIQUE GONZALEZ SOSA	186
525276	09/09/2022	VIEJO CIPRES (mixta)	35 (Concedida) y 20 (Concedida)	ARMAND-UGON GARESE, ANA INÉS	245
525284	09/09/2022	AQUOS	5 (Concedida)	FEMADIL S.A.	201
525289	09/09/2022	PANTENE PRO-V COLÁGENO NUTRE Y REVITALIZA	3 (Concedida S/D)	The Procter & Gamble Company	212
525293	09/09/2022	PANTALLA URUGUAY (mixta)	35 (Concedida)	PANTALLAS URUGUAY S.A.	179
525300	30/09/2022	SPOOL	25 (Concedida S/D)	Domingo Torre y Cia. Ltda.	
525303	09/09/2022	LC LA CUEVA MUEBLES ® "TODO LO QUE BUSCAS PARA TU HOGAR" (mixta)	35 (Concedida S/D) y 20 (Concedida S/D)	LA CUEVA MUBLES S.R.L.	
525304	19/09/2022	DÓNDE IMPRIMIR FOTOS UY (mixta)	16 (Concedida)	Tisur Ltda.	
525306	09/09/2022	ARBOLDEMENTA	18 (Concedida S/D)	Victoria de León	
525311	09/09/2022	NOTABLE (mixta)	35 (Concedida)	STEIN LEV, FELIPE	201

N° Exp	Resolución	Marca	Clases	Titular	Ag.
525318	09/09/2022	KIRSTY	5 (Concedida S/D)	Mylan Pharmaceuticals, Inc.	194
525320	30/09/2022	FONROCHE	42 (Concedida S/D), 37 (Concedida S/D), 11 (Concedida S/D) y 9 (Concedida S/D)	FONROCHE LIGHTING	144
525325	09/09/2022	PORTERHOUSE	35 (Concedida)	juan farina	
525330	19/09/2022	THE BAR (mixta)	35 (Concedida)	ROTONDARO OLIVERA, ANGEL FABIO	201
525332	19/09/2022	OVINOSUY	35 (Concedida) y 9 (Concedida)	Jorge Pablo Gonzalez Lopez	
525339	19/09/2022	POWER ACTION (mixta)	7 (Concedida S/D)	NINGBO HAISHU JINPU IMPORT & EXPORT CO.,LTD.	144
525346	19/09/2022	BEN & JERRY'S (mixta)	30 (Concedida S/D)	Unilever IP Holdings B.V.	136
525352	19/09/2022	KNORR QUICK	29 (Concedida S/D)	KNORR-NÄHRMITTEL AKTIENGESELLSCHAFT	136
525356	19/09/2022	WILD RIFT	41 (Concedida S/D), 38 (Concedida S/D), 25 (Concedida S/D) y 9 (Concedida S/D)	Riot Games, Inc.	136
525358	19/09/2022	AMBAR (mixta)	5 (Concedida S/D)	SPEFAR S.A.	144
525363	19/09/2022	LARES DE VIRARO SOLYMAR (mixta)	37 (Concedida)	Andrés Nicolas Regueira Costa y Daniel Regueira Costa	232
525366	19/09/2022	ADRIANUZCA'S CAT CAFÉ (mixta)	43 (Concedida S/D) y 30 (Concedida S/D)	ADRIANA GISSEL BADIOLA OLAZA	
525367	19/09/2022	PIÑATEX	25 (Concedida S/D) y 18 (Concedida S/D)	Ananas Anam UK Limited	201
525368	19/09/2022	CAMPO LONGLEY URUGUAY (mixta)	32 (Concedida S/D), 30 (Concedida S/D) y 29 (Concedida S/D)	Topilen S.A	212

N° Exp	Resolución	Marca	Clases	Titular	Ag.
525369	19/09/2022	LATAM, SIN FRONTERAS	39 (Concedida)	LATAM Airlines Group S.A.	201
525373	19/09/2022	VIVIENDAS PARANÁ	37 (Concedida) y 19 (Concedida)	LIDERIAX SOCIEDAD ANÓNIMA	189
525374	19/09/2022	POMPA SHAPEWEAR (mixta)	35 (Concedida) y 25 (Concedida)	ROSES BENTANCOR, GABRIELA y LABORDE STORACE, MARIA CLARA	201
525377	19/09/2022	HAPPY MEAL	16 (Concedida)	McDonald's Corporation	186
525378	19/09/2022	CAJITA FELIZ	16 (Concedida)	McDonald's Corporation	186
525382	19/09/2022	MOSCALAB (mixta)	41 (Concedida)	Mosca Hnos. S.A.	192
525388	19/09/2022	VIQUA (mixta)	11 (Concedida S/D)	VIQUA INDÚSTRIA DE PLÁSTICOS LTDA	194
525389	19/09/2022	DIGESSE	1 (Concedida S/D)	LESAFFRE ET COMPAGNIE	144
525391	19/09/2022	(figurativa)	42 (Concedida S/D), 41 (Concedida S/D) y 9 (Concedida S/D)	Wikimedia Foundation, Inc.	192
525397	19/09/2022	COLORTREND	2 (Concedida S/D)	CHROMAFLO TECHNOLOGIES CORPORATION	34
525399	19/09/2022	PLASTICOLORS	2 (Concedida S/D) y 1 (Concedida S/D)	CHROMAFLO TECHNOLOGIES CORPORATION	34
525402	09/09/2022	MPRENDE (mixta)	39 (Concedida) y 35 (Concedida)	Mauricio Braica Alcalde; Nicolás Guggeri y Fabián Rial	212
525405	09/09/2022	NEXA	42 (Concedida S/D), 37 (Concedida S/D) y 36 (Concedida S/D)	VERDHE DESARROLLOS SAS	
525407	09/09/2022	AGROMAQ (mixta)	35 (Concedida), 12 (Concedida) y 7 (Concedida)	Mauricio Viera Gambetta	245
525410	09/09/2022	DISUR	35 (Concedida) y 3 (Concedida)	RODRIGUEZ, GUSTAVO	189
525412	09/09/2022	BRAGO (mixta)	35 (Concedida)	Germán Augusto Fraschini Rantighieri	
525413	09/09/2022	MODERNA PROPIEDADES	36 (Concedida S/D)	Laura Melgar	
525415	19/09/2022	ROND PUÁN	35 (Concedida) y 25	GABRIELLI SAMURIO FLORENCIA MARIA	212

N° Exp	Resolución	Marca	Clases	Titular	Ag.
			(Concedida)		
525417	19/09/2022	GREENOVATION	12 (Concedida S/D)	Opel Automobile GmbH	194
525420	19/09/2022	GOAT	25 (Concedida S/D)	1661, Inc.	194
525422	19/09/2022	CARELIFE INNOVATIVE SOLUTIONS (mixta)	35 (Concedida), 11 (Concedida) y 10 (Concedida)	Fernando Javier Caballero De Luis	
525425	19/09/2022	COSTUMBRES AL PASO (mixta)	43 (Concedida), 35 (Concedida) y 30 (Concedida)	VIDELA, LUIS	201
525426	19/09/2022	SOLARIUM (mixta)	37 (Concedida), 35 (Concedida) y 19 (Concedida)	BAZUL S.A.	94
525429	19/09/2022	HAIR SHOP TIENDA PARA ESTILISTAS (mixta)	35 (Concedida)	Noelia Crosi Perdomo	179
525431	19/09/2022	SECURITY FILM SEGURIDAD GARANTIZADA (mixta)	35 (Concedida S/D) y 17 (Concedida S/D)	Axel Troisi	
525434	19/09/2022	LYCAN	20 (Concedida S/D) y 11 (Concedida S/D)	HONGKONG DINGXIN INDUSTRY AND TRADE LIMITED	201
525436	19/09/2022	TRABI (mixta)	16 (Concedida)	Carti S.A.	240
525445	19/09/2022	TEIPE (mixta)	17 (Concedida S/D)	PTKDELECUADOR S.A.	144
525446	19/09/2022	NATUREFLEX	16 (Concedida S/D)	Futamura Chemical UK Ltd	144
525448	19/09/2022	KINZBIO	5 (Concedida)	ASINDAL S.A.S.	201
525451	19/09/2022	FIAT FASTBACK (mixta)	12 (Concedida S/D)	FCA GROUP MARKETING S.P.A.	212
525454	30/09/2022	PABLO ARENAS NEGOCIOS INMOBILIARIOS (mixta)	36 (Concedida S/D)	Pablo Arenas	
525455	19/09/2022	JARDÍN COMPOSTELA VIVERO BOUTIQUE (mixta)	44 (Concedida) y 35 (Concedida)	PEREZ PIÑEYRO MARIA ADELAIDA	212
525456	19/09/2022	ADRA	44 (Concedida S/D) y 43 (Concedida)	Adventist Development and Relief Agency International	245

N° Exp	Resolución	Marca	Clases	Titular	Ag.
			S/D)		
525457	19/09/2022	FIAT PULSE (mixta)	12 (Concedida S/D)	FCA GROUP MARKETING S.P.A.	212
525460	19/09/2022	SHAWARMA ESTACION SOLGER EL PRIMERO ..EL ORIGINAL.!! (mixta)	43 (Concedida)	VARELA, GERARDO y OTERO, SOLANGE	201
525462	19/09/2022	ESENCIAS DE GARZÓN (mixta)	3 (Concedida)	MACHADO DE LEON DIEGO ARMANDO Y MANGANIEL GOMEZ CLAUDIA LUCIA SOCIEDAD DE HECHO	220
525465	19/09/2022	BRONPI (mixta)	35 (Concedida S/D) y 11 (Concedida S/D)	BRONPI CALEFACCIÓN, S.L.	216
525467	19/09/2022	PUNTOS VERDES	36 (Concedida)	FUCAC VERDE COOPERATIVA DE AHORRO Y CREDITO	201
525468	19/09/2022	VERDE.COOP	36 (Concedida)	FUCAC VERDE COOPERATIVA DE AHORRO Y CREDITO	201
525469	19/09/2022	VIVEO	3 (Concedida S/D)	CM HOSPITALAR S.A.	212
525470	19/09/2022	(figurativa)	5 (Concedida S/D)	NOVARTIS AG.	201
525473	19/09/2022	TERRE AGRO SUSTENTABLE (mixta)	44 (Concedida), 39 (Concedida), 35 (Concedida), 12 (Concedida), 7 (Concedida), 2 (Concedida) y 1 (Concedida)	AF Global S.R.L.	
525476	19/09/2022	TERRE AGRO SUSTENTABLE (mixta)	5 (Concedida S/D)	AF Global S.R.L.	
525477	19/09/2022	VIVEO	5 (Concedida S/D)	CM HOSPITALAR S.A.	212
525478	19/09/2022	LITTLE MIC (mixta)	35 (Concedida S/D)	MAQUILA INTERNACIONAL DE CONFECCIÓN S.A.S	212
525479	19/09/2022	VIVEO	9 (Concedida S/D)	CM HOSPITALAR S.A.	212
525505	12/09/2022	NVL	42 (Concedida S/D), 41 (Concedida S/D),	NVL B.V. & Co. KG	144

N° Exp	Resolución	Marca	Clases	Titular	Ag.
			37 (Concedida S/D) y 12 (Concedida S/D)		
525506	15/09/2022	STOP RESPIRÁ - ENFOCATE - DISFRUTÁ (mixta)	41 (Concedida S/D), 28 (Concedida S/D) y 16 (Concedida S/D)	Lucia Virginia Mendez Bomio	
525507	15/09/2022	B BAMBARY (mixta)	35 (Concedida S/D) y 16 (Concedida S/D)	Bambary Corp	201
525508	16/09/2022	CALMEVA (mixta)	5 (Concedida S/D) y 3 (Concedida)	INSTITUTO BIOLOGICO ARGENTINO S.A.I.C.	219
525509	26/09/2022	MAGNA MOTORS (mixta)	12 (Concedida S/D)	AUTOMOTORES MOTOR HAUS, SA	94
525511	15/09/2022	PLAZARURAL (mixta)	36 (Concedida) y 35 (Concedida)	Sitio Rural S.A.	144
525512	15/09/2022	MELOUT (mixta)	5 (Concedida S/D)	INSTITUTO BIOLOGICO ARGENTINO S.A.I.C.	219
525513	16/09/2022	PRECIO JUSTO (mixta)	36 (Concedida) y 35 (Concedida)	Sitio Rural S.A.	144
525514	15/09/2022	MIC (mixta)	35 (Concedida S/D)	MAQUILA INTERNACIONAL DE CONFECCIÓN S.A.S	212
525515	15/09/2022	MAGNA MOTORS (mixta)	35 (Concedida)	AUTOMOTORES MOTOR HAUS, SA	94
525516	15/09/2022	GRUPEL ENERGY EVERYWHERE (mixta)	7 (Concedida S/D)	GRUPEL – GRUPOS ELECTROGENEOS, S.A.	144
525517	15/09/2022	VIVEO	10 (Concedida S/D)	CM HOSPITALAR S.A.	212
525520	15/09/2022	VIVEO	35 (Concedida S/D)	CM HOSPITALAR S.A.	212
525521	15/09/2022	VIVEO	39 (Concedida S/D)	CM HOSPITALAR S.A.	212
525522	15/09/2022	MASCOT	35 (Concedida S/D), 25 (Concedida S/D), 10 (Concedida S/D) y 9 (Concedida S/D)	MASCOT INTERNATIONAL A/S	212

N° Exp	Resolución	Marca	Clases	Titular	Ag.
525523	15/09/2022	VIVEO	44 (Concedida S/D)	CM HOSPITALAR S.A.	212
525524	16/09/2022	TALLERES AGP TRAYECTORIA EN CHAPA Y PINTURA (mixta)	37 (Concedida)	GOMEZ PEREYRA ALEJANDRO	232
525528	15/09/2022	HELI-C (mixta)	25 (Concedida S/D)	Etoile S.R.L.	
525533	15/09/2022	ADP ESTUDIO JURIDICO (mixta)	45 (Concedida)	BEATRIZ DEL PRESTITO	
525534	15/09/2022	RINCÓN NUESTRO POPULAR	43 (Concedida)	CAPRICHOSA S.A.S.	179
525536	15/09/2022	VIVÍ TU PELO A FULL FULL COLOR PROFESSIONAL VIVÍ TU PELO A FULL (mixta)	3 (Concedida)	LLANES BENTANCOR MAURICIO ANDRES	220
525538	15/09/2022	GOLDENBIKE	37 (Concedida) y 35 (Concedida)	GOLDEN BIKE SRL	218
525553	16/09/2022	ARAPEY THERMAL RESORT & SPA (mixta)	44 (Concedida), 43 (Concedida) y 41 (Concedida)	BILDESOL S.A.	201
525554	15/09/2022	MOVIES (mixta)	25 (Concedida S/D)	MAQUILA INTERNACIONAL DE CONFECCIÓN S.A.S	212
525555	16/09/2022	COMPOST CIUDADANO (mixta)	40 (Concedida)	ALBA PEREIRA ANDREA PAOLA Y LUISI CETRARO FEDERICO DAMIAN SOCIEDAD DE HECHO	
525556	15/09/2022	MOVIES (mixta)	35 (Concedida S/D)	MAQUILA INTERNACIONAL DE CONFECCIÓN S.A.S	212
525558	16/09/2022	SPINUP MINDFUL & FIT (mixta)	41 (Concedida)	Lorna Valeria Yelpe Dobalo	215
525559	16/09/2022	LIFEBUOY (mixta)	5 (Concedida S/D) y 3 (Concedida S/D)	Unilever Global IP Limited	136
525562	30/09/2022	C REPRODUCIENDO VALOR (mixta)	41 (Concedida S/D) y 5 (Concedida S/D)	LABORATORIOS CALIER, S.A.	94
525564	15/09/2022	BAIDEWEY (mixta)	43 (Concedida S/D)	ADRIANA DEL VALLE GARCIA GUIÑAN	
525565	15/09/2022	(figurativa)	44 (Concedida S/D), 42 (Concedida S/D), 41 (Concedida S/D), 36 (Concedida S/D),	UPL Corporation Limited	144

N° Exp	Resolución	Marca	Clases	Titular	Ag.
			35 (Concedida S/D), 31 (Concedida S/D), 5 (Concedida S/D) y 1 (Concedida S/D)		
525568	15/09/2022	(figurativa)	44 (Concedida S/D), 42 (Concedida S/D), 41 (Concedida S/D), 36 (Concedida S/D), 35 (Concedida S/D), 31 (Concedida S/D), 5 (Concedida S/D) y 1 (Concedida S/D)	UPL Corporation Limited	144
525571	15/09/2022	SUBLIME SOLUTIONS	38 (Concedida) y 35 (Concedida)	Luis Rinaldi	
525573	15/09/2022	TERRA	21 (Concedida S/D)	JULIETA VERDIE	
525575	15/09/2022	ZOJIRUSHI (mixta)	21 (Concedida S/D)	ZOJIRUSHI CORPORATION	216
525579	15/09/2022	PARKONE	39 (Concedida S/D)	Héctor Leonardo Traversa Gorgoroso	
525580	15/09/2022	(figurativa)	30 (Concedida S/D)	A. LOACKER - S.P.A.	219
525583	15/09/2022	AMC + (mixta)	38 (Concedida S/D) y 9 (Concedida S/D)	AMC NETWORK ENTERTAINMENT LLC	194
525585	15/09/2022	GUIDETRACK	10 (Concedida)	Cardinal Health 529, LLC	194
525586	15/09/2022	AMERICAS 1 (mixta)	37 (Concedida)	DOTRAX UNO SAS	34
525589	15/09/2022	FLO BEAUTY BELLEZA INTELIGENTE (mixta)	35 (Concedida) y 3 (Concedida)	VELASIN S.A.	216
525590	15/09/2022	SUPER MATCH APUESTAS DEPORTIVAS (mixta)	41 (Concedida S/D), 28 (Concedida S/D) y 9 (Concedida S/D)	BANCA DE CUBIERTA COLECTIVA DE QUINIELAS DE MONTEVIDEO	245
525591	15/09/2022	AVELINA	30 (Concedida S/D)	GRUPO AVELINA INTERNACIONAL S.A	212
525594	16/09/2022	DOVE BODY LOVE (mixta)	3 (Concedida S/D)	Unilever Global IP Limited	136
525605	27/09/2022	WOFE URUGUAY FEDERACION NACIONAL DE BUSQUEDA,	35 (Concedida)	Yamandú Alfredo Malates	

N° Exp	Resolución	Marca	Clases	Titular	Ag.
		RESCATE Y SOCORRISMO K9 (mixta)			
525610	13/09/2022	GADOSUPRIN	5 (Concedida)	Laboratorio GADOR S.A.	165
525614	13/09/2022	FORSIL ICLOS	5 (Concedida)	Mega Labs S.A.	144
525622	13/09/2022	VOLCON	12 (Concedida S/D)	Volcon, Inc	186
525624	13/09/2022	GRUNT	12 (Concedida S/D)	Volcon, Inc	186
525628	13/09/2022	RAPILOG	10 (Concedida S/D) y 5 (Concedida S/D)	Biocon Biologics Limited	205
525629	15/09/2022	RAPILOG ONE	10 (Concedida S/D) y 5 (Concedida S/D)	Biocon Biologics Limited	205
525630	16/09/2022	OUT OF THE BOX (mixta)	41 (Concedida) y 28 (Concedida)	AGUSTÍN PÁEZ y ELISA KSIAZENICKI	
525635	13/09/2022	ÑANDÚ	28 (Concedida S/D)	Bruno Carrea	212
525636	13/09/2022	PATAPUF	28 (Concedida S/D)	Manuela Morales	
525641	13/09/2022	INTILAC	3 (Concedida)	Gramón Bagó de Uruguay S.A.	181
525642	16/09/2022	BUFF	25 (Concedida S/D)	ORIGINAL BUFF S.A.	144
525643	16/09/2022	ALTIVITY GADOPICLENOL (mixta)	5 (Concedida S/D)	GUERBET	144
525644	13/09/2022	NOT (mixta)	32 (Concedida), 30 (Concedida) y 29 (Concedida)	The Not Company SpA	144
525645	13/09/2022	X NOTCO NOT MILK	29 (Concedida S/D)	The Not Company SpA	144
525646	21/09/2022	SILVER FREIGHT URUGUAY (mixta)	39 (Concedida)	SILVER SHIPPING GROUP S.A.	215
525647	26/09/2022	RISEN (mixta)	35 (Concedida S/D)	Risen Energy Co., Ltd	144
525649	20/09/2022	SILVER FREIGHT LOGISTIC (mixta)	39 (Concedida)	SILVER SHIPPING GROUP S.A.	215
525650	20/09/2022	BUSINESSKIDS (mixta)	41 (Concedida S/D)	Comercio Internacional Mexicano S.A. de C.V	212
525651	13/09/2022	MONKS	42 (Concedida S/D), 41 (Concedida S/D), 38 (Concedida S/D), 35 (Concedida S/D), 16 (Concedida S/D) y 9 (Concedida S/D)	MediaMonks Multimedia Holding B.V.	136

N° Exp	Resolución	Marca	Clases	Titular	Ag.
525652	20/09/2022	SILVER SHIPPING GROUP (mixta)	39 (Concedida)	SILVER SHIPPING GROUP S.A.	215
525658	16/09/2022	GLASSY WAVES (mixta)	39 (Concedida), 28 (Concedida) y 25 (Concedida)	ROCHA CESAR, JAVIER ANDRES	201
525659	13/09/2022	KOF	42 (Concedida S/D), 38 (Concedida S/D), 35 (Concedida S/D) y 9 (Concedida S/D)	Coca-Cola FEMSA, S.A.B. de C.V.	216
525660	13/09/2022	KOF.COM	42 (Concedida S/D), 38 (Concedida S/D), 35 (Concedida S/D) y 9 (Concedida S/D)	Coca-Cola FEMSA, S.A.B. de C.V.	216
525662	13/09/2022	NUTENTA (mixta)	42 (Concedida S/D), 38 (Concedida S/D), 35 (Concedida S/D) y 9 (Concedida S/D)	Coca-Cola FEMSA, S.A.B. de C.V.	216
525664	13/09/2022	NUTENTA.COM (mixta)	42 (Concedida S/D), 38 (Concedida S/D), 35 (Concedida S/D) y 9 (Concedida S/D)	Coca-Cola FEMSA, S.A.B. de C.V.	216
525665	26/09/2022	FROM ILLUMINATION* *THE STUDIO THAT BROUGHT YOU DESPICABLE ME, THE SECRET LIFE OF PETS, SING & MINIONS (mixta)	28 (Concedida) y 25 (Concedida)	UNIVERSAL CITY STUDIOS LLC	94
525668	16/09/2022	(figurativa)	45 (Concedida S/D), 43 (Concedida S/D), 42 (Concedida S/D), 41 (Concedida S/D), 40 (Concedida S/D), 39 (Concedida S/D),	TotalEnergies SE	201

N° Exp	Resolución	Marca	Clases	Titular	Ag.
			38 (Concedida S/D), 37 (Concedida S/D), 36 (Concedida S/D), 35 (Concedida S/D), 28 (Concedida S/D), 25 (Concedida S/D), 21 (Concedida S/D), 20 (Concedida S/D), 19 (Concedida S/D), 18 (Concedida S/D), 17 (Concedida S/D), 16 (Concedida S/D), 14 (Concedida S/D), 12 (Concedida S/D), 11 (Concedida S/D), 9 (Concedida S/D), 7 (Concedida S/D), 6 (Concedida S/D), 5 (Concedida S/D), 4 (Concedida S/D), 3 (Concedida S/D), 2 (Concedida S/D) y 1 (Concedida S/D)		
525669	27/09/2022	REDMI (mixta)	45 (Concedida), 42 (Concedida), 41 (Concedida), 39 (Concedida), 38 (Concedida), 37 (Concedida), 36 (Concedida), 35 (Concedida), 25 (Concedida)	XIAOMI INC.	34

N° Exp	Resolución	Marca	Clases	Titular	Ag.
			(Concedida), 15 (Concedida), 11 (Concedida), 10 (Concedida), 9 (Concedida), 7 (Concedida), 3 (Concedida) y 2 (Concedida)		
525670	13/09/2022	NORTHELIS	41 (Concedida) y 35 (Concedida)	ANA VALERIA DUARTE BOGADJIAN	212
525673	13/09/2022	MIUI (mixta)	42 (Concedida), 35 (Concedida), 12 (Concedida), 11 (Concedida), 9 (Concedida) y 7 (Concedida)	XIAOMI INC.	34
525675	13/09/2022	ARACAR GROUP (mixta)	36 (Concedida)	Uruguay Aracar SAS	172
525676	13/09/2022	ARACARD	36 (Concedida)	Uruguay Aracar SAS	172
525677	20/09/2022	CASA & LIVING (mixta)	35 (Concedida), 27 (Concedida), 24 (Concedida) y 21 (Concedida)	UNILAM S.A	212
525685	13/09/2022	VEGURT	29 (Concedida S/D)	ADRIANA DEL VALLE GARCIA GUIÑAN	
525691	16/09/2022	C&H BEAUTE	5 (Concedida) y 3 (Concedida)	LABORATORIOS CAILLON & HAMONET S.A.C.I.	201
525700	15/09/2022	AMORARMA (mixta)	3 (Concedida)	IMPORT EXPORT KIENKO CHILE LTDA	179
525701	15/09/2022	CINDISAMI (mixta)	3 (Concedida)	IMPORT EXPORT KIENKO CHILE LTDA.	179
525703	16/09/2022	NEEDFEEL (mixta)	3 (Concedida)	IMPORT EXPORT KIENKO CHILE LTDA.	179
525704	15/09/2022	WOVISNI (mixta)	3 (Concedida)	IMPORT EXPORT KIENKO CHILE LTDA.	179
525707	21/09/2022	PLANT PLUS FOODS (mixta)	30 (Concedida S/D) y 29 (Concedida)	MARFRIG GLOBAL FOODS S.A.	144

N° Exp	Resolución	Marca	Clases	Titular	Ag.
			S/D)		
525708	16/09/2022	PERVIRAL SPRAY	5 (Concedida S/D)	LABORATORIO ELEA PHOENIX S.A.	34
525711	16/09/2022	TRESLUCE	3 (Concedida S/D)	Latin Beauty Perspectives, LLC	94
525714	21/09/2022	CALDO BORDELES VALLES	5 (Concedida)	Industrias Químicas del Valles S.A.	101
525716	15/09/2022	IBG (mixta)	42 (Concedida), 40 (Concedida), 37 (Concedida), 12 (Concedida), 11 (Concedida), 8 (Concedida), 7 (Concedida) y 6 (Concedida)	NESTOR MANSILLA	212
525721	16/09/2022	ZAMISINDY (mixta)	3 (Concedida)	IMPORT EXPORT KIENKO CHILE LTDA.	179
525723	16/09/2022	META SPORTS (mixta)	38 (Concedida)	Verlin Gale Ray Jr	212
525724	21/09/2022	ESTETIC LIFE (mixta)	44 (Concedida S/D)	Andrea Wezranovski de Mello	
525726	15/09/2022	PROTEA	25 (Concedida)	Brenda Rígoli	
525728	16/09/2022	RAINBOW	12 (Concedida)	Uriel Barenstein	
525730	21/09/2022	LA PLANTA FILMS	41 (Concedida) y 35 (Concedida)	PIXART LTDA.	
525733	16/09/2022	METROID	9 (Concedida S/D)	Nintendo of America Inc.	136
525734	16/09/2022	TCL (mixta)	3 (Concedida)	THE CHEMIST LOOK LLC	144
525736	21/09/2022	(figurativa)	43 (Concedida S/D), 39 (Concedida S/D), 33 (Concedida S/D), 32 (Concedida S/D), 31 (Concedida S/D), 30 (Concedida S/D), 29 (Concedida S/D), 28 (Concedida S/D), 27 (Concedida S/D), 26 (Concedida S/D),	Bytedance Ltd.	144

N° Exp	Resolución	Marca	Clases	Titular	Ag.
			25 (Concedida S/D), 24 (Concedida S/D), 21 (Concedida S/D), 20 (Concedida S/D), 18 (Concedida S/D), 16 (Concedida S/D), 14 (Concedida S/D), 11 (Concedida S/D), 10 (Concedida S/D), 8 (Concedida S/D), 6 (Concedida S/D) y 3 (Concedida S/D)		
525738	16/09/2022	PLYM (mixta)	30 (Concedida)	Panificadora Bimbo del Uruguay S.A.	181
525739	16/09/2022	PLUCKY (mixta)	30 (Concedida)	Panificadora Bimbo del Uruguay S.A.	181
525742	16/09/2022	PLUM	28 (Concedida S/D)	Plum Products Holdings Pty Ltd.	212
525745	21/09/2022	LUMINOS IMPULSE	10 (Concedida S/D)	Siemens Healthcare GmbH	219
525756	16/09/2022	OMODA (mixta)	12 (Concedida)	Chery Automobile Co., Ltd.	218
525758	21/09/2022	PACTO SUSTENTABLE (mixta)	25 (Concedida)	ZALDIVAR MARIA LAURA	34
525761	21/09/2022	HUMANIN HAUS	41 (Concedida S/D)	COMUNIDAD HUMANIN S.L.	34
525765	16/09/2022	AJAX (mixta)	9 (Concedida S/D)	AJAX SYSTEMS CYPRUS HOLDINGS LTD.	34
525767	21/09/2022	THE BOTANIST EARTHWISE	3 (Concedida S/D)	4E GLOBAL S.A.P.I. DE C.V	34
525769	16/09/2022	FENEDUR	35 (Concedida), 16 (Concedida) y 1 (Concedida)	Fenedur S.A	240
525770	16/09/2022	FENEDUR S.A.	35 (Concedida), 16 (Concedida) y 1 (Concedida)	Fenedur S.A.	240
525771	30/09/2022	SIMPLIFICADO	45 (Concedida S/D), 42 (Concedida S/D) y 9 (Concedida S/D)	BANTRAINING LTDA	
525773	21/09/2022	SHEN MA (mixta)	1 (Concedida S/D)	China Pingmei Shenma Energy and Chemical	220

N° Exp	Resolución	Marca	Clases	Titular	Ag.
				Group Co., Ltd	
525774	16/09/2022	LA RECORRE (mixta)	39 (Concedida) y 30 (Concedida)	FERNANDEZ SETARO EUGENIO GASTON Y MATEO COIRO ANACLARA SOCIEDAD DE HECHO	220
525778	21/09/2022	LACTEOS NARBONA 1909 (mixta)	35 (Concedida), 30 (Concedida) y 29 (Concedida S/D)	CANTON, EDUARDO y BANCHERO BANCHERO, MARIA JOSE	245
525780	21/09/2022	ELIXIA MEDICINA ESTÉTICA (mixta)	44 (Concedida)	SEVERO PEREZ VERONICA YANET	220
525781	21/09/2022	COMO PANCHO POR SU CASA (mixta)	43 (Concedida)	Matías Delfino y Nicolás Rodríguez	
525782	16/09/2022	REGALANA	25 (Concedida)	Gabriela Rodriguez	212
525783	21/09/2022	(tridimensional)	32 (Concedida)	PABEWIL SOCIEDAD ANÓNIMA	189
525784	21/09/2022	DERMOHEMP (mixta)	5 (Concedida S/D) y 3 (Concedida S/D)	CRYSTAL HEMP SA	156
525786	16/09/2022	ULTA	35 (Concedida S/D) y 3 (Concedida S/D)	ULTA BEAUTY, INC.	212
525787	16/09/2022	PLANTB (mixta)	30 (Concedida S/D) y 29 (Concedida S/D)	MARTIN LOPEZ GAMBETTA	
525788	21/09/2022	ULTA BEAUTY	35 (Concedida S/D) y 3 (Concedida S/D)	ULTA BEAUTY, INC.	212
525791	16/09/2022	KANSACO (mixta)	4 (Concedida)	Kansaco Petroquímica S.A.	212
525792	26/09/2022	FARMAEXPRESS TU SALUD, SIEMPRE DE TURNO (mixta)	39 (Concedida) y 35 (Concedida)	NALTILEX S A	220
525794	16/09/2022	BYNNEK (mixta)	42 (Concedida S/D), 10 (Concedida S/D) y 9 (Concedida S/D)	Maite Beathyate	
525796	21/09/2022	TRIUNFA EMPRENDIENDO	41 (Concedida S/D)	María Noel Artave	
525799	21/09/2022	MUNDO ANIMAL	43 (Concedida S/D)	M&A FRANCHISING LTDA	234
525802	19/09/2022	URBAN DEFENSE	3 (Concedida S/D)	L'OREAL	144

N° Exp	Resolución	Marca	Clases	Titular	Ag.
525804	19/09/2022	THE CHEMIST LOOK (mixta)	3 (Concedida)	THE CHEMIST LOOK LLC	144
525805	19/09/2022	DEER (mixta)	19 (Concedida S/D)	Shunzhi Nan	144
525806	19/09/2022	RUTA 1 POLO LOGÍSTICO (mixta)	39 (Concedida)	CELERES SA	144
525808	30/09/2022	ADDERS LEGAL & BUSINESS STRATEGY (mixta)	45 (Concedida)	Menghi Arburuas Juan, Orrico Campopiano Nicolás y Fariña Carreras, Mathias	181
525809	19/09/2022	PROVET LABORATORIOS PROVET (mixta)	5 (Concedida S/D)	LABORATORIOS PROVET S.A.S	94
525810	30/09/2022	GAUCHO'S CHOICE (mixta)	30 (Concedida S/D), 29 (Concedida S/D) y 4 (Concedida S/D)	INDEX NEGÓCIOS INTERNACIONAIS EIRELI	34
525812	19/09/2022	CROWNMAN (mixta)	9 (Concedida S/D) y 8 (Concedida S/D)	ZHANGJIAGANG PRIMWELL IMP. & EXP. CO., LTD.	34
525813	19/09/2022	(figurativa)	35 (Concedida), 31 (Concedida) y 1 (Concedida)	APATIT	34
525816	19/09/2022	EMPARHELADO	30 (Concedida S/D)	Diego Suárez	
525818	21/09/2022	GLACÉ	30 (Concedida S/D)	Diego Suárez	
525820	21/09/2022	TT (mixta)	35 (Concedida S/D) y 3 (Concedida S/D)	River Light V, L.P.	212
525821	21/09/2022	URUCUEROS	35 (Concedida), 25 (Concedida) y 18 (Concedida)	Maria Lujan Sanabia Rodriguez	212
525824	21/09/2022	URUGUAY NOMÁ!!!	35 (Concedida)	Darío Santurio	212
525825	21/09/2022	FENEDUR (mixta)	35 (Concedida), 16 (Concedida) y 1 (Concedida)	Fenedur S.A.	240
525829	21/09/2022	ALMENDRA STORE (mixta)	25 (Concedida)	NILDA ROSANA BATISTA	212
525830	21/09/2022	CUSMED CENTRO URUGUAYO DE SIMULACIÓN MÉDICA (mixta)	42 (Concedida S/D) y 9 (Concedida S/D)	Maite Beathyate	
525831	21/09/2022	ALMENDRA STORE (mixta)	35 (Concedida)	NILDA ROSANA BATISTA	212
525833	21/09/2022	EVERGO (mixta)	37 (Concedida) y 9	INTERENERGY SYSTEMS DOMINICANA	

N° Exp	Resolución	Marca	Clases	Titular	Ag.
			(Concedida)	S.R.L.	
525840	21/09/2022	AMATISTA (mixta)	44 (Concedida)	DIAZ GONZALEZ KENIA MARILEISY Y LOPEZ MACEDO LUCIA YAMILA SOCIEDAD DE HECHO	
525842	21/09/2022	AMATISTA (mixta)	41 (Concedida)	DIAZ GONZALEZ KENIA MARILEISY Y LOPEZ MACEDO LUCIA YAMILA SOCIEDAD DE HECHO	
525844	26/09/2022	AUTHENTIFIELD	42 (Concedida S/D) y 9 (Concedida S/D)	NOVARTIS AG.	201
525849	21/09/2022	YETI	21 (Concedida S/D)	YETI Coolers, LLC	194
525851	26/09/2022	HUVEMYCIN	5 (Concedida S/D)	HUVEPHARMA EOOD	201
525852	26/09/2022	LAY'S RUSTICAS	29 (Concedida)	PEPSICO, INC.	201
525853	21/09/2022	NOT MILK (mixta)	32 (Concedida S/D) y 29 (Concedida S/D)	The Not Company SpA	144
525854	21/09/2022	NOT MAYO (mixta)	30 (Concedida S/D)	The Not Company SpA	144
525856	21/09/2022	VENTUS (mixta)	7 (Concedida S/D)	IMEGA VENTUS S.P.A.	144
525857	21/09/2022	VENTUS (mixta)	11 (Concedida S/D)	IMEGA VENTUS S.P.A.	144
525858	21/09/2022	VENTUS (mixta)	35 (Concedida S/D)	IMEGA VENTUS S.P.A.	144
525859	21/09/2022	LIBERO (mixta)	11 (Concedida S/D)	IMEGA VENTUS S.P.A.	144
525860	21/09/2022	BLANIK (mixta)	7 (Concedida S/D)	IMEGA VENTUS S.P.A.	144
525861	21/09/2022	BLANIK (mixta)	11 (Concedida S/D)	IMEGA VENTUS S.P.A.	144
525862	21/09/2022	BLANIK (mixta)	35 (Concedida S/D)	IMEGA VENTUS S.P.A.	144
525866	26/09/2022	NEURIMMUNE	5 (Concedida S/D)	Neurimmune Holding AG	136
525871	26/09/2022	AKLIEF (mixta)	5 (Concedida S/D) y 3 (Concedida S/D)	Galderma Holding S.A.	245
525872	30/09/2022	SMARTSOIL BY AMVAC (mixta)	5 (Concedida S/D)	AMVAC Hong Kong Ltd.	212
525873	30/09/2022	PCELREPARACIONES (mixta)	35 (Concedida)	Angel Leonel Cardozo Muniz	
525875	26/09/2022	AMBRA MULTI-TRACTION (mixta)	4 (Concedida S/D) y 1 (Concedida S/D)	Petroliam Nasional Berhad (PETRONAS)	144
525876	26/09/2022	FLOAT PARADISE (mixta)	43 (Concedida) y 41	DINAMIC CORP SAS	144

N° Exp	Resolución	Marca	Clases	Titular	Ag.
			(Concedida)		
525877	26/09/2022	IS EG HALAL (mixta)	42 (Concedida S/D)	IS EG HALAL CERTIFIED, INC. CORPORATION	144
525882	26/09/2022	RULA´S	18 (Concedida)	DAIANA DÍAZ GARCÍA	
525884	30/09/2022	TEST URUGUAY. (mixta)	44 (Concedida), 42 (Concedida), 39 (Concedida) y 35 (Concedida)	CAMARA URUGUAYA DE SOFTWARE	201
525886	26/09/2022	LEAGUE OF LEGENDS	6 (Concedida)	Riot Games, Inc.	136
525887	30/09/2022	LEAGUE OF LEGENDS	9 (Concedida S/D)	Riot Games, Inc.	136
525890	26/09/2022	LEAGUE OF LEGENDS	16 (Concedida)	Riot Games, Inc.	136
525891	26/09/2022	LEAGUE OF LEGENDS	18 (Concedida)	Riot Games, Inc.	136
525901	21/09/2022	LEAGUE OF LEGENDS	25 (Concedida)	Riot Games, Inc.	136
525904	21/09/2022	TRADON	5 (Concedida)	Craveri S.A.	144
525906	21/09/2022	LEAGUE OF LEGENDS	26 (Concedida)	Riot Games, Inc.	136
525907	21/09/2022	LEAGUE OF LEGENDS	28 (Concedida)	Riot Games, Inc.	136
525910	21/09/2022	LEAGUE OF LEGENDS	30 (Concedida)	Riot Games, Inc.	136
525912	21/09/2022	LEAGUE OF LEGENDS	32 (Concedida)	Riot Games, Inc.	136
525914	21/09/2022	AVON EVE	3 (Concedida S/D)	AVON PRODUCTS, INC.	194
525916	21/09/2022	LEAGUE OF LEGENDS	36 (Concedida)	Riot Games, Inc.	136
525917	21/09/2022	LEAGUE OF LEGENDS	38 (Concedida)	Riot Games, Inc.	136
525919	21/09/2022	LEAGUE OF LEGENDS	41 (Concedida)	Riot Games, Inc.	136
525920	21/09/2022	LEAGUE OF LEGENDS	42 (Concedida)	Riot Games, Inc.	136
525923	21/09/2022	LB DRA. LUCÍA BOLASCO (mixta)	44 (Concedida) y 41 (Concedida)	BOLASCO DE MIQUELERENA, LUCIA Y DA PRÁ BOLASCO, LUCIA	34
525924	21/09/2022	GRUPO BOLASCO ORTOPEDIA FUNCIONAL DE LOS MAXILARES (mixta)	44 (Concedida) y 41 (Concedida)	BOLASCO DE MIQUELERENA, LUCIA y DA PRÁ BOLASCO, LUCIA	34
525925	21/09/2022	HIDRA YOUNG	3 (Concedida)	Kiss Nail Products, Inc.	201
525933	26/09/2022	JACK BEER (mixta)	32 (Concedida S/D)	ODDONE MORALESHENRY JAVIER Y	

N° Exp	Resolución	Marca	Clases	Titular	Ag.
				ODDONE CEZAR SEBASTIAN JOSE SOCIEDAD DE HECHO.	
525934	21/09/2022	ÖLHUÉ	3 (Concedida S/D)	Macarena Cancela y Viviana Cancela	
525935	21/09/2022	SYMSITIVE	3 (Concedida S/D) y 1 (Concedida S/D)	Symrise AG	240
525938	21/09/2022	PRINTASTIC	42 (Concedida S/D), 39 (Concedida S/D) y 16 (Concedida S/D)	PETROPACK S.A.	144
525954	26/09/2022	PATRIMONIO CAFÉ (mixta)	43 (Concedida S/D) y 30 (Concedida S/D)	BAFANA S.R.L.	
525959	21/09/2022	B BROLI (mixta)	35 (Concedida S/D)	COPELMAYER DEMARIA PEDRO TOMAS Y FERNANDEZ TURREIRO VICTOR HUGO SOCIEDAD DE HECHO	
525963	21/09/2022	APARCERIA "LA BOLEADA" PAYSANDU (mixta)	41 (Concedida S/D)	HUGO PABLO NUÑEZ PEREZ	
525977	21/09/2022	RIVIERA PROFESSIONAL (mixta)	3 (Concedida)	Francisco Villalba	
525978	21/09/2022	LOVEGE	30 (Concedida) y 29 (Concedida)	MINBROL S.A.	189
525980	21/09/2022	PURETEC	11 (Concedida)	Diego Martínez	
525988	21/09/2022	LIKEWIZE	42 (Concedida S/D), 36 (Concedida S/D), 35 (Concedida S/D) y 9 (Concedida S/D)	Brightstar Corp.	216
525990	21/09/2022	KIU TOWERS	37 (Concedida), 36 (Concedida) y 19 (Concedida)	Martín Ignacio González Sanchez	94
525992	21/09/2022	KIU TOWER SOHO	37 (Concedida) y 19 (Concedida)	Martín Ignacio González Sanchez	94
525995	26/09/2022	CB COLDWELL BANKER	36 (Concedida S/D)	Coldwell Banker LLC	136

N° Exp	Resolución	Marca	Clases	Titular	Ag.
		COMMERCIAL (mixta)	y 35 (Concedida S/D)		
525996	26/09/2022	CB COLDWELL BANKER COMMERCIAL (mixta)	36 (Concedida S/D) y 35 (Concedida S/D)	Coldwell Banker LLC	136
525998	26/09/2022	THE GLOW FACTOR (mixta)	3 (Concedida S/D)	SIELECKI, VALENTINA	34
526000	19/09/2022	GOTA LIMPA (mixta)	21 (Concedida S/D)	JMC ADMINISTRAÇÃO E PARTICIPAÇÕES LTDA	212
526001	19/09/2022	DBCC TRANSPORT (mixta)	39 (Concedida S/D)	Liropa S.A	34
526003	30/09/2022	PROTEX ACTIVE SPORTS	3 (Concedida S/D)	COLGATE-PALMOLIVE COMPANY	201
526005	19/09/2022	CONTIVUE	10 (Concedida S/D)	F. HOFFMANN-LA ROCHE AG	201
526007	19/09/2022	NYR (mixta)	35 (Concedida)	NYR S.A.	201
526010	30/09/2022	ICG (mixta)	36 (Concedida) y 35 (Concedida)	ICG COMPANY S.A.	245
526013	30/09/2022	GO INTER (mixta)	35 (Concedida S/D) y 9 (Concedida S/D)	Banco Inter S.A.	144
526014	30/09/2022	INTER INTR BANK (mixta)	36 (Concedida S/D)	Banco Inter S.A.	144
526015	30/09/2022	INTER INTR CEL (mixta)	38 (Concedida S/D)	Banco Inter S.A.	144
526016	30/09/2022	INTER INTR SHOP (mixta)	45 (Concedida S/D) y 35 (Concedida S/D)	Banco Inter S.A.	144
526017	30/09/2022	INTER INTR SEGUROS (mixta)	36 (Concedida S/D)	Banco Inter S.A.	144
526018	30/09/2022	INTER INTR INVEST (mixta)	36 (Concedida S/D) y 35 (Concedida S/D)	Banco Inter S.A.	144
526019	30/09/2022	INTER INTR PLATFORM (mixta)	35 (Concedida S/D) y 9 (Concedida S/D)	Banco Inter S.A.	144
526020	30/09/2022	INTER INTR HOLDING (mixta)	45 (Concedida S/D) y 35 (Concedida S/D)	Banco Inter S.A.	144
526021	30/09/2022	INTER INTR FINANCE (mixta)	36 (Concedida S/D)	Banco Inter S.A.	144

N° Exp	Resolución	Marca	Clases	Titular	Ag.
			y 35 (Concedida S/D)		
526100	20/09/2022	LOS PIKANTES (mixta)	41 (Concedida)	Marcelo Sebastián Dos Santos Figueredo	220
526102	20/09/2022	FIJI (mixta)	32 (Concedida S/D)	Fiji Water Company Pte. Ltd.	216
526103	20/09/2022	(figurativa)	32 (Concedida S/D)	Fiji Water Company Pte. Ltd.	216
526106	20/09/2022	(figurativa)	42 (Concedida) y 9 (Concedida)	APPLE INC.	245
526108	20/09/2022	BASALOG ONE	5 (Concedida)	LABORATORIO LIBRA SOCIEDAD ANONIMA	129
526109	20/09/2022	TORRE QUÓRUM (mixta)	19 (Concedida)	CANIPEL S.A.	201
526113	20/09/2022	APATHEIA (mixta)	35 (Concedida) y 20 (Concedida)	DAVEL, JOSEFINA y CARNEIRO, ROSARIO	189
526114	20/09/2022	PATCH BAGS (mixta)	35 (Concedida)	Lucía Poñachik Rubiolo	212
526115	20/09/2022	VITOLEONE	9 (Concedida)	Mathias Goyhenetche	212
526116	26/09/2022	VITOLEONE	18 (Concedida)	Mathias Goyhenetche	212
526117	20/09/2022	VITOLEONE	35 (Concedida)	Mathias Goyhenetche	212
526119	26/09/2022	HILO ROSA (mixta)	35 (Concedida S/D)	CLAUDIA VALERIA FERME LARROSA	
526120	20/09/2022	XIPTIBA	5 (Concedida S/D)	NOVARTIS AG.	201
526121	20/09/2022	ZACTILBI	5 (Concedida S/D)	NOVARTIS AG.	201
526122	26/09/2022	NG NIQUEL&GOLD (mixta)	9 (Concedida)	Ivan Vegovich	
526123	20/09/2022	Z (mixta)	30 (Concedida S/D) y 29 (Concedida S/D)	STARZEN CO. LTD.	34
526124	20/09/2022	STARZEN (mixta)	30 (Concedida S/D) y 29 (Concedida S/D)	STARZEN CO. LTD.	34
526127	20/09/2022	(figurativa)	30 (Concedida S/D) y 29 (Concedida S/D)	STARZEN CO. LTD.	34
526134	26/09/2022	DOLCE & GABBANA P (mixta)	3 (Concedida S/D)	DOLCE & GABBANA TRADEMARKS S.R.L.	144
526137	20/09/2022	BLACK SUN (mixta)	9 (Concedida)	Ivan Vegovich	

N° Exp	Resolución	Marca	Clases	Titular	Ag.
526138	26/09/2022	MURGA MUNDIAL	41 (Concedida)	Raul Felipe Castro	172
526141	21/09/2022	WERFEN (mixta)	35 (Concedida S/D), 10 (Concedida S/D), 9 (Concedida S/D) y 5 (Concedida S/D)	WERFENLIFE S.A.	34
526142	26/09/2022	CUERVO EST.1960 PIZZA NAPOLETANA. (mixta)	43 (Concedida)	Rodrigo Flores Valli	
526144	26/09/2022	VIP HARMONY (mixta)	44 (Concedida) y 35 (Concedida)	Alejandra Beatriz Delgado Peralta	212
526152	26/09/2022	NEPTUNO PODCAST (mixta)	38 (Concedida S/D) y 35 (Concedida S/D)	Juan Elhordoy	
526160	21/09/2022	LIVPROTECT	5 (Concedida S/D)	A. Nattermann & Cie. GmbH	201
526161	26/09/2022	ESSENLIV	5 (Concedida S/D)	A. Nattermann & Cie. GmbH	201
526163	21/09/2022	MANTRA	20 (Concedida)	NYR S.A.	201
526174	26/09/2022	MUNDO DE CABALLOS (mixta)	41 (Concedida)	GABRIELA CECILIA FACCIO SANTIAGO	144
526176	29/09/2022	LISA BURGERS & DRINKS	43 (Concedida)	ABUTOR S.A.	118
526179	20/09/2022	BAIQIYA	9 (Concedida)	ROLACOR S. A.	220
526183	21/09/2022	EFFECTUS (mixta)	42 (Concedida) y 35 (Concedida)	EFFECTUS URUGUAY LTDA	216
526184	21/09/2022	EFFECTUS SOFTWARE (mixta)	42 (Concedida) y 35 (Concedida)	EFFECTUS URUGUAY LTDA	216
526185	21/09/2022	(figurativa)	42 (Concedida) y 35 (Concedida)	EFFECTUS URUGUAY LTDA	216
526186	27/09/2022	NESTLE CHOCOLATERIA (mixta)	30 (Concedida S/D)	Société des Produits Nestlé S.A.	156
526187	29/09/2022	FOX BUSINESS INTERNATIONAL (mixta)	41 (Concedida S/D), 38 (Concedida S/D) y 9 (Concedida S/D)	Fox Media LLC	245
526191	20/09/2022	BAMBÚ	30 (Concedida)	OSVERNA SOCIEDAD ANÓNIMA	189
526192	27/09/2022	ARBUSTA (mixta)	42 (Concedida) y 9 (Concedida)	SUMILAR S.A.	

N° Exp	Resolución	Marca	Clases	Titular	Ag.
526198	29/09/2022	SUDEL ENERGÍA PARA SUS IDEAS (mixta)	35 (Concedida), 19 (Concedida), 17 (Concedida), 11 (Concedida) y 9 (Concedida)	SUDEL S.A.	192
526199	27/09/2022	RCD RECICLAJE (mixta)	19 (Concedida)	RCD RECICLAJE SAS	212
526201	21/09/2022	RCD RECICLAJE (mixta)	35 (Concedida)	RCD RECICLAJE SAS	212
526204	21/09/2022	CONTRALAC	5 (Concedida S/D)	VIRBAC S.A.	201
526206	21/09/2022	EMZELBI	5 (Concedida S/D)	NOVARTIS AG.	201
526209	21/09/2022	OPTI-DP	42 (Concedida S/D) y 9 (Concedida S/D)	Wärtsilä Technology Oy Ab	179
526215	21/09/2022	DOCK	25 (Concedida S/D)	"Dr. Martens" International Trading GmbH y "Dr. Maertens" Marketing GmbH	136
526216	21/09/2022	RCD RECICLAJE (mixta)	42 (Concedida)	RCD RECICLAJE SAS	212
526222	26/09/2022	SPEVIGO	5 (Concedida S/D)	Boehringer Ingelheim International GmbH	136
526225	26/09/2022	FETISH	3 (Concedida S/D)	Antonio Puig, S.A.	144
526226	26/09/2022	DURILON	5 (Concedida S/D)	BASF SE	144
526227	26/09/2022	EFFICON	5 (Concedida S/D)	BASF SE	144
526246	26/09/2022	EXLABESA (mixta)	40 (Concedida S/D) y 6 (Concedida S/D)	Exlabesa Building Systems Limited	216
526247	30/09/2022	TOC BIOMETRICS	42 (Concedida S/D), 38 (Concedida S/D) y 9 (Concedida S/D)	TOC S.A.	205
526249	26/09/2022	COPACOL	29 (Concedida S/D)	COPACOL - COOPERATIVA AGROINDUSTRIAL CONSOLATA	34
526254	26/09/2022	POMANDER YOGA (mixta)	3 (Concedida S/D)	MONARI, RISSATO & ALVES IMPORTAÇÃO E EXPORTAÇÃO DE ESSÊNCIAS LTDA	34
526259	26/09/2022	GUEVV (mixta)	44 (Concedida)	Caussade, Graciela Ariadna; Rivero Gadea, Sandra; Fernández Damboriarena, María Ximena; Perez María Noel; Infante Castro, Alfonsina; Rodríguez María Carmen; Bertolino Luciana;	245

N° Exp	Resolución	Marca	Clases	Titular	Ag.
				Perez Perez Natalia María; Long María Fernanda y Beracochea Centurión, Andrea Verónica	
526261	26/09/2022	ALKILATE (mixta)	35 (Concedida)	SANTIAGO DABALA	
526262	26/09/2022	E ECOLOGIC TECH (mixta)	39 (Concedida) y 35 (Concedida)	Kelten S.A	
526264	26/09/2022	GOOD BRANDS (mixta)	5 (Concedida) y 3 (Concedida)	GOOD BRANDS EIRL	144
526265	26/09/2022	BIOCLEAN DERMIS (mixta)	5 (Concedida S/D)	GOOD BRANDS EIRL	144
526266	26/09/2022	GLORANTA (mixta)	5 (Concedida)	GOOD BRANDS EIRL	144
526267	26/09/2022	CNP (mixta)	36 (Concedida S/D)	CNP ASSURANCES	129
526268	30/09/2022	BODY PEELING DERMUR (mixta)	3 (Concedida)	LABORATORIOS CELSIUS S.A.	144
526269	30/09/2022	CLAUSEN	5 (Concedida)	LABORATORIOS CLAUSEN S.A.	144
526270	30/09/2022	LICEBRAL CELSIUS	5 (Concedida)	LABORATORIOS CELSIUS S.A.	144
526271	30/09/2022	NEURALZEM	5 (Concedida)	LABORATORIOS CELSIUS S.A.	144
526272	30/09/2022	NIDIONA FISCHER	5 (Concedida)	LABORATORIOS CELSIUS S.A.	144
526273	30/09/2022	NULACID CELSIUS	5 (Concedida)	LABORATORIOS CELSIUS S.A.	144
526274	30/09/2022	OSTEOVIVA	5 (Concedida)	Megalabs Uruguay S.A.	144
526275	30/09/2022	RALIXON CELSIUS	5 (Concedida)	LABORATORIOS CELSIUS S.A.	144
526279	30/09/2022	GLUTACTIVE (mixta)	5 (Concedida S/D)	UPHARVEN, C.A.	144
526281	30/09/2022	KAISEN	36 (Concedida)	Gustavo Conrado Consonni Morales	94
526282	30/09/2022	ENERSYS	11 (Concedida)	Arturo José Correa Falcone	222
526283	30/09/2022	AQUAGENIUS SMARTER USE OF WATER (mixta)	11 (Concedida)	PRESNO SANDAR SEBASTIAN, BUYSAN RAMAYON JUAN PEDRO Y OTROS SOCIEDAD DE HECHO	
526284	30/09/2022	MEETION (mixta)	20 (Concedida S/D)	SHENZHEN MEETION TECH CO., LTD	201
526285	30/09/2022	(figurativa)	5 (Concedida S/D)	NOVARTIS AG.	201
526289	30/09/2022	ENDOSCOPYNET GASTROENTEROLOGIA & ENDOSCOPIA (mixta)	44 (Concedida)	INSTITUTO ECUATORIANO DE ENFERMEDADES DIGESTIVAS GASTROCLÍNICA S.A.	201
526291	30/09/2022	A ATKORE (mixta)	42 (Concedida S/D),	Allied Tube & Conduit Corporation	245

N° Exp	Resolución	Marca	Clases	Titular	Ag.
			40 (Concedida S/D), 37 (Concedida S/D), 19 (Concedida S/D), 11 (Concedida S/D), 9 (Concedida S/D), 6 (Concedida S/D) y 2 (Concedida S/D)		
526295	30/09/2022	TOYOBO (mixta)	1 (Concedida S/D)	Toyobo Co., Ltd.	136
526298	30/09/2022	TVERDE	36 (Concedida)	FUCAC VERDE COOPERATIVA DE AHORRO Y CREDITO	201
526299	30/09/2022	DEVERDE	36 (Concedida)	FUCAC VERDE COOPERATIVA DE AHORRO Y CREDITO	201
526300	21/09/2022	DVERDE	36 (Concedida)	FUCAC VERDE COOPERATIVA DE AHORRO Y CREDITO	201
526305	21/09/2022	COTTOLENGO DON ORIONE	45 (Concedida), 44 (Concedida), 43 (Concedida), 41 (Concedida), 38 (Concedida), 36 (Concedida) y 35 (Concedida)	Asociación Pequeñas Hermanas Misioneras de la Caridad (Don Orione) y ASOCIACION "PEQUEÑA OBRA DE LA DIVINA PROVIDENCIA"	194
526309	27/09/2022	IDAI NATURE A ROVENSA COMPANY (mixta)	5 (Concedida S/D) y 1 (Concedida S/D)	IDAI NATURE S.L.	34
526310	21/09/2022	DON ORIONE	45 (Concedida), 44 (Concedida), 43 (Concedida), 41 (Concedida), 38 (Concedida), 36 (Concedida) y 35 (Concedida)	Asociación Pequeñas Hermanas Misioneras de la Caridad (Don Orione) y ASOCIACION "PEQUEÑA OBRA DE LA DIVINA PROVIDENCIA"	194
526311	21/09/2022	CENTRO EDUCATIVO DON ORIONE	41 (Concedida)	Asociación Pequeñas Hermanas Misioneras de la	194

N° Exp	Resolución	Marca	Clases	Titular	Ag.
				Caridad (Don Orione) y ASOCIACION "PEQUEÑA OBRA DE LA DIVINA PROVIDENCIA"	
526313	30/09/2022	FM COTTOLENGO	38 (Concedida)	Asociación Pequeñas Hermanas Misioneras de la Caridad (Don Orione) y ASOCIACION "PEQUEÑA OBRA DE LA DIVINA PROVIDENCIA"	194
526314	21/09/2022	A ATKORE (mixta)	42 (Concedida S/D), 40 (Concedida S/D), 37 (Concedida S/D), 19 (Concedida S/D), 11 (Concedida S/D), 9 (Concedida S/D), 6 (Concedida S/D) y 2 (Concedida S/D)	Allied Tube & Conduit Corporation	245
526315	21/09/2022	ATKORE	42 (Concedida S/D), 40 (Concedida S/D), 37 (Concedida S/D), 19 (Concedida S/D), 11 (Concedida S/D), 9 (Concedida S/D), 6 (Concedida S/D) y 2 (Concedida S/D)	Allied Tube & Conduit Corporation	245
526316	21/09/2022	LAS PRADERAS (mixta)	37 (Concedida S/D) y 36 (Concedida S/D)	Agroindustrias Uruguay Sociedad Anónima	
526317	21/09/2022	POWERBLEND	30 (Concedida S/D), 29 (Concedida S/D) y 5 (Concedida S/D)	Société des Produits Nestlé S.A.	156
526318	21/09/2022	NAPUL È BY L.I. (mixta)	43 (Concedida S/D) y 30 (Concedida S/D)	Victor Roque Moya	

N° Exp	Resolución	Marca	Clases	Titular	Ag.
			S/D)		
526319	21/09/2022	REVOLUTION	10 (Concedida S/D)	Alcon Inc.	194
526321	21/09/2022	TAKESHI SUSHI (mixta)	43 (Concedida)	TAKESHI S.A.S.	189
526322	26/09/2022	NIPPY (mixta)	35 (Concedida) y 9 (Concedida)	AMONDARAY, DIEGO OSCAR	201
526332	26/09/2022	PEREIRA AMARO INMOBILIARIA (mixta)	36 (Concedida S/D)	Paola Annabella Pereira Amaro	
526333	26/09/2022	VITABIOTICS	5 (Concedida S/D)	Vitabiotics Ltd	136
526334	26/09/2022	FIFA FOUNDATION (mixta)	41 (Concedida S/D), 36 (Concedida S/D), 35 (Concedida S/D), 28 (Concedida S/D), 25 (Concedida S/D) y 16 (Concedida S/D)	Fédération Internationale de Football Association (FIFA)	136
526336	26/09/2022	SAINT JAMES (mixta)	25 (Concedida)	S.A.S. TRICOTS SAINT JAMES	181
526337	21/09/2022	DECABOT (mixta)	9 (Concedida S/D) y 7 (Concedida S/D)	Suzhou Dake Investment Consultation Co., Ltd.	144
526347	21/09/2022	EVENTIFICA (mixta)	42 (Concedida)	Federico Kalayjian y Alex Kalayjian	
526349	26/09/2022	CHIARINO UNIFORMES EST 1991 (mixta)	25 (Concedida)	MCCH UNIFORMES SRL	232
526352	26/09/2022	PACKDEPORTES (mixta)	35 (Concedida), 28 (Concedida) y 25 (Concedida)	CASTRO BARCELONA MAXIMILIANO SEBASTIAN	194
526353	30/09/2022	ZALUTEX ELEA (mixta)	5 (Concedida)	LABORATORIO ELEA PHOENIX S.A.	34
526355	21/09/2022	SOLOIST	12 (Concedida S/D)	Cervélo USA, Inc.	34
526357	21/09/2022	TRIGGLE	35 (Concedida S/D)	TRIGGLE AG	34
526358	21/09/2022	TRIGGLE (mixta)	35 (Concedida S/D)	TRIGGLE AG	34
526359	21/09/2022	D.A.S. (mixta)	9 (Concedida S/D)	DAS AUDIO GROUP, S.L.	201
526361	29/09/2022	LUNDBECK (mixta)	5 (Concedida S/D)	H. Lundbeck A/S	156
526367	26/09/2022	LA PRAIRIE SWITZERLAND (mixta)	44 (Concedida S/D),	LABORATOIRES LA PRAIRIE SA	136

N° Exp	Resolución	Marca	Clases	Titular	Ag.
			21 (Concedida S/D) y 3 (Concedida S/D)		
526369	26/09/2022	LA PRAIRIE SWITZERLAND (mixta)	44 (Concedida S/D), 21 (Concedida S/D) y 3 (Concedida S/D)	LABORATOIRES LA PRAIRIE SA	136
526376	26/09/2022	TENTACIONES MVD (mixta)	43 (Concedida)	DA SILVA RAMIA, ANDRÉS	189
526377	21/09/2022	NUDO	25 (Concedida)	Mariana de Brum	
526385	29/09/2022	MICHELOB ULTRA PURE GOLD (mixta)	32 (Concedida S/D)	Anheuser-Busch, LLC	144
526391	27/09/2022	HYDOR (mixta)	5 (Concedida) y 1 (Concedida)	Freeport Trading SAS	172
526392	26/09/2022	VERDE (mixta)	36 (Concedida)	FUCAC VERDE COOPERATIVA DE AHORRO Y CREDITO	201
526394	26/09/2022	VERDE (mixta)	36 (Concedida)	FUCAC VERDE COOPERATIVA DE AHORRO Y CREDITO	201
526395	26/09/2022	CRUN (mixta)	7 (Concedida S/D)	Sichuan CRUN Co., Ltd.	34
526399	27/09/2022	EXTREME (mixta)	21 (Concedida), 16 (Concedida), 14 (Concedida), 11 (Concedida), 5 (Concedida) y 3 (Concedida)	TA -TA S.A.	245
526401	21/09/2022	MTG	18 (Concedida S/D) y 9 (Concedida S/D)	Targus International LLC	245
526403	29/09/2022	E YUMBO NEXT (mixta)	12 (Concedida)	DECELESTE S.A.	189
526406	21/09/2022	26 1 18 1 (mixta)	28 (Concedida), 27 (Concedida), 26 (Concedida), 25 (Concedida), 24 (Concedida), 21 (Concedida), 18	INDUSTRIA DE DISEÑO TEXTIL, S.A. (INDITEX, S.A.)	201

N° Exp	Resolución	Marca	Clases	Titular	Ag.
			(Concedida) y 9 (Concedida)		
526407	29/09/2022	SALY PINK (mixta)	35 (Concedida) y 3 (Concedida)	GUILLERMO LOBATO y MARTIN LOBATO	219
526416	21/09/2022	JUNTOS+ (mixta)	42 (Concedida S/D), 38 (Concedida S/D), 35 (Concedida S/D) y 9 (Concedida S/D)	Coca-Cola Femsa S.A.B. de C.V.	216
526418	26/09/2022	MARY KAY CONFIDENCE 360	3 (Concedida S/D)	MARY KAY INC.	144
526419	26/09/2022	MARY KAY CONFIDENCE 360	35 (Concedida S/D)	MARY KAY INC.	144
526420	26/09/2022	MARY KAY CONFIDENCE 360	41 (Concedida S/D)	MARY KAY INC.	144
526421	26/09/2022	JUNTOS+ (mixta)	42 (Concedida S/D), 38 (Concedida S/D), 35 (Concedida S/D) y 9 (Concedida S/D)	Coca-Cola Femsa S.A.B. de C.V.	216
526422	27/09/2022	JUNTOS+.COM (mixta)	42 (Concedida S/D), 38 (Concedida S/D), 35 (Concedida S/D) y 9 (Concedida S/D)	Coca-Cola Femsa S.A.B. de C.V.	216
526423	27/09/2022	JUNTOSPLUS (mixta)	42 (Concedida S/D), 38 (Concedida S/D), 35 (Concedida S/D) y 9 (Concedida S/D)	Coca-Cola Femsa S.A.B. de C.V.	216
526424	27/09/2022	JUNTOSPLUS.COM (mixta)	42 (Concedida S/D), 38 (Concedida S/D), 35 (Concedida S/D) y 9 (Concedida S/D)	Coca-Cola Femsa S.A.B. de C.V.	216
526433	29/09/2022	SURCOS	44 (Concedida), 5 (Concedida) y 1 (Concedida)	Mundo Surcos S.A.	220
526440	26/09/2022	LIVE RUN (mixta)	25 (Concedida)	CASTRO FERNANDEZ ENZO WILMAR	

N° Exp	Resolución	Marca	Clases	Titular	Ag.
526441	27/09/2022	AIR ZOOM	25 (Concedida S/D)	NIKE INNOVATE C.V. una sociedad holandesa limitada (commanditaire vennootschap) organizada y existente bajo las leyes de Holanda	192
526442	26/09/2022	(figurativa)	25 (Concedida S/D), 24 (Concedida S/D), 21 (Concedida S/D), 18 (Concedida S/D) y 9 (Concedida S/D)	Klippan Yllefabrik AB	179
526444	26/09/2022	KLIPPAN	25 (Concedida S/D), 24 (Concedida S/D), 21 (Concedida S/D), 18 (Concedida S/D) y 9 (Concedida S/D)	Klippan Yllefabrik AB	179
526446	29/09/2022	COMO EVA. (mixta)	35 (Concedida S/D) y 25 (Concedida)	CASTRO AREOSA MARCELO FERNANDO	
526448	29/09/2022	NIVEA TONO NATURAL	3 (Concedida S/D)	Beiersdorf AG	136
526450	26/09/2022	HIFRENZO	5 (Concedida S/D)	AstraZeneca AB	136
526451	21/09/2022	PRULIX	5 (Concedida)	BALIARDA S.A.	201
526452	29/09/2022	LABORATORIOS FELIPE BAJER	5 (Concedida) y 3 (Concedida)	LABORATORIOS FELIPE BAJER S.A.I.C.	201
526455	21/09/2022	HINENI	37 (Concedida), 36 (Concedida), 35 (Concedida), 25 (Concedida) y 12 (Concedida)	LEMPERT SOFFER, GRACIELA	201
526459	21/09/2022	WGN	39 (Concedida S/D) y 5 (Concedida S/D)	WORLD GREEN NUTRITION, INC.	94
526460	21/09/2022	WGN INC. (mixta)	39 (Concedida S/D) y 5 (Concedida S/D)	WORLD GREEN NUTRITION, INC.	94
526466	27/09/2022	G GAUDIN (mixta)	35 (Concedida) y 11 (Concedida)	NATALIA LARROSA	163

N° Exp	Resolución	Marca	Clases	Titular	Ag.
526467	27/09/2022	VROOM (mixta)	45 (Concedida S/D), 42 (Concedida S/D), 41 (Concedida S/D), 35 (Concedida S/D), 16 (Concedida S/D) y 9 (Concedida S/D)	Bezos Family Foundation	136
526469	29/09/2022	VROOM (mixta)	5 (Concedida S/D)	Bezos Family Foundation	136
526470	29/09/2022	ISABEL CALIDAD DESDE 1887 (mixta)	35 (Concedida S/D), 30 (Concedida S/D) y 29 (Concedida S/D)	GRUPO CONSERVAS GARAVILLA, S.L.	34
526471	29/09/2022	ISABEL CALIDAD DESDE 1887 (mixta)	35 (Concedida S/D), 30 (Concedida S/D) y 29 (Concedida S/D)	GRUPO CONSERVAS GARAVILLA, S.L.	34
526475	29/09/2022	AVON SOFT MUSK DELICE	3 (Concedida S/D)	AVON PRODUCTS, INC.	194
526476	29/09/2022	RSQ3	12 (Concedida S/D)	AUDI AG	219
526477	30/09/2022	NPK ENGINE PARTS (mixta)	12 (Concedida)	Sergio Antonio Gallardo	212
526480	30/09/2022	PICKERS BY PICKIT (mixta)	43 (Concedida S/D), 39 (Concedida S/D) y 9 (Concedida S/D)	Pickit LLC	201
526482	30/09/2022	NUTRICIÓN MOLECULAR (mixta)	5 (Concedida)	LAKS, GABRIELA	201
526484	30/09/2022	MERZ AESTHETICS	42 (Concedida S/D), 41 (Concedida S/D), 35 (Concedida S/D), 16 (Concedida S/D), 10 (Concedida S/D) y 5 (Concedida S/D)	Merz Pharma GmbH & Co. KGaA	179
526486	29/09/2022	DOC MARTEN	25 (Concedida S/D) y 18 (Concedida S/D)	"Dr. Martens" International Trading GmbH y "Dr. Maertens" Marketing GmbH	136

N° Exp	Resolución	Marca	Clases	Titular	Ag.
526496	27/09/2022	SPARKLING (mixta)	35 (Concedida)	MIBASA S.A. de C.V	94
526501	26/09/2022	ALOT (mixta)	35 (Concedida), 20 (Concedida), 16 (Concedida), 9 (Concedida) y 2 (Concedida)	OFFICENET S.A.	201
526504	26/09/2022	EQUITONE	19 (Concedida S/D)	ETEX NV	201
526506	26/09/2022	YO TE ABRIGO	25 (Concedida)	Empcatex S.R.L	154
526509	26/09/2022	DANADS	42 (Concedida S/D), 35 (Concedida S/D) y 9 (Concedida S/D)	DanAds International AB	201
526510	26/09/2022	TROLLI (mixta)	30 (Concedida S/D)	Mederer GmbH	165
526512	27/09/2022	GARRAVAC	5 (Concedida)	KÖNIG URUGUAY SOCIEDAD ANONIMA	129
526513	26/09/2022	(figurativa)	45 (Concedida S/D), 42 (Concedida S/D), 41 (Concedida S/D), 40 (Concedida S/D), 39 (Concedida S/D), 37 (Concedida S/D), 36 (Concedida S/D), 35 (Concedida S/D), 11 (Concedida S/D) y 7 (Concedida S/D)	Rivian IP Holdings, LLC	216
526514	26/09/2022	RIVIAN	45 (Concedida S/D), 42 (Concedida S/D), 41 (Concedida S/D), 40 (Concedida S/D), 39 (Concedida S/D), 37 (Concedida S/D), 36 (Concedida S/D), 35 (Concedida S/D),	Rivian IP Holdings, LLC	216

N° Exp	Resolución	Marca	Clases	Titular	Ag.
			11 (Concedida S/D) y 7 (Concedida S/D)		
526519	26/09/2022	ALTA GRACIA (mixta)	42 (Concedida), 20 (Concedida) y 11 (Concedida)	LUZ MARINA CARBALLIDO	105
526526	30/09/2022	ELECTRO URUGUAY ILUMINAMOS TU ENERGÍA (mixta)	35 (Concedida)	Nordica S.A.	181
526528	26/09/2022	PETLOVE	35 (Concedida)	Sucan Uruguay SRL	144
526530	26/09/2022	SUCAN (mixta)	35 (Concedida)	Sucan Uruguay SRL	144
526533	29/09/2022	OBITUARIOS DE HOY (mixta)	45 (Concedida) y 41 (Concedida)	TERESITA MARIA CAMEJO MENDOZA	105
526534	27/09/2022	TERRAZAS	29 (Concedida)	BALESTRINI ROBINSON SEBASTIAN, BALESTRINI ROBINSON SANTIAGO Y OTROS	201
526535	30/09/2022	IDEAL IMPULSORA DEL DESARROLLO Y EL EMPLEO EN AMERICA LATINA (mixta)	42 (Concedida), 41 (Concedida), 40 (Concedida), 39 (Concedida), 37 (Concedida), 36 (Concedida) y 6 (Concedida)	IMPULSORA DEL DESARROLLO Y EL EMPLEO EN AMÉRICA LATINA, S.A.B. DE C.V.	235
526537	26/09/2022	BMATH (mixta)	41 (Concedida S/D) y 9 (Concedida S/D)	INNOVAMAT EDUCATION, S.L.	144
526538	29/09/2022	DRACO ORBIS TERRARUM MANUS MEA (mixta)	36 (Concedida)	DRACO CAPITAL INVESTMENT MANAGEMENT COMPANY S.A.	34
526542	29/09/2022	G&H (mixta)	3 (Concedida S/D)	ALTICOR INC	34
526543	26/09/2022	ELEFIX ELEA	5 (Concedida)	LABORATORIO ELEA PHOENIX S.A.	34
526545	29/09/2022	REDDER RED DE REFERENTES	45 (Concedida)	Asociación Civil sin fines de lucro Red de Referentes	212
526548	29/09/2022	BEBUY BABY STORE (mixta)	35 (Concedida)	EVERPIX S.A.S.	192
526549	26/09/2022	SIDECAR	9 (Concedida S/D)	APPLE INC.	245

N° Exp	Resolución	Marca	Clases	Titular	Ag.
526553	27/09/2022	OMNIA BOTANICA (mixta)	3 (Concedida)	TABARE PALERMO	
526559	29/09/2022	HERMETITE (mixta)	17 (Concedida)	IJASA	201
526569	27/09/2022	AMJOURNA	5 (Concedida S/D)	SANOFI	144
526570	27/09/2022	AMTRUMEERA	5 (Concedida S/D)	SANOFI	144
526571	27/09/2022	AMYFORZA	5 (Concedida S/D)	SANOFI	144
526572	27/09/2022	AMZEZMA	5 (Concedida S/D)	SANOFI	144
526573	27/09/2022	AMZEVNA	5 (Concedida S/D)	SANOFI	144
526574	27/09/2022	KORJAYA	5 (Concedida S/D)	SANOFI	144
526577	27/09/2022	TRIUNFO	5 (Concedida)	Proquimur S.A.	172
526579	29/09/2022	GOL	9 (Concedida)	Oscar Fabian Ramirez	172
526583	29/09/2022	GALAXIS FRONTIER	5 (Concedida S/D)	NATIVE MICROBIALS Inc.	34
526587	30/09/2022	FARO WEALTH MANAGEMENT (mixta)	36 (Concedida)	Frukeb S.A.	212
526588	29/09/2022	NOVAMUNE (mixta)	5 (Concedida S/D)	CEVA SANTE ANIMALE	34
526589	29/09/2022	ELAR-B	5 (Concedida S/D)	SOPHIA HOLDINGS, S.A. DE C.V.	34
526590	29/09/2022	EXEGER	42 (Concedida S/D), 40 (Concedida S/D), 37 (Concedida S/D), 28 (Concedida S/D), 25 (Concedida S/D), 20 (Concedida S/D), 19 (Concedida S/D), 18 (Concedida S/D), 14 (Concedida S/D), 12 (Concedida S/D), 11 (Concedida S/D), 9 (Concedida S/D), 7 (Concedida S/D) y 6 (Concedida S/D)	Exeger Operations AB	218
526592	29/09/2022	POWERFOYLE	42 (Concedida S/D), 40 (Concedida S/D),	Exeger Operations AB	218

N° Exp	Resolución	Marca	Clases	Titular	Ag.
			37 (Concedida S/D), 28 (Concedida S/D), 25 (Concedida S/D), 20 (Concedida S/D), 19 (Concedida S/D), 18 (Concedida S/D), 14 (Concedida S/D), 12 (Concedida S/D), 11 (Concedida S/D), 9 (Concedida S/D), 7 (Concedida S/D) y 6 (Concedida S/D)		
526594	29/09/2022	PROTEIN GOD	30 (Concedida S/D)	Facundo Arellano y Mauricio Casella	
526596	29/09/2022	POWERFOYLE (mixta)	42 (Concedida S/D), 40 (Concedida S/D), 37 (Concedida S/D), 28 (Concedida S/D), 25 (Concedida S/D), 20 (Concedida S/D), 19 (Concedida S/D), 18 (Concedida S/D), 14 (Concedida S/D), 12 (Concedida S/D), 11 (Concedida S/D), 9 (Concedida S/D), 7 (Concedida S/D) y 6 (Concedida S/D)	Exeger Operations AB	218
526597	27/09/2022	EXEGER (mixta)	42 (Concedida S/D), 40 (Concedida S/D), 37 (Concedida S/D), 28 (Concedida S/D),	Exeger Operations AB	218

N° Exp	Resolución	Marca	Clases	Titular	Ag.
			25 (Concedida S/D), 20 (Concedida S/D), 19 (Concedida S/D), 18 (Concedida S/D), 14 (Concedida S/D), 12 (Concedida S/D), 11 (Concedida S/D), 9 (Concedida S/D), 7 (Concedida S/D) y 6 (Concedida S/D)		
526598	27/09/2022	X (mixta)	42 (Concedida S/D), 40 (Concedida S/D), 37 (Concedida S/D), 28 (Concedida S/D), 25 (Concedida S/D), 20 (Concedida S/D), 19 (Concedida S/D), 18 (Concedida S/D), 14 (Concedida S/D), 12 (Concedida S/D), 11 (Concedida S/D), 9 (Concedida S/D), 7 (Concedida S/D) y 6 (Concedida S/D)	Exeger Operations AB	218
526607	26/09/2022	BICARDIAL (mixta)	5 (Concedida S/D)	MEDIFARMA S.A.	181
526609	26/09/2022	MARTEN	25 (Concedida S/D)	"Dr. Martens" International Trading GmbH y "Dr. Maertens" Marketing GmbH	136
526611	26/09/2022	MARTENS	25 (Concedida S/D)	"Dr. Martens" International Trading GmbH y "Dr. Maertens" Marketing GmbH	136
526612	26/09/2022	SEALAND A MAERSK COMPANY (mixta)	39 (Concedida S/D), 38 (Concedida S/D),	A.P. MØLLER – MÆRSK A/S	192

N° Exp	Resolución	Marca	Clases	Titular	Ag.
			36 (Concedida S/D) y 35 (Concedida S/D)		
526613	30/09/2022	PRIME DAY	35 (Concedida S/D)	Amazon Technologies, Inc.	136
526615	26/09/2022	NIVEA BY LABELLO (mixta)	3 (Concedida S/D)	Beiersdorf AG	136
526616	30/09/2022	EL TREN DE LA COSTA (mixta)	41 (Concedida) y 39 (Concedida)	Trencito de la Costa Srl	
526621	30/09/2022	JARLSBERG (mixta)	29 (Concedida S/D)	TINE S.A.	194
526622	30/09/2022	JARLSBERG (mixta)	29 (Concedida S/D)	TINE S.A.	194
526623	30/09/2022	JARLSBERG (mixta)	29 (Concedida S/D)	TINE S.A.	194
526624	30/09/2022	C.N.DEF.TV (mixta)	41 (Concedida) y 38 (Concedida)	Club Nacional de Football	144
526625	30/09/2022	C.N.DEF.TV+ (mixta)	41 (Concedida) y 38 (Concedida)	Club Nacional de Football	144
526627	30/09/2022	BO (mixta)	45 (Concedida)	CASTILLO DIAZ AGUSTIN SANTIAGO Y VIGO ROCCA MARIA SOCIEDAD DE HECHO	220
526628	30/09/2022	MEN FARMACITY (mixta)	44 (Concedida), 41 (Concedida), 35 (Concedida), 26 (Concedida), 21 (Concedida), 16 (Concedida), 14 (Concedida), 10 (Concedida), 9 (Concedida), 8 (Concedida), 5 (Concedida) y 3 (Concedida)	FARMCITY S.A.	245
526629	30/09/2022	MEN FARMACITY	44 (Concedida), 41 (Concedida), 35	FARMCITY S.A.	245

N° Exp	Resolución	Marca	Clases	Titular	Ag.
			(Concedida), 26 (Concedida), 21 (Concedida), 16 (Concedida), 14 (Concedida), 10 (Concedida), 9 (Concedida), 8 (Concedida), 5 (Concedida) y 3 (Concedida)		
526634	30/09/2022	PUNTA DEL ESTE FREE ZONE (mixta)	41 (Concedida), 36 (Concedida) y 35 (Concedida)	AZNAREZ MORELLI, NICOLAS	201
526636	30/09/2022	AMANDA	25 (Concedida S/D)	RAUL MAURENTE	
526639	30/09/2022	SABORES DE ROCHA (mixta)	43 (Concedida S/D), 41 (Concedida S/D), 38 (Concedida S/D), 35 (Concedida S/D), 30 (Concedida S/D) y 29 (Concedida S/D)	Corporacion Rochense de Turismo y Dirección de Turismo de Rocha	
526640	30/09/2022	THICKENUP	5 (Concedida S/D)	Société des Produits Nestlé S.A.	156
526647	30/09/2022	ADES ES ALIMENTO DE SEMILLAS (mixta)	29 (Concedida)	THE COCA-COLA COMPANY	94
526648	30/09/2022	ADES ES ALIMENTO DE SEMILLAS (mixta)	32 (Concedida)	THE COCA-COLA COMPANY	94
526649	30/09/2022	VALONTANO (mixta)	43 (Concedida), 32 (Concedida) y 30 (Concedida)	BRUNO BELLINI	94
526650	30/09/2022	E (mixta)	40 (Concedida S/D) y 6 (Concedida S/D)	Exlabesa Building Systems Limited	216

N° Exp	Resolución	Marca	Clases	Titular	Ag.
526651	30/09/2022	KIRIALYS (mixta)	5 (Concedida S/D) y 3 (Concedida S/D)	PHARMAESTHETICS DO BRASIL - INDUSTRIA DE MEDICAMENTOS LTDA.	216
526652	30/09/2022	PHARMAESTHETICS (mixta)	35 (Concedida S/D)	PHARMAESTHETICS DO BRASIL - INDUSTRIA DE MEDICAMENTOS LTDA.	216
526653	30/09/2022	PEKA (mixta)	11 (Concedida S/D)	PEKA THERM, S.L.	144
526655	30/09/2022	PARIFEX (mixta)	9 (Concedida S/D)	PARIFEX	144
526656	30/09/2022	PARIFEX (mixta)	9 (Concedida S/D)	PARIFEX	144
526658	30/09/2022	PARIFEX	42 (Concedida S/D), 38 (Concedida S/D), 37 (Concedida S/D) y 9 (Concedida S/D)	PARIFEX	144
526660	30/09/2022	999.9	34 (Concedida S/D)	The Triad Firm Holdings Limited	194
526704	30/09/2022	TRAINING GUARD	3 (Concedida S/D)	The Gillette Company LLC	212
526705	30/09/2022	GILLETTE SPECIALIZED PRO	3 (Concedida S/D)	The Gillette Company LLC	212
526707	30/09/2022	ROMPELA	32 (Concedida)	PEPSICO, INC.	201
526708	30/09/2022	GILLETTE SPECIALIZED	3 (Concedida S/D)	The Gillette Company LLC	212
526711	30/09/2022	LOMVUM (mixta)	8 (Concedida) y 7 (Concedida)	FERNANDO PORCELLA	192
526800	29/09/2022	CENTER STAGE	9 (Concedida)	APPLE INC.	245
526803	29/09/2022	GOLAZO	9 (Concedida)	Oscar Fabian Ramirez	172
526805	29/09/2022	3N3 (mixta)	17 (Concedida S/D)	NICIEZA Y TAVERNA HERMANOS S.A.I.C.y A.	212
526809	29/09/2022	(figurativa)	39 (Concedida S/D) y 37 (Concedida S/D)	Jet Aviation International, Inc.	212
526815	30/09/2022	BIOACTIVE (mixta)	28 (Concedida S/D), 27 (Concedida S/D) y 25 (Concedida S/D)	AGUSTIN FOLLE	
526816	30/09/2022	SCOTIABANK (mixta)	45 (Concedida S/D), 42 (Concedida S/D),	THE BANK OF NOVA SCOTIA	94

N° Exp	Resolución	Marca	Clases	Titular	Ag.
			38 (Concedida S/D), 36 (Concedida S/D), 35 (Concedida S/D) y 9 (Concedida S/D)		
526820	29/09/2022	K KYRIOS (mixta)	25 (Concedida)	GONZALEZ DE BOGADO, ALBA ROSA	201
526823	30/09/2022	MARY KAY DAILY BENEFITS	29 (Concedida S/D)	MARY KAY INC.	144
526824	30/09/2022	MARY KAY DAILY BENEFITS	30 (Concedida S/D)	MARY KAY INC.	144
526826	29/09/2022	HOFF (mixta)	18 (Concedida S/D)	THE HOFF BRAND, S.L.	144
526844	30/09/2022	SPIKEVAX	5 (Concedida S/D)	ModernaTX, Inc. (a corporation of Delaware, U.S.A.)	34
526846	30/09/2022	(figurativa)	5 (Concedida S/D)	ModernaTX, Inc. (a corporation of Delaware, U.S.A.)	34
526848	30/09/2022	FARMACITY SKIN (mixta)	5 (Concedida) y 3 (Concedida)	FARMCITY S.A.	245
526850	30/09/2022	FARMACITY BEBÉ	16 (Concedida)	FARMCITY S.A.	245
526851	30/09/2022	FARMACITY BEBÉ (mixta)	16 (Concedida)	FARMCITY S.A.	245
526856	30/09/2022	M2 PILAY	37 (Concedida), 36 (Concedida) y 35 (Concedida)	Pilay Uruguay Administradora de Fondos de Inversión	154
526857	30/09/2022	M2 PILAY URUGUAY	37 (Concedida), 36 (Concedida) y 35 (Concedida)	Pilay Uruguay Administradora de Fondos de Inversión S.A.	154
526860	30/09/2022	L LADRILLOS (mixta)	37 (Concedida), 36 (Concedida) y 35 (Concedida)	Pilay Uruguay Administradora de Fondos de Inversión S.A.	154
526862	30/09/2022	FRIKE BIKE	25 (Concedida) y 9 (Concedida)	KERAN S.A.	189
526864	30/09/2022	R2	12 (Concedida S/D)	YAMAHA HATSUDOKI KABUSHIKI KAISHA	201
526865	30/09/2022	R7	12 (Concedida S/D)	YAMAHA HATSUDOKI KABUSHIKI KAISHA	201
526866	30/09/2022	R9	12 (Concedida S/D)	YAMAHA HATSUDOKI KABUSHIKI KAISHA	201
526869	30/09/2022	MERAKI	42 (Concedida S/D)	Cisco Technology, Inc.	136

N° Exp	Resolución	Marca	Clases	Titular	Ag.
			y 9 (Concedida S/D)		
526870	30/09/2022	(figurativa)	5 (Concedida S/D)	Boehringer Ingelheim International GmbH	136
526879	30/09/2022	RUDA (mixta)	35 (Concedida) y 25 (Concedida)	Fernando Díaz	212
526885	30/09/2022	KAYA HERBHOUSE	43 (Concedida), 41 (Concedida) y 35 (Concedida)	PROPERTIES MANAGEMENT S.A.	144
526886	30/09/2022	CASA KAYA	43 (Concedida)	PROPERTIES MANAGEMENT S.A.	144
526887	30/09/2022	KAYA BEACH HOUSE	43 (Concedida) y 41 (Concedida)	PROPERTIES MANAGEMENT S.A.	144
526888	30/09/2022	KAYA CAFÉ	43 (Concedida) y 41 (Concedida)	PROPERTIES MANAGEMENT S.A.	144
526889	30/09/2022	LUCKYLILY (mixta)	3 (Concedida S/D)	Yiwu Gaozhuo Import and Export Co., Ltd.	144
526890	30/09/2022	WMA (mixta)	12 (Concedida S/D)	WM SMART MOBILITY (SHANGHAI) CO., LTD.	144
526892	30/09/2022	TMKONNECT	45 (Concedida), 42 (Concedida) y 38 (Concedida)	TRADEMARKONNECTION, INC.	144
526894	30/09/2022	HACIENDA PREMIUM (mixta)	29 (Concedida)	TA -TA S.A.	245
526924	30/09/2022	POLIS	35 (Concedida)	ALEJANDRO BARBIERI GARCIA	104
526930	30/09/2022	N NOVUM (mixta)	5 (Concedida S/D)	LUMINOVA PHARMA CORPORATION GmbH	202
526931	30/09/2022	UN UNINOVA (mixta)	5 (Concedida S/D)	LUMINOVA PHARMA CORPORATION GmbH	202
526932	30/09/2022	KOALA (mixta)	20 (Concedida)	YP S.A.	34
526938	30/09/2022	ENVIGO	35 (Concedida)	Alejandro Casaretto	
526939	30/09/2022	SYZ (mixta)	36 (Concedida S/D)	Banque SYZ SA	201
526943	30/09/2022	SYZ (mixta)	36 (Concedida S/D)	Banque SYZ SA	201
526950	30/09/2022	WOOMAN	3 (Concedida)	GENOMMA LAB INTERNACIONAL, S.A.B. DE C.V.	245
526951	30/09/2022	CARBONAS	3 (Concedida)	GENOMMA LAB INTERNACIONAL, S.A.B. DE C.V.	245
526962	30/09/2022	(figurativa)	3 (Concedida)	GENOMMA LAB INTERNACIONAL, S.A.B.	245

N° Exp	Resolución	Marca	Clases	Titular	Ag.
				DE C.V.	

RESOLUCIONES DE FRASES PUBLICITARIAS, CONCEDIDAS

N° Exp	Resolución	Marca	Clases	Titular	Ag.
486699	16/09/2022	¿QUERÍAS PANCHOS? TOMÁ!	29 (Concedida)	FRIGORIFICO CENTENARIO S.A.	179
520920	09/09/2022	WHISKAS BUENO POR NATURALEZA	31 (Concedida S/D)	Mars, Incorporated	227
524129	02/09/2022	AHORREMOS EN SERIO	35 (Concedida)	TA -TA S.A.	245
524769	19/09/2022	LOVE SECRET LINGERIE NATURAL COMO VOCÊ (mixta)	25 (Concedida S/D)	LSB Indústrias de Confecções Ltda.	34
524903	09/09/2022	FRAGANCIAS CREADAS A CONCIENCIA	5 (Concedida S/D), 4 (Concedida S/D) y 3 (Concedida S/D)	S. C. JOHNSON & SON, INC.	194
524925	09/09/2022	DEL CLAPPER AL STARTUPER	41 (Concedida S/D)	Shai Abend	
525123	07/09/2022	ADUEÑATE DEL AIRE	5 (Concedida S/D), 4 (Concedida S/D) y 3 (Concedida S/D)	S. C. JOHNSON & SON, INC.	194
525404	09/09/2022	IDEAS A TU ALCANCE	35 (Concedida)	Mauricio Braica Alcalde; Nicolás Guggeri y Fabián Rial	212
525611	16/09/2022	ÍGNEA ENCIENDE TU LUZ (mixta)	35 (Concedida)	VILLAGRAN CABANNE MARIA JESUS Y GUICHON CABALLERO MARIANGELES SOCIEDAD DE HECHO	34
525639	13/09/2022	PONLE ROCKSTAR A TU DIA	32 (Concedida)	PEPSICO, INC.	201
525666	13/09/2022	IMPULSA TU TIENDA AL NUEVO NIVEL	42 (Concedida S/D), 38 (Concedida S/D), 35 (Concedida S/D) y 9 (Concedida S/D)	Coca-Cola FEMSA, S.A.B. de C.V.	216
525835	19/09/2022	LO QUERÉS, LO TENÉS	35 (Concedida)	ELIANA RAMOS	
526350	26/09/2022	TODOS MERECEMOS SER PROTEGIDOS	21 (Concedida S/D), 11 (Concedida S/D)	S. C. JOHNSON & SON, INC.	194

N° Exp	Resolución	Marca	Clases	Titular	Ag.
			y 5 (Concedida S/D)		
526378	21/09/2022	EMPEZA A TRANSPIRAR EL CLÁSICO	32 (Concedida)	STOKELY-VAN CAMP, INC.	201
526381	21/09/2022	PICAN PERO RICO	30 (Concedida) y 29 (Concedida)	PEPSICO, INC.	201
526560	29/09/2022	COMPRO EN MI PAIS	35 (Concedida)	CALVO VILLAVERDE, MABEL	201
526671	21/09/2022	EL ARROZ PREFERIDO DE LOS URUGUAYOS	30 (Concedida)	COOPAR S.A.	245

RESOLUCIONES DE MARCAS, DESESTIMADAS

N° Exp	Resolución	Marca	Clases	Titular	Ag.
441642	19/09/2022	MUNDIAL 2030	41 (Denegada), 38 (Denegada), 35 (Denegada), 25 (Denegada), 16 (Denegada) y 9 (Denegada)	SCASSO VOLONTE ALBERTO MARTIN	
441674	19/09/2022	MUNDIAL 2030 URUGUAY ARGENTINA 2030 WORLD CUP	45 (Denegada), 42 (Denegada), 32 (Denegada), 30 (Denegada), 16 (Denegada) y 12 (Denegada)	ALBERTO MARTIN SCASSO VOLONTE	
446355	21/09/2022	MUNDIAL 2030	45 (Denegada), 44 (Denegada), 43 (Denegada), 42 (Denegada), 39 (Denegada), 37 (Denegada), 36 (Denegada), 34 (Denegada)	ALBERTO MARTIN SCASSO VOLONTE	

N° Exp	Resolución	Marca	Clases	Titular	Ag.
			(Denegada), 33 (Denegada), 32 (Denegada), 31 (Denegada), 30 (Denegada), 29 (Denegada), 28 (Denegada), 27 (Denegada), 26 (Denegada), 24 (Denegada), 21 (Denegada), 20 (Denegada), 18 (Denegada), 14 (Denegada), 12 (Denegada), 11 (Denegada), 10 (Denegada), 8 (Denegada), 6 (Denegada), 4 (Denegada), 3 (Denegada) y 1 (Denegada)		
446356	21/09/2022	WORLD CUP 2030	45 (Denegada), 44 (Denegada), 43 (Denegada), 42 (Denegada), 41 (Denegada), 39 (Denegada), 38 (Denegada), 37 (Denegada), 36 (Denegada), 35	ALBERTO MARTIN SCASSO VOLONTE	

N° Exp	Resolución	Marca	Clases	Titular	Ag.
			(Denegada), 34 (Denegada), 33 (Denegada), 32 (Denegada), 31 (Denegada), 30 (Denegada), 29 (Denegada), 28 (Denegada), 27 (Denegada), 26 (Denegada), 25 (Denegada), 24 (Denegada), 21 (Denegada), 20 (Denegada), 18 (Denegada), 16 (Denegada), 14 (Denegada), 12 (Denegada), 11 (Denegada), 10 (Denegada), 9 (Denegada), 8 (Denegada), 6 (Denegada), 4 (Denegada), 3 (Denegada) y 1 (Denegada)		
489073	02/09/2022	PEDILO YA	38 (Denegada) y 35 (Denegada)	EDALSIR SOCIEDAD ANONIMA	
489849	16/09/2022	MINICHIVA (mixta)	28 (Denegada)	MATHIAS MAXIMILIANO MOSCARDI RODRIGUEZ; MAURICIO CASTELLO y JORGE ANDRÉS FERNANDEZ CENCIO	

N° Exp	Resolución	Marca	Clases	Titular	Ag.
489909	13/09/2022	FINANCIACIÓN AL TOQUE	36 (Denegada S/D)	SOCUR S.A.	194
490561	08/09/2022	NARANCHELO	32 (Denegada)	Portfolio Concentrate Solutions Unlimited Company	201
491029	13/09/2022	GUAPALETAS (mixta)	43 (Denegada) y 30 (Denegada)	AITABUENO S.R.L.	181
491221	16/09/2022	SPIN PISCINAS (mixta)	1 (Denegada S/D)	SPIN POOLS COSTA RICA S.A.	189
491522	30/09/2022	ODDI'S	29 (Denegada S/D)	ODDINO, LEANDRO JOSE	144
493612	28/09/2022	GOGREEN (mixta)	35 (Denegada) y 9 (Denegada)	DIGITAL WORLD SRL	212
494584	28/09/2022	ALTO DEL CARMEN	33 (Denegada S/D)	Cooperativa Agrícola Pisquera Elqui Limitada	221
497113	14/09/2022	CAPILET	5 (Denegada) y 3 (Denegada)	THE LATIN AMERICA TRADEMARK CORPORATION	144
497114	07/09/2022	CAPILET PRO	5 (Denegada) y 3 (Denegada)	THE LATIN AMERICA TRADEMARK CORPORATION	144
497333	30/09/2022	INNA	25 (Denegada)	Josefina Cáceres; Joaquín Cáceres y Juan Manuel Cáceres	165
498148	21/09/2022	ROZELAIC	3 (Denegada)	Mega Labs S.A.	217
498971	19/09/2022	PAÑALIN	5 (Denegada S/D)	P2-2S.A.	220
500632	16/09/2022	MT HELMETS (mixta)	9 (Denegada S/D)	MANUFACTURAS TOMAS, S.A.	34
501796	07/09/2022	VIÑAMAR DE CASABLANCA (mixta)	33 (Denegada S/D)	VIÑA ALTAIR S.P.A.	181
502081	08/09/2022	COMO EN CASA (mixta)	35 (Denegada S/D)	NUEVA ROSSELL S.R.L.	37
503167	07/09/2022	INDONESIA (mixta)	35 (Denegada)	MONTAÑES, ESTEBAN y MARCHESINI, DIEGO	
504214	16/09/2022	FLIGHT OF THE CONDOR	33 (Denegada S/D)	PERMASUR SA	34
504248	08/09/2022	LACTOSILO	1 (Denegada S/D)	BASF Corporation	144
504344	30/09/2022	X11 EXPERT RIDERS	25 (Denegada S/D)	SSC HOLDING LTD	216
504551	07/09/2022	ERO	9 (Denegada)	ROURE QUADRELLI IGNACIO JAVIER	144
504862	08/09/2022	HIOKI	9 (Denegada S/D)	HIOKI E.E. CORPORATION	94
504878	08/09/2022	ZENDAL (mixta)	35 (Denegada S/D)	CZ VETERINARIA, S.A	216
504884	19/09/2022	PREVID	5 (Denegada)	Laboratorios Richmond S.A.C.I.F	212

N° Exp	Resolución	Marca	Clases	Titular	Ag.
505343	19/09/2022	HIBRIDO	25 (Concedida)	JOSE LUIS DE CUNTO	
505345	19/09/2022	(figurativa)	25 (Denegada)	JOSE LUIS DE CUNTO	
505359	28/09/2022	SKY SHIVA KRIYA YOGA (mixta)	41 (Denegada)	Escuela de Valores Divinos	

RESOLUCIONES DE MARCAS, DESESTIMADAS (Art. 92, D. 34/999)

N° Exp	Resolución	Marca	Clases	Titular	Ag.
524833	06/09/2022	NO MIRES (mixta)	41 (Denegada)	CARLOS HEBER GOMEZ	
525593	15/09/2022	LA CASA DE LAS PIEDRAS (mixta)	14 (Denegada S/D)	Joan Manuel Leal	

RESOLUCIONES DE RENOVACIONES, DESESTIMADAS (Art. 92, D. 34/999)

N° Exp	Resolución	Marca	Clases	Titular	Ag.
495780	07/09/2022	CAPTIVATING COLOR POWERHOUSE SKIN CARE	35 (Denegada), 16 (Denegada) y 3 (Denegada)	MARY KAY INC.	144

RESOLUCIONES DE MARCAS, DESISTIDAS (Art. 90, D. 34/999)

N° Exp	Resolución	Marca	Clases	Titular	Ag.
523346	26/09/2022	HATSU	33 (Desistida S/D)	POSTOBON S.A.	181
523739	06/09/2022	MACONHA BEER R MACONHA BEER R (mixta)	32 (Desistida S/D)	MARCSOT SAS	
524772	19/09/2022	TURISTIQUE EXPERIENCIAS (mixta)	39 (Desistida) y 35 (Desistida)	Maria Julia Fernández Renna	212
525282	09/09/2022	MONSTERS VS VIRUS	9 (Desistida)	ASOCIACION URUGUAYA ORT	201
525288	09/09/2022	MEDCLINICAL	3 (Desistida S/D)	SAGRIN SOCIEDAD ANÓNIMA	189
525870	21/09/2022	BTL EMSELLA R MONTEVIDEO BY M&D (mixta)	44 (Desistida)	OSVALDO LUIS MACHADO RIGAU	
526002	19/09/2022	CASA DONOSO	33 (Desistida)	MARIO H VIDALES & CIA. S.C.	201
526098	30/09/2022	LISA BURGER & DRINKS	43 (Desistida)	ABUTOR S.A.	118
526156	20/09/2022	ZACTILBI	5 (Desistida S/D)	NOVARTIS AG.	201

RESOLUCIONES DE MARCAS, DESISTIDAS (Art. 92, D. 34/999)

N° Exp	Resolución	Marca	Clases	Titular	Ag.
430810	02/09/2022	ALTAGRAZZI (mixta)	25 (Desistida)	REIMIX SA	
512596	05/09/2022	DENTAL RESTYLING	44 (Desistida S/D)	Andrea Giani	
516698	05/09/2022	INSUMOS CULTIVADOR SOLUCIONES PARA TU JARDIN (mixta)	35 (Desistida S/D), 34 (Desistida S/D), 31 (Desistida S/D), 5 (Desistida S/D) y 1 (Desistida S/D)	INSUMOS CULTIVADOR SRL	
518691	02/09/2022	L'ORIGEN	25 (Desistida S/D)	Melina Piperno	
518858	05/09/2022	NEWBLUE URUGUAY (mixta)	4 (Desistida) y 1 (Desistida)	enrique mendiondo	
518950	05/09/2022	SAN CARLOS SEGUROS (mixta)	36 (Desistida)	Sergio Sebastian Rieiro	172
519794	19/09/2022	GUSTAVO NUÑEZ 100 AÑOS (mixta)	20 (Desistida)	GUSTAVO NUÑEZ MUÑOZ	
520916	27/09/2022	TINY HOUSE URUGUAY (mixta)	42 (Desistida S/D) y 37 (Desistida S/D)	Joaquín Rodiño	
522183	29/09/2022	CEMLAST	19 (Desistida)	CIMSA	172
524693	02/09/2022	LA BOHEME	1 (Desistida S/D)	Gaston Acosta y Karen Judith Espiga	
525290	21/09/2022	TALAGORRA (mixta)	23 (Desistida S/D)	Santiago Posse	
525386	19/09/2022	AQUASHOP	19 (Desistida), 11 (Desistida), 7 (Desistida) y 6 (Desistida)	Hidromecánica Lesa S.A. y Gustavo Lema	
525390	19/09/2022	AQUAPRO	19 (Desistida), 11 (Desistida), 7 (Desistida) y 6 (Desistida)	Hidromecánica Lesa S.A. y Gustavo Lema	
526644	30/09/2022	MAKI SUSHI (mixta)	43 (Desistida S/D)	Gonzalo Amarelle	

RESOLUCIONES DE MARCAS, MODIFICADAS

N° Exp	Resolución	Marca	Clases	Notas	Ag.
493270	14/09/2022	WABI (mixta) / ELIS CARLA PARODI CAYAFA	35 (Denegada) y 25 (Denegada)		
499782	05/09/2022	KING MIX (mixta) / BRAVEN FOODS LTDA.	30 (Concedida S/D)		201
501653	02/09/2022	KITTY SAN KITTY SAN (mixta) / ECOMIN S.R.L	5 (Pendiente)		184
515814	13/09/2022	GLAPS GLOBAL AESTHETICS PRODUCTS & SERVICES (mixta) / GLOBAL AESTHETICS PRODUCTS AND SERVICES S.R.L.	10 (Concedida)		219
517058	27/09/2022	BAYER BAYER (mixta) / Bayer Aktiengesellschaft	44 (Concedida S/D), 42 (Concedida S/D), 41 (Concedida S/D), 35 (Concedida S/D), 31 (Concedida S/D), 10 (Concedida S/D), 9 (Concedida S/D), 5 (Concedida S/D), 3 (Concedida S/D) y 1 (Concedida S/D)		218
521512	30/09/2022	LAUFENN S FIT EQ (mixta) / HANKOOK & COMPANY CO., LTD.	12 (Concedida S/D)		201
521514	30/09/2022	LAUFENN G FIT EQ (mixta) / HANKOOK & COMPANY CO., LTD.	12 (Concedida S/D)		201
523834	02/09/2022	PARA-GENIOL / URUFARMA S.A.	5 (Concedida)		34
523836	02/09/2022	NOVOGENIOL / URUFARMA S.A.	5 (Concedida)		34
523838	02/09/2022	GENIOL INFANTIL / URUFARMA S.A.	5 (Concedida)		34
523839	02/09/2022	GENIOLITO / URUFARMA S.A.	5 (Concedida)		34

N° Exp	Resolución	Marca	Clases	Notas	Ag.
523979	08/09/2022	PRIME (mixta) / Amazon Technologies, Inc.	39 (Concedida S/D), 36 (Concedida S/D), 35 (Concedida S/D) y 9 (Concedida S/D)		136
524362	07/09/2022	JONES & CIA. S.A. / JONES & CIA. S.A.	45 (Concedida)		192
524713	26/09/2022	RECETAS ¡QUÉ RICO! (mixta) / HENDERSON & CIA. S.A.	41 (Concedida) y 35 (Concedida)		181

RESOLUCIONES DE RENOVACIONES, MODIFICADAS

N° Exp	Resolución	Marca	Clases	Notas	Ag.
501747	14/09/2022	JOCKEY / Jockey Internacional, Inc.	25 (Concedida S/D)		194

RESOLUCIONES DE RENOVACIONES, ANULADAS

N° Exp	Resolución	Marca	Clases	Notas	Ag.
444394	26/09/2022	TCI (mixta)	42 (Anulada) y 9 (Anulada)	LUIS MARIO DECIA y ROBERTO SIOSTEDT	220
469868	16/09/2022	TUSILISIN	5 (Anulada S/D)	LAZAR S.A.	204
494736	09/09/2022	CLENPULMIN	5 (Anulada)	LABORATORIO ION S.A.	201

RESOLUCIONES DE RENOVACIONES, CONCEDIDAS

N° Exp	Resolución	Denominación	Clases	Titular	Vigencia	Ag.
500367	20/09/2022	MAGNA VIDA+BENEFICIOS (mixta)	36 (S/D)	Compañía Cooperativa de Seguros Surco	22/05/2018	174
500369	20/09/2022	EL FUTURO EN BUENAS MANOS	36 (S/D)	Compañía Cooperativa de Seguros Surco	30/07/2018	174
500608	27/09/2022	BAMBU	33	LANECOR S.A.	09/01/2019	219
503668	23/09/2022	ROBE DI KAPPA	3 (S/D) y 25 (S/D)	BASIC TRADEMARK S.A.	22/04/2019	165
503669	23/09/2022	(figurativa)	3 (S/D), 9 (S/D), 18 (S/D), 25 (S/D) y 28 (S/D)	BASIC TRADEMARK S.A.	22/04/2019	165

N° Exp	Resolución	Denominación	Clases	Titular	Vigencia	Ag.
503671	23/09/2022	KAPPA	3 (S/D), 9 (S/D), 18 (S/D), 25 (S/D) y 28 (S/D)	BASIC TRADEMARK S.A.	22/04/2019	165
503672	23/09/2022	ROBE DI KAPPA (mixta)	9, 18 y 28	BASIC TRADEMARK S.A.	26/08/2019	165
508241	13/09/2022	GAMESA	30	CORPORATIVO INTERNACIONAL MEXICANO, S.DE R.L.DE C.V.	04/10/2019	201
509583	29/09/2022	FOAMGLAS (mixta)	17 (S/D)	Owens Corning Intellectual Capital, LLC	30/11/2019	136
512728	27/09/2022	WONPRO	9 y 11	SYLVIA KATZ	21/07/2020	
512794	07/09/2022	SWEET'N LOW	5	CUMBERLAND PACKING CORP.	05/05/2020	216
512795	07/09/2022	SUGAR IN THE RAW (mixta)	30 (S/D)	CUMBERLAND PACKING CORP.	30/08/2020	216
513527	12/09/2022	TRIUMPH (mixta)	3 (S/D), 25 (S/D) y 35 (S/D)	Triumph Intertrade AG	20/07/2020	240
515391	28/09/2022	C & M LTD. (mixta)	36	Hector Eduardo Mendez Donazar	03/07/2020	104
515595	28/09/2022	PALABRA DE VIDA	38	LA IGLESIA UNIVERSAL DEL REINO DE DIOS	11/07/2020	201
515599	28/09/2022	PARE DE SUFRIR	16 y 38	LA IGLESIA UNIVERSAL DEL REINO DE DIOS	11/07/2020	201
515603	28/09/2022	JESUCRISTO ES EL SEÑOR IGLESIA UNIVERSAL DEL REINO DE DIOS	41	LA IGLESIA UNIVERSAL DEL REINO DE DIOS	11/07/2020	201
517181	06/09/2022	SUPERCAN	31 (S/D)	SAN FRANCISCO C.I.S.A.	08/09/2020	154
518997	29/09/2022	ACTION MAN	9, 16, 28, 41 y 42	HASBRO INTERNATIONAL, INC.	17/01/2021	212
519034	06/09/2022	CIUDADELA (mixta)	33	reinaldo de lucca	17/01/2021	129
519340	28/09/2022	ALTO DE LA BALLENA	33	DORILAR S.A.	13/05/2020	
519422	06/09/2022	EQUASYM	5 (S/D)	SHIRE PHARMACEUTICALS IRELAND LIMITED	28/12/2020	34
519797	28/09/2022	COSEM MUTUALISTA SEMM (mixta)	44	Cosem Iampp	14/12/2020	101
519840	29/09/2022	PARQUE DE LAS CIENCIAS	35	Parque de las Ciencias S.A	24/02/2021	144
519842	29/09/2022	PARQUE DE LAS CIENCIAS	36	Parque de las Ciencias S.A	24/02/2021	144
519843	29/09/2022	PARQUE DE LAS CIENCIAS	38	Parque de las Ciencias S.A	24/02/2021	144
519844	29/09/2022	PARQUE DE LAS CIENCIAS	39	Parque de las Ciencias S.A	25/02/2021	144

N° Exp	Resolución	Denominación	Clases	Titular	Vigencia	Ag.
519845	29/09/2022	PARQUE DE LAS CIENCIAS	42	Parque de las Ciencias S.A	25/02/2021	144
519847	29/09/2022	PARQUE DE LAS CIENCIAS	44	Parque de las Ciencias S.A	25/02/2021	144
519848	29/09/2022	EL PARQUE	35	Parque de las Ciencias S.A	02/03/2021	144
520079	28/09/2022	MURILLO RUFFINELLI MOREIRA MRM (mixta)	35, 36 y 39	MURILLO. RUFFINELLI. MOREIRA. S.R.L.	26/04/2021	94
520087	29/09/2022	VISUCLAR	5	LABORATORIO ELEA PHOENIX S.A.	26/01/2021	34
520126	29/09/2022	V- KOOL (mixta)	17	SOLUTIA SINGAPORE PTE.LTD.	17/01/2021	216
520245	06/09/2022	OLD CHRISTIANS CLUB (mixta)	25	OLD CHRISTIANS CLUB	09/02/2021	154
520249	09/09/2022	AQUAPHOR	3 (S/D) y 5 (S/D)	BEIERSDORF AG	18/01/2021	201
520631	09/09/2022	BOUCHARD PÈRE & FILS	33 (S/D)	MAISON BOUCHARD PERE ET FILS	31/01/2021	144
520703	07/09/2022	IL PANINO (mixta)	43	BOLIVAR S.R.L.	19/02/2021	201
520735	31/08/2022	SPEEDO	25 (S/D)	SPEEDO HOLDINGS B.V.	21/01/2021	194
520853	31/08/2022	ESPLENDOR (mixta)	43 y 44	WYNDHAM HOTEL MANAGEMENT de ARGENTINA SRL	08/04/2021	245
520922	09/09/2022	MOVIDAMIX	38	Gustavo Tagliabue Rico	30/03/2021	201
520956	31/08/2022	UDEPU, TIENDA DE MARCAS, URUGUAY SE MUESTRA (mixta)	35 y 41	Gracie Rodríguez	24/05/2021	186
521028	01/09/2022	ECONOMY PLUS	39	UNITED AIRLINES, INC.	30/01/2021	194
521084	01/09/2022	CUORI	7, 9, 11 y 21	FORTUNE S.A.	08/02/2021	189
521116	07/09/2022	EUROPAMUNDO VACACIONES (mixta)	39 y 43	EUROPA MUNDO VACACIONES, S.L.	29/03/2021	144
521145	01/09/2022	ATHIX (mixta)	25	BLANCO, MATÍAS	10/02/2021	189
521257	02/09/2022	PERSONNA COMFORT	8 (S/D)	EDGEWELL PERSONAL CARE BRANDS, LLC	09/03/2021	194
521302	07/09/2022	BELARA	5 (S/D)	Richter Gedeon Nyrt.	15/06/2021	219
521364	08/09/2022	TIERRA COMPOST JF JARDIFERT (mixta)	1	KRYZANOWSKI, MIGUEL ANGEL	23/03/2021	194
521385	31/08/2022	FELINO	33	VIÑA COBOS S.A.	18/02/2021	34
521387	31/08/2022	SALUS CERVEZA PATRICIA (mixta)	32 (S/D)	FNC SOCIEDAD ANONIMA	05/04/2021	144
521393	31/08/2022	BRAMARE	33	VIÑA COBOS S.A.	19/07/2021	34

N° Exp	Resolución	Denominación	Clases	Titular	Vigencia	Ag.
521395	31/08/2022	SALUS CERVEZA NEGRA PATRICIA (mixta)	32 (S/D)	FNC SOCIEDAD ANONIMA	05/04/2021	144
521396	31/08/2022	SALUS CERVEZA PATRICIA (mixta)	32 (S/D)	FNC SOCIEDAD ANONIMA	05/04/2021	144
521400	31/08/2022	AMISOS PREVENT	5	Mega Labs S.A.	04/03/2021	144
521401	31/08/2022	BLUE (mixta)	3	LABORATORIOS CELSIUS S.A.	06/03/2021	144
521402	31/08/2022	DERMUR (mixta)	3 y 5	LABORATORIOS CELSIUS S.A.	28/03/2021	144
521403	31/08/2022	ETRUX	5	LABORATORIOS CELSIUS S.A.	18/03/2021	144
521404	31/08/2022	FANUCID CELSIUS	5 (S/D)	LABORATORIOS CELSIUS S.A.	12/03/2021	144
521407	31/08/2022	GLAUTIMOL	5	LABORATORIOS CELSIUS S.A.	22/03/2021	144
521408	31/08/2022	PRIAXIM CELSIUS	5	LABORATORIOS CELSIUS S.A.	07/03/2021	144
521409	31/08/2022	QUICKSEAL	5	LABORATORIOS HAYMANN S.A.	25/04/2021	144
521410	31/08/2022	SOLNEF	5 (S/D)	Mega Labs S.A.	31/03/2021	144
521411	31/08/2022	TALOF POEN	5 (S/D)	Mega Labs S.A.	28/03/2021	144
521412	31/08/2022	TONOTIL	5 (S/D)	LABORATORIOS CELSIUS S.A.	29/04/2021	144
521414	31/08/2022	VITIA	3	LABORATORIOS CELSIUS S.A.	02/03/2021	144
521415	31/08/2022	SEDUCTION IN BLACK	3	Antonio Puig, S.A.	25/04/2021	144
521418	31/08/2022	ALURUGUAY (mixta)	6 (S/D), 16 y 19	ALUMINIOS DEL URUGUAY S.A.	01/03/2021	212
521419	31/08/2022	ALURUGUAY (mixta)	6 (S/D), 16 y 19	ALUMINIOS DEL URUGUAY S.A.	11/07/2021	212
521422	31/08/2022	MERRILL	36 (S/D)	Bank of America Corporation	04/03/2021	194
521428	01/09/2022	DI DROGUERIA INDUSTRIAL URUGUAYA EMILIO BENZO S.A. (mixta)	1, 3, 4, 5 y 35	EMILIO BENZO S.A.	29/03/2021	194
521429	01/09/2022	SWIM (mixta)	1 y 5 (S/D)	EMILIO BENZO S.A.	31/03/2021	194
521431	01/09/2022	LA LIGURIA	29, 30, 31, 32, 33, 35 (S/D), 41 y 43	MIGUEL ANGEL SCALTRITTI	22/02/2021	
521432	01/09/2022	KNOWLEDGE GROWS	1, 16 y 44	YARA INTERNATIONAL ASA	14/02/2021	201
521438	01/09/2022	BLACK JACK	28 (S/D)	ALISUL ALIMENTOS S.A.	28/02/2021	245
521439	01/09/2022	GINGILACER	3	LACER S.A.	23/03/2021	245
521440	01/09/2022	PERIOXIDIN	3	LACER S.A.	23/03/2021	245
521442	01/09/2022	SENSILACER	3	LACER S.A.	23/03/2021	245

N° Exp	Resolución	Denominación	Clases	Titular	Vigencia	Ag.
521457	01/09/2022	COTONIFICIO FIACAO PEDREIRA (mixta)	23 (S/D) y 24 (S/D)	COTONIFICIO FIACAO PEDREIRA LTDA	09/03/2021	144
521459	01/09/2022	DIAGEO	16 (S/D), 29, 30, 31, 32, 33 (S/D), 35 y 43 (S/D)	DIAGEO PLC	21/02/2021	212
521461	01/09/2022	DORMEUIL	24 (S/D) y 25 (S/D)	DORMEUIL FRERES	26/04/2021	212
521462	01/09/2022	COFLEX	6 (S/D), 11 (S/D) y 35 (S/D)	COFLEX S.A. DE C.V.	10/08/2021	181
521465	01/09/2022	HOSTASIN	2 (S/D)	HOECHST GMBH	22/03/2021	194
521467	01/09/2022	(figurativa)	7 (S/D) y 12 (S/D)	DETROIT DIESEL CORPORATION	22/03/2021	194
521471	01/09/2022	CHORIPRON	29	Establecimientos Juan Sarubbi S.A.	24/01/2021	154
521473	01/09/2022	GABIROL	5	PRODUCTOS FARMACEUTICOS, S.A. DE C.V.	11/06/2021	34
521474	01/09/2022	BAHIA	32 y 33	INDUSTRIAS BAHIA S.A.	10/08/2021	245
521476	01/09/2022	EDUCARD	36	SANTIAGO JOSE OTEGUI VILARO	07/06/2021	34
521479	01/09/2022	ZEVTERA	5 (S/D)	BASILEA PHARMACEUTICA INTERNATIONAL LTD.	28/04/2021	218
521484	01/09/2022	TARJETA REGALO OCA	36	OCA S.A.	18/01/2021	245
521485	02/09/2022	NOBLE	6	INCUER S.A.	22/02/2021	245
521488	02/09/2022	PRUDENTIAL FINANCIAL (mixta)	36	THE PRUDENTIAL INSURANCE COMPANY OF AMERICA	24/05/2021	144
521489	02/09/2022	STADA	5	STADA ARZNEIMITTEL AG	03/05/2021	179
521491	02/09/2022	LADIVAL	3	STADA ARZNEIMITTEL AG	10/05/2021	179
521492	02/09/2022	GALDEN	1 (S/D) y 4 (S/D)	SOLVAY SPECIALTY POLYMERS ITALY, S.p.A.	18/04/2021	144
521496	02/09/2022	ZANOTTI	26	ZANOTTI INDÚSTRIA E COMÉRCIO LTDA.	24/02/2021	163
521498	02/09/2022	LAUFEN (mixta)	11, 19, 20 y 21	Keramik Holding AG Laufen	21/02/2021	136
521499	02/09/2022	BURGER KING (mixta)	16 (S/D) y 28 (S/D)	Burger King Corporation	10/10/2020	136
521501	02/09/2022	(figurativa)	37 (S/D)	GENERAL MOTORS LLC	03/03/2021	136
521502	02/09/2022	SKIP DEVUELVE VIDA A TU ROPA	3	Unilever Global IP Limited	24/05/2021	136

N° Exp	Resolución	Denominación	Clases	Titular	Vigencia	Ag.
521503	02/09/2022	DEXA-DOCEPLEX	5	LABORATORIOS VIJOSA S.A. DE C.V.	09/08/2021	201
521505	02/09/2022	JAMES DEAN	25	JAMES DEAN, INC. (UNA CORPORACION DE INDIANA)	21/02/2021	201
521506	02/09/2022	TRES PLUMAS (mixta)	32 (S/D) y 33 (S/D)	CASA DELLEPIANE Y CIA. S.A.C.I.I. Y FINANCIERA	22/03/2021	201
521507	02/09/2022	GRANJA DEL SOL (mixta)	5, 32, 33 y 42	MOLINOS IP S.A.	09/08/2021	34
521508	02/09/2022	INTERAG (mixta)	1, 5, 31, 35, 42 y 44	INTERAG S.A.	29/07/2021	94
521509	02/09/2022	VULCAN (mixta)	11 (S/D)	HOBART LLC	22/02/2021	34
521510	02/09/2022	(figurativa)	32 (S/D)	EUROPEAN REFRESHMENTS	20/04/2021	94
521516	02/09/2022	PYR O REY	21	Crisa Libbey Mexico, S. de R.L. de C.V.	16/03/2021	34
521519	02/09/2022	CRISA (mixta)	21 (S/D)	Crisa Libbey Mexico, S. de R.L. de C.V.	16/03/2021	34
521520	02/09/2022	DUPROST SERVIMEDIC	5	SERVIMEDIC S.A.	07/04/2021	144
521521	02/09/2022	SHOCK D	5	PHARMOS S.A.	05/04/2021	144
521522	02/09/2022	DRAY	29 y 30	MIS BAÑADOS SA	16/07/2021	144
521523	02/09/2022	COLORISSIMOS	3 (S/D)	L'OREAL	15/07/2021	144
521524	02/09/2022	LIBBEY	21	LIBBEY GLASS INC.	16/03/2021	34
521526	05/09/2022	AMBITIONS	3 (S/D)	Compañía Uruguaya Distribuidora de Exclusividades S.A. CUDESA	18/04/2021	144
521527	05/09/2022	GUANTANAMERA	34	CORPORACION HABANOS, S.A.	13/07/2021	144
521528	05/09/2022	T (mixta)	38 y 41	MONTE CARLO T.V. S.A.	07/04/2021	144
521529	05/09/2022	TOYOTA RAV4	12	TOYOTA JIDOSHA KABUSHIKI KAISHA (TOYOTA MOTOR CORPORATION)	11/07/2021	144
521530	05/09/2022	H HOLIDAY INN CLUB VACATIONS (mixta)	36 (S/D) y 43 (S/D)	SIX CONTINENTS HOTELS, INC.	03/03/2021	34
521531	05/09/2022	(figurativa)	6 (S/D)	TELEDYNE TECHNOLOGIES INCORPORATED	05/07/2021	144
521532	05/09/2022	(figurativa)	7 (S/D)	TELEDYNE TECHNOLOGIES INCORPORATED	05/07/2021	144
521533	05/09/2022	(figurativa)	9 (S/D)	TELEDYNE TECHNOLOGIES INCORPORATED	05/07/2021	144

N° Exp	Resolución	Denominación	Clases	Titular	Vigencia	Ag.
521534	05/09/2022	(figurativa)	9 (S/D)	TELEDYNE TECHNOLOGIES INCORPORATED	05/07/2021	144
521535	05/09/2022	TELEDYNE	9 (S/D)	TELEDYNE TECHNOLOGIES INCORPORATED	05/07/2021	144
521536	05/09/2022	TELEDYNE	9 (S/D)	TELEDYNE TECHNOLOGIES INCORPORATED	05/07/2021	144
521537	05/09/2022	HOLIDAY INN CLUB	36 (S/D) y 43 (S/D)	SIX CONTINENTS HOTELS, INC.	02/03/2021	34
521538	05/09/2022	TELEDYNE	9 (S/D)	TELEDYNE TECHNOLOGIES INCORPORATED	05/07/2021	144
521539	05/09/2022	DIMATEX	5	BALIARDA S.A.	21/02/2021	201
521540	05/09/2022	ROTARY LIFT	7 (S/D)	VEHICLE SERVICE GROUP, LLC	12/08/2021	144
521541	05/09/2022	ROTARY (mixta)	7 (S/D)	VEHICLE SERVICE GROUP, LLC	12/08/2021	144
521542	05/09/2022	PRU ROCK-SOLID ECO-SMART (mixta)	36	THE PRUDENTIAL INSURANCE COMPANY OF AMERICA	12/04/2021	144
521543	05/09/2022	WYPALL	16 (S/D) y 21 (S/D)	KIMBERLY-CLARK WORLDWIDE, INC	23/03/2021	34
521544	05/09/2022	TRIPP LITE	9	TRIPPE MANUFACTURING COMPANY	19/02/2021	201
521548	05/09/2022	RADESCA (mixta)	9 (S/D)	JUAN J. RADESCA S.A.	05/07/2021	165
521549	05/09/2022	FANGAN	5	LAZAR S.A.	07/04/2021	165
521552	05/09/2022	INTEL	28	INTEL CORPORATION	21/02/2021	245
521553	05/09/2022	GRAINGER	9, 16 y 35	W.W. GRAINGER INC.	28/11/2020	245
521555	05/09/2022	SENSACION (mixta)	30	MONDELEZ URUGUAY S.A.	22/02/2021	245
521556	05/09/2022	HEIDELBERG (mixta)	1 (S/D), 2 (S/D), 16 (S/D), 21 (S/D), 35 (S/D), 36 (S/D), 37 (S/D), 41 (S/D) y 42 (S/D)	HEIDELBERGER DRUCKMASCHINEN AG	08/05/2021	240
521559	06/09/2022	FOMOCO (mixta)	1 (S/D), 4 (S/D), 6 (S/D), 7 (S/D) y 9 (S/D)	FORD MOTOR COMPANY	12/06/2021	194

N° Exp	Resolución	Denominación	Clases	Titular	Vigencia	Ag.
521560	06/09/2022	FOMOCO (mixta)	7 (S/D), 12 (S/D) y 22 (S/D)	FORD MOTOR COMPANY	12/06/2021	194
521562	06/09/2022	FOMOCO (mixta)	7 (S/D), 8 (S/D), 9 (S/D), 11 (S/D), 14 (S/D) y 17 (S/D)	FORD MOTOR COMPANY	12/06/2021	194
521563	06/09/2022	AXION SENSACION PRIMAVERAL	3	COLGATE-PALMOLIVE COMPANY	09/03/2021	201
521564	06/09/2022	ECOBOOST	12 (S/D)	FORD MOTOR COMPANY	15/06/2021	194
521565	06/09/2022	COLGATE MAXIMUM CAVITY PROTECTION GREAT REGULAR FLAVOR (mixta)	3	COLGATE-PALMOLIVE COMPANY	09/03/2021	201
521566	06/09/2022	COLGATE MAXIMUM CAVITY PROTECTION GREAT REGULAR FLAVOR (mixta)	3	COLGATE-PALMOLIVE COMPANY	09/03/2021	201
521567	06/09/2022	CREMA DE AFEITAR PALMOLIVE (mixta)	3 (S/D)	COLGATE-PALMOLIVE COMPANY	22/03/2021	201
521570	06/09/2022	PERFEMMA	5 (S/D)	UNIVERSAL CORPORATE TRADE MARKS LLP	17/03/2021	218
521572	06/09/2022	BIOKERA (mixta)	3	HOLPINDUS, S.L.	22/06/2021	34
521573	06/09/2022	PATRICK	11	CONTROLADORA MABE, S.A. DE C.V.	18/04/2021	94
521577	06/09/2022	RENNER (mixta)	2 (S/D)	RENNER SAYERLACK S.A.	18/03/2021	34
521579	06/09/2022	ALSAMAR	29 (S/D)	BUNGE ARGENTINA S.A.	21/02/2021	245
521580	06/09/2022	BUTOXYL	1 (S/D)	CELANESE SALES GERMANY GmbH	22/03/2021	34
521581	06/09/2022	ACCORD	7 (S/D), 12 (S/D) y 22 (S/D)	HONDA GIKEN KOGYO KABUSHIKI KAISHA	26/04/2021	94
521582	06/09/2022	V (mixta)	6	Valvosanitaria Bugatti S.P.A	28/02/2021	212
521584	06/09/2022	BUGATTI V WATERWORKS (mixta)	6	Valvosanitaria Bugatti S.P.A	28/02/2021	212
521585	06/09/2022	BUGATTI V VALVOSANITARIA (mixta)	6	Valvosanitaria Bugatti S.P.A	31/05/2021	212
521589	06/09/2022	(figurativa)	25	adidas AG	29/03/2021	34
521590	06/09/2022	(tridimensional)	33	SOCIETE JAS HENNESSY & CO.	22/06/2021	165

N° Exp	Resolución	Denominación	Clases	Titular	Vigencia	Ag.
521591	06/09/2022	(figurativa)	25	adidas AG	29/03/2021	34
521593	06/09/2022	(figurativa)	25	adidas AG	29/03/2021	34
521595	06/09/2022	BOXIDRA	5	GLAXO GROUP LIMITED	24/03/2021	216
521596	06/09/2022	ENVALIO	5	GLAXO GROUP LIMITED	24/03/2021	216
521598	06/09/2022	NIMENRIX	5 (S/D)	GlaxoSmithKline Biologicals S.A.	28/03/2021	216
521599	06/09/2022	NEIBARIX	5 (S/D)	GlaxoSmithKline Biologicals S.A.	28/03/2021	216
521600	06/09/2022	BACMENRIX	5 (S/D)	GlaxoSmithKline Biologicals S.A.	24/03/2021	216
521601	06/09/2022	GSK (mixta)	1 (S/D), 3 (S/D), 5 (S/D), 9 (S/D), 10 (S/D), 16 (S/D), 21 (S/D), 29 (S/D), 30 (S/D), 32 (S/D), 35 (S/D), 41 (S/D), 42 (S/D) y 44 (S/D)	SmithKline Beecham Limited	08/03/2021	216
521602	06/09/2022	GSK (mixta)	1 (S/D), 3 (S/D), 5 (S/D), 9 (S/D), 10 (S/D), 16 (S/D), 21 (S/D), 29 (S/D), 30 (S/D), 32 (S/D), 35 (S/D), 41 (S/D), 42 (S/D) y 44 (S/D)	SmithKline Beecham Limited	08/03/2021	216
521603	07/09/2022	GSK	1 (S/D), 3 (S/D), 5 (S/D), 9 (S/D), 16 (S/D), 21 (S/D), 29 (S/D), 30 (S/D), 32 (S/D), 41 (S/D), 42 (S/D) y 44 (S/D)	SmithKline Beecham Limited	08/03/2021	216
521604	07/09/2022	GLAXO SMITHKLINE	1 (S/D), 3 (S/D), 5 (S/D), 9 (S/D), 16 (S/D), 21 (S/D), 29 (S/D), 30 (S/D), 32	SmithKline Beecham Limited	08/03/2021	216

N° Exp	Resolución	Denominación	Clases	Titular	Vigencia	Ag.
			(S/D), 41 (S/D), 42 (S/D) y 44 (S/D)			
521607	07/09/2022	SUCRODEX	1 y 30	Corn Products Development, Inc.	08/03/2021	216
521610	07/09/2022	EXPLORA (mixta)	25	EXPLORA INDUMENTARIA S.R.L.	21/02/2021	220
521613	07/09/2022	AIR KING R (mixta)	11	LASKO OPERATION HOLDINGS, LLC.	02/08/2021	234
521616	07/09/2022	AMEX	36 y 39	AMERICAN EXPRESS MARKETING & DEVELOPMENT CORP.	23/05/2021	144
521621	07/09/2022	FESTINA (mixta)	14 (S/D)	FESTINA LOTUS, S.A.	15/03/2021	34
521622	07/09/2022	PINO AMERICANO	19 y 31	JUAN C. BALERIO S.A.	27/06/2021	201
521623	07/09/2022	POMELLATO (mixta)	3 y 14	POMELLATO S.P.A.	04/03/2021	201
521624	07/09/2022	AMRITA (mixta)	41	BEHRENS MUNIZ, CARINA	04/03/2021	245
521627	07/09/2022	DORMICUM	5	Siegfried Rhein S.A. de C.V.	21/08/2021	201
521628	07/09/2022	VOLTAREN (mixta)	5 (S/D)	NOVARTIS AG	23/08/2021	201
521629	07/09/2022	LOS DOMINGUEZ	25, 29, 30 y 35	Celso Domínguez Villarino y Zulma Elisa Ortas García	27/05/2021	218
521630	07/09/2022	LA NEVADA	35 (S/D)	ROSARIO GRASSI y JOSE PABLO GRASSI	11/03/2021	160
521632	07/09/2022	DEKNATEL	10	Teleflex Medical Incorporated	18/03/2021	194
521640	07/09/2022	ESPASMOCALM	5	LAZAR S.A.	27/05/2021	144
521645	07/09/2022	MUSIC FAN	3 (S/D)	Unilever Global IP Limited	09/05/2021	136
521647	08/09/2022	FORTEMIN	5 (S/D)	Laboratorios Calier de Uruguay S.A	22/08/2021	212
521649	08/09/2022	F FERNCO INC. (mixta)	6 (S/D)	Fernco, Inc.	07/04/2021	136
521650	08/09/2022	MEGATON L.A.	5	Laboratorios Calier de Uruguay S.A.	22/08/2021	212
521656	08/09/2022	WIX	7 (S/D)	MANN+HUMMEL Filtration Technology US LLC	19/03/2021	194
521657	08/09/2022	KOOL	34	British American Tobacco (Brands) Inc.	23/03/2021	194
521659	08/09/2022	AEROMÁS (mixta)	39 (S/D)	DALMAS GARCEN, OCTAVIO DANIEL	08/03/2021	189
521660	08/09/2022	ALLO 100	5	ANTIA MOLL Y CIA. S.A.	10/03/2021	201
521663	08/09/2022	BIVACT	5 (S/D)	BOEHRINGER INGELHEIM	18/03/2021	201

N° Exp	Resolución	Denominación	Clases	Titular	Vigencia	Ag.
				VETMEDICA GMBH		
521664	08/09/2022	YO PUEDO	32 (S/D)	PEPSICO, INC. UNA CORPORACIÓN DEL ESTADO DE CAROLINA DEL NORTE	14/03/2021	201
521665	08/09/2022	TELEFONICA MOVILES	9, 35 y 38	TELEFONICA, S.A.	01/03/2021	201
521667	08/09/2022	451 COLONIA INGLESA (mixta)	3	LABORATORIO DURANDIN S.A.I.	27/05/2021	181
521669	08/09/2022	ZOE	12 (S/D)	RENAULT S.A.S.	10/03/2021	201
521670	08/09/2022	RENAULT PASSENGER	12	RENAULT S.A.S.	29/03/2021	201
521671	08/09/2022	MODAFILO DISPERT	5	LABORATORIOS DISPERT S.A.	21/03/2021	201
521675	08/09/2022	TOPACIO (mixta)	20 y 24	MENTVIL S.A.	11/03/2021	201
521676	08/09/2022	ALCON ECO CLUB (mixta)	31 (S/D)	IND. E COM. DE ALIMENTOS DESIDRATADOS ALCON LTDA.	25/07/2021	245
521679	08/09/2022	ALCON ECO CLUB	31 (S/D)	IND. E COM. DE ALIMENTOS DESIDRATADOS ALCON LTDA.	26/05/2021	245
521681	08/09/2022	ALCONPET	31 (S/D)	IND. E COM. DE ALIMENTOS DESIDRATADOS ALCON LTDA.	26/05/2021	245
521688	08/09/2022	MARY KAY CALMING INFLUENCE	3 (S/D)	MARY KAY INC.	27/06/2021	144
521689	08/09/2022	ANIOS	5	Ecolab USA Inc.	20/04/2021	144
521691	08/09/2022	SUPERTURISMO AUV ASOCIACION URUGUAYA DE VOLANTES (mixta)	41	ASOCIACION URUGUAYA DE VOLANTES	04/03/2021	163
521692	08/09/2022	TURISMO LIBRE AUV ASOCIACION URUGUAYA DE VOLANTES (mixta)	41	ASOCIACION URUGUAYA DE VOLANTES	04/03/2021	163
521693	08/09/2022	(figurativa)	18, 25 y 28	ADIDAS INTERNATIONAL MARKETING B.V.	29/03/2021	34
521694	08/09/2022	SUPERESCARABAJOS	41	ASOCIACION URUGUAYA DE VOLANTES	09/03/2021	163
521695	08/09/2022	PENALTY	9	ALFREDO ESTEBAN WARSZAWSKI	08/03/2021	34
521696	08/09/2022	REVISTA JURIDICA LA LEY URUGUAY	16 (S/D)	LA LEY SOCIEDAD ANONIMA EDITORA E IMPRESORA	17/05/2021	34
521697	08/09/2022	LA LEY ONLINE (mixta)	35, 38, 41 y 45	LA LEY SOCIEDAD ANONIMA EDITORA E IMPRESORA	13/04/2021	34

N° Exp	Resolución	Denominación	Clases	Titular	Vigencia	Ag.
521700	08/09/2022	RADIO ACTIVA 89.9 (mixta)	38 (S/D)	TAUROZZI NEGRI, CARLOS DIEGO	28/02/2021	189
521702	08/09/2022	BROCOS	35 y 39	Brocos S.A.	23/03/2021	194
521705	08/09/2022	SOBRECITOS	31 (S/D)	Mars, Incorporated	17/08/2021	245
521706	08/09/2022	RECOMENDADO POR EXPERTOS CRIADORES	31	Mars, Incorporated	30/05/2021	245
521707	08/09/2022	SNICKERS (mixta)	30 (S/D)	Mars, Incorporated	27/05/2021	245
521708	08/09/2022	(figurativa)	31 (S/D)	Mars, Incorporated	06/05/2021	245
521709	08/09/2022	KITEKAT (mixta)	31 (S/D)	Mars, Incorporated	17/08/2021	245
521710	08/09/2022	SOBRE	31 (S/D)	Mars, Incorporated	17/08/2021	245
521711	09/09/2022	POUCH	31 (S/D)	Mars, Incorporated	17/08/2021	245
521713	09/09/2022	MALTESERS	30	Mars, Incorporated	27/05/2021	245
521714	09/09/2022	CTS WELDING ALLOYS (mixta)	9 y 35	SOLDADURAS DEL ATLANTICO S.R.L.	03/08/2021	94
521715	09/09/2022	INTEL INSIDE	9	INTEL CORPORATION	21/06/2021	245
521716	09/09/2022	BP ALPHA	36	BP Alpha S.A.	28/03/2021	218
521721	09/09/2022	BODART B (mixta)	9 (S/D)	NOBLELOOK S.A.	04/03/2021	201
521722	09/09/2022	(figurativa)	10	MEDELA HOLDING AG	14/03/2021	201
521724	09/09/2022	(figurativa)	5	MEDELA HOLDING AG	14/03/2021	201
521727	09/09/2022	LOCKOUT	25 (S/D) y 26 (S/D)	W. L. GORE & ASSOCIATES, INC.	01/03/2021	245
521728	09/09/2022	LOCKOUT (mixta)	25 (S/D) y 26 (S/D)	W. L. GORE & ASSOCIATES, INC.	01/03/2021	245
521733	09/09/2022	XOMOX	6 y 20	XOMOX PFT CORP.	04/03/2021	144
521734	09/09/2022	TUFLIN	6	XOMOX PFT CORP.	04/03/2021	144
521735	09/09/2022	TUFLINE	6	XOMOX PFT CORP.	04/03/2021	144
521738	09/09/2022	TRANSPORTES VAZQUEZ S.R.L. (mixta)	35 y 39 (S/D)	Transportes Vazquez S.R.L.	28/02/2021	101
521750	09/09/2022	NEOMED TECNOLOGIA MEDICA (mixta)	10	NEOMED S.A.S.	28/03/2021	194
521753	09/09/2022	PUNTA CALA	41 y 43	LYMO S.A.	03/03/2021	94
521754	09/09/2022	MERCADO LIBRE.COM (mixta)	35, 36, 38, 42 y 45	MercadoLibre Inc.	09/03/2021	94
521755	09/09/2022	PROGEFFIK	5	LABORATORIOS EFFIK, S.A.	19/03/2021	94

N° Exp	Resolución	Denominación	Clases	Titular	Vigencia	Ag.
521756	09/09/2022	AÑEJADO POR ENCIMA DE LAS NUBES	33	RUM CREATION & PRODUCTS INC.	03/03/2021	212
521757	09/09/2022	VIAJE CON GUSTO	39 (S/D)	VANGUARD TRADEMARK HOLDINGS USA LLC	29/03/2021	194
521760	09/09/2022	DON ANSELMO	29	ROYBAL MARCHISIO, JORGE SEBASTIAN	25/03/2021	194
521765	09/09/2022	MAR BRAVA	29	NEGOCIOS INDUSTRIALES REAL NIRSA S.A.	09/03/2021	212
521770	09/09/2022	MAR DEL NORTE	29	NEGOCIOS INDUSTRIALES REAL NIRSA S.A.	09/03/2021	212
521771	09/09/2022	TOPO GIGIO (mixta)	9 (S/D), 16 (S/D) y 28 (S/D)	ALESSANDRO ROSSI	11/09/2020	34
521812	07/09/2022	IDEAL	19 (S/D)	COMPAÑIA NACIONAL DE CEMENTOS S.A.	22/03/2021	144
521842	06/09/2022	AUSTIN	13	AUSTIN POWDER COMPANY (UNA CORPORACION DE OHIO)	23/03/2021	201
521937	29/09/2022	DIFFCORE	5 (S/D)	SMITHKLINE BEECHAM (CORK) LIMITED	25/04/2021	216
521951	29/09/2022	DIRECTV HD (mixta)	9, 38 y 41	Vrio Corp.	22/06/2021	218
521954	29/09/2022	DIRECTV+HDDVR (mixta)	9, 38 y 41	Vrio Corp.	08/06/2021	218
522025	29/09/2022	PANEX CITRUS (mixta)	21 (S/D)	SEB DO BRASIL PRODUTOS DOMESTICOS LTDA.	16/05/2021	34
522080	26/09/2022	AKT (mixta)	12	COLOMBIANA DE COMERCIO S.A.; SIGLAS CORBETA S.A. y Y/O ALKOSTO S.A.	09/03/2021	212
522105	29/09/2022	(figurativa)	41, 44 y 45	CRAME IAMPP	09/03/2021	101
522218	06/09/2022	CALA DI VOLPE	43	BONPOINT S.A.	12/02/2021	189
522227	06/09/2022	SEDAXTRA	1 (S/D) y 5 (S/D)	SYNGENTA PARTICIPATIONS AG	04/04/2021	194
522280	06/09/2022	CRUCERO PROPIEDADES	36 (S/D)	Ana Lorena Miraballes Kukurian	18/03/2021	
522284	29/09/2022	COSTAN (mixta)	11 (S/D)	EPTA S.P.A.	15/03/2021	212
522359	06/09/2022	NEOGUM	30	ARCOR S.A.I.C.	19/05/2021	154

N° Exp	Resolución	Denominación	Clases	Titular	Vigencia	Ag.
522413	06/09/2022	NATURAPIS	3 y 30	Edison Ariel Fontana Ribolla	29/03/2021	
522423	06/09/2022	INFINOX	10 (S/D)	DePuy Synthes, Inc.	02/05/2021	194
522434	30/09/2022	LASSO	10 (S/D)	Biosense Webster, Inc.	16/04/2021	194
522436	30/09/2022	QWIK CABLE	10 (S/D)	Biosense Webster, Inc.	16/04/2021	194
522474	30/09/2022	MIRADOR	5 (S/D)	ADAMA Celsius B.V.	21/03/2021	144
522504	30/09/2022	INTENSIVE THERAPY	3 (S/D)	Wella International Operations Switzerland Sàrl	08/04/2021	201
522515	30/09/2022	POP SECRET	31	SNYDER'S- LANCE, INC.	23/03/2021	136
522628	06/09/2022	SODA EL ALJIBE (mixta)	32 (S/D)	ALFONSO MUNCHS, CLAUDIO DAYAN	17/06/2021	189
522640	06/09/2022	POSTRE CHAJA DE PAYSANDU EL DE LA MEDALLITA CON DURAZNO (mixta)	30 (S/D)	CONFITERIA LAS FAMILIAS S.A.	05/04/2021	194
522642	06/09/2022	POSTRE CHAJA DE PAYSANDU EL DE LA MEDALLITA (mixta)	30 (S/D)	CONFITERIA LAS FAMILIAS S.A.	05/04/2021	194
522652	06/09/2022	EL BARRIL	43	Enrique Daniel Coimbra Silva	01/04/2021	104
522718	06/09/2022	CIGUENA (mixta)	3 (S/D)	ATLANTIS S.A.	25/02/2021	212
522738	26/09/2022	PHI PHI TOYS (mixta)	28 (S/D)	DIEGO ALFREDO VARELA ROSSI y GUSTAVO DANIEL CURUTCHAGUE CARRIQUIRY	25/09/2021	144
522773	26/09/2022	NISAPLIN	1 (S/D)	DANISCO A/S	12/06/2021	165
522775	26/09/2022	KEVLAR	1 (S/D), 9 (S/D), 22 (S/D), 23 (S/D), 24 (S/D) y 25 (S/D)	DuPont Safety & Construction, Inc.	24/06/2021	165
522786	06/09/2022	OPERA	29	BAGLEY ARGENTINA S.A.	12/04/2021	154
522885	06/09/2022	HELLIGE	2	NUÑEZ, ALEJANDRO y NUÑEZ, EDUARDO	08/04/2021	189
522895	07/09/2022	SALINAS PANADERIA, CONFITERIA Y FABRICA DE PASTAS (mixta)	35 (S/D)	PITA HNOS LTDA y SUCESORES DE HORTENCIA GRANDAL SRL	20/12/2020	
522899	07/09/2022	SUPERMERCADO SALINAS AREA	35 (S/D)	PITA HNOS LTDA y SUCESORES	04/01/2021	

N° Exp	Resolución	Denominación	Clases	Titular	Vigencia	Ag.
		COMERCIAL (mixta)		HORTENCIA GRANDAL SRL		
522949	07/09/2022	TOKE	33 (S/D)	PADETEX S.A.	07/04/2021	219
522962	07/09/2022	POULVAC	5	ZOETIS SCHWEIZ GmbH	24/05/2021	194
522963	26/09/2022	CHALLENGER	12	COOPERATIVA BANCARIA	01/10/2021	165
522964	26/09/2022	LOUIS XIII	3	AVEL (SOCIÉTÉ PAR ACTIONS SIMPLIFIÉE)	26/07/2021	144
523017	26/09/2022	MATCH	5 (S/D)	SYNGENTA PARTICIPATIONS AG	27/05/2021	194
523019	07/09/2022	FOCETRIA	5 (S/D)	Seqirus UK Limited	25/05/2021	194
523026	26/09/2022	BATH & BODY WORKS	3 (S/D), 4, 5 y 35	BATH & BODY WORKS BRAND MANAGEMENT, INC.	29/06/2021	144
523089	07/09/2022	TAMPICO (mixta)	32	TAMPICO BEVERAGES, INC	16/05/2021	194
523097	30/09/2022	VOGUE PLATINE	34 (S/D)	American-Cigarette Company (Overseas) Limited	06/05/2021	194
523100	30/09/2022	INTRIGANTE	34 (S/D)	American-Cigarette Company (Overseas) Limited	20/05/2021	194
523102	30/09/2022	VOGUE FRISSON	34 (S/D)	American-Cigarette Company (Overseas) Limited	21/09/2021	194
523147	07/09/2022	(figurativa)	5 (S/D)	MERIAL	13/04/2021	245
523166	26/09/2022	TAU CERAMICA (mixta)	19 (S/D)	RIDDER CORPORATE, S.L.	09/05/2021	94
523167	07/09/2022	BIOVUE	10 (S/D)	Crimson International Assets LLC	28/04/2021	194
523171	26/09/2022	AMAZON	2 (S/D), 5 (S/D), 6 (S/D), 8 (S/D), 9 (S/D), 10 (S/D), 11 (S/D), 13 (S/D), 15 (S/D), 18 (S/D), 19 (S/D), 20 (S/D), 23 (S/D), 24 (S/D), 26 (S/D), 27 (S/D), 28 (S/D), 29 (S/D), 31 (S/D), 33 (S/D), 34 (S/D), 35 (S/D), 36	Amazon Technologies, Inc.	19/04/2021	194

N° Exp	Resolución	Denominación	Clases	Titular	Vigencia	Ag.
			(S/D), 37 (S/D), 38 (S/D), 39 (S/D), 40 (S/D), 41 (S/D), 42 (S/D), 43 (S/D), 44 (S/D) y 45 (S/D)			
523192	26/09/2022	KODAK (mixta)	1 (S/D)	KODAK AMERICAS LTD.	21/08/2021	165
523193	26/09/2022	TRI-X	1 (S/D) y 9 (S/D)	KODAK AMERICAS LTD.	21/08/2021	165
523198	26/09/2022	KODAK (mixta)	1 (S/D) y 9 (S/D)	KODAK AMERICAS LTD.	21/08/2021	165
523259	31/08/2022	NEOPROS	5	PHARMOS S.A.	30/05/2021	144
523261	31/08/2022	LA ABUNDANCIA	43	SILCOM S.A.	27/06/2021	144
523262	26/09/2022	ADINET (mixta)	38 y 41	ADMINISTRACION NACIONAL DE TELECOMUNICACIONES (ANTEL)	22/06/2021	144
523263	26/09/2022	ENCUENTRA (mixta)	38	ADMINISTRACION NACIONAL DE TELECOMUNICACIONES (ANTEL)	06/05/2021	144
523265	31/08/2022	DATIZIC	5 (S/D)	ZODIAC INTERNATIONAL CORPORATION	27/06/2021	245
523266	31/08/2022	IFERZIC	5 (S/D)	ZODIAC INTERNATIONAL CORPORATION	27/06/2021	245
523267	31/08/2022	AMEDRUGS (mixta)	42	ZODIAC INTERNATIONAL CORPORATION	15/07/2021	245
523269	31/08/2022	ILCO	6 (S/D)	KABA ILCO CORP.	03/05/2021	144
523272	31/08/2022	INDRA	3	ULRIC DE VARENS	16/07/2021	144
523287	30/09/2022	BENJAMIN	33	DANTE IRURTIA S.A.	18/04/2021	219
523288	31/08/2022	FIRESTONE	1 (S/D), 17 (S/D) y 19 (S/D)	BRIDGESTONE LICENSING SERVICES, INC.	29/09/2021	245
523291	31/08/2022	(figurativa)	3 (S/D), 11 (S/D), 17 (S/D) y 22 (S/D)	MINITUBISHI CORPORATION	26/04/2021	201
523292	31/08/2022	(figurativa)	17 (S/D)	MINITUBISHI CORPORATION	26/04/2021	201
523293	31/08/2022	(figurativa)	11 (S/D) y 17 (S/D)	MINITUBISHI CORPORATION	26/04/2021	201
523294	31/08/2022	(figurativa)	4 (S/D)	MINITUBISHI CORPORATION	26/04/2021	201
523299	26/09/2022	LONDON INSTITUTE (mixta)	41	MARIA DEL ROSARIO ESTRADA	18/04/2021	245

N° Exp	Resolución	Denominación	Clases	Titular	Vigencia	Ag.
				BARREIRO; MARIA MAGDALENA EGOZCUE ALGORTA y MARÍA FERNANDA EGOZCUE ALGORTA		
523300	26/09/2022	F FRAM (mixta)	7 (S/D) y 12 (S/D)	FRAM Group IP LLC	25/02/2021	144
523301	31/08/2022	NANOCOMM (mixta)	9 (S/D)	NANOCOMM S.A.	28/04/2021	144
523302	31/08/2022	PUMA	32 (S/D) y 33 (S/D)	JULIO FRANCISCO GHIRARDI LOGULLO	19/04/2021	144
523305	31/08/2022	FUCEREP COOPERATIVA DE AHORRO Y CREDITO (mixta)	36 (S/D)	Cooperativa de Ahorro y Crédito Fucerep	19/04/2021	101
523308	31/08/2022	HERING (mixta)	16 (S/D), 18 (S/D), 20 (S/D), 21 (S/D), 22 (S/D), 23 (S/D), 24 (S/D), 25 (S/D) y 26 (S/D)	Cia. Hering	18/10/2020	212
523310	07/09/2022	QUIEN QUIERE SER MILLONARIO?	9 (S/D), 16 (S/D), 25 (S/D), 28 (S/D) y 41 (S/D)	Sony Pictures Television UK Rights Limited	24/05/2021	194
523311	31/08/2022	OSMOCOTE	1 (S/D)	Everris International B.V.	03/06/2021	245
523314	31/08/2022	SKYN	10 (S/D)	LifeStyles Healthcare Pte Ltd.	08/06/2021	216
523316	31/08/2022	DELOITTE & TOUCHE (mixta)	9, 35, 36, 42, 43, 44 y 45	DELOITTE TOUCHE TOHMATSU	06/09/2021	245
523318	31/08/2022	SKYN	10 (S/D)	LifeStyles Healthcare Pte Ltd.	08/06/2021	216
523323	31/08/2022	SALENTEIN	33	SALENTEIN ARGENTINA B.V.	19/04/2021	34
523325	31/08/2022	SALENTEIN PRIMUS	33	SALENTEIN ARGENTINA B.V.	19/04/2021	34
523326	31/08/2022	MCDONALD'S MCFEAST	30 (S/D)	McDonald's Corporation	24/05/2021	186
523332	31/08/2022	DR. BERNY	33	MARZUREL S.A.	20/07/2021	241
523337	31/08/2022	CAROLINA HERRERA	3 (S/D) y 14 (S/D)	Carolina Herrera Ltd.	28/05/2021	245
523343	31/08/2022	CERRO CHAPEU	32 (S/D) y 33 (S/D)	ARROYOS AZULES S.A.	26/04/2021	201
523347	31/08/2022	SALVADITAS	30	BAGLEY ARGENTINA S.A.	20/04/2021	154
523350	31/08/2022	SICILY BY DOLCE & GABBANA	3	DOLCE & GABBANA TRADEMARKS S.R.L.	09/05/2021	144

N° Exp	Resolución	Denominación	Clases	Titular	Vigencia	Ag.
523356	31/08/2022	FRENCHITAS	30	PEPSICO DE ARGENTINA S.R.L.	18/04/2021	201
523367	31/08/2022	FRANKE (mixta)	11 (S/D)	Franke Technology and Trademark Ltd	12/06/2021	179
523368	31/08/2022	FREESTYLE	1 (S/D), 5 (S/D) y 10 (S/D)	Abbott Diabetes Care Inc.	18/10/2021	136
523369	31/08/2022	CANARIAS CANARIAS CANARIAS CANARIAS CANARIAS CANARIAS (mixta)	30	CANARIAS S.A.	04/10/2021	94
523370	31/08/2022	ACROCEL (mixta)	25	ENCATEX S.A.	26/09/2021	94
523375	31/08/2022	DISCOVER FREEDOM	18 (S/D), 25 (S/D) y 35 (S/D)	JanSport Apparel Corp.	26/05/2021	144
523377	31/08/2022	SOLE VERT	18 (S/D)	JANSPORT APPAREL CORP.	13/06/2021	144
523379	31/08/2022	BIOVENT	18 (S/D)	JANSPORT APPAREL CORP.	15/06/2021	144
523380	31/08/2022	SOLE PACK	18 (S/D)	JANSPORT APPAREL CORP.	15/06/2021	144
523382	31/08/2022	LIFE TECHNOLOGIES (mixta)	1, 2, 5, 9, 16, 37 y 42	LIFE TECHNOLOGIES CORPORATION	04/07/2021	144
523384	31/08/2022	SHISEIDO (mixta)	3	SHISEIDO COMPANY LIMITED	27/05/2021	201
523388	31/08/2022	(figurativa)	5 (S/D)	NOVARTIS AG	19/10/2021	201
523393	31/08/2022	ELOTEX	1 (S/D)	CELANESE SWITZERLAND AG	03/05/2021	245
523397	31/08/2022	AXION FIESTA	3	COLGATE-PALMOLIVE COMPANY	02/05/2021	201
523398	31/08/2022	FABULOSO FIESTA	3	COLGATE-PALMOLIVE COMPANY	02/05/2021	201
523399	01/09/2022	SUAVITEL FIESTA	3	COLGATE-PALMOLIVE COMPANY	02/05/2021	201
523400	01/09/2022	FABULOSO FRESCURA ALPINA	3 (S/D)	COLGATE-PALMOLIVE COMPANY	04/05/2021	201
523402	01/09/2022	RIVOLI (mixta)	30	FABRICA DE FIDEOS RIVOLI S.A.	26/07/2021	245
523406	01/09/2022	HAN	9 (S/D)	HARTING ELECTRIC GMBH & CO. KG	03/05/2021	34
523407	01/09/2022	ELENA MIRO (mixta)	24 y 25	MIROGLIO FASHION S.R.L.	08/05/2021	212
523408	01/09/2022	MOTIVI (mixta)	24 y 25	MIROGLIO FASHION S.R.L.	03/05/2021	212
523409	01/09/2022	NEURODOP	5	LABORATORIO LIBRA SOCIEDAD ANONIMA	25/04/2021	129
523410	01/09/2022	INDASEC	5 (S/D)	LABORATORIOS INDAS, S.A.	12/06/2021	212

N° Exp	Resolución	Denominación	Clases	Titular	Vigencia	Ag.
523411	01/09/2022	PAMIRAY	5	LABORATORIO LIBRA SOCIEDAD ANONIMA	28/04/2021	129
523412	01/09/2022	KIT DE LUCES XENON HID & LED (mixta)	11 (S/D)	SANSHINE S.A.	08/09/2021	189
523415	01/09/2022	MERCO MOTOR GROUP	12	DECELESTE S.A.	02/05/2021	189
523423	01/09/2022	VOGUE	35 y 41	Advance Magazine Publishers, Inc.	25/04/2021	136
523425	01/09/2022	TODOS POR URUGUAY (mixta)	41 y 43	TODOS POR URUGUAY	10/05/2021	154
523426	01/09/2022	GLAMOUR	41 (S/D)	Advance Magazine Publishers, Inc.	25/04/2021	136
523427	01/09/2022	GODET	21 (S/D), 29 (S/D) y 30 (S/D)	ARCOR S.A.I.C.	26/04/2021	154
523428	01/09/2022	GQ (mixta)	35 y 41	Advance Magazine Publishers, Inc.	25/04/2021	136
523429	01/09/2022	EL DORADO	3 (S/D), 5, 8 y 32	POLAKOF Y CIA. S.A.	06/10/2021	94
523430	01/09/2022	MAZARS	35 (S/D), 41 (S/D) y 45 (S/D)	MAZARS	30/05/2021	194
523434	01/09/2022	RENNER	2	RENNER SAYERLACK S.A.	08/05/2021	34
523435	01/09/2022	ATP (mixta)	11	LUIS ANGEL MORENO GARCIA	02/05/2021	219
523436	01/09/2022	GROWING AND PROTECTING YOUR WEALTH	36 (S/D)	THE PRUDENTIAL INSURANCE COMPANY OF AMERICA	12/09/2021	144
523437	01/09/2022	INCAFRENT	1, 2 y 17	PINTURAS INCA S.A.	28/06/2021	34
523438	01/09/2022	ELGOURMET.COM	38 (S/D) y 41 (S/D)	AMC NETWORKS ARGENTINA S.C.A.	23/08/2021	201
523439	01/09/2022	VOLUMAT AGILIA	10 (S/D)	FRESENIUS KABI AG.	02/06/2021	34
523440	01/09/2022	DE LAS INDIAS	30	NAFIREY S.A.	03/05/2021	219
523444	01/09/2022	(figurativa)	32	THE COCA-COLA COMPANY	03/06/2021	94
523445	01/09/2022	MEGA BUS	35	GIRALOR S.A.	22/10/2021	34
523447	01/09/2022	SPRITE (mixta)	32	THE COCA-COLA COMPANY	06/06/2021	94
523449	01/09/2022	RIVOLI (mixta)	30	FABRICA DE FIDEOS RIVOLI S.A.	26/07/2021	245
523450	01/09/2022	TENFIELDIGITAL	9 y 42	TENFIELD S.A.	25/04/2021	34
523452	01/09/2022	FIELDCARD	9, 36 y 42	TENFIELD S.A.	25/04/2021	34
523453	01/09/2022	EGEUS	12	RENAULT S.A.S.	05/05/2021	201
523456	01/09/2022	PHOTOFIELD	9 y 16	TENFIELD S.A.	25/04/2021	34

N° Exp	Resolución	Denominación	Clases	Titular	Vigencia	Ag.
523458	01/09/2022	EFSET	16 y 41	SIGNUM INTERNATIONAL AG	08/05/2021	201
523461	01/09/2022	TENFIELDCARD	36	TENFIELD S.A.	25/04/2021	34
523462	01/09/2022	TENFIELD	9 y 42	TENFIELD S.A.	25/04/2021	34
523478	01/09/2022	FUNSA 8	12 (S/D)	COOPERATIVA 7 DE SETIEMBRE-FUNSA COOP	03/05/2021	219
523479	01/09/2022	QUAKER SWEET CRUNCH	30 (S/D)	THE QUAKER OATS COMPANY	04/05/2021	201
523480	01/09/2022	SI QUIERES, PUEDES	32 (S/D)	STOKELY-VAN CAMP, INC.	16/05/2021	201
523481	01/09/2022	FERIA DE LA ALIMENTACIÓN	41	CAMARA NACIONAL DE LA ALIMENTACION	27/04/2021	163
523482	01/09/2022	FRITOLAY	29 (S/D) y 30 (S/D)	PEPSICO, INC.	31/05/2021	201
523484	01/09/2022	OFTALER NICOLICH	5 (S/D)	LABORATORIOS SAVAL S.A.	10/05/2021	201
523485	01/09/2022	EUVIRAX LS SAVAL LS SAVAL LS SAVAL LS SAVAL LS SAVAL EUVIRAX LS SAVAL (mixta)	5	LABORATORIOS SAVAL S.A.	05/09/2021	201
523486	02/09/2022	WELLA PROFESSIONALS (mixta)	3 (S/D), 41 (S/D) y 44 (S/D)	Wella International Operations Switzerland Sàrl	13/05/2021	201
523489	02/09/2022	ADECCO	35, 41 y 42	ADECCO GROUP AG	12/06/2021	201
523490	02/09/2022	DENTAL LATINA	35	DENTAL LATINA LTDA.	02/06/2021	201
523491	02/09/2022	BOM BRIL	3, 5 (S/D) y 21	BRIL COSMÉTICOS S/A	22/10/2021	144
523493	02/09/2022	RED DENTIS RED ODONTOLÓGICA DE MONTEVIDEO (mixta)	44 (S/D)	C.O.M. DE LA A.O.U.	11/06/2021	201
523494	02/09/2022	MUSEO VIVO DE LA ALIMENTACIÓN	41 (S/D)	CAMARA NACIONAL DE LA ALIMENTACION	22/08/2021	163
523495	02/09/2022	THERMOWATT (mixta)	9 (S/D)	THERMOWATT S.p.A.	25/04/2021	192
523502	02/09/2022	GREEN MARK	32 y 33	VLAKTOR TRADING LIMITED	13/06/2021	34
523505	02/09/2022	ALARIS	37 y 42	CAREFUSION 303, INC.	04/05/2021	34
523509	02/09/2022	ANGIOCATH	10 (S/D)	BECTON DICKINSON AND COMPANY	23/05/2021	34
523510	02/09/2022	CONGRESO LATINO AMERICANO DE VITICULTURA Y ENOLOGÍA (mixta)	41	ASOCIACIÓN DE ENÓLOGOS DE URUGUAY	27/04/2021	194

N° Exp	Resolución	Denominación	Clases	Titular	Vigencia	Ag.
523514	02/09/2022	(figurativa)	9 (S/D) y 28 (S/D)	SEGA CORPORATION	23/08/2021	218
523515	02/09/2022	IVECO	7 (S/D), 8 (S/D), 9 (S/D), 11 (S/D), 12 (S/D), 14 (S/D), 17 (S/D) y 22 (S/D)	IVECO S.P.A.	26/04/2021	34
523526	02/09/2022	GREY GOOSE	33 (S/D)	BACARDI & COMPANY LIMITED	03/08/2021	194
523534	30/09/2022	SISLEY	25	BENETTON GROUP S.R.L.	08/05/2021	245
523535	02/09/2022	MASA ROYAL	16 (S/D) y 28	MOSCA HNOS S.A.	04/05/2021	192
523537	02/09/2022	VILEBREQUIN (mixta)	25 (S/D)	T.R.B. INTERNATIONAL SA	25/04/2021	201
523538	02/09/2022	BARCELÓ	43 (S/D)	BARCELÓ CORPORACIÓN EMPRESARIAL, S.A.	02/05/2021	216
523539	02/09/2022	BT (mixta)	12	TOYOTA MATERIAL HANDLING EUROPE AB	19/10/2021	245
523542	02/09/2022	LIBERTY	12 (S/D)	FCA US LLC	10/05/2021	194
523543	02/09/2022	JEEP LIBERTY	12 (S/D)	FCA US LLC	30/05/2021	194
523548	02/09/2022	COLBERT	3 (S/D)	Cannon S.A.	23/05/2021	104
523549	02/09/2022	SAMET	6 y 12	María Agustina Larrosa	13/07/2021	194
523555	02/09/2022	THE GREAT WALL (mixta)	9 (S/D)	NINGBO GREAT WALL PRECISION INDUSTRIAL CO., LTD.	22/08/2021	34
523556	02/09/2022	ARROZ DOBLE GALLO ORO (mixta)	30	MOLINOS IP S.A.	21/10/2021	34
523557	02/09/2022	FRAGATA (mixta)	29 y 30	GRUPO ÁNGEL CAMACHO, S.L.	22/10/2021	34
523558	02/09/2022	SISLEY	3 (S/D), 8 (S/D), 22 (S/D) y 26 (S/D)	C.F.E.B. SISLEY	23/10/2021	144
523559	02/09/2022	CONTI CONTI CONTI (mixta)	32 (S/D)	CASA DI CONTI LTDA.	14/09/2021	144
523562	02/09/2022	HEPACOAT	5 (S/D)	Cardinal Health 529, LLC	22/06/2021	194
523573	02/09/2022	CERTICAN	5 (S/D)	NOVARTIS AG	22/10/2021	201
523574	02/09/2022	KOSAK (mixta)	36	Roberto Kosak Satorski	02/01/2021	19
523578	02/09/2022	NUTRISON	5 (S/D)	N.V. NUTRICIA	22/10/2021	245
523579	02/09/2022	APERTURE	9	APPLE INC.	18/10/2021	245
523580	02/09/2022	YAKULT 40 (mixta)	29 y 32	KABUSHIKI KAISHA YAKULT	16/05/2021	194

N° Exp	Resolución	Denominación	Clases	Titular	Vigencia	Ag.
				HONSHA		
523581	02/09/2022	TAFFMAN-E (mixta)	32	KABUSHIKI KAISHA YAKULT HONSHA	27/05/2021	201
523582	02/09/2022	VALDORELLA (mixta)	33	BRUCK IMPORTAÇÃO, EXPORTAÇÃO E COMERCIO LTDA.	03/05/2021	192
523585	02/09/2022	URUGUAY NATURAL	1, 2, 3, 4, 5, 6, 7, 8, 9, 10, 11, 12, 13, 14, 15, 16, 17, 18, 19, 20, 21, 22, 23, 24, 25, 26, 27, 28, 29, 30, 31, 32, 33, 34, 35, 36, 37, 38, 39, 40, 41, 42, 43, 44 y 45	PRESIDENCIA DE LA REPUBLICA	09/05/2021	
523589	02/09/2022	LUNADINA	5	LABORATORIOS DISPERT S.A.	27/05/2021	201
523590	02/09/2022	BERTOLLI	29 (S/D) y 30 (S/D)	MIZKAN AMERICA, INC.	11/07/2021	192
523592	02/09/2022	LA SEGUNDA COOPERATIVA LIMITADA DE SEGUROS GENERALES	36	LA SEGUNDA COOPERATIVA LTDA. DE SEGUROS GENERALES	04/05/2021	192
523593	02/09/2022	BOCADITO (mixta)	30	BONAFIDE S.A.I.C.	21/10/2021	94
523596	30/09/2022	(figurativa)	36 y 44	THE BRITISH UNITED PROVIDENT ASSOCIATION LIMITED	29/04/2021	216
523598	30/09/2022	BUPA	36 y 44	THE BRITISH UNITED PROVIDENT ASSOCIATION LIMITED	20/07/2021	216
523603	02/09/2022	MARIOLA (mixta)	29	DA COLONIA ALIMENTOS NATURAIS LTDA.	26/10/2021	245
523605	05/09/2022	LA SERENISIMA SERECOL	5 y 29	MASTELLONE HNOS. S.A.	03/05/2021	245
523606	05/09/2022	ECO DE LOS ANDES (mixta)	29, 30, 32 y 33	ECO DE LOS ANDES S.A.	03/05/2021	144
523607	05/09/2022	ESPUMAPLAST	6 (S/D) y 19 (S/D)	BROMYROS S.A.	21/05/2021	201
523608	05/09/2022	ESPUMAPLAST	1 y 37	BROMYROS S.A.	24/05/2021	201
523611	05/09/2022	TENDENCIAS	16 (S/D)	EDICIONES URANO S.A	14/07/2021	34

N° Exp	Resolución	Denominación	Clases	Titular	Vigencia	Ag.
523613	05/09/2022	EL VELAZCO	33	BODEGAS SAN HUBERTO S.A.	03/05/2021	34
523627	05/09/2022	TENSIBONA	5	SZABO S.A.	27/05/2021	212
523629	05/09/2022	VIGOTONE	5	SZABO S.A.	12/06/2021	212
523630	05/09/2022	EVAN PICONE	18	PREMIER BRANDS IP L.L.C.	27/05/2021	245
523632	26/09/2022	RADISSON	35 (S/D) y 43 (S/D)	Radisson Hospitality Belgium BV/SRL	27/05/2021	136
523634	05/09/2022	FORD MODELS SUPERMODEL OF THE WORLD	41 (S/D)	Ford Models, Inc.	09/05/2021	136
523648	05/09/2022	TRIANGLE (mixta)	12	TRIANGLE TYRE CO., LTD.	01/10/2021	144
523649	05/09/2022	LIANA	12	SUZUKI MOTOR CORP.	22/06/2021	216
523650	26/09/2022	R REALTOR (mixta)	36 (S/D), 41 (S/D) y 42 (S/D)	NATIONAL ASSOCIATION OF REALTORS	30/05/2021	194
523652	05/09/2022	(figurativa)	1 (S/D), 5 (S/D), 9 (S/D) y 10 (S/D)	SYSMEX CORPORATION	06/06/2021	216
523653	05/09/2022	(figurativa)	6 (S/D) y 7 (S/D)	Sumitomo Heavy Industries, Ltd	02/06/2021	216
523655	05/09/2022	MAZDA (mixta)	7 (S/D)	MAZDA MOTOR CORPORATION	16/06/2021	216
523656	05/09/2022	THE POWERPUFF GIRLS (mixta)	14, 16, 21, 24, 25, 28, 29, 30, 32 y 35	THE CARTOON NETWORK , INC.	24/05/2021	216
523657	05/09/2022	LAS CHICAS SUPERPODEROSAS	41	THE CARTOON NETWORK, INC.	24/05/2021	216
523658	05/09/2022	WARNER BROS (mixta)	9 (S/D)	WARNER BROS. ENTERTAINMENT INC.	31/05/2021	216
523660	05/09/2022	.T...SYSTEMS. (mixta)	9 (S/D), 37 (S/D), 38 (S/D) y 42 (S/D)	DEUTSCHE TELEKOM AG	26/07/2021	245
523661	05/09/2022	GREEN CHEF	30	COOPAR S.A.	08/06/2021	245
523663	05/09/2022	GRADINA	29 (S/D)	SEARA ALIMENTOS LTDA.	12/05/2021	34
523664	05/09/2022	CAREFUSION	5 (S/D), 9 (S/D), 10 (S/D), 37 (S/D), 42 (S/D) y 44 (S/D)	CareFusion Corporation	06/05/2021	34
523665	05/09/2022	E- Z SET	10 (S/D)	BECTON DICKINSON AND COMPANY	23/05/2021	34
523667	05/09/2022	CHRISTIAN BRETON	3	Christian Breton	17/01/2021	101
523668	05/09/2022	CERNEVIT	5 (S/D)	Baxter International Inc.	12/06/2021	218

N° Exp	Resolución	Denominación	Clases	Titular	Vigencia	Ag.
523670	05/09/2022	PRIMENE	5 (S/D)	Baxter International Inc.	12/06/2021	218
523672	05/09/2022	ARTRALGIN	5	JUAN CARLOS RIPOLL NOVOA	24/05/2021	220
523673	26/09/2022	MENNO (mixta)	16	PROVEEDORES INDUSTRIALES S.A	04/10/2021	
523675	05/09/2022	BANCO AUXILIO (mixta)	37 y 39	AUTO MOTRIX S.A.	30/05/2021	194
523677	05/09/2022	CONDUCTORES FUNSA	9 (S/D)	NEOROL S.A.	04/05/2021	219
523683	05/09/2022	HUMALOG KWIKPEN	10 (S/D)	ELI LILLY AND COMPANY	30/05/2021	34
523684	05/09/2022	ARMAND BASI	3 (S/D)	ARMAND BASI, S.L.	03/05/2021	181
523687	05/09/2022	(figurativa)	5 (S/D)	AMGEN INC.	11/05/2021	34
523689	05/09/2022	CUMBERLAND	16 (S/D)	Proveedores Industriales S.A.	18/10/2021	
523690	05/09/2022	SAF- T- CATH	10 (S/D)	BECTON DICKINSON AND COMPANY	23/05/2021	34
523693	05/09/2022	LONAFLEX (mixta)	7 y 12	FRAS-LE S.A.	03/05/2021	181
523696	05/09/2022	FRAS-LE (mixta)	7 (S/D) y 12 (S/D)	FRAS-LE S.A.	22/10/2021	181
523698	06/09/2022	SCOTT LIMPIAMAX	16 (S/D)	KIMBERLY-CLARK WORLDWIDE, INC	31/05/2021	34
523705	06/09/2022	TANGO	28 (S/D)	ADIDAS INTERNATIONAL MARKETING B.V.	23/05/2021	34
523706	06/09/2022	ZIPLOC	21 (S/D)	S.C.JOHNSON & SON, INC.	22/10/2021	34
523710	06/09/2022	SUPER TRUCK	9	POMBO GONZALEZ, LUIS NORBERTO	15/06/2021	201
523716	06/09/2022	FEU VERT (mixta)	7 (S/D), 12 (S/D) y 35 (S/D)	FEU VERT	03/05/2021	181
523723	06/09/2022	POWERFRAME	9 (S/D)	CPS Technology Holdings LLC	05/08/2021	144
523724	06/09/2022	(figurativa)	25 (S/D)	JOCKEY INTERNATIONAL, INC.	05/07/2021	144
523725	06/09/2022	(figurativa)	25 (S/D)	JOCKEY INTERNATIONAL, INC.	05/07/2021	144
523727	06/09/2022	LAPHROAIG	33	Beam Suntory UK Limited	03/05/2021	194
523728	06/09/2022	BPFINANCE (mixta)	35 y 36	BPFINANCE SOCIEDAD ANONIMA	16/05/2021	194
523729	06/09/2022	ROB ROY	33 (S/D)	Morrison Bowmore Distillers Limited	23/05/2021	194
523733	06/09/2022	CARNIPURE	1 (S/D), 5 (S/D) y 29 (S/D)	LONZA AG (LONZA LTD.)	08/06/2021	218

N° Exp	Resolución	Denominación	Clases	Titular	Vigencia	Ag.
523742	26/09/2022	SUPERCAT	31	SAN FRANCISCO C.I.S.A.	03/05/2021	154
523744	07/09/2022	(figurativa)	5 y 16	CMPC TISSUE S.A.	04/08/2021	221
523745	07/09/2022	RANDON MAXIMUM	5	KÖNIG URUGUAY SOCIEDAD ANONIMA	10/05/2021	129
523747	07/09/2022	(figurativa)	5 y 16	CMPC TISSUE S.A.	04/08/2021	221
523748	07/09/2022	PULGAS LOCAS	28	HASBRO INTERNATIONAL, INC.	08/05/2021	212
523749	07/09/2022	EL GUACAMAYA	35	MONICA LIDELBA CACERES BADANI	23/05/2021	129
523750	07/09/2022	JAY-LOR	7	JAY-LOR INTERNATIONAL INC.	12/05/2021	129
523751	07/09/2022	(figurativa)	16	CMPC TISSUE S.A.	04/08/2021	221
523753	07/09/2022	FURBY	28	HASBRO, INC.	08/05/2021	212
523754	07/09/2022	(figurativa)	16	CMPC TISSUE S.A.	04/08/2021	221
523755	07/09/2022	(figurativa)	16	CMPC TISSUE S.A.	04/08/2021	221
523756	07/09/2022	(figurativa)	5 y 16	CMPC TISSUE S.A.	04/08/2021	221
523757	07/09/2022	ABARTH	7 (S/D), 8 (S/D), 9 (S/D), 11 (S/D), 12 (S/D), 14 (S/D), 17 (S/D) y 22 (S/D)	FIAT GROUP MARKETING & CORPORATE COMMUNICATION S.P.A.	23/05/2021	212
523759	07/09/2022	(figurativa)	5 y 16	CMPC TISSUE S.A.	04/08/2021	221
523760	07/09/2022	SANCHO PANZA	33	ROSES HNOS. S.R.L.	03/05/2021	201
523762	07/09/2022	CHLOE	3	CHLOE SAS	30/10/2021	144
523763	07/09/2022	TISU (mixta)	16	CMPC TISSUE S.A.	04/05/2021	221
523764	07/09/2022	COSTA URBANA	16, 35, 36, 37, 41, 42 y 43	Costa Urbana S.A.	31/10/2021	144
523765	07/09/2022	(figurativa)	5 y 16	CMPC TISSUE S.A.	04/08/2021	221
523769	07/09/2022	RHONEPARINA	5 (S/D)	SANOFI	07/07/2021	144
523770	07/09/2022	(figurativa)	16	CMPC TISSUE S.A.	04/08/2021	221
523771	07/09/2022	SWISS MEDICAL	36 y 44	SWISS MEDICAL S.A.	16/05/2021	94
523772	07/09/2022	(figurativa)	5 (S/D)	Sanofi-Aventis Deutschland GmbH	12/09/2021	165
523773	07/09/2022	SEPRASPRAY	5 y 10	GENZYME CORPORATION	10/08/2021	165

N° Exp	Resolución	Denominación	Clases	Titular	Vigencia	Ag.
523774	07/09/2022	(figurativa)	16	CMPC TISSUE S.A.	04/08/2021	221
523775	07/09/2022	SYNVISC ONE (mixta)	5 y 10	GENZYME CORPORATION	10/08/2021	165
523776	30/09/2022	SOLOSTAR	5 (S/D) y 10 (S/D)	SANOFI-AVENTIS DEUTSCHLAND GmbH	12/07/2021	165
523777	07/09/2022	FOX	12	VOLKSWAGEN DO BRASIL INDUSTRIA DE VEICULOS AUTOMOTORES LTDA.	02/05/2021	194
523778	07/09/2022	PLAYLIFE	18 (S/D) y 25 (S/D)	BENETTON GROUP S.r.l.	03/06/2021	245
523779	07/09/2022	SYNVISC-ONE	5 y 10	GENZYME CORPORATION	10/08/2021	165
523780	08/09/2022	(figurativa)	16	CMPC TISSUE S.A.	04/08/2021	221
523781	08/09/2022	ZONDA LIMITADA MECANICA ESPECIALIZADA (mixta)	37 (S/D)	RELMONT S.A.	04/05/2021	245
523782	08/09/2022	INSTITUTO UNIVERSITARIO ASOCIACION CRISTIANA DE JOVENES ALMA MENTE CUERPO (mixta)	16, 41, 42, 43, 44 y 45	ASOCIACION CRISTIANA DE JOVENES DE MONTEVIDEO	07/05/2021	201
523784	08/09/2022	(figurativa)	16	CMPC TISSUE S.A.	04/08/2021	221
523785	08/09/2022	OXICLEAN	5 (S/D)	Church & Dwight Co., Inc.	03/06/2021	34
523786	08/09/2022	SADIA LIGHT	29	BRF Singapore Foods PTE Limited	09/05/2021	94
523787	08/09/2022	BEBEX	5, 16 y 25	LA PAPELERA DEL PLATA S.A.	13/08/2021	221
523789	08/09/2022	POO-CHI	28	HASBRO, INC.	08/05/2021	212
523791	08/09/2022	BIRBO	31	NUTRIRE INDUSTRIA DE ALIMENTOS LTDA.	11/08/2021	212
523792	08/09/2022	MB MILTON BRADLEY	28	HASBRO INTERNATIONAL, INC.	16/08/2021	212
523793	08/09/2022	ALANTO	5 (S/D)	Bayer Intellectual Property GmbH	11/07/2021	221
523794	08/09/2022	TRANSFORMERS	28	HASBRO INTERNATIONAL, INC.	25/06/2021	212
523796	08/09/2022	NUTRIRE	31	NUTRIRE INDUSTRIA DE ALIMENTOS LTDA.	11/05/2021	212
523797	08/09/2022	CONNECT 4 FLIP	28	HASBRO INTERNATIONAL, INC.	07/06/2021	212
523799	08/09/2022	NUBEQA	5 (S/D) y 10 (S/D)	Bayer Intellectual Property GmbH	14/07/2021	221
523801	08/09/2022	BRAVO	12 (S/D)	PIAGGIO & C. S.p.A.	27/05/2021	212

N° Exp	Resolución	Denominación	Clases	Titular	Vigencia	Ag.
523802	08/09/2022	VICK VAPORUB (mixta)	5	THE PROCTER & GAMBLE COMPANY	30/05/2021	212
523805	08/09/2022	INTEL	16, 38 (S/D), 42 (S/D) y 44 (S/D)	INTEL CORPORATION	08/06/2021	245
523808	08/09/2022	FPPF (mixta)	1 y 4	CARLOS PFEIFF	13/06/2021	220
523809	08/09/2022	LUSOL	1 (S/D), 2 (S/D), 3 (S/D), 16 (S/D) y 27 (S/D)	PINTURAS INDUSTRIALES S.A.	23/05/2021	201
523810	08/09/2022	HANSAPLAST (mixta)	5 (S/D)	BEIERSDORF AG	23/05/2021	201
523811	08/09/2022	V-ROD	12 (S/D)	H-D U.S.A., LLC	24/05/2021	201
523812	08/09/2022	HARLEY-DAVIDSON	12 (S/D)	H-D U.S.A., LLC	27/05/2021	201
523813	08/09/2022	AXOR	6, 10, 11, 17, 20 y 21	HANSGROHE SE	24/05/2021	201
523814	08/09/2022	RUBITO (mixta)	17 y 19	APRAHAMIAN - KELEK S.A.	17/06/2021	220
523816	08/09/2022	ATARI	35 y 41	ATARI INTERACTIVE, INC.	05/05/2021	181
523819	08/09/2022	+AUTOS.COM.UY (mixta)	35 y 38	PERLAWAY S.A.	12/07/2021	144
523827	08/09/2022	ASOLO (mixta)	18, 22, 25 y 28	ASOLO S.R.L.	27/05/2021	194
523829	08/09/2022	T-SYSTEMS (mixta)	9 (S/D), 16 (S/D), 35 (S/D), 36 (S/D), 37 (S/D), 38 (S/D) y 42 (S/D)	DEUTSCHE TELEKOM AG	03/08/2021	245
523830	08/09/2022	CONDÉ NAST TRAVELER	35 y 41	Advance Magazine Publishers, Inc.	10/05/2021	136
523845	08/09/2022	SIERRA SILVER - ELABORADO DE AGAVE AZUL (mixta)	33 (S/D)	BORCO-MARKEN-IMPORT MATTHIESEN GMBH & CO. KG	29/06/2021	219
523847	08/09/2022	(figurativa)	39	Der Grüne Punkt - Duales System Deutschland GmbH	12/05/2021	219
523860	08/09/2022	CENTRO DE PINTURAS (mixta)	2 (S/D) y 37 (S/D)	PPG INDUSTRIAL DO BRASIL-TINTAS E VERNIZES-LTDA.	08/06/2021	144
523861	08/09/2022	HAWTHORN SUITES	43	U.S. FRANCHISE SYSTEMS, INC.	12/09/2021	144
523869	08/09/2022	COLANYL	2 (S/D)	CLARIANT PRODUKTE (DEUTSCHLAND) GmbH	12/06/2021	34

N° Exp	Resolución	Denominación	Clases	Titular	Vigencia	Ag.
523871	08/09/2022	ATTRALUX	11 (S/D)	Signify Holding B.V.	22/06/2021	34
523872	08/09/2022	SUNGLASS HUT	35 (S/D)	LUXOTTICA U.S. HOLDINGS CORP.	21/09/2021	194
523873	08/09/2022	METZELER	12	PIRELLI TYRE S.P.A.	27/05/2021	34
523875	08/09/2022	PZERO	12 (S/D)	PIRELLI TYRE S.P.A.	22/06/2021	192
523878	27/09/2022	SONORA BORINQUEN	41	DIEGO GOBERNA	19/10/2021	
523879	08/09/2022	RUSTY DUSTY	9 (S/D) y 14 (S/D)	NERMER SOCIEDAD ANÓNIMA	08/05/2021	189
523885	09/09/2022	STARA	7	STARA S/A INDÚSTRIA DE IMPLEMENTOS AGRÍCOLAS	26/10/2021	218
523886	09/09/2022	FARM FRITES (mixta)	29 (S/D)	FARM FRITES INTERNATIONAL B.V.	23/09/2021	216
523887	09/09/2022	CELLULAR CORNER (mixta)	35	NORMISUR S.A.	24/05/2021	216
523890	09/09/2022	UNICELL LA COMUNICACIÓN A SU SERVICIO (mixta)	38	Normisur S.A.	07/05/2021	216
523891	09/09/2022	UNICELL : MAS QUE ACCESORIOS. NECESARIOS.	38	Normisur S.A.	30/05/2021	216
523894	09/09/2022	TBWA	35 (S/D)	TBWA INTERNATIONAL B.V.	28/06/2021	156
523896	27/09/2022	MF59	5 (S/D)	Seqirus UK Limited	06/06/2021	194
523898	09/09/2022	VIGIA (mixta)	9 (S/D) y 12	COL-VEN S.A.	25/10/2021	94
523900	09/09/2022	OPTICA RUGLIO (mixta)	9, 35 (S/D) y 44 (S/D)	Homero Hugo Ruglio Meneguzzi	07/05/2021	101
523901	09/09/2022	IPESA INDUSTRIAS PLASTICAS POR EXTRUSION S.A. (mixta)	17	INDUSTRIAS PLASTICAS POR EXTRUSION S.A.	20/06/2021	94
523902	09/09/2022	IPESASILO (mixta)	17, 19 y 20	INDUSTRIAS PLASTICAS POR EXTRUSION S.A.	09/10/2021	94
523903	09/09/2022	IPESASILO (mixta)	16	INDUSTRIAS PLASTICAS POR EXTRUSION S.A.	26/10/2021	94
523908	09/09/2022	CONAFIN'AFISA (mixta)	36	CORPORACION NACIONAL PARA EL DESARROLLO	06/05/2021	245
523914	09/09/2022	EAU D`URUGUAY	3	EMILIO ORIBE PAULSON	20/05/2021	181
523915	09/09/2022	METACAM	5 (S/D)	BOEHRINGER INGELHEIM VETMEDICA GMBH	27/05/2021	201
523918	09/09/2022	BARNY`S	35 (S/D) y 43	HENDERSON & CIA. S.A.	27/05/2021	181

N° Exp	Resolución	Denominación	Clases	Titular	Vigencia	Ag.
523919	09/09/2022	GLISS	3	HENKEL AG & CO. KGAA	27/05/2021	201
523920	09/09/2022	MEDELA	5 (S/D)	MEDELA HOLDING AG	30/05/2021	201
523921	09/09/2022	QUATROMANOS	35	MARIA SILVINA ROCHA LABRIOLA	23/08/2021	201
523922	09/09/2022	TRANSTEC	5 (S/D)	GRÜNENTHAL GMBH	30/05/2021	201
523923	09/09/2022	TACURÚ (mixta)	16, 35 y 41	SOCIEDAD SAN FRANCISCO DE SALES	10/05/2021	19
523924	09/09/2022	LA PIDO	30	CAKE´S S.R.L.	30/05/2021	163
523928	09/09/2022	LIMOL BLACK COLA (mixta)	32	PABEWIL S.A.	11/10/2021	189
523929	09/09/2022	LIMOL (mixta)	32 (S/D) y 33 (S/D)	PABEWIL S.A.	28/10/2021	189
523931	09/09/2022	ALEXIA (mixta)	4 (S/D)	Shell Brands International AG	05/07/2021	136
523932	09/09/2022	SUN (mixta)	9	Oracle America, Inc.	12/06/2021	192
523933	09/09/2022	AIR BAG	9 (S/D)	PRYSMIAN S.p.A.	08/05/2021	192
523935	26/09/2022	FLEUR	9	OPTITECH S.R.L.	12/05/2021	179
523936	09/09/2022	SAMAN TACUARI	30	S.A. MOLINOS ARROCEROS NACIONALES	12/05/2021	192
523939	09/09/2022	ALPA (mixta)	32 y 33	COOPERATIVA NACIONAL DE PRODUCTORES DE LECHE (CONAPROLE)	27/05/2021	194
523940	09/09/2022	CLAAS (mixta)	7, 11 y 12	CLAAS KGaA mbH	27/05/2021	192
523941	09/09/2022	ISISPHARMA	3 (S/D) y 5	ISIS PHARMA GmbH	30/05/2021	192
523942	09/09/2022	RUBORIL	3 y 5	ISIS PHARMA GmbH	31/05/2021	192
523943	09/09/2022	TEEN DERM	3 y 5	ISIS PHARMA GmbH	31/05/2021	192
523944	09/09/2022	UVEBLOCK	3 y 5	ISIS PHARMA GmbH	31/05/2021	192
523945	09/09/2022	LA FAVORITA	36	EUROCAM S.A.	31/05/2021	192
523946	09/09/2022	DON SATUR (mixta)	30	DON SATUR S.R.L.	09/05/2021	144
523956	09/09/2022	CAPH COLEGIO DE ADMINISTRADORES DE PROPIEDAD HORIZONTAL (mixta)	16, 35 (S/D), 41 y 42	Colegio de Administradores de Propiedad Horizontal	10/05/2021	101
523961	09/09/2022	AMERICAN DREAM (mixta)	12	MERCEDES VALDES STELLA	07/05/2021	34
523965	09/09/2022	CONFITERIA BANZAI (mixta)	35 (S/D) y 43 (S/D)	RAFIDEL S.A.	10/05/2021	101

N° Exp	Resolución	Denominación	Clases	Titular	Vigencia	Ag.
523971	09/09/2022	WWW.TELEDOCE.COM.UY	35, 38 y 41	SOCIEDAD TELEVISORA LARRANAGA S.A.	13/07/2021	241
523972	12/09/2022	TELEDOCE WWW.TELEDOCE.COM (mixta)	35, 38 y 41	SOCIEDAD TELEVISORA LARRANAGA S.A.	10/08/2021	241
523977	27/09/2022	VISTONY PODER QUE LUBRICA MAS (mixta)	1 y 4	VISTONY COMPAÑIA INDUSTRIAL DEL PERÚ S.A.C.	09/05/2021	189
523978	12/09/2022	BONIBON	30	ARCOR S.A.I.C.	10/05/2021	154
523983	12/09/2022	SWISSIRON (mixta)	5 (S/D)	Vifor (International) Inc.	07/06/2021	194
523984	30/09/2022	ECOPLAST	21	Andrea Da Fonseca	31/10/2021	
523986	12/09/2022	TECHNYLSTAR	1 (S/D), 17 (S/D), 25 (S/D) y 28 (S/D)	POLYTECHNYL	07/06/2021	194
523987	12/09/2022	VOGUE (mixta)	34 (S/D)	American-Cigarette Company (Overseas) Limited	07/06/2021	194
523988	12/09/2022	DAIRYCO	5 (S/D)	FRIGORÍFICO MODELO S.A.	12/06/2021	34
523989	12/09/2022	DAIRYCO	29 (S/D) y 30 (S/D)	FRIGORÍFICO MODELO S.A.	12/06/2021	34
523990	12/09/2022	ARLA (mixta)	1 (S/D), 5 (S/D), 29 (S/D), 30 (S/D), 31 (S/D) y 32 (S/D)	Arla Foods amba	25/05/2021	194
523991	12/09/2022	BUKO	29 (S/D)	Arla Foods amba	30/06/2021	194
523992	12/09/2022	DEXTER (mixta)	25 (S/D)	DEXTER SHOE COMPANY	10/05/2021	94
523994	12/09/2022	CETEBE	5 (S/D)	GlaxoSmithkline Consumer Healthcare (UK) IP Limited	07/06/2021	216
523995	12/09/2022	M&M PROPIEDADES (mixta)	36	PUIG MEDINA, ARTURO	13/05/2021	194
524002	12/09/2022	HONORA (mixta)	29 (S/D)	Compañía Nacional de Levaduras Levapan S.A.	26/07/2021	216
524003	12/09/2022	BIO-CHLOR	5 (S/D)	Church & Dwight Co., Inc.	08/06/2021	34
524005	12/09/2022	KÉRASTASE REFLECTION (mixta)	3 (S/D)	L'OREAL	10/08/2021	144
524007	12/09/2022	BIG PONY	3 (S/D)	THE POLO/LAUREN COMPANY, L.P.	14/07/2021	144
524008	12/09/2022	COLLAGENIST	3 (S/D)	L'OREAL	20/07/2021	144
524009	12/09/2022	ELVIVE REPARACION TOTAL 5	3 (S/D)	L'OREAL	15/07/2021	144
524010	12/09/2022	NUTRI HYALURON	3 (S/D)	L'OREAL	19/09/2021	144

N° Exp	Resolución	Denominación	Clases	Titular	Vigencia	Ag.
524011	26/09/2022	AQUA POWER	3 (S/D)	BIO THERM	26/10/2021	144
524012	12/09/2022	CODIGO JUVENTUD	3 (S/D)	L' OREAL	12/10/2021	144
524013	12/09/2022	ILLUMINATION	3	L'OREAL	25/10/2021	144
524015	12/09/2022	LIPIKAR	3 (S/D) y 5 (S/D)	LA ROCHE-POSAY LABORATOIRE DERMATOLOGIQUE	25/10/2021	144
524018	12/09/2022	LIBELLULE	21	IRLER S.A.	27/05/2021	245
524021	12/09/2022	LUO	3 (S/D)	L'OREAL	31/10/2021	144
524022	12/09/2022	REMIX	3 (S/D)	L'OREAL	19/10/2021	144
524023	12/09/2022	RETI.C	3 (S/D)	L'OREAL	22/10/2021	144
524024	12/09/2022	ROUGE FOREVER	3	L'OREAL	25/10/2021	144
524025	12/09/2022	SEROZINC	3 (S/D) y 5	LA ROCHE-POSAY LABORATOIRE DERMATOLOGIQUE	22/10/2021	144
524026	12/09/2022	TOLERIANE	3 (S/D)	LA ROCHE-POSAY LABORATOIRE DERMATOLOGIQUE	16/10/2021	144
524027	12/09/2022	URBAN DECAY COSMETICS (mixta)	3 (S/D)	L'OREAL	09/10/2021	144
524028	12/09/2022	XERAND	3 (S/D) y 5	LA ROCHE-POSAY LABORATOIRE DERMATOLOGIQUE	25/10/2021	144
524030	12/09/2022	WALTER (mixta)	7 (S/D), 8 (S/D) y 9 (S/D)	WALTER AG	01/06/2021	201
524032	12/09/2022	DR MANUEL A LLANO	5	LLANO, MANUEL ANTONIO	05/07/2021	189
524033	12/09/2022	VILLA SANTA	29 y 30	MARCELO RUIZ IRIGOYEN	24/05/2021	189
524034	12/09/2022	VERADO	12	PEREZ ASTEGGIANTE, ALVARO	23/05/2021	201
524037	12/09/2022	(figurativa)	39 (S/D)	JOINT STOCK COMPANY RUSSIAN RAILWAYS	26/11/2020	179
524039	12/09/2022	SALMOCALCIN	5	GRAMON BAGO DE URUGUAY S.A.	27/05/2021	212
524040	12/09/2022	(figurativa)	39 (S/D)	JOINT STOCK COMPANY RUSSIAN RAILWAYS	26/11/2020	179
524042	12/09/2022	ASTROS	34 (S/D)	GPS WORLDWIDE CORP.	04/08/2021	212
524043	12/09/2022	BELFAST	34 (S/D)	GPS WORLDWIDE CORP.	04/08/2021	212
524048	13/09/2022	LACOSTE (mixta)	9 (S/D)	SPORLOISIRS S.A.	21/08/2021	212

N° Exp	Resolución	Denominación	Clases	Titular	Vigencia	Ag.
524049	13/09/2022	CLUB CARPINTERO MASISA (mixta)	41 (S/D)	MASISA S.A.	08/08/2021	212
524053	13/09/2022	OFICENTRO (mixta)	36	OFICENTRO S.R.L.	21/08/2021	201
524054	13/09/2022	SEXY, LOVE & PINK	25	BRANDING CORPORATION	09/06/2021	201
524056	13/09/2022	INOA	3 (S/D)	L' OREAL	30/05/2021	144
524057	13/09/2022	HYDRA SHINE	3 (S/D)	L'OREAL	01/11/2021	144
524062	26/09/2022	AGUA FRESCA-ADOLFO DOMINGUEZ (mixta)	3 (S/D)	Adolfo Domínguez, S.A.	08/06/2021	144
524064	13/09/2022	VILMORIN (mixta)	31 (S/D)	VILMORIN-MIKADO	23/05/2021	144
524069	13/09/2022	ATOCEM	1 (S/D)	ARKEMA FRANCE	25/10/2021	144
524079	13/09/2022	BRANDILI	25	MALHARIA BRANDILI LTDA.	11/06/2021	234
524080	13/09/2022	IPLANET	9	Oracle America, Inc.	25/09/2021	192
524082	13/09/2022	SEPHORA (mixta)	3 (S/D), 25, 35 (S/D) y 44 (S/D)	SEPHORA	12/06/2021	192
524083	13/09/2022	MAUBOUSSIN	3 (S/D)	MAUBOUSSIN SAS	22/06/2021	192
524085	13/09/2022	SCHINDLER	7 (S/D), 9 (S/D) y 37 (S/D)	INVENTIO AG	22/06/2021	212
524086	13/09/2022	CONAPROLE VITAL + PRES CONTROL	5 y 29	COOPERATIVA NACIONAL DE PRODUCTORES DE LECHE (CONAPROLE)	30/06/2021	194
524087	13/09/2022	ALL BLACKS	25	New Zealand Rugby Union Incorporated	06/07/2021	192
524088	13/09/2022	ROYAL (mixta)	16 y 28	MOSCA HNOS. S.A.	06/09/2021	192
524089	13/09/2022	JONES & CIA. S.A.	35, 36, 37, 38, 39, 40, 41 y 42	JONES & CIA. S.A.	19/09/2021	192
524090	13/09/2022	CONAHORRO	36	COOPERATIVA NACIONAL DE PRODUCTORES DE LECHE (CONAPROLE)	21/09/2021	194
524092	13/09/2022	MCINTOSH	9 (S/D)	McIntosh Laboratory, Inc. (a Delaware Corporation)	21/09/2021	192
524093	13/09/2022	(figurativa)	7 (S/D)	Grundfos Holding A/S	26/10/2021	192
524095	13/09/2022	A-DERMA (mixta)	3 (S/D) y 5 (S/D)	PIERRE FABRE DERMO-COSMETIQUE	09/08/2021	192

N° Exp	Resolución	Denominación	Clases	Titular	Vigencia	Ag.
524096	13/09/2022	JAVLOR	5 (S/D)	PIERRE FABRE MEDICAMENT	22/10/2021	192
524098	13/09/2022	PIJAMA PARTY	20 y 22	NACROWN INTERNATIONAL S.A.	05/10/2021	212
524101	13/09/2022	PROGRAMA VOLVE A LA ESCUELA - RED NACIONAL DE COBRANZA - REDPAGOS (mixta)	35 y 41	NUMMI S.A.	23/09/2021	192
524104	13/09/2022	RAINBOW	18, 20 y 22	NACROWN INTERNATIONAL S.A.	09/08/2021	212
524107	13/09/2022	MODERN (mixta)	10 (S/D)	MARCELO GABRIEL BRENER FOGJIEL	27/05/2021	245
524108	27/09/2022	ENBREL	5	WYETH LLC	12/06/2021	194
524110	13/09/2022	FLUVAC INNOVATOR	5 (S/D)	Zoetis Services LLC	22/06/2021	194
524118	13/09/2022	SAPECA	30 (S/D)	GERMANI ALIMENTOS LTDA.	19/07/2021	34
524121	13/09/2022	ZYMIL	5 y 29	PARMALAT S.p.A.	12/06/2021	34
524123	13/09/2022	SUNBRELLA (mixta)	24	GLEN RAVEN, INC.	16/05/2021	194
524124	13/09/2022	WARNER'S (mixta)	25 (S/D)	WARNACO U.S. INC.	31/05/2021	194
524127	13/09/2022	AMINDUS (mixta)	29 y 30	SANTA HELENA INDÚSTRIA DE ALIMENTOS S/A	22/06/2021	34
524128	13/09/2022	SINCRONIUM	5 (S/D)	FERRER INTERNACIONAL, S.A.	10/11/2021	34
524130	13/09/2022	TRINOMIA	5 (S/D)	FERRER INTERNACIONAL, S.A.	10/11/2021	34
524137	13/09/2022	VENOFER	5 (S/D)	Vifor (International) Inc.	12/06/2021	194
524138	13/09/2022	BARRACA SANITARIA PAYSANDU	35	MOISES B. WULF S.R.L.	27/05/2021	129
524139	13/09/2022	POSTRE SELVA NEGRA ROMY	30 (S/D)	JOSE ROGER HIRSCHLE	30/05/2021	129
524141	13/09/2022	HYPERCRIT	5	BIOSIDUS S.A.	30/03/2021	201
524144	13/09/2022	PERKINELMER (mixta)	9 (S/D)	PerkinElmer, INC.	15/06/2021	194
524145	13/09/2022	(figurativa)	3	SHISEIDO COMPANY LIMITED	27/05/2021	201
524146	28/09/2022	KAUNAS	9 (S/D), 21 y 25	COUTO VAINER, GRACIELA	03/05/2021	189
524147	14/09/2022	ESEBE BY SILVIA BRAUNER (mixta)	3	BRAUNER LUKSENBURG, SILVIA	10/11/2021	189
524148	14/09/2022	PEGALMO	5 (S/D)	SYNGENTA PARTICIPATIONS AG	22/06/2021	194
524149	14/09/2022	LISTEGO	5 (S/D)	SYNGENTA PARTICIPATIONS AG	22/06/2021	194
524150	14/09/2022	MONO CONDUCIL	5	LABORATORIOS CASASCO S.A.I.C.	25/06/2021	201
524151	14/09/2022	AMSTEL	32 (S/D)	Amstel Brouwerij B.V.	22/06/2021	194

N° Exp	Resolución	Denominación	Clases	Titular	Vigencia	Ag.
524153	14/09/2022	EVRA (mixta)	5 (S/D)	Richter Gedeon Nyrt.	14/08/2021	194
524156	14/09/2022	ST. DALFOUR (mixta)	29 (S/D)	ST. DALFOUR ET CIE. S.A.S.	11/01/2021	94
524159	14/09/2022	OYSHO	3, 9, 14, 18, 21, 24, 25, 35, 42, 43, 44 y 45	INDUSTRIA DE DISEÑO TEXTIL S.A. (INDITEX S.A.)	24/05/2021	201
524160	14/09/2022	SARA	1 (S/D), 2 (S/D), 3 (S/D), 4 (S/D), 6 (S/D), 7 (S/D), 8 (S/D), 9 (S/D), 10 (S/D), 11 (S/D), 13 (S/D), 14 (S/D), 16 (S/D), 17 (S/D), 19 (S/D), 20 (S/D), 21 (S/D), 22 (S/D), 23 (S/D), 26 (S/D), 27 (S/D), 28 (S/D) y 34 (S/D)	INDUSTRIA DE DISEÑO TEXTIL S.A. (INDITEX S.A.)	31/05/2021	201
524161	14/09/2022	SARA	1 (S/D), 2 (S/D), 3 (S/D), 4 (S/D), 8 (S/D), 16 (S/D) y 27 (S/D)	INDUSTRIA DE DISEÑO TEXTIL S.A. (INDITEX S.A.)	31/05/2021	201
524162	14/09/2022	SARA	3 (S/D), 8 (S/D), 22 (S/D) y 26 (S/D)	INDUSTRIA DE DISEÑO TEXTIL S.A. (INDITEX S.A.)	31/05/2021	201
524163	14/09/2022	SARA	1 (S/D), 4 (S/D), 6 (S/D), 7 (S/D), 9 (S/D), 10 (S/D), 11 (S/D), 17 (S/D), 19 (S/D) y 22 (S/D)	INDUSTRIA DE DISEÑO TEXTIL S.A. (INDITEX S.A.)	31/05/2021	201
524164	14/09/2022	SARA	7 (S/D), 8 (S/D), 9 (S/D), 11 (S/D), 14 (S/D) y 17 (S/D)	INDUSTRIA DE DISEÑO TEXTIL S.A. (INDITEX S.A.)	31/05/2021	201

N° Exp	Resolución	Denominación	Clases	Titular	Vigencia	Ag.
524165	14/09/2022	SARA	2 (S/D), 3 (S/D), 6 (S/D), 7 (S/D), 8 (S/D), 16 (S/D), 17 (S/D), 18 (S/D), 20 (S/D), 21 (S/D), 22 (S/D), 23 (S/D), 24 (S/D), 25 (S/D) y 26 (S/D)	INDUSTRIA DE DISEÑO TEXTIL S.A. (INDITEX S.A.)	31/05/2021	201
524166	14/09/2022	SARA	1 (S/D), 7 (S/D), 9 (S/D), 16 (S/D) y 20 (S/D)	INDUSTRIA DE DISEÑO TEXTIL S.A. (INDITEX S.A.)	31/05/2021	201
524167	14/09/2022	SARA	3 (S/D), 7 (S/D), 8 (S/D), 13 (S/D), 21 (S/D) y 28 (S/D)	INDUSTRIA DE DISEÑO TEXTIL S.A. (INDITEX S.A.)	31/05/2021	201
524168	14/09/2022	SARA	9 (S/D), 15 y 16 (S/D)	INDUSTRIA DE DISEÑO TEXTIL S.A. (INDITEX S.A.)	31/05/2021	201
524169	14/09/2022	SARA	34 (S/D)	INDUSTRIA DE DISEÑO TEXTIL S.A. (INDITEX S.A.)	31/05/2021	201
524170	14/09/2022	SARA	28 (S/D)	INDUSTRIA DE DISEÑO TEXTIL S.A. (INDITEX S.A.)	31/05/2021	201
524172	14/09/2022	SOUTHERN SUN	31	HORTIFRUT S.A.	25/05/2021	245
524173	14/09/2022	BERRY COLLECTION	31	HORTIFRUT S.A.	25/05/2021	245
524174	14/09/2022	TARCEVA	5 (S/D)	OSI PHARMACEUTICALS, LLC.	09/11/2021	245
524175	14/09/2022	(figurativa)	32 (S/D)	COMPAGNIE GERVAIS DANONE	31/10/2021	245
524178	14/09/2022	HISPASAT (mixta)	3	HISPASAT, S.A.	25/10/2021	34
524181	14/09/2022	EDICIONES SM (mixta)	9, 16 y 41 (S/D)	FUNDACIÓN SANTA MARIA	15/06/2021	144
524183	14/09/2022	EL TORO	29 (S/D)	GRUPO YBARRA ALIMENTACIÓN, S.L.	11/07/2021	216
524186	14/09/2022	M.C.W. (mixta)	5	ADAMA Makhteshim Ltd.	31/05/2021	165
524189	14/09/2022	GRANJA LA CABAÑA	29 y 31	MIRNABEL S.A.	30/05/2021	212
524190	14/09/2022	INTELLICAD	9 (S/D)	IntelliCAD Technology Consortium	22/10/2021	136

N° Exp	Resolución	Denominación	Clases	Titular	Vigencia	Ag.
524192	14/09/2022	GASOLINA	33 (S/D)	PAN AMERICAN PROPERTIES CORPORATION	26/05/2021	212
524193	14/09/2022	AXE TWIST	3 (S/D)	Unilever Global IP Limited	01/07/2021	136
524194	14/09/2022	DENTOCAN (mixta)	3	NATURAL CAN LTDA. y EDUARDO VAZQUEZ CORREA	28/07/2021	179
524195	27/09/2022	BACTER 2000	5	EDUARDO VAZQUEZ	17/05/2021	179
524196	27/09/2022	OCEAN DREAM	35	DANIEL CORREA HUELMO	29/08/2021	179
524198	27/09/2022	MISSION PHARMACAL (mixta)	5 (S/D)	MISSION PHARMACAL COMPANY	24/05/2021	194
524202	14/09/2022	EDITORIAL NORMA (mixta)	41	CARVAJAL PROPIEDADES E INVERSIONES S.A.	27/05/2021	218
524203	14/09/2022	(figurativa)	25	Abercrombie & Fitch Europe Sagl	10/06/2021	218
524208	14/09/2022	MIU MIU (mixta)	35	PRADA S.A.	15/06/2021	212
524209	27/09/2022	VITRO	2	NUÑEZ, ALEJANDRO y NUÑEZ, EDUARDO	08/04/2021	189
524210	14/09/2022	MIDAS (mixta)	7, 9 y 11	AJ S.A. CALIDAD ANTE TODO	31/10/2021	156
524211	14/09/2022	ZEXEL (mixta)	7 (S/D), 11 (S/D) y 12 (S/D)	BOSCH CORPORATION	14/11/2021	156
524212	14/09/2022	LINDOR	30	Chocoladefabriken Lindt & Sprüngli AG	16/10/2021	179
524213	14/09/2022	LE CORDON BLEU	9 (S/D), 16 (S/D), 28 (S/D), 35 (S/D) y 43 (S/D)	LE CORDON BLEU INTERNATIONAL BV	16/10/2021	156
524215	14/09/2022	RENEW YOU	3 (S/D)	SPIRITUAL & PERSONAL GROWTH TRUST	03/06/2021	144
524216	14/09/2022	MONTAGNE JEUNESSE	3 (S/D)	SPIRITUAL & PERSONAL GROWTH TRUST	03/06/2021	144
524218	15/09/2022	TONKA (mixta)	16, 18, 21, 24, 25 y 28	HASBRO INC.	31/10/2021	212
524222	15/09/2022	MARQUESITA	29 (S/D), 30 (S/D) y 31 (S/D)	DAGOL S.A.	23/05/2021	245
524223	15/09/2022	EL PAIS UPSS! (mixta)	16, 38 y 41	EL PAIS S.A.	23/05/2021	245
524224	15/09/2022	PESCAMAR	29 (S/D)	MAOSOL S.A.	18/02/2021	245

N° Exp	Resolución	Denominación	Clases	Titular	Vigencia	Ag.
524225	15/09/2022	CINELATINO (mixta)	38	CINE LATINO, INC.	12/06/2021	245
524227	15/09/2022	EL PAIS UPSSS! (mixta)	16, 38 y 41	EL PAIS S.A.	20/05/2021	245
524228	15/09/2022	REEF BRAZIL CLASSIC	25	Trestles IP Holdings, LLC	08/06/2021	201
524229	15/09/2022	MOLINO GUIDO (mixta)	29, 30 y 31	CERCIDO, LOPEZ Y CIA. S.A.	07/07/2021	201
524231	15/09/2022	CARTON LLENO	16, 28, 36 y 41	EL PAIS S.A.	22/02/2021	245
524233	15/09/2022	ONDIL	29	ONDIL S.A.	27/09/2021	118
524234	15/09/2022	INFORMATIVO SARANDI	38 y 41	SARANDI COMUNICACIONES S.A.	21/09/2021	212
524236	15/09/2022	GRIFERIA VINDEK	11 (S/D)	DECOSOL S.A.	15/06/2021	201
524238	15/09/2022	TELEVISA	35	MOUNTRIGI MANAGEMENT GROUP, LTD.	16/05/2021	212
524241	15/09/2022	ABCHOME (mixta)	35	Macfisan SA.	29/09/2021	212
524243	15/09/2022	SPEEDAGRO	35	SPEEDAGRO S.R.L.	01/04/2021	34
524246	15/09/2022	TOSCANA DEL ESTE	36	AGROLAND S.A.	24/08/2021	216
524248	15/09/2022	BODEGA GARZÓN	35 y 43	AGROLAND S.A.	20/09/2021	216
524249	15/09/2022	DARISEC	5	URUFARMA S.A.	14/07/2021	34
524250	15/09/2022	BUPRION	5	EUROFARMA URUGUAY S.A.	24/05/2021	201
524251	15/09/2022	IBUPIRAC SUSPENSION (mixta)	5	URUFARMA S.A.	30/08/2021	34
524252	15/09/2022	KEMOTER	5	URUFARMA S.A.	26/08/2021	34
524253	15/09/2022	LA REVISTA DE TU SHOPPING MONTEVIDEO SHOPPING (mixta)	16 (S/D)	SHOPPING CENTERS (URUGUAY) S.A.	29/08/2021	34
524257	15/09/2022	MARY & JOE	25	José OTERO RAMOS	17/06/2021	28
524259	15/09/2022	PLATSUL - A	5	Soubeiran Chobet S.R.L.	27/05/2021	181
524260	15/09/2022	NECTAR	29 (S/D) y 30 (S/D)	ALÉ ESQUEFF, OMAR	05/07/2021	189
524263	15/09/2022	NITOYO	7	CYMACO S.A.	31/05/2021	154
524264	15/09/2022	SONYA (mixta)	3	ALOE VERA OF AMERICA INC.	21/06/2021	218
524265	15/09/2022	PLEXUS (mixta)	9 y 42	BIOCARE S.R.L.	01/06/2021	245
524267	15/09/2022	DJARUM (mixta)	34 (S/D)	P.T. DJARUM	16/05/2021	245
524268	15/09/2022	NERO	31 (S/D)	NEOVIA NUTRIÇÃO E SAÚDE ANIMAL LTDA.	12/11/2021	34
524269	15/09/2022	FLEVOMAX URUFARMA	5	URUFARMA S.A.	14/07/2021	34

N° Exp	Resolución	Denominación	Clases	Titular	Vigencia	Ag.
524270	15/09/2022	OVERLAND	12 (S/D)	FCA US LLC	15/06/2021	194
524271	15/09/2022	PENTASTAR	12 (S/D)	FCA US LLC	21/06/2021	194
524275	15/09/2022	MARCOLIN	9 (S/D)	MARCOLIN S.P.A.	02/07/2021	194
524278	15/09/2022	AUTOCAD	9	AUTODESK, INC.	27/05/2021	194
524279	15/09/2022	WWW.ARCOSMED.COM	5, 9, 10, 35, 37, 38, 42, 43, 44 y 45	NELSON ARCOS S.A.	11/06/2021	201
524281	15/09/2022	MARINA SANTA LUCIA (mixta)	41	NAITOL S.A.	16/05/2021	245
524283	15/09/2022	SUMA DE LETRAS (mixta)	16 (S/D)	EDITORIAL SUDAMERICANA URUGUAYA S.A.	01/11/2021	181
524291	15/09/2022	SCOTCH	9, 16 y 17	3M COMPANY	06/09/2021	144
524292	15/09/2022	HYPROX	1 (S/D), 3 (S/D) y 5 (S/D)	EVONIK OPERATIONS GmbH	25/09/2021	144
524294	15/09/2022	TEGA	5 (S/D)	3M COMPANY	23/08/2021	144
524299	16/09/2022	SIR EDWARD'S	33 (S/D)	BARDINET SAS	17/09/2021	217
524300	16/09/2022	ARRASA	5	BIOGÉNESIS BAGÓ S.A.	22/08/2021	34
524302	16/09/2022	FP FORESTIER POSE (mixta)	45	FORESTIER POSE S.A.	15/11/2021	144
524305	16/09/2022	CONVEROX	2	PREPAN S.A	13/08/2021	220
524306	16/09/2022	PISOACRIL	2	PREPAN S.A	05/09/2021	220
524307	16/09/2022	(figurativa)	7 (S/D), 9 (S/D), 11 (S/D) y 20 (S/D)	ARAG S.R.L.	08/06/2021	194
524308	16/09/2022	ARAG (mixta)	7 (S/D), 9 (S/D), 11 (S/D) y 20 (S/D)	ARAG S.R.L.	08/06/2021	194
524309	16/09/2022	EBIXA	5 (S/D)	MERZ PHARMA GMBH & CO. KGAA	25/06/2021	179
524315	16/09/2022	ECOM MR - QUÍMICOS AUTOMOTRICES - LA LÍNEA QUE TE DA MÁS!!! - WWW.E.COM.MX (mixta)	1	ECOLOGÍA EN COMBUSTIÓN, S.A. DE C.V.	23/06/2021	34
524316	16/09/2022	HIDRATOR SUMINISTROS INDUSTRIALES (mixta)	35 (S/D)	ATINO S.A.	01/06/2021	34
524317	16/09/2022	OPTIMOF	5 (S/D)	URUFARMA S.A.	12/09/2021	34
524322	16/09/2022	STRIFF	25	ANA BEATRIZ FAJARDO SANCHEZ	27/06/2021	34

N° Exp	Resolución	Denominación	Clases	Titular	Vigencia	Ag.
524324	16/09/2022	EAGLE CLAW	28 (S/D)	Wright & McGill Co.	23/08/2021	136
524325	16/09/2022	COLINEAL	20 y 35	COLINEAL CORPORATION CIA LTDA	17/11/2021	94
524326	16/09/2022	DACOLONIA ENIO MELO FREITAS (mixta)	30	DA COLONIA ALIMENTOS NATURAIS LTDA.	14/11/2021	245
524327	16/09/2022	LA NOCHE DE LA NOSTALGIA (mixta)	9 y 38	PABLO LECUEDER ATCHUGARRY	06/09/2021	34
524333	16/09/2022	CHIACAPS	3	URUFARMA S.A.	07/10/2021	34
524335	16/09/2022	OMINT (mixta)	35, 36, 42 y 44	OMINT S.A. de SERVICIOS	27/05/2021	34
524336	16/09/2022	SALVAGGIO (mixta)	3 (S/D)	HOUSE OF FULLER, S. de R.L. de C.V.	19/11/2021	34
524337	16/09/2022	SALVAGGIO BY HOF	3 (S/D)	HOUSE OF FULLER, S. DE R.L. DE C.V.	19/11/2021	34
524338	16/09/2022	MDV (mixta)	11 (S/D)	MIDEA GROUP CO. LTD.	15/11/2021	34
524340	16/09/2022	(figurativa)	36, 37, 38, 39, 40, 41, 42, 43, 44 y 45	SHOPPING CENTERS (URUGUAY) S.A.	20/05/2021	34
524344	16/09/2022	DERMANOVA MOVISUD S.A.	3 y 5	MOVISUD SOCIEDAD ANONIMA	24/05/2021	34
524347	16/09/2022	ERBITUX	5 (S/D)	ImClone LLC	15/11/2021	144
524350	16/09/2022	(figurativa)	36	BOLSA DE VALORES DE MONTEVIDEO	10/07/2021	201
524353	16/09/2022	LOGIRED (mixta)	39	PLATERAN S.A.	01/07/2021	201
524355	16/09/2022	SENSIENT	1 (S/D), 2 (S/D) y 30 (S/D)	SENSIENT TECHNOLOGIES CORPORATION	15/06/2021	194
524356	16/09/2022	F FREE SLIMS (mixta)	34 (S/D)	SOUZA CRUZ LTDA	24/06/2021	194
524357	16/09/2022	SERVIMEX (mixta)	39	SERVIMEX S.A.C.I.	24/05/2021	179
524359	16/09/2022	RECEPEDIA	16 (S/D), 38 (S/D) y 41 (S/D)	Conopco, Inc.	05/08/2021	136
524364	19/09/2022	ALUAR	6 (S/D) y 21 (S/D)	ALUAR ALUMINIO ARGENTINO S.A.I.C.	23/05/2021	245
524365	16/09/2022	JERZEES (mixta)	25	RUSSELL BRANDS, LLC	20/11/2021	245
524366	16/09/2022	5 DE ORO (mixta)	16, 28 y 41	BANCA DE CUBIERTA COLECTIVA DE QUINIELAS DE MONTEVIDEO	27/05/2021	245
524368	16/09/2022	OP	3 (S/D)	Iconix Latin America LLC	25/06/2021	194

N° Exp	Resolución	Denominación	Clases	Titular	Vigencia	Ag.
524369	16/09/2022	TASCO - ENDICOR	6	AUFERMANN, ROLF	28/03/2021	201
524370	16/09/2022	VELUX	9, 20, 22, 24 (S/D) y 37	VKR Holding A/S	19/11/2021	205
524371	16/09/2022	DOLCE & GABBANA	14 (S/D)	DOLCE & GABBANA TRADEMARKS S.R.L.	10/06/2021	144
524372	16/09/2022	D&G (mixta)	3 (S/D), 9 (S/D), 14 (S/D), 18 (S/D) y 25 (S/D)	DOLCE & GABBANA TRADEMARKS S.R.L.	09/06/2021	144
524374	19/09/2022	HUNTER (mixta)	18 (S/D) y 25 (S/D)	HUNTER BOOT LIMITED	25/05/2021	144
524375	16/09/2022	PRONTO! ESTÁ (mixta)	36	KEDAL S.A.	28/06/2021	194
524376	16/09/2022	TURBOGEN RUFFA (mixta)	7	MARIO PASCUAL RUFFA	21/06/2021	205
524380	16/09/2022	NORTHLAND AUSTRIA (mixta)	18, 20, 22 y 25	Sport & Fashion Management Pte Ltd	19/11/2021	144
524381	16/09/2022	FEMEXIN 28	5	URUFARMA S.A.	19/11/2021	34
524383	16/09/2022	NERVIDOCE	5	LABORATORIOS VIJOSA S.A. DE C.V.	14/11/2021	201
524386	19/09/2022	ETACRIL	5	URUFARMA S.A.	25/10/2021	34
524388	19/09/2022	CYCLONOR	5	LABORATORIOS VIJOSA S.A. DE C.V.	14/11/2021	201
524391	19/09/2022	VARIFLU URUFARMA	5	URUFARMA S.A.	03/10/2021	34
524395	19/09/2022	(figurativa)	5 (S/D), 9 (S/D), 10 (S/D), 37 (S/D), 42 (S/D) y 44 (S/D)	CAREFUSION CORPORATION	09/06/2021	34
524396	19/09/2022	FRIGORIFICO SAN JACINTO (mixta)	35	FRIGORIFICO SAN JACINTO NIREA S.A.	28/10/2021	118
524397	19/09/2022	MICRO-TEJIDO NUEVA TECNOLOGÍA +RENDIMIENTO +ABSORCIÓN +RESISTENCIA CON LA MÁXIMA SUAVIDAD ACOLCHONADITA (mixta)	16 (S/D)	KIMBERLY-CLARK WORLDWIDE, INC.	16/06/2021	34
524398	19/09/2022	PRONTO! TOTAL (mixta)	36	KEDAL S.A.	28/06/2021	194
524399	19/09/2022	(figurativa)	16 (S/D)	KIMBERLY-CLARK WORLDWIDE, INC.	02/06/2021	34
524408	19/09/2022	COLDWELL BANKER	16 y 36	Coldwell Banker LLC	19/11/2021	136

N° Exp	Resolución	Denominación	Clases	Titular	Vigencia	Ag.
		COMMERCIAL				
524411	19/09/2022	SOBREMESA	30	JOSE ALDAO S.A.	17/09/2021	186
524414	19/09/2022	MULTI SEÑAL DIGITAL (mixta)	16 y 38	MULTICANAL S.A.	29/06/2021	194
524415	19/09/2022	SHAKLEE	3 y 5 (S/D)	SHAKLEE CORPORATION	29/06/2021	194
524416	19/09/2022	MULTIMICRO	1 (S/D)	AGLUKON Spezialdünger GmbH & Co. KG	23/05/2021	194
524422	19/09/2022	PETROBRAS PODIUM (mixta)	4 (S/D)	PETROLEO BRASILEIRO S.A. - PETROBRAS	24/05/2021	94
524423	19/09/2022	PETROBRAX	1, 4, 39 y 40	PETROLEO BRASILEIRO S.A. - PETROBRAS	30/05/2021	94
524424	19/09/2022	BR AVIATION (mixta)	1, 4 y 39	PETROLEO BRASILEIRO S.A. - PETROBRAS	30/05/2021	94
524430	19/09/2022	CASCOLAR	16	HEXION INVESTMENTS INC.	12/11/2021	165
524433	19/09/2022	BOONE'S	33 (S/D)	E. & J. GALLO WINERY	25/10/2021	165
524434	19/09/2022	AMEN	35	AMÉN S.A.	31/05/2021	181
524435	19/09/2022	ERNEST & JULIO GALLO	33 (S/D)	E. & J. GALLO WINERY	20/11/2021	165
524441	19/09/2022	CORONA (mixta)	6 (S/D)	MUSTAD HOOF CARE SA	19/11/2021	34
524442	19/09/2022	MUSKAT VIOLET	33	CENTRO DE VITICULTORES DEL URUGUAY	30/05/2021	194
524444	19/09/2022	VISCONTI	30 (S/D)	PANDURATA ALIMENTOS LTDA.	23/05/2021	245
524445	19/09/2022	COLONIA ENCUENTRO MÁGICO (mixta)	36, 38, 39, 41 y 43	INTENDENCIA MUNICIPAL DE COLONIA y ASOCIACION TURISTICA DEPARTAMENTAL DE COLONIA	23/05/2021	144
524446	19/09/2022	METADATE	5 (S/D)	UCB PHARMA, S.A.	28/12/2020	34
524447	19/09/2022	CERTIFIEDFIRST	37 (S/D)	PPG INDUSTRIES OHIO, INC.	22/06/2021	144
524450	19/09/2022	CERAMICAS OUTLET (mixta)	35	HEY'DI URUGUAYA S.A.	24/05/2021	219
524455	19/09/2022	LGY	25	FLORENCIA MARIA AZQUETA SECCO	26/07/2021	34
524461	19/09/2022	G.PANIZ (mixta)	7	G.PANIZ INDUSTRIA DE EQUIPAMENTOS PARA ALIMENTAÇÃO LTDA.	24/05/2021	163

N° Exp	Resolución	Denominación	Clases	Titular	Vigencia	Ag.
524462	19/09/2022	GANT	25	GANT AB	14/11/2021	212
524463	19/09/2022	AERIE	3 (S/D), 14 (S/D), 18 (S/D), 25 (S/D) y 35 (S/D)	RETAIL ROYALTY COMPANY	30/06/2021	194
524464	20/09/2022	D&M	25 (S/D)	NICOLE TOBAL	23/05/2021	
524467	26/09/2022	PROTEO	9 y 42	MARIO DANIEL LAMAS	24/05/2021	21
524470	19/09/2022	MOVISTAR	9 y 38	TELEFONICA, S.A.	01/06/2021	201
524472	19/09/2022	DEESTONE	12	DEESTONE LIMITED	15/11/2021	94
524473	19/09/2022	HEAVY DUTY	3	LABORATORIOS CELSIUS S.A.	20/10/2021	144
524474	19/09/2022	CELICOX 2	5	LABORATORIOS CELSIUS S.A.	19/11/2021	144
524475	19/09/2022	FOSFOCOL FIDES (mixta)	5	LABORATORIOS CELSIUS S.A.	19/11/2021	144
524476	19/09/2022	PREVENESC	5	LABORATORIOS CELSIUS S.A.	20/11/2021	144
524477	19/09/2022	SUCRALIGHT	5	LABORATORIOS HAYMANN S.A.	17/09/2021	144
524478	20/09/2022	ROEMMERS VIMAX	5 (S/D)	Mega Labs S.A.	05/09/2021	144
524479	20/09/2022	VITASTRESS	5	Mega Labs S.A.	06/09/2021	144
524480	20/09/2022	AKESIS	5	Mega Labs S.A.	12/10/2021	144
524481	20/09/2022	GLIPEPTIL	5	Mega Labs S.A.	12/10/2021	144
524482	20/09/2022	XENEVIA	5	Mega Labs S.A.	12/10/2021	144
524483	20/09/2022	CETOPIC	3 (S/D) y 5 (S/D)	Mega Labs S.A.	16/10/2021	144
524484	20/09/2022	GLUCOVITAS	5	Mega Labs S.A.	23/10/2021	144
524485	20/09/2022	AIRPLEN	5	Mega Labs S.A.	25/10/2021	144
524486	20/09/2022	ALERGIBON	3 y 5	Mega Labs S.A.	25/10/2021	144
524487	20/09/2022	MICOFLAVIN	5	Mega Labs S.A.	25/10/2021	144
524488	20/09/2022	PROCICAR	3 (S/D) y 5 (S/D)	Mega Labs S.A.	25/10/2021	144
524489	20/09/2022	TENARON	5 (S/D)	Mega Labs S.A.	25/10/2021	144
524490	20/09/2022	UNICORT	3 y 5	Mega Labs S.A.	12/11/2021	144
524491	20/09/2022	BETAZOL	3 y 5	Mega Labs S.A.	14/11/2021	144
524492	20/09/2022	ROWE (mixta)	5 y 44	Mega Labs S.A.	22/11/2021	144
524493	20/09/2022	IODOMED	5	Megalabs Uruguay S.A	12/07/2021	144
524494	20/09/2022	DOLOREX	5 (S/D)	Megalabs Uruguay S.A.	24/07/2021	144

N° Exp	Resolución	Denominación	Clases	Titular	Vigencia	Ag.
524495	20/09/2022	CORBIS	5 (S/D)	Megalabs Uruguay S.A.	03/08/2021	144
524496	20/09/2022	ANAFIL	5 (S/D)	Megalabs Uruguay S.A.	06/08/2021	144
524497	20/09/2022	PIOMED	5	Megalabs Uruguay S.A.	19/09/2021	144
524498	20/09/2022	LANZO PACK	5 (S/D)	Megalabs Uruguay S.A.	17/10/2021	144
524500	20/09/2022	TOLTIN	5	Megalabs Uruguay S.A.	22/10/2021	144
524501	20/09/2022	DOLCOX PHARMOS	5 (S/D)	Megalabs Uruguay S.A.	26/10/2021	144
524502	20/09/2022	LIBERAN	5	Megalabs Uruguay S.A.	26/10/2021	144
524503	20/09/2022	TOPIRAX	5	Megalabs Uruguay S.A.	26/10/2021	144
524504	20/09/2022	CELEXA	5 (S/D)	Megalabs Uruguay S.A.	14/11/2021	144
524505	20/09/2022	MASIVOL	5	Megalabs Uruguay S.A.	15/11/2021	144
524506	20/09/2022	RISPA	5	Megalabs Uruguay S.A.	19/11/2021	144
524508	20/09/2022	AILEX	5	SPEFAR S.A.	10/08/2021	144
524509	20/09/2022	MULTISHOCK SPEFAR	5	SPEFAR S.A.	10/08/2021	144
524510	20/09/2022	SEREFAR SPEFAR	5	SPEFAR S.A.	10/08/2021	144
524511	20/09/2022	PELVIFAR	5	SPEFAR S.A.	30/08/2021	144
524512	20/09/2022	GONDRAND	12 (S/D)	GONDRAND HNOS S.A.	23/05/2021	34
524513	20/09/2022	DETENSIL SPEFAR	5	SPEFAR S.A.	23/10/2021	144
524514	20/09/2022	DIABEX SPEFAR	5 (S/D)	SPEFAR S.A.	23/10/2021	144
524515	20/09/2022	DOULAX	5 (S/D)	SPEFAR S.A.	23/10/2021	144
524516	20/09/2022	LUXOR	16 (S/D)	LUXOR WRITING INSTRUMENTS PVT. LIMITED	23/05/2021	34
524517	20/09/2022	MULSI-A	5	SPEFAR S.A.	23/10/2021	144
524518	20/09/2022	DEXALOR	5	SPEFAR S.A.	19/11/2021	144
524519	20/09/2022	ATUSIL	5	SPEFAR S.A.	21/11/2021	144
524521	21/09/2022	NEO SESAREN	5	Mega Labs S.A.	27/07/2021	144
524522	21/09/2022	ADEPRA	5 (S/D)	Mega Labs S.A.	03/08/2021	144
524524	21/09/2022	VI-MAX	5 (S/D)	Mega Labs S.A.	13/08/2021	144
524525	21/09/2022	SUDERMA	5	Mega Labs S.A.	16/08/2021	144
524526	21/09/2022	VIMAX ROEMMERS	5 (S/D)	Mega Labs S.A.	04/09/2021	144
524527	21/09/2022	VIMAX	5	Mega Labs S.A.	05/09/2021	144

N° Exp	Resolución	Denominación	Clases	Titular	Vigencia	Ag.
524528	21/09/2022	NISIROL	5	Mega Labs S.A.	18/09/2021	144
524529	21/09/2022	GRANJA MORO (mixta)	29 y 31	GRANJA TRES ARROYOS URUGUAY S.A.	30/05/2021	34
524530	21/09/2022	DETRUCALM	5	Mega Labs S.A.	20/09/2021	144
524533	21/09/2022	INCOESPASM	5	Mega Labs S.A.	20/09/2021	144
524534	21/09/2022	LUROXATE	5	Mega Labs S.A.	20/09/2021	144
524535	21/09/2022	LIBERADIL	5	Mega Labs S.A.	25/10/2021	144
524536	21/09/2022	VI-MAX ROEMMERS	5 (S/D)	Mega Labs S.A.	26/10/2021	144
524537	21/09/2022	GARRAXAN	5	LA BUENA ESTRELLA S.A.	20/11/2021	34
524539	21/09/2022	FOTOPTIC	5	Mega Labs S.A.	19/11/2021	144
524541	21/09/2022	ROWE FEM (mixta)	3, 5 y 44	Mega Labs S.A.	22/11/2021	144
524542	21/09/2022	MEGAFARMA	5	Mega Labs S.A.	22/10/2021	144
524543	21/09/2022	EPAREMA	5 (S/D)	TAKEDA GmbH	06/06/2021	34
524545	21/09/2022	EL TERRUÑO	32 y 33	GUSTAVO HECTOR RAFFO COSTEMALLE	27/05/2021	94
524546	21/09/2022	INDURA	1, 3 (S/D), 5 (S/D), 6 (S/D), 7, 8, 9 y 10	INDURA S.A. INDUSTRIA E COMERCIO	24/05/2021	245
524547	21/09/2022	NEUTROL	1 (S/D), 2, 17 y 19	OTTO BAUMGART INDUSTRIA E COMERCIO S/A	06/09/2021	34
524548	21/09/2022	SOSTAC FLUOXETINA (mixta)	5 (S/D)	TEVA URUGUAY S.A.	22/07/2021	245
524549	21/09/2022	AEROSPRAY	3 y 5	TAZ LTDA.	05/09/2021	156
524550	21/09/2022	EL REGALO PERFECTO (mixta)	35, 42, 43, 44 y 45	SHOPPING CENTERS (URUGUAY) S.A.	04/10/2021	34
524555	21/09/2022	AVON ON DUTY	3 (S/D)	AVON PRODUCTS,INC.	12/11/2021	216
524556	21/09/2022	AVON PUR BLANCA	3	AVON PRODUCTS,INC.	09/11/2021	216
524557	21/09/2022	AVON IMARI	3 (S/D)	AVON PRODUCTS, INC.	09/02/2021	216
524558	21/09/2022	FUJITSU (mixta)	9 (S/D), 11 (S/D), 16, 35, 36, 37, 38, 41 y 42	FUJITSU LIMITED	25/06/2021	216
524559	21/09/2022	TENA	5 (S/D), 10 (S/D) y	Essity Hygiene and Health Aktiebolag	03/09/2021	216

N° Exp	Resolución	Denominación	Clases	Titular	Vigencia	Ag.
			16 (S/D)			
524560	21/09/2022	LINCOLN (mixta)	6 (S/D) y 9 (S/D)	THE LINCOLN ELECTRIC COMPANY	12/06/2021	216
524561	21/09/2022	VIRBAC ALIZIN	5 (S/D)	VIRBAC S.A.	12/07/2021	216
524565	21/09/2022	HOWARD JOHNSON	36	HOWARD JOHNSON INTERNATIONAL, INC.	26/07/2021	201
524567	21/09/2022	RURAL	16, 38 y 41	DIARIO RURAL S.A.	27/05/2021	220
524568	21/09/2022	FLUOMIT	5	LABORATORIO CHILE S.A.	21/02/2021	227
524570	21/09/2022	REXONA TEENS HOLIDAYS	3 (S/D)	Unilever Global IP Limited	05/08/2021	136
524574	21/09/2022	CAMPO DI NONNA (mixta)	29	AGOP APRAHAMIAN ZAKARIAN	15/11/2021	94
524576	21/09/2022	LEE KUM KEE	29	LEE KUM KEE COMPANY LIMITED	21/11/2021	181
524577	21/09/2022	LUTAVIT	1 (S/D)	BASF SE	21/08/2021	194
524578	21/09/2022	DKT (mixta)	5, 10, 35 y 44	DKT URUGUAY S.A.	23/11/2021	94
524579	21/09/2022	CATERPILLAR	9 (S/D), 12 (S/D), 35 (S/D), 36 (S/D), 37 (S/D) y 42 (S/D)	CATERPILLAR INC.	01/06/2021	94
524581	21/09/2022	PLADOX	5 (S/D)	BASF SE	10/08/2021	194
524582	21/09/2022	LA NOCHE DE LA NOSTALGIA	41	PABLO LECUEDER ATCHUGARRY	20/11/2021	34
524584	30/09/2022	V (mixta)	18 (S/D) y 25 (S/D)	VALENTINO S.P.A.	07/06/2021	144
524585	22/09/2022	HAWAII 5 CERRO (mixta)	35	DO NACIMENTO, GUILLERMO	25/05/2021	194
524586	22/09/2022	(figurativa)	14	STELUX INTERNATIONAL LICENSING LTD.	16/08/2021	34
524588	22/09/2022	ELLESSE	14	STELUX INTERNATIONAL LICENSING LTD.	16/08/2021	34
524591	27/09/2022	CHARGEURS (mixta)	1, 9, 16, 24, 25, 38, 39, 41 y 42	CHARGEURS	20/11/2021	34
524593	22/09/2022	(figurativa)	12 (S/D)	GENERAL MOTORS LLC	20/06/2021	136
524594	22/09/2022	TIFFANY	1 (S/D), 3 (S/D), 8 (S/D), 22 (S/D) y 26 (S/D)	TIFFANY AND COMPANY	03/06/2021	194
524598	22/09/2022	(figurativa)	35 (S/D)	S. TOUS, S.L.	25/10/2021	212

N° Exp	Resolución	Denominación	Clases	Titular	Vigencia	Ag.
524600	22/09/2022	LACOSTE	14	SPORLOISIRS S.A.	20/11/2021	212
524602	22/09/2022	NITROFOSMA	1	PEDRO MACCIO Y CIA S.A.	30/05/2021	216
524604	22/09/2022	CASH CASH EFECTIVO YA (mixta)	36	CASH S.A.	21/11/2021	34
524605	22/09/2022	ZAK VS. LOS MUTANTES	9 (S/D)	ABBOTT LABORATORIES	21/11/2021	136
524608	22/09/2022	GEISER	32 y 33	Marcelo Hidalgo Dellacasa	16/08/2021	
524609	22/09/2022	NECTAR	25 (S/D)	GUILLERMO CANEN LEWIS	22/06/2021	94
524610	22/09/2022	AR	9 (S/D)	ELECTRONICS TRADEMARK HOLDING COMPANY, LLC	21/11/2021	94
524616	22/09/2022	B BRANDT (mixta)	5	BALIARDA S.A.	27/05/2021	201
524619	22/09/2022	B BRANDT (mixta)	5	BALIARDA S.A.	27/05/2021	201
524623	22/09/2022	BIANCA	5	EUROFARMA URUGUAY S.A.	01/06/2021	201
524624	22/09/2022	INTER PARFUMS	3 (S/D), 18 y 24	INTERPARFUMS S.A	26/07/2021	165
524626	22/09/2022	BETTY CROCKER	29 y 30	GENERAL MILLS, INC.	05/07/2021	144
524627	22/09/2022	(figurativa)	30 (S/D)	GENERAL MILLS, INC.	08/06/2021	144
524628	22/09/2022	FORTESICO	5	EUROFARMA URUGUAY S.A.	12/06/2021	201
524629	22/09/2022	HUGO	3	HUGO BOSS TRADE MARK MANAGEMENT GMBH & CO. KG	15/06/2021	144
524631	22/09/2022	PROCTOGEL	5	EUROFARMA URUGUAY S.A.	12/06/2021	201
524641	22/09/2022	ELISIL (mixta)	6	EBETIR S.A.	21/11/2021	163
524642	22/09/2022	NUBA (mixta)	6	EBETIR S.A.	22/11/2021	163
524647	22/09/2022	RIOLEND	18 y 24	MOLAK S.A.	27/05/2021	220
524648	22/09/2022	MORMAII (mixta)	9 y 14	MORMAII INDÚSTRIA, COMÉRCIO, IMPORTAÇÃO E EXPORTAÇÃO DE ARTIGOS ESPORTIVOS LTDA.	22/06/2021	163
524649	30/09/2022	GRANJA LA CUMBRE L493 CW COLONIA SUIZA (mixta)	29 (S/D)	Enrique Celio	25/07/2021	
524650	22/09/2022	PINAVALT	5 (S/D)	TAKEDA GmbH	30/05/2021	34
524651	22/09/2022	CREAMFIELDS (mixta)	9 (S/D), 16 (S/D), 18 (S/D), 25 (S/D), 38 (S/D), 41 (S/D),	CREAM GLOBAL LIMITED	30/05/2021	34

N° Exp	Resolución	Denominación	Clases	Titular	Vigencia	Ag.
			42 (S/D) y 43 (S/D)			
524652	22/09/2022	TRAUMALAN	5	URUFARMA S.A.	03/06/2021	34
524653	22/09/2022	BLOKESAL	5 y 31	BARRACA DEAMBROSI S.A.	27/05/2021	154
524655	22/09/2022	SKIP TECNOLOGIA POLYFIBER	3 (S/D)	Unilever Global IP Limited	05/08/2021	136
524656	22/09/2022	LINDOLFO (mixta)	41 y 43	BEGAN S.A.	27/05/2021	186
524658	22/09/2022	(figurativa)	34 (S/D)	CHINA TOBACCO HUNAN INDUSTRIAL CO. LTD.	01/06/2021	201
524659	22/09/2022	(figurativa)	34 (S/D)	CHINA TOBACCO HUNAN INDUSTRIAL CO. LTD.	01/06/2021	201
524662	22/09/2022	POLYFLOR	27	POLYFLOR LIMITED	07/06/2021	201
524663	22/09/2022	GATORADE	30 (S/D)	STOKELY-VAN CAMP, INC.	11/06/2021	201
524664	22/09/2022	GAMBERONI	1, 9 y 17	María Luciana Negro Demontel	15/07/2021	219
524665	22/09/2022	ACP ALTA CAPACITACION PROFESIONAL (mixta)	41 (S/D)	MARCELO DANIEL ERCOLANO y JORGE DANIEL PRESAS	30/05/2021	201
524667	22/09/2022	MARY STUART (mixta)	3 (S/D)	RIGALT S.A.	26/11/2021	165
524672	22/09/2022	TASCANI	25	ZUKATEK S.A.	27/05/2021	245
524675	23/09/2022	KLACID	5	ABBOTT LABORATORIES	29/10/2021	136
524676	23/09/2022	CONTINENTAL (mixta)	7 (S/D) y 11 (S/D)	AB ELECTROLUX	12/06/2021	201
524680	23/09/2022	NOVIAL	5 (S/D) y 10 (S/D)	Aspen Global Incorporated	12/06/2021	201
524686	23/09/2022	QQ (mixta)	12 y 37	Chery New Energy Automobile Technology Co., Ltd.	16/06/2021	218
524687	23/09/2022	ROYAL	36	SEGUROS SURA S.A.	27/11/2021	218
524688	23/09/2022	ROYAL INSURANCE (mixta)	36	SEGUROS SURA S.A.	19/11/2021	218
524699	23/09/2022	FOX CARGO (mixta)	39	FOX CARGO S.A.	13/09/2021	201
524702	23/09/2022	MATARAZZO	5, 29, 30, 31 y 42	MOLINOS IP S.A.	26/11/2021	34
524703	23/09/2022	OLITALIA (mixta)	29 (S/D)	OLITALIA S.R.L.	22/06/2021	194
524706	23/09/2022	ANDA (mixta)	35, 36, 38, 43, 44 y 45	ASOCIACIÓN NACIONAL DE AFILIADOS (A.N.D.A)	21/11/2021	94
524712	23/09/2022	RIFADOM DOMINGUEZ	5	LABORATORIOS DOMINGUEZ S.A.	03/06/2021	144
524716	23/09/2022	LEZALEZ (mixta)	25 (S/D)	LUNENDER S.A.	02/08/2021	34

N° Exp	Resolución	Denominación	Clases	Titular	Vigencia	Ag.
524719	23/09/2022	ARNO (mixta)	8, 9 y 11	SEB DO BRASIL PRODUTOS DOMÉSTICOS LTDA.	27/11/2021	34
524724	23/09/2022	NORTON	3 (S/D), 7 (S/D) y 8 (S/D)	SAINT-GOBAIN ABRASIVES INC.	12/06/2021	216
524729	23/09/2022	ETHICAL PHARMA	42 (S/D)	ETHICAL PHARMA S.A.	21/11/2021	212
524732	23/09/2022	VIVO	9, 16, 35, 38 y 42	VIVO MOBILE COMMUNICATION CO., LTD.	30/11/2021	201
524733	28/09/2022	FECINOLE	5 (S/D)	ARMEN CARLOS AVCHARIAN KEHYAIAN	07/06/2021	189
524734	23/09/2022	MM MICRO MACRO LA ECONOMIA, MAS CERCA (mixta)	35 (S/D)	MACROMERCADO MAYORISTA S.A.	26/11/2021	189
524736	23/09/2022	AGUILA	30 (S/D)	ARCOR S.A.I.C.	31/05/2021	154
524743	23/09/2022	MIOLO (mixta)	33	VINICOLA MIOLO LTDA. - ME.	24/08/2021	34
524744	23/09/2022	ZOMARIST	5 (S/D)	NOVARTIS AG	28/11/2021	201
524745	23/09/2022	NEXT	3	URUQUIM S.A.	27/06/2021	34
524747	23/09/2022	DON PEPPERONE	29 y 30	DON PEPPERONE S.R.L.	21/11/2021	245
524749	23/09/2022	3 TCC (mixta)	38 y 41	TRACTORAL S.A.	01/06/2021	245
524750	23/09/2022	KITOSCELL	3	GRUPO MEDIFARMA S.A. DE C.V.	01/06/2021	245
524751	23/09/2022	KITOSCELL	5	GRUPO MEDIFARMA S.A. DE C.V.	01/06/2021	245
524753	23/09/2022	BLANGINO (mixta)	19 y 35	BLANGINO, JUAN BAUTISTA NORBERTO	18/11/2021	201
524756	30/09/2022	BOLLÉ	9 (S/D)	Bollé Brands (FRANCE)	03/06/2021	144
524759	23/09/2022	FRICO (mixta)	9	FRICO AB	07/06/2021	144
524763	23/09/2022	TIME-LIFE	9 (S/D) y 16 (S/D)	TI Gotham INC.	31/05/2021	194
524765	23/09/2022	UNI-RAT	5	BELTRAME & CIA.	28/11/2021	144
524793	12/09/2022	VACATIONS	3 (S/D)	Unilever Global IP Limited	05/08/2021	136
524799	12/09/2022	INSIGHT	12 (S/D)	HONDA MOTOR CO., LTD.	31/08/2021	94
524800	12/09/2022	V-MEN (mixta)	12 (S/D)	HONDA MOTOR CO., LTD.	15/08/2021	94
524802	12/09/2022	RIO DE LA PLATA	35	SOLDO HNOS. S.A.	12/06/2021	245
524803	12/09/2022	EAGLE VIEW INVESTING (mixta)	35 y 36	IGNACIO VICTOR GOÑI	16/06/2021	220

N° Exp	Resolución	Denominación	Clases	Titular	Vigencia	Ag.
524806	12/09/2022	DUDDY (mixta)	16	SOLDO HNOS. S.A.	31/08/2021	245
524807	12/09/2022	SOLDO	35 y 43	SOLDO HNOS. S.A.	06/05/2021	245
524808	12/09/2022	PRIMOR	16 (S/D)	SOLDO HNOS. S.A.	10/06/2021	245
524809	12/09/2022	TOTO (mixta)	18, 25, 35 (S/D) y 45	SANARY S.A.	30/11/2021	212
524810	13/09/2022	HERMES	3, 8, 9, 14, 16, 18, 20, 21, 24, 25, 28 y 34	HERMES INTERNATIONAL	12/06/2021	245
524811	13/09/2022	HERMES (mixta)	35	HERMES INTERNATIONAL	13/07/2021	245
524814	13/09/2022	FARMASHOP (mixta)	3, 10, 30, 31, 35, 39, 40, 42, 43, 44 y 45	COBOE S.A.	28/11/2021	212
524815	13/09/2022	ITALÍNEA MÓVEIS (mixta)	35 (S/D)	ITALÍNEA INDÚSTRIA DE MÓVEIS LTDA.	09/06/2021	245
524817	13/09/2022	C CYNSA DESDE 1954 / SINCE 1954 NUESTRA EXPERIENCIA HACE LA DIFERENCIA... OUR KNOWLEDGE MAKES THE DIFFERENCE... (mixta)	35, 39 y 43	CYNSA S.A.	14/06/2021	212
524818	13/09/2022	TOMAG	5	LABORATORIOS TEMIS LOSTALÓ S.A.	12/06/2021	192
524819	13/09/2022	ALCANCE CUIDAMOS LO QUE MAS QUERES	45	MARÍA INÉS GARCÍA ÁLVAREZ	08/07/2021	192
524820	13/09/2022	IDEAL (mixta)	23 y 26	DIMELOR S.A.	06/07/2021	192
524821	13/09/2022	MEGAMECTIN	5 (S/D)	ELANCO TIERGESUNDHEIT AG	09/08/2021	192
524822	13/09/2022	OPTIVIX	5 (S/D), 10 (S/D) y 20 (S/D)	ELANCO TIERGESUNDHEIT AG	18/08/2021	192
524823	13/09/2022	LEE	3 (S/D)	Laboratorio Ballerina Ltda.	07/06/2021	245
524824	13/09/2022	BIOFRUTA CONAPROLE	29 y 30	COOPERATIVA NACIONAL DE PRODUCTORES DE LECHE (CONAPROLE)	22/10/2021	194
524825	13/09/2022	MAXIMAX	30	COOPERATIVA NACIONAL DE PRODUCTORES DE LECHE	25/10/2021	194

N° Exp	Resolución	Denominación	Clases	Titular	Vigencia	Ag.
				(CONAPROLE)		
524826	13/09/2022	BALDARAN	29 (S/D)	SAVENCIA SA	15/11/2021	192
524827	13/09/2022	FRYMON (mixta)	11 y 37	Frymon S.A.	12/10/2021	192
524828	13/09/2022	(figurativa)	25, 28 y 42 (S/D)	NICKLAUS COMPANIES LLC	16/11/2021	245
524829	13/09/2022	GUAPA	14 (S/D) y 26	ANDRES GREGORINI	30/11/2021	212
524830	13/09/2022	LA YERBA DE MI PAÍS	30 y 35	CANARIAS S.A.	26/11/2021	94
524831	13/09/2022	ROADTEC	4	EFICE S.A.	28/11/2021	94
524836	13/09/2022	OREO	30	INTERCONTINENTAL GREAT BRANDS LLC	05/09/2021	227
524837	13/09/2022	TRIDENT (mixta)	30 (S/D)	INTERCONTINENTAL GREAT BRANDS LLC	12/06/2021	227
524838	13/09/2022	MEDIO & MEDIO HÉCTOR FARAUT (mixta)	33 (S/D)	DIEGO COMESAÑA DARDANELLI y ELIANA COMESAÑA DARDANELLI	08/06/2021	245
524839	13/09/2022	NIKITO (mixta)	30 (S/D)	M DIAS BRANCO S/A INDÚSTRIA E COMÉRCIO DE ALIMENTOS	13/06/2021	34
524840	13/09/2022	SIERRA BLANCA (mixta)	29	ACEITERA GENERAL DEHEZA S.A.	07/06/2021	94
524841	13/09/2022	TEUTO	5 (S/D)	LABORATÓRIO TEUTO BRASILEIRO S/A	03/09/2021	34
524842	13/09/2022	W STANDARD THE WINNING CHOICE (mixta)	12 (S/D)	PABLO ERNESTO BARDELLI	24/06/2021	34
524843	13/09/2022	DOÑA INÉS ...DULCES TENTACIONES (mixta)	30 y 43	MARCELA EDITH RODRÍGUEZ CARBAJAL Y DANIELA INÉSRODRÍGUEZ CARBAJAL SOCIEDAD DE HECHO	07/06/2021	
524844	13/09/2022	MR. BEEF PREMIUM (mixta)	29	AUPCIN ASOCIACION URUGUAYA DE PRODUCTORES DE CARNE INTENSIVA NATURAL	26/11/2021	34
524846	14/09/2022	CARQUEJA 101	32	PREMIUMBEVS S.A.	03/06/2021	212
524852	14/09/2022	SATIN BODY	3 (S/D)	MARY KAY INC.	18/08/2021	144
524862	14/09/2022	FRESITA	33	VIÑA CASAL DE GORCHS S.A.	12/06/2021	201
524863	14/09/2022	(figurativa)	43	MCLANE COMPANY, INC.	12/06/2021	201

N° Exp	Resolución	Denominación	Clases	Titular	Vigencia	Ag.
524864	14/09/2022	EXILINE	3 (S/D)	MAURICIO LLANES	03/06/2021	220
524866	14/09/2022	BIG MAMA	29, 30 y 43	BABAT BURCATOVSKY, GREGORIO	29/06/2021	189
524867	14/09/2022	LOGTRA - INSTITUTO DE ESPECIALIDADES LABORALES EN LOGISTICA Y TRANSPORTE (mixta)	41	RODRIGUEZ ORCAJO, LIANA BEATRIZ	08/06/2021	189
524872	14/09/2022	DUSTRA	5	LAZAR S.A.	07/07/2021	165
524873	14/09/2022	RUSTIK	5	LAZAR S.A.	07/07/2021	165
524874	14/09/2022	REBIJECT	10	MERCK KGaA	12/06/2021	129
524876	14/09/2022	LENVIA	5	LAZAR S.A.	07/07/2021	165
524877	14/09/2022	FOSFOLAX	5	LABORATORIO GADOR S.A.	11/07/2021	165
524878	14/09/2022	C (mixta)	25	HBI Branded Apparel Enterprises, LLC	16/08/2021	136
524879	14/09/2022	VAINILLAS SIEMPRERICAS	30 (S/D)	HORMADIL S.A.	08/06/2021	129
524880	14/09/2022	SINDOPIL	5	LABORATORIO GADOR S.A.	12/07/2021	165
524881	14/09/2022	MEFORIN	5	LABORATORIO GADOR S.A.	12/07/2021	165
524882	14/09/2022	MELITA (mixta)	30 (S/D)	DISGAL S.A.	25/07/2021	165
524883	14/09/2022	FINITAS BLUE THINS	30	EL TRIGAL S.A.	28/07/2021	165
524884	14/09/2022	CACAO DEL PLATA	30 (S/D)	CACAO DEL PLATA S.A.	29/07/2021	165
524885	14/09/2022	COMPO (mixta)	1 y 5	COMPO GmbH	09/11/2021	165
524886	16/09/2022	BLANCA DOLORES	30 (S/D)	Molinos Dolores S.A.	13/07/2021	144
524888	16/09/2022	HARINA BLANQUITA (mixta)	30 (S/D)	Molino Dolores S.A.	13/07/2021	144
524889	16/09/2022	VILLA BLANCA	30 (S/D)	Molinos Dolores S.A.	15/07/2021	144
524892	16/09/2022	SEMANA DE LA CERVEZA DE PAYSANDU NORTEÑA LA CERVEZA DEL URUGUAY (mixta)	32 (S/D) y 41	FNC SOCIEDAD ANONIMA	26/07/2021	144
524893	16/09/2022	GIRAFFAS	29 (S/D)	GIRAFFAS INTERNACIONAL PARTICIPAÇÕES LTDA	03/06/2021	34
524895	16/09/2022	DONFRUTERO (mixta)	29, 30 y 31	SILCOM S.A.	29/07/2021	144
524896	16/09/2022	(figurativa)	25 (S/D)	CERVECERIA MODELO DE MEXICO S.de R.L. de C.V.	21/10/2021	144
524897	16/09/2022	SPAR (mixta)	3, 5, 21, 29, 30, 32 y	SPAR INTERNATIONAL B.V.	15/09/2021	34

N° Exp	Resolución	Denominación	Clases	Titular	Vigencia	Ag.
			33			
524898	16/09/2022	NASHA COSMETICS (mixta)	3 (S/D)	GIOVANNA BABY COMÉRCIO E INDÚSTRIA EIRELLI-ME	22/06/2021	144
524900	16/09/2022	AUGUST SILK	25 (S/D)	BRAMEAD INTERNATIONAL INC.	03/06/2021	194
524901	16/09/2022	DAILIES TOTAL 1	9 (S/D)	ALCON INC.	06/07/2021	34
524904	16/09/2022	ALCON (mixta)	5 (S/D)	ALCON INC.	30/09/2021	34
524908	16/09/2022	FAVORITA	30 (S/D)	MOLINOS RIO DE LA PLATA S.A.	03/12/2021	34
524910	16/09/2022	HAOJUE (mixta)	12 (S/D)	JIANGMEN DACHANGJIANG GROUP CO., LTD.	29/06/2021	34
524912	16/09/2022	EL CANAL DE LAS ESTRELLAS	35, 38 y 41	MOUNTRIGI MANAGEMENT GROUP, LTD.	13/07/2021	212
524913	16/09/2022	ROMMANEL (mixta)	14	MMA INDÚSTRIA E COMÉRCIO DE BIJUTERIAS LTDA.	16/07/2021	212
524915	16/09/2022	TELEVISA DEPORTES NETWORK	9, 38 y 41	MOUNTRIGI MANAGEMENT GROUP LTD.	27/07/2021	212
524918	16/09/2022	REINKE	11	REINKE MANUFACTURING CO., INC.	26/08/2021	201
524919	16/09/2022	UN MUNDO DE SALUD PARA NUESTRA GENTE	5	LABORATORIOS VIJOSA S.A. DE C.V.	26/11/2021	201
524920	19/09/2022	SPIRIVA	5 (S/D)	BOEHRINGER INGELHEIM PHARMA GMBH & CO. KG	12/06/2021	201
524921	19/09/2022	CHUNKY MONKEY	30	Unilever IP Holdings B.V.	14/08/2021	136
524923	19/09/2022	MILHOJAS	29 (S/D), 30 (S/D) y 31 (S/D)	MOREIRA BESSO, GERARDO DANIEL	07/06/2021	189
524930	19/09/2022	VENUS	38 y 41	CLAXSON MEDIA, LLC.	27/06/2021	201
524934	19/09/2022	DALGION	5	GRAMON BAGO DE URUGUAY S.A.	12/06/2021	212
524935	19/09/2022	GERIATON	5	GRAMON BAGO DE URUGUAY S.A.	12/06/2021	212
524936	19/09/2022	AUDILON	5	GRAMON BAGO DE URUGUAY S.A.	12/06/2021	212
524938	19/09/2022	SUADOLIN	5	GRAMON BAGO DE URUGUAY S.A.	12/06/2021	212
524939	19/09/2022	PREGALDOX H	5	GRAMON BAGO DE URUGUAY S.A.	12/06/2021	212
524940	19/09/2022	DOLOMIN	5	GRAMON BAGO DE URUGUAY S.A.	12/06/2021	212

N° Exp	Resolución	Denominación	Clases	Titular	Vigencia	Ag.
524941	19/09/2022	SYFY	9, 28, 38 y 41	UNIVERSAL CITY STUDIOS LLC	01/07/2021	94
524942	19/09/2022	PUEBLO DEL SOL	33	ESTABLECIMIENTO JUANICO S.A.	09/08/2021	201
524943	19/09/2022	SUPERMERCADO EXPRES (mixta)	35	HENDERSON & CIA. S.A.	24/11/2021	181
524946	19/09/2022	TONVAL	5	DELIBRA S.A.	12/06/2021	245
524947	19/09/2022	LE TREFLE (mixta)	25	LE TREFLE LTDA	25/10/2021	144
524948	19/09/2022	PEGASOLA	1 (S/D), 2 (S/D), 7 (S/D), 9 (S/D), 16 (S/D), 20 (S/D) y 28 (S/D)	VIGOR S.A.C.I. y F.	12/06/2021	245
524949	20/09/2022	ISLOTIN CRAVERI (mixta)	5 (S/D)	CRAVERI S.A.I.C.	03/09/2021	144
524950	19/09/2022	PEGASOLA	1 (S/D), 2 (S/D), 7 (S/D), 9 (S/D), 16 (S/D), 20 (S/D) y 28 (S/D)	VIGOR S.A.C.I. y F.	12/06/2021	245
524959	19/09/2022	NUEVOCENTRO SHOPPING	3, 16, 18, 20, 21, 24, 25, 28, 29, 30, 35, 36, 38, 41, 43 y 44	NUEVOCENTRO SOCIEDAD ANONIMA	21/10/2021	34
524961	19/09/2022	(figurativa)	33 (S/D) y 41 (S/D)	THE GLENLIVET DISTILLERS LTD.	16/08/2021	205
524962	19/09/2022	ABSOLUT COUNTRY OF SWEDEN VODKA (mixta)	33 (S/D)	THE ABSOLUT COMPANY AKTIEBOLAG	30/09/2021	221
524963	19/09/2022	TRETBHIREAS BUNAITEACHD FOUNDED 1801 (mixta)	6 (S/D), 16 (S/D) y 33 (S/D)	CHIVAS HOLDINGS (IP) LIMITED	07/07/2021	205
524966	19/09/2022	1/4 DE SIGLO	33	ROSES HNOS. S.R.L.	07/06/2021	201
524967	20/09/2022	LA PRAIRIE-LA PRAIRIE-LA PRAIRIE-LA PRAIRIE(tridimensional)	3 (S/D)	LABORATOIRES LA PRAIRIE SA	13/06/2021	201
524968	20/09/2022	LA PRAIRIE-LA PRAIRIE(tridimensional)	3 (S/D)	LABORATOIRES LA PRAIRIE SA	13/06/2021	201
524973	20/09/2022	SECURIT	19 (S/D) y 21 (S/D)	SAINT-GOBAIN GLASS FRANCE	07/06/2021	194
524974	20/09/2022	LA CRIOLLA	16 (S/D) y 28	CORSI GHIGA, ANABELLA	13/06/2021	194
524978	20/09/2022	DELPERRITO (mixta)	30	INPROPAN SRL	07/06/2021	129
524983	20/09/2022	H DOS O (mixta)	37	PRANO FERNANDEZ DE LUCO,	30/06/2021	189

N° Exp	Resolución	Denominación	Clases	Titular	Vigencia	Ag.
				FRANCISCO JULIO		
524988	20/09/2022	ENERGY (mixta)	12 (S/D)	COMPAGNIE GENERALE DES ETABLISSEMENTS MICHELIN	16/06/2021	201
524989	20/09/2022	TOGO	30	BARILLA G. E R. FRATELLI - SOCIETÀ PER AZIONI	14/11/2021	179
524990	20/09/2022	RINGO	30	BARILLA G. E R. FRATELLI - SOCIETÀ PER AZIONI	14/11/2021	179
524991	20/09/2022	REXPART DECK XP	2 (S/D)	SWIMC LLC	16/06/2021	201
524993	20/09/2022	LOXON CLIMAS	2 (S/D)	SWIMC LLC	16/06/2021	201
524994	20/09/2022	LUSOL SELECT	2 (S/D)	PINTURAS INDUSTRIALES S.A.	20/06/2021	201
524995	20/09/2022	OPI	3	OPI PRODUCTS, INC	22/06/2021	201
524999	20/09/2022	(tridimensional)	3 (S/D)	LABORATOIRES LA PRAIRIE S.A.	23/06/2021	201
525001	20/09/2022	DOCMORRIS (mixta)	5 (S/D), 35 (S/D), 42 (S/D) y 44 (S/D)	Zur Rose Group AG	27/06/2021	219
525002	20/09/2022	SEMPVIS	5 (S/D)	GlaxoSmithKline Biologicals S.A.	08/08/2021	216
525003	20/09/2022	TUMS (mixta)	5	GlaxoSmithKline Consumer Healthcare (US) IP LLC	05/07/2021	216
525005	20/09/2022	(figurativa)	5 (S/D)	BAYER CONSUMER CARE AG	23/08/2021	221
525007	20/09/2022	MOVENTO	5 (S/D)	BAYER INTELLECTUAL PROPERTY GmbH	08/08/2021	221
525010	20/09/2022	CHUCARO	5 (S/D)	BAYER INTELLECTUAL PROPERTY GmbH	04/08/2021	221
525012	21/09/2022	UNGRIA	35, 38, 42 y 45	UNGRIA PATENTES Y MARCAS, S.A.	30/11/2021	144
525013	21/09/2022	HOT WHEELS (mixta)	9, 12, 16, 18, 25 y 28	MATTEL, INC.	29/08/2021	94
525014	21/09/2022	BARBIE	3, 5, 6, 9, 14 y 20	MATTEL, INC.	10/08/2021	94
525015	21/09/2022	BARBIE	25	MATTEL, INC.	26/11/2021	94
525016	21/09/2022	SKELETOR	28	MATTEL, INC.	30/11/2021	94
525022	21/09/2022	(figurativa)	23 (S/D) y 24 (S/D)	CIA. FIACAO E TECIDOS GUARATINGUETA	28/06/2021	144
525024	21/09/2022	ARCOR CANDY MIX	30 y 43	ARCOR S.A.I.C.	08/06/2021	154

N° Exp	Resolución	Denominación	Clases	Titular	Vigencia	Ag.
525032	21/09/2022	FAMA (mixta)	11 (S/D)	INVERFIN S.A.E.C.A.	17/06/2021	201
525035	21/09/2022	(figurativa)	9 (S/D) y 14 (S/D)	PANAMA JACK INTERNATIONAL, INC.	09/06/2021	245
525038	21/09/2022	PANAMA JACK	9 (S/D) y 14 (S/D)	PANAMA JACK INTERNATIONAL, INC.	09/06/2021	245
525039	21/09/2022	TAIGA (mixta)	12	INVERFIN S.A.E.C.A.	17/06/2021	201
525052	21/09/2022	(figurativa)	5 (S/D)	IPR PHARMACEUTICALS INC	05/12/2021	201
525054	21/09/2022	Z - ZUCCHINO (mixta)	37	ZUCCHINO MATRELLA, DARIO ERNESTO	28/06/2021	245
525055	21/09/2022	LAR (mixta)	43 y 44	LAGUBEL S.A.	24/06/2021	212
525056	21/09/2022	EVEREADY	11 (S/D)	Energizer Brands, LLC	12/07/2021	194
525069	21/09/2022	PARALINA	5 (S/D)	RAQUEL SZTEJNGAUER FUTTERMANN	12/06/2021	212
525076	22/09/2022	TOMMY HILFIGER	25	TOMMY HILFIGER LICENSING LLC	23/07/2021	194
525077	21/09/2022	CHICKEN OF THE SEA (mixta)	29	Tri-Union Seafoods, LLC.	09/06/2021	194
525078	21/09/2022	GENTORI (mixta)	34 (S/D)	NANYANG BROTHERS TOBACCO COMPANY LIMITED	28/11/2021	194
525079	21/09/2022	MICOSEB PORTINCO	5	PORTINCO SOCIEDAD ANÓNIMA	23/06/2021	189
525080	21/09/2022	ARTRICARE PORTINCO	5	PORTINCO SOCIEDAD ANÓNIMA	20/07/2021	189
525084	22/09/2022	SALVATORE FERRAGAMO (mixta)	3 y 9 (S/D)	SALVATORE FERRAGAMO S.P.A.	11/07/2021	245
525085	22/09/2022	(figurativa)	18 y 25	SALVATORE FERRAGAMO S.P.A.	25/09/2021	245
525086	22/09/2022	SUCHARD (mixta)	30 (S/D)	KRAFT FOODS SCHWEIZ HOLDING GMBH	05/07/2021	245
525087	22/09/2022	NOMINATION	14	NOMINATION DI ANTONIO E PAOLO GENSINI S.N.C.	21/11/2021	245
525090	22/09/2022	RINSO	3 (S/D)	Unilever Global IP Limited	21/08/2021	136
525092	22/09/2022	BABY-G	14	Casio Keisanki Kabushiki Kaisha (Casio Computer Co., Ltd.)	30/08/2021	192
525094	22/09/2022	G-SHOCK	14	Casio Keisanki Kabushiki Kaisha (Casio Computer Co., Ltd.)	30/08/2021	192
525096	22/09/2022	WELCH'S	29 (S/D)	Welch Foods Inc., A Cooperative	03/12/2021	194

N° Exp	Resolución	Denominación	Clases	Titular	Vigencia	Ag.
525098	22/09/2022	GALVUS (mixta)	5 (S/D)	NOVARTIS AG	05/12/2021	201
525099	22/09/2022	ANTONY MORATO	3 (S/D), 9 (S/D), 14 (S/D), 16 (S/D), 18 (S/D), 24 (S/D) y 25 (S/D)	R.C. TRADEMARKS S.r.l.	17/06/2021	192
525100	22/09/2022	CEOURUGUAY (mixta)	16 y 42	PRICEWATERHOUSECOOPERS LTDA.	08/07/2021	181
525102	22/09/2022	PATANASE	5 (S/D)	NOVARTIS AG	31/10/2021	201
525103	22/09/2022	FOLLITRIN	5 (S/D)	FERRING B. V.	05/09/2021	181
525104	22/09/2022	CHANCE	25	JUAN ARTOLA PUERTA	27/11/2021	34
525106	22/09/2022	ANDY.DISC (mixta)	10	FRESENIUS MEDICAL CARE DEUTSCHLAND GMBH	09/07/2021	34
525107	22/09/2022	UNDICI	20 y 25	MELACOR S.A.	14/06/2021	94
525108	22/09/2022	(figurativa)	18 y 25	SALVATORE FERRAGAMO S.P.A.	25/09/2021	245
525109	22/09/2022	CELLU 3D	3 (S/D) y 5 (S/D)	INDUSTRIA FARMACEUTICA CANTABRIA, S.A.	23/02/2021	34
525111	22/09/2022	DAPIE	35	COLIMAN S.A.	14/08/2021	34
525112	22/09/2022	LARES (mixta)	39	PAOLA ANNA PERELLI FRAGA	26/10/2021	34
525113	22/09/2022	BUENA VISTA	33	FEDERICO ALEJANDRO BONOMI	16/08/2021	144
525118	22/09/2022	COXEL	5 (S/D)	URUFARMA S.A.	12/11/2021	34
525121	22/09/2022	MONTEVIDEO SHOPPING ON LINE (mixta)	35, 38, 42, 43, 44 y 45	SHOPPING CENTERS (URUGUAY) S.A.	29/11/2021	34
525122	22/09/2022	LEGACY	24	FLORENCIA MARIA AZQUETA SECCO	22/10/2021	34
525124	22/09/2022	LA SOLANA (mixta)	43	RODOLFO EDUARDO MERZARIO	28/07/2021	34
525126	22/09/2022	CASH CASH PLATA EN MANO (mixta)	35 y 36	CASH S.A.	27/11/2021	34
525127	22/09/2022	CASH EFECTIVO SI (mixta)	35	CASH S.A.	28/11/2021	34
525128	22/09/2022	PUNTA DEL ESTE POLO CLUB	36 y 41	TAYMOOR S.A.	24/06/2021	34
525132	22/09/2022	DICLORAZIDA	5	ICU-VITA S.A.	12/06/2021	201
525133	22/09/2022	FURANPRED	5	ICU-VITA S.A.	12/06/2021	201

N° Exp	Resolución	Denominación	Clases	Titular	Vigencia	Ag.
525134	22/09/2022	RENAULT	36, 37 y 39	RENAULT S.A.S.	21/06/2021	201
525135	23/09/2022	RENAULT MINUTO	12, 37 y 39	RENAULT S.A.S.	21/06/2021	201
525136	23/09/2022	EXPRESSION	12	RENAULT S.A.S.	28/06/2021	201
525137	23/09/2022	KALTENBERG (mixta)	43	SCHLOSS KALTENBERG KÖNIGLICHE HOLDING UND LIZENZ KG	22/06/2021	201
525138	23/09/2022	KALTENBERG (mixta)	32 (S/D)	KÖNIG LUDWIG INTERNATIONAL GmbH & CO. KG.	22/06/2021	201
525140	23/09/2022	CICLIDON 20	5	KANGSHENYUNGA S.A.	22/10/2021	136
525141	23/09/2022	MACTEC	5	KANGSHENYUNGA S.A.	27/11/2021	136
525142	23/09/2022	3F	6 (S/D)	SOFIND S.A.	12/06/2021	219
525143	23/09/2022	LOS REYES MAGOS	28	FEDERICO CALACHA	12/09/2021	212
525144	23/09/2022	(figurativa)	36 (S/D)	GRUPO FINANCIERO INBURSA, S.A.B. DE C.V.	15/06/2021	94
525145	23/09/2022	INBURSA	36 (S/D)	GRUPO FINANCIERO INBURSA, S.A.B. DE C.V.	15/06/2021	94
525148	23/09/2022	PUNTA DEL ESTE POLO & COUNTRY CLUB (mixta)	36 y 41	TAYMOOR S.A.	05/07/2021	34
525150	23/09/2022	DAB	32 (S/D)	Dortmunder Actien-Brauerei-GmbH	16/09/2021	219
525153	23/09/2022	F FREE SPECIAL FILTER (mixta)	34 (S/D)	SOUZA CRUZ LTDA	08/07/2021	194
525156	23/09/2022	ABADIA DE SANCAMPIO	33	Bodegas Terras Gauda, S.A.	03/08/2021	144
525157	23/09/2022	TERRAS GAUDA (mixta)	33	Bodegas Terras Gauda, S.A.	03/08/2021	144
525159	23/09/2022	HTC (mixta)	9 (S/D)	HTC CORPORATION	10/06/2021	34
525161	23/09/2022	RINCON INFANTIL (mixta)	41 (S/D)	GIOGA E HIJOS S.R.L.	11/06/2021	104
525164	23/09/2022	DIGI (mixta)	9 (S/D)	TERAOKA SEIKO CO., LTD.	11/08/2021	194
525169	23/09/2022	OCTANINE F	5 (S/D)	Octapharma AG	21/11/2021	219
525174	23/09/2022	PURAVIDA	32	BARRACA DEAMBROSI S.A.	12/06/2021	154
525175	23/09/2022	RICH (mixta)	7 (S/D)	SHANGHAI TONGXUE INDUSTRIAL CO., LTD.	19/07/2021	201
525177	23/09/2022	DRAMAMINE	5 (S/D)	JOHNSON & JOHNSON	12/06/2021	194

N° Exp	Resolución	Denominación	Clases	Titular	Vigencia	Ag.
525180	23/09/2022	SMARTABLATE	10 (S/D)	Biosense Webster, Inc.	22/06/2021	194
525183	23/09/2022	ITATÍ (mixta)	30 y 32	ANDREA BETOLAZA	08/06/2021	168
525184	23/09/2022	METINAL	5	LA BUENA ESTRELLA S.A.	22/10/2021	34
525186	23/09/2022	ANTONIO BANDERAS THE SECRET (mixta)	3 (S/D)	ANTONIO BANDERAS LIMITED	18/11/2021	181
525196	23/09/2022	ONLINE RUMBO	39, 41 y 43	RED UNIVERSAL DE MARKETING Y BOOKINGS ONLINE, S.A.	16/10/2021	144
525202	23/09/2022	MASYMAS (mixta)	35 (S/D), 42, 43, 44 y 45	Abiler S.A.	12/06/2021	101
525204	23/09/2022	OASIS TERMAL (mixta)	41, 43 y 44	ONDULER S.A.	27/07/2021	201
525207	23/09/2022	N NUÑEZ (mixta)	39	DIOMAR GREGORIO NUÑEZ PEREIRA	12/06/2021	101
525209	23/09/2022	SELLAPLAST	2	SINTEPLAST S.A.	12/06/2021	245
525212	23/09/2022	NATIVA TECNOLOGÍA Y DISEÑO EN ALMOHADAS (mixta)	20 (S/D)	LIMANSKY SA	24/11/2021	216
525214	26/09/2022	STORCK	29 y 30	August Storck KG	11/07/2021	240
525218	26/09/2022	HUSQVARNA	7 (S/D)	HUSQVARNA AKTIEBOLAG	10/07/2021	218
525222	26/09/2022	EL PULPITO	1	SIDELA S.A.	28/06/2021	240
525225	26/09/2022	ROGAINE	3 (S/D)	JOHNSON & JOHNSON	23/06/2021	194
525227	26/09/2022	CAM-LOC	10 (S/D)	JOHNSON & JOHNSON	28/06/2021	194
525229	26/09/2022	INCIVO	5 (S/D)	JOHNSON & JOHNSON	19/07/2021	194
525230	26/09/2022	DERMABOND	5 (S/D)	JOHNSON & JOHNSON	16/08/2021	194
525231	26/09/2022	NO MORE TEARS	3 y 5	JOHNSON & JOHNSON	11/07/2021	194
525232	26/09/2022	ISMUS	10 (S/D)	Biosense Webster, Inc.	14/08/2021	194
525233	26/09/2022	HEALON5 (mixta)	5 (S/D) y 10 (S/D)	AMO UPPSALA AB	11/07/2021	194
525234	26/09/2022	LUX TOQUE LUMINOSO	30 (S/D)	Unilever Global IP Limited	13/09/2021	136
525239	26/09/2022	ZONACELULAR (mixta)	35	Grimifer S.A.	13/06/2021	94
525240	26/09/2022	TOLDART - ARTE EN LONAS (mixta)	22 (S/D)	FIDATEC SOCIEDAD ANÓNIMA	15/06/2021	189
525241	26/09/2022	(figurativa)	9 (S/D), 14 (S/D), 18 (S/D) y 25 (S/D)	Margaretha International GmbH	12/07/2021	136

N° Exp	Resolución	Denominación	Clases	Titular	Vigencia	Ag.
525242	26/09/2022	MF TECNOLOGIA (mixta)	6 y 37	MF TECNOLOGIA S.A.	15/11/2021	34
525243	26/09/2022	CAMPOSUR	29	BRONCELIL S.A.	11/10/2021	34
525245	26/09/2022	REGENESIS 70	5	URUFARMA S.A.	28/11/2021	34
525246	26/09/2022	STONE (mixta)	25 (S/D)	LULITRADE LLC	15/06/2021	118
525253	27/09/2022	BALLARD	10 (S/D)	AVENT, INC	22/06/2021	216
525255	27/09/2022	LIBERO	3 (S/D)	Essity Hygiene and Health Aktiebolag	05/12/2021	216
525256	27/09/2022	YANMAR	7 (S/D)	Yanmar Holdings Co., Ltd.	03/12/2021	156
525259	27/09/2022	PANASONIC (mixta)	1 (S/D), 2 (S/D), 6 (S/D), 7 (S/D), 8 (S/D), 9 (S/D), 10 (S/D), 11 (S/D), 12 (S/D), 14 (S/D), 15 (S/D), 16 (S/D), 17 (S/D), 19 (S/D), 20 (S/D), 21 (S/D), 28 (S/D), 35 (S/D), 36 (S/D), 37 (S/D), 38 (S/D), 40 (S/D), 41 (S/D) y 42 (S/D)	PANASONIC CORPORATION	26/07/2021	216
525261	27/09/2022	FRESENIUS MEDICAL CARE (mixta)	5 (S/D), 10 (S/D) y 44 (S/D)	FRESENIUS MEDICAL CARE DEUTSCHLAND GMBH	09/07/2021	34
525264	27/09/2022	TECHNICS (mixta)	9 (S/D)	PANASONIC CORPORATION	26/07/2021	216
525265	27/09/2022	INNOXA	3 (S/D)	INNOXA MARKS PTY LIMITED	26/11/2021	144
525267	27/09/2022	GOODYEAR (mixta)	25	THE GOODYEAR TIRE & RUBBER COMPANY	17/09/2021	216
525268	27/09/2022	(figurativa)	25	THE GOODYEAR TIRE & RUBBER COMPANY	17/09/2021	216
525269	27/09/2022	(figurativa)	1	Sidela S.A.	28/06/2021	240
525270	27/09/2022	MAYORAL	5 (S/D)	ADAMA Agan Ltd	17/06/2021	165
525273	27/09/2022	PEDESTAL	5 (S/D)	ADAMA Makhteshim Ltd.	23/06/2021	165
525274	27/09/2022	HERSHEY'S AIR	30	THE HERSHEY COMPANY	12/12/2021	34

N° Exp	Resolución	Denominación	Clases	Titular	Vigencia	Ag.
525275	27/09/2022	KOH-I-NOOR (mixta)	16 (S/D)	ETABLISSEMENT INTERNATIONAL CRAYOMINE	03/12/2021	34
525278	27/09/2022	FUJIWARA	25 (S/D)	BSB PARTICIPAÇÕES S.A.	23/08/2021	34
525279	27/09/2022	GRAN TURISMO	9 (S/D)	SONY INTERACTIVE ENTERTAINMENT INC.	02/12/2021	216
525281	27/09/2022	POLYPHONY DIGITAL (mixta)	9 (S/D)	SONY INTERACTIVE ENTERTAINMENT INC.	02/12/2021	216
525285	27/09/2022	KESBUN	30	PEPSICO DE ARGENTINA S.R.L.	20/06/2021	201
525286	27/09/2022	BOURSIN (mixta)	29 (S/D)	BEL	27/06/2021	201
525287	27/09/2022	LEMAC (mixta)	42	Lemac Ltda.	12/06/2021	101
525291	27/09/2022	TAGWOOD (mixta)	6 y 9	FITTIPALDI ROCHA, LUCÍA FIORELLA	20/06/2021	189
525295	27/09/2022	MTN DEW (mixta)	32 (S/D)	PEPSICO, INC. UNA CORPORACIÓN DEL ESTADO DE CAROLINA DEL NORTE	21/06/2021	201
525296	27/09/2022	MTN DEW (mixta)	32 (S/D)	PEPSICO, INC. UNA CORPORACIÓN DEL ESTADO DE CAROLINA DEL NORTE	21/06/2021	201
525297	27/09/2022	TOLAS (mixta)	16, 28, 29 y 30	PEPSICO, INC.	22/06/2021	201
525298	27/09/2022	CHEETOS PELOTAZO	30	PEPSICO, INC.	22/06/2021	201
525299	27/09/2022	QUAKER, MAS AVENA, MAS VIDA	30 (S/D)	THE QUAKER OATS COMPANY	05/07/2021	201
525301	27/09/2022	CON GATORADE LLEGAS + LEJOS (mixta)	32 (S/D)	STOKELY-VAN CAMP, INC.	05/07/2021	201
525302	27/09/2022	GYNOTRAN	5 (S/D)	EXELTIS PHARMACEUTICALS HOLDING, S.L.	19/11/2021	201
525308	27/09/2022	AXA (mixta)	38 (S/D)	AXA	25/06/2021	34

RESOLUCIONES DE RENOVACIONES DE FRASES PUBLICITARIAS, CONCEDIDAS

N° Exp	Resolución	Denominación	Clases	Titular	Vigencia	Ag.
495615	13/09/2022	NADA FUNCIONA MEJOR	32 (S/D)	STOKELY-VAN CAMP, INC.	16/06/2018	201

N° Exp	Resolución	Denominación	Clases	Titular	Vigencia	Ag.
522731	06/09/2022	UN MUNDO APARTE	39	HOTEL NIRVANA S.A.	29/07/2021	179
522776	06/09/2022	UN MUNDO APARTE	35	RALDIR S.A.	26/04/2021	220
522782	06/09/2022	LA YERBA DE TODOS	30 (S/D)	INDUSTRIAS ALIMENTICIAS DEL PLATA S.A.	30/03/2021	154
523560	02/09/2022	VESTAL	3	DI CARLO S.R.L.	25/10/2021	144
523567	02/09/2022	CELGENE COMMITTED TO IMPROVING THE LIVES OF PATIENTS WORLDWIDE	42 (S/D)	CELGENE CORPORATION	22/02/2021	245

TRANSFERENCIAS

N° Exp.	Resolución	Denominación	Clases	Titular	Dirección	Ag.
379646	13/09/2022	BEEFY-T	25	HBI Branded Apparel Enterprises,LLC	1000 East Hanes Mill Road, 27105, Winston Salem, North Carolina, E. U. DE NORTEAMERICA	136
390236	21/09/2022	FORTIS	14	Fortis Watches AG	Lindenstrasse 45, 2540, Greenchen, SUIZA	192
399283	12/09/2022	VOGUE PLATINE	34	AMERICAN-CIGARETTE COMPANY (OVERSEAS) LIMITED	Route de France 17, 2926, Boncourt, SUIZA	194
399651	12/09/2022	INTRIGANTE	34	AMERICAN-CIGARETTE COMPANY (OVERSEAS) LIMITED	Route de France 17, 2926, Boncourt, SUIZA	194
403888	01/09/2022	RESERVA DEL ABAD	33	TRONEM S.A	Costa Rica 1634, Montevideo, URUGUAY	181
404254	12/09/2022	VOGUE FRISSON	34	AMERICAN-CIGARETTE COMPANY (OVERSEAS) LIMITED	Route De France 17, 2926, Boncourt, Boncourt, SUIZA	194
405510	05/09/2022	CLUB DEL LAGO HOTEL	43 y 44	Club del Lago S.A.D.	Ruta Gral Liber Seregni Km	181

N° Exp.	Resolución	Denominación	Clases	Titular	Dirección	Ag.
					116.500, Punta del Este, Maldonado, URUGUAY	
405511	05/09/2022	HOTEL DEL LAGO	43 y 44	Club del Lago S.A.D.	Ruta Gral Liber Seregni Km 116.500, Punta del Este, Maldonado, URUGUAY	181
410724	29/09/2022	CEGELEC	7, 9, 11 y 12	VINCI ENERGIES (société anonyme)	280, rue du 8 mai 1945, 78360, Montesson, FRANCIA	219
412045	23/09/2022	R DUCK	16 y 17	SHURTAPE TECHNOLOGIES, LLC.	1712 Eighth Street Drive SE Hickory, 28602, North Carolina, E. U. DE NORTEAMERICA	19
413628	15/09/2022	CARNIVERY	35 y 39	FEDERICO DI BELLO BAROFFIO	PEDRO F. BERRO 1372 Bis, Montevideo, URUGUAY	201
417839	08/09/2022	LA DOMÉNICA	30	CAROLINA PARADISO MANENTE y MIGUEL ANGEL PARAISO MANENTE	Gestido número 2490, MONTEVIDEO, URUGUAY y LIBERTAD 2919, MONTEVIDEO, URUGUAY	
419471	01/09/2022	DIMACORT	5	BALIARDA S.A.	COCHABAMBA 2525, C1252AAO, BUENOS AIRES, CAPITAL FEDERAL , ARGENTINA	201
419473	01/09/2022	DIVALSAR	5	BALIARDA S.A.	COCHABAMBA 2525, C1252AAO, BUENOS AIRES, CAPITAL FEDERAL , ARGENTINA	201
420915	05/09/2022	XEDEPAX	5	BALIARDA S.A.	COCHABAMBA 2525, C1252AAO , BUENOS AIRES, CAPITAL FEDERAL , ARGENTINA	201
420916	05/09/2022	XEDEPRAZOL	5	BALIARDA S.A.	COCHABAMBA 2525, C1252AAO , BUENOS AIRES, CAPITAL FEDERAL , ARGENTINA	201
420917	05/09/2022	XEDEPROTECT	5	BALIARDA S.A.	COCHABAMBA 2525, C1252AAO , BUENOS AIRES,	201

N° Exp.	Resolución	Denominación	Clases	Titular	Dirección	Ag.
					CAPITAL FEDERAL , ARGENTINA	
421961	23/09/2022	ISMES	9 y 42	ISMES S.P.A.	Via Lago de Tartari 3/D-3/E, Guidonia (Roma), ITALIA	194
422916	19/09/2022	UNION FILTER	7	FILTROMAX SAS	Cerro Largo 1235, Montevideo, URUGUAY	101
424138	01/09/2022	AN ORIGINAL PENGUIN BY MUNSINGWEAR	3, 9 y 18	Perry Ellis International Europe Limited	Olympic House, Pleasants Street, Dublin 8, IRLANDA	194
424691	01/09/2022	SOLEN	30	SOLEN CIKOLATA GIDA SANAYI VE TICARET ANONIM SIRKETI	4. Organize Sanayi Bölgesi 83412 No'lu Cadde No:4 çehitkamil, Gaziantep, TURQUIA	34
425163	19/09/2022	SOLOSTAR	5 y 10	SANOFI-AVENTIS DEUTSCHLAND GmbH	Brüningstrasse 50, Frankfurt am Main, ALEMANIA	165
432198	19/09/2022	TOPEX	5	DENTSPLY INTERNATIONAL INC.	221 west philadelphia street, 17405, York, PA, E. U. DE NORTEAMERICA	194
433640	01/09/2022	BISCOLATA	30	SOLEN CIKOLATA GIDA SANAYI VE TICARET ANONIM SIRKETI	4. Organize Sanayi Bölgesi 83412 No'lu Cadde No:4 çehitkamil, Gaziantep, TURQUIA	34
435780	08/09/2022	Q' BRILHO	3	Bril Cosméticos S.A.	Marginal da Via Anchieta, S/N- Km 14 Rudge Ramos, 09696- 000, São Bernardo do Campo, São Paulo, BRASIL	144
437310	29/09/2022	AVENT	10	Koninklijke Philips N.V.	High Tech Campus 5, , 5656AE , Eindhoven, PAISES BAJOS	34
437311	29/09/2022	AVENT NATURALLY	10	Koninklijke Philips N.V.	High Tech Campus 5, , 5656AE , Eindhoven, PAISES BAJOS	245
437538	20/09/2022	ARTEZ WESTERLEY	3	SANTIAGO MARIO DI NATALE y FERNANDO ARIEL PEREZ	Lavalle 310, Piso 4, Buenos Aires, ARGENTINA y Lavalle 310, Piso 4, Buenos Aires, ARGENTINA	201
438852	01/09/2022	MOSATIL	5	BALIARDA S.A.	COCHABAMBA 2525,	201

N° Exp.	Resolución	Denominación	Clases	Titular	Dirección	Ag.
					C1252AAO, BUENOS AIRES, CAPITAL FEDERAL , ARGENTINA	
439386	05/09/2022	EUTRANSIL	5	BALIARDA S.A.	COCHABAMBA 2525, C1252AAO , BUENOS AIRES, CAPITAL FEDERAL , ARGENTINA	201
439387	05/09/2022	MIOPAX	5	BALIARDA S.A.	COCHABAMBA 2525, C1252AAO , BUENOS AIRES, CAPITAL FEDERAL , ARGENTINA	201
439574	05/09/2022	VENLIFAX	5	BALIARDA S.A.	COCHABAMBA 2525, C1252AAO , BUENOS AIRES, CAPITAL FEDERAL , ARGENTINA	201
442225	01/09/2022	DOBLE CLIC	9, 35 y 41	LETICIA OGUES CARUSSO	Emilio Frugoni 1368 ap. 006, Montevideo, URUGUAY	144
443109	13/09/2022	ANNE KLEIN	14 y 25	WH BUYER, LLC	230 Park Avenue, 10169, NEW YORK, NEW YORK, E. U. DE NORTEAMERICA	212
443110	13/09/2022	ANNE KLEIN	3	WH BUYER, LLC	230 Park Avenue , 10169, NEW YORK, NEW YORK, E. U. DE NORTEAMERICA	212
447652	01/09/2022	JINGLE	30	SOLENIKOLATA GIDA SANAYI VE TICARET ANONIM SIRKETI	4. Organize Sanayi Bölgesi 83412 No'lu Cadde No:4 Çehitkamil, Gaziantep, TURQUIA	34
451473	29/09/2022	INVISTA	22, 23, 24, 25 y 27	INVISTA TEXTILES (U.K.)Ltd.	One St. Peter´s Square, M2 3DE, Manchester, United Kingdom	194
451921	22/09/2022	AXION ENERGY AXION	4, 35, 37 y 39	PAN AMERICAN ENERGY GROUP, S.L.	Arbea Campus Empresarial, Edificio Número 1, Carretera de Fuencarral a Alcobendas, M-603, 3.8 Km, 28108, ALCOBENDAS, MADRID, ESPAÑA	94

N° Exp.	Resolución	Denominación	Clases	Titular	Dirección	Ag.
452691	23/09/2022	THE FIRM OF GLOBAL CITIZENS	35, 36, 42 y 45	Henley & Partners Group HoldingsLtd.	Pendergardens Business Tower, Level 2, Saint Andrews Road, STJ 9023, St Julian's, Paceville, MALTA	219
453693	01/09/2022	AN ORIGINAL PENGUIN BY MUNSINGWEAR	35	Perry Ellis International Europe Limited	Olympic House, Pleasants Street, Dublin 8, IRLANDA	194
461935	15/09/2022	KAMI KAIMI	3	SHANGHAI KAIMI TECHNOLOGY CO., LTD.	2S88 XUPAN ROAD, XUHANG TOWN, JIADING DISTRICT, SHANGHAI, SUIZA	201
465829	30/09/2022	PSYCHO BUNNY	25	Psycho Bunny Inc.	5001-5003 rue Levy/5001-5003 Levy Street, H4R2N9, St. Laurent, Quebec, CANADA	194
465829	29/09/2022	PSYCHO BUNNY	25	Psycho Bunny Inc.	5001-5003 rue Levy/5001-5003 Levy Street, H4R2N9, St. Laurent, Quebec, CANADA	194
465830	30/09/2022		25	Psycho Bunny Inc.	5001-5003 Levy Street, H4R2N9, St. Laurent, Quebec, CANADA	194
469272	02/09/2022	M MUNSINGWEAR	25	Perry Ellis International Europe Limited	Olympic House, Pleasants, Dublin 8 , IRLANDA	194
472841	26/09/2022	SOLARIS	9	GrandVision Retail Holding B.V.	Evert van de Beekstraat 1-80, Tower C, 6th floor, Schiphol, CL 1118, PAISES BAJOS	192
473044	08/09/2022	CRANE	7	CRANE HOLDINGS, CO.	100 First Stamford Place, 06902, Stamford, Connecticut, E. U. DE NORTEAMERICA	144
475223	09/09/2022	LAPRENE	1 y 17	Celanese International Corporation	222 W.las Colinas Blvd, Suite 900N , 75039, IRVING, TEXAS, E. U. DE NORTEAMERICA	34
476939	02/09/2022	MUNSING WEAR	25	Perry Ellis International Europe Limited	Olympic House, Pleasants Street, Dublin 8, Irlanda, IRLANDA	194
483288	02/09/2022	DOS CABALLOS	29 y 30	NUEVA CURIMON SPA	Cerro El Plomo N° 5420, Oficina	245

N° Exp.	Resolución	Denominación	Clases	Titular	Dirección	Ag.
					903, Comuna de las Condes, Santiago de Chile, CHILE	
483456	05/09/2022	VIX	35, 41 y 42	Univision Digital IP Holdings, LLC	5599 Center Drive, Los Angeles, California, E. U. DE NORTEAMERICA	194
488364	02/09/2022	ORIGINAL PENGUIN MUNSINGWEAR	25	Perry Ellis International Europe Limited	Olympic House, Pleasants Street, Dublin 8, IRLANDA	194
488365	02/09/2022	AN ORIGINAL PENGUIN BY MUNSINGWEAR	25	Perry Ellis International Europe Limited	Olympic House, Pleasants Street, Dublin 8, IRLANDA	194
489427	26/09/2022	BABY TV	9 y 41	Twentieth Century Fox Film Corporation	10201 West Pico Boulevard, 90035, Los Angeles, CALIFORNIA, E. U. DE NORTEAMERICA	144
490357	05/09/2022	ALENATO	5	ROEMMERS S.A.I.C.F.	JOSE ENRIQUE RODO 6424, Ciudad Autónoma de Buenos Aires, ARGENTINA	212
490359	05/09/2022	COLIBACIN ICN	5	ROEMMERS S.A.I.C.F.	JOSE ENRIQUE RODO 6424, Ciudad Autónoma de Buenos Aires, ARGENTINA	212
490360	07/09/2022	FASELUT ICN	5	ROEMMERS S.A.I.C.F.	JOSE ENRIQUE RODO 6424, Ciudad Autónoma de Buenos Aires, ARGENTINA	212
490361	05/09/2022	GLY DERM	3 y 5	ROEMMERS S.A.I.C.F.	JOSE ENRIQUE RODO 6424, Ciudad Autónoma de Buenos Aires, ARGENTINA	212
490363	05/09/2022	MACROMAX ICN	5	ROEMMERS S.A.I.C.F.	JOSE ENRIQUE RODO 6424, Ciudad Autónoma de Buenos Aires, ARGENTINA	212
490364	05/09/2022	LIVERGOT ICN	5	ROEMMERS S.A.I.C.F.	JOSE ENRIQUE RODO 6424, Ciudad Autónoma de Buenos Aires, ARGENTINA	212
490365	05/09/2022	OTICAZEN ICN	5	ROEMMERS S.A.I.C.F.	JOSE ENRIQUE RODO 6424, Ciudad Autónoma de Buenos Aires, ARGENTINA	212

N° Exp.	Resolución	Denominación	Clases	Titular	Dirección	Ag.
490366	05/09/2022	OXSORALEN ICN	5	ROEMMERS S.A.I.C.F.	JOSE ENRIQUE RODO 6424, Ciudad Autónoma de Buenos Aires, ARGENTINA	212
490369	07/09/2022	PHAL ICN	5	ROEMMERS S.A.I.C.F.	JOSE ENRIQUE RODO 6424, Ciudad Autónoma de Buenos Aires, ARGENTINA	212
490370	07/09/2022	PRURIPLELEN ICN	5	ROEMMERS S.A.I.C.F.	JOSE ENRIQUE RODO 6424, Ciudad Autónoma de Buenos Aires, ARGENTINA	212
490371	07/09/2022	TIROHEXYL ICN	5	ROEMMERS S.A.I.C.F.	JOSE ENRIQUE RODO 6424, Ciudad Autónoma de Buenos Aires, ARGENTINA	212
490372	07/09/2022	VITAPELEN ICN	5	ROEMMERS S.A.I.C.F.	JOSE ENRIQUE RODO 6424, Ciudad Autónoma de Buenos Aires, ARGENTINA	212
491398	05/09/2022	LIBRAXIN	5	ROEMMERS S.A.I.C.F.	JOSE ENRIQUE RODO 6424, Ciudad Autónoma de Buenos Aires, ARGENTINA	212
493430	23/09/2022	MASTRA	32	ALPORY S.A	Rivadavia 1898, Montevideo, URUGUAY	94
495908	08/09/2022	PROPERATI	35	RESEM CLASSIFIED SPAIN, S.L.	Avenida Diagonal N° 601, Peatonal 9, BARCELONA, ESPAÑA	216
496455	16/09/2022	MLR	25, 35 y 41	MAJOR LEAGUE RUGBY, LLC	5910 N. Central Expressway, Suite 1070, 75206 , Dallas , Texas , E. U. DE NORTEAMERICA	194
496868	19/09/2022	NUVARING	5 y 10	N. V. ORGANON	Kloosterstraat 6, 5349 AB, OSS, PAISES BAJOS	201
497941	16/09/2022	MLR	25, 35 y 41	MAJOR LEAGUE RUGBY, LLC	5910 N. Central Expressway, Suite 1070, 75206 , Dallas , Texas , E. U. DE NORTEAMERICA	194
498041	29/09/2022	MAJOR LEAGUE RUGBY	25, 35 y 41	MAJOR LEAGUE	5910 N. Central Expressway,	194

N° Exp.	Resolución	Denominación	Clases	Titular	Dirección	Ag.
				RUGBY, LLC	Suite 1070, 75206, Dallas, Texas , E. U. DE NORTEAMERICA	
501958	05/09/2022	PAUSINAL	5	ROEMMERS S.A.I.C.F.	JOSE ENRIQUE RODO 6424, Ciudad Autónoma de Buenos Aires, ARGENTINA	212
503096	09/09/2022	SONIA RYKIEL	25	SONIA R. PROPERTIES SA	Chemin du Pré-Fleuri 5, 1228, Plan-les-Ouates, SUIZA	201
505819	31/08/2022	ALTIUS GROUP	9	Altius Uruguay Holding LLC	Plaza Independencia 848, Piso 1, Montevideo, URUGUAY	201
508532	13/09/2022	LI LITHIUM SOFTWARE	9 y 42	ALFATOTAL S.A.	AV. FRANCISCO SOCA 1531, MONTEVIDEO, URUGUAY	
518370	30/09/2022	DON US COMPANY	43	DON US COMPANY LLC	2330 PONCE DE LEON BLVD., 33134, CORAL GABLES, FLORIDA, E. U. DE NORTEAMERICA	144
518389	16/09/2022	SURA FONDO DE INVERSIÓN FUTURO	36	Grupo de Inversiones Suramericana S.A.	Carrera 43 A No. 5 A-113 Pisos 13, 14 y 15 Edificio One Plaza, Medellín, Antioquía, COLOMBIA	218
518390	16/09/2022	SURA FONDO DE INVERSIÓN RETIRO	36	Grupo de Inversiones Suramericana S.A.	Carrera 43 A No. 5 A-113 Pisos 13, 14 y 15 Edificio One Plaza, Medellín, Antioquía, COLOMBIA	218
519054	13/09/2022	MULTIHOGAR	35	TA-TA S.A.	Jose de Bejar 2600, 12100, MONTEVIDEO, URUGUAY	245
524523	13/09/2022	L LITHIUM SOFTWARE	9 y 42	ALFATOTAL S.A.	AV. FRANCISCO SOCA 1531, MONTEVIDEO, URUGUAY	
526432	19/09/2022	MERCILON	5	N. V. ORGANON	Kloosterstraat 6, 5349 AB, OSS, PAISES BAJOS	201
531035	16/09/2022	SURA OPORTUNIDADES GLOBALES FONDO DE INVERSIÓN	36	Grupo de Inversiones Suramericana S.A.	Carrera 43 A No. 5 A-113 Pisos 13, 14 y 15 Edificio One Plaza, Medellín, Antioquía, COLOMBIA	218
533273	19/09/2022	ARROW	3, 14 y 18	ABG IZOD LLC	1411 Broadway, 10018, New	201

N° Exp.	Resolución	Denominación	Clases	Titular	Dirección	Ag.
					York, New York, E. U. DE NORTEAMERICA	
534068	07/09/2022	SIKA	2, 6, 11, 17, 19 y 21	Sika Technology AG	Zugerstrasse 50, 6340, Baar, Baar, SUIZA	201
535232	02/09/2022	MUNSINGWEAR	25	Perry Ellis International Europe Limited	Olympic House, Pleasants Street, Dublin 8, IRLANDA	194
536164	23/09/2022	LA CAMPAGNOLA	29 y 30	ARCOR S.A.I.C.	Maipu 1210, piso 1° y 2°, Buenos Aires, ARGENTINA	154
536847	07/09/2022	SIKA	1 y 19	Sika Technology AG	Zugerstrasse 50, 6340, Baar, Baar, SUIZA	201

TRANSFERENCIAS DESESTIMADAS (Art. 92, D. 34/999)

N° Exp.	Resolución	Denominación	Clases	Titular	Dirección	Ag.
520665	27/09/2022	NERO53 FERNET PREMIUM	33 y 43	Juan Ignacio Soria y Gaston Soria	Irigoitia 1149. Casa 013, Montevideo, Montevideo, Montevideo, URUGUAY y Irigoitia 1149 Casa 013, Montevideo, Montevideo, Montevideo, URUGUAY	172

TRANSFERENCIAS DE PATENTES

N° Exp.	Resolución	Titular	Dirección	Ag.
034307	20/09/2022	Vrio Corp.		218
034567	29/09/2022	Vrio Corp.		218
034695	22/09/2022	Boehringer Ingelheim Animal Health USA Inc. y FREIE UNIVERSITÄT BERLIN		94
036648	20/09/2022	VIIV HEALTHCARE UK (NO.5) LIMITED		192
036649	20/09/2022	VIIV HEALTHCARE UK (No. 5) LIMITED		192
036650	20/09/2022	VIIV HEALTHCARE UK (No. 5) LIMITED		192
036810	28/09/2022	AirScout International, Inc.		211
036810	27/09/2022	AirScout International, Inc.		211

CAMBIOS DE NOMBRE

N° Exp.	Resolución	Denominación	Clases	Titular	Dirección	Ag.
390236	15/09/2022	FORTIS	14	Fortis Watches AG	Lindenstrasse 45, 2540, Greenchen, SUIZA	192
394134	29/09/2022	CAMPOFRIO	29	CAMPOFRIO FOOD GROUP S.A.U.	Parque Empresarial La Moraleja / Avenida de Europa 24, 28109, Alcobendas, Madrid, ESPAÑA	154
395907	19/09/2022	ANCHOR	21	ANCHOR HEALTH AND BEAUTY CARE PVT. LTD.	Marathon Nextgen, 'Innova' 201, 'C' Wing, 400 013, Mumbai, INDIA	181
397411	27/09/2022	D' AUCY	29	D'AUCY FRANCE	Kerlurec-Sain Leonard Nort, 56450, Theix, FRANCIA	245
397600	07/09/2022		41, 44 y 45	CRAME IAMPP	Avda. Roosevelt y Joaquin de Viana, Maldonado, URUGUAY	101
397935	19/09/2022	MIRADOR	5	ADAMA Celsius B.V.	Pos Cabai Office Park Unit 13, Curaçao, ANTILLAS NEERLANDESAS	144
400413	09/09/2022	APRECIN	5	Galderma Holding S.A.	Zählerweg 10 , 6300, ZUG, SUIZA	245
400413	07/09/2022	APRECIN	5	Galderma Holding S.A.	Zählerweg 10 , 6300, ZUG, SUIZA	245
405964	16/09/2022	RESTORADERM	3, 5 y 10	Galderma Holding S.A.	Zählerweg 10, 6300, ZUG, SUIZA	245
405964	15/09/2022	RESTORADERM	3, 5 y 10	Galderma Holding S.A.	Zählerweg 10, 6300, ZUG, SUIZA	245
407506	22/09/2022	DERMOTIVIN	3 y 5	Galderma Holding S.A.	Zählerweg 10, 6300, ZUG, SUIZA	245
407506	07/09/2022	DERMOTIVIN	3 y 5	Galderma Holding S.A.	Zählerweg 10, 6300, ZUG, SUIZA	245
410130	12/09/2022	NEW BALANCE	18 y 25	NEW BALANCE ATHLETICS, INC.	100 Guest Street , 02135, Boston, Massachusetts, E. U. DE NORTEAMERICA	21
410724	22/09/2022	CEGELEC	7, 9, 11 y 12	VINCI ENERGIES (société anonyme)	280, rue du 8 mai 1945, 78360, Montesson, FRANCIA	219

N° Exp.	Resolución	Denominación	Clases	Titular	Dirección	Ag.
416717	14/09/2022	EMERVEL	3, 5 y 10	Galderma Holding S.A.	Zählerweg 10, 6300, ZUG, SUIZA	245
416717	13/09/2022	EMERVEL	3, 5 y 10	Galderma Holding S.A.	Zählerweg 10, 6300, ZUG, SUIZA	245
418010	01/09/2022	ROCA MOBILE	9	MANCRU S.A.	PAYSANDU 1175, Montevideo, URUGUAY	201
418654	01/09/2022	COSEM MUTUALISTA SEMM	44	COSEM IAMPP.	Br. Artigas 1305, Montevideo, Montevideo, URUGUAY	101
419574	22/09/2022	CURELIGHT	10	Galderma Holding S.A.	Zählerweg 10, 6300, ZUG, SUIZA	245
419574	09/09/2022	CURELIGHT	10	Galderma Holding S.A.	Zählerweg 10, 6300, ZUG, SUIZA	245
419575	23/09/2022	METVIX	5	Galderma Holding S.A.	Zählerweg 10, 6300, ZUG, SUIZA	245
419575	12/09/2022	METVIX	5	Galderma Holding S.A.	Zählerweg 10, 6300, ZUG, SUIZA	245
419577	09/09/2022	CEDUANCE	3, 5 y 10	Galderma Holding S.A.	Zählerweg 10, 6300, ZUG, SUIZA	245
419577	20/09/2022	CEDUANCE	3, 5 y 10	Galderma Holding S.A.	Zählerweg 10, 6300, ZUG, SUIZA	245
419579	20/09/2022	AKTILITE	10	Galderma Holding S.A.	Zählerweg 10, 6300, ZUG, SUIZA	245
419579	07/09/2022	AKTILITE	10	Galderma Holding S.A.	Zählerweg 10, 6300, ZUG, SUIZA	245
420403	12/09/2022	MILESTONE	35	ACTIVIST ADMINISTRAÇÃO DE BENS PRÓPRIOS LTDA.	RUA TABAPUÃ, N° 145, SALA 36, ITAIM BIBI, SÃO PAULO , SP, BRASIL	34
420483	05/09/2022	VISUAR	1, 9, 11, 35 y 39	VISUAR S.A.	B. Quinquela Martin 1924, Buenos Aires, Buenos Aires, ARGENTINA	34
420820	08/09/2022	CREVAGIN	5	EUROFARMA URUGUAY S.A.	Democracia 2132, Montevideo, Montevideo, URUGUAY	201
420820	05/09/2022	CREVAGIN	5	EUROFARMA	Democracia 2132, Montevideo,	201

N° Exp.	Resolución	Denominación	Clases	Titular	Dirección	Ag.
				URUGUAY S.A.	Montevideo, URUGUAY	
421819	23/09/2022	SADIA RIKITOS	29	BRF Singapore Foods PTE Limited.	8, Marina Boulevard, #05-02, 018981, Marina Bay , Financial Centre, SINGAPUR	94
421998	28/09/2022	TRI-LUMA	5	Galderma Holding S.A.	Zählerweg 10, 6300, ZUG, SUIZA	245
421998	15/09/2022	TRI-LUMA	5	Galderma Holding S.A.	Zählerweg 10, 6300, ZUG, SUIZA	245
422567	05/09/2022	JEAN PAUL GAULTIER CLASSIQUE	3	PUIG FRANCE	65-67 avenue des Champs-Elysées, 75008 , Paris, FRANCIA	144
423044	12/09/2022	SISLEY	25	BENETTON GROUP S.R.L	Villa Minelli 1, 31050, Ponzano Veneto TV, ITALIA	245
423910	01/09/2022	DCR	1, 16 y 17	Denka Company Limited	1-1, Nihonbashi-Muromachi 2-chome, Chuo-ku, Tokyo, JAPON	216
423914	08/09/2022	POWERBAR	5 y 32	PREMIER NUTRITION COMPANY, LLC	94608, CALIFORNIA, E. U. DE NORTEAMERICA	156
424209	05/09/2022	COSTA URBANA	16, 35, 36, 37, 41, 42 y 43	Costa Urbana S.A.	Avenida Giannattasio Km 21, Administración Costa Urbana Shopping, Ciudad de la Costa, Canelones, URUGUAY	144
426173	12/09/2022	RÖHLIG	39	Röhlig Logistics GmbH & Co. KG	AVENUE GRATTA-PAILLE 2, LAUSANNE, 1018, LAUSANNE, LAUSANNE, SUIZA	194
427245	26/09/2022	STARBUCKS VERANDA BLEND	30	STARBUCKS CORPORATION	2401 UTAH AVENUE SOUTH, SEATTLE , WASHINGTON, E. U. DE NORTEAMERICA	212
427662	23/09/2022	SOFINNOVA	36	Sofinnova Investments, Inc.	3000 Sand Hill Rd., Bldg. 4, Suite 250, 94025, Menlo Park, California , E. U. DE NORTEAMERICA	201
428960	28/09/2022	VASTREKA	5	Galderma Holding S.A.	Zählerweg 10, 6300, ZUG, SUIZA	245

N° Exp.	Resolución	Denominación	Clases	Titular	Dirección	Ag.
428960	15/09/2022	VASTREKA	5	Galderma Holding S.A.	Zählerweg 10, 6300, ZUG, SUIZA	245
428961	23/09/2022	MIRVASO	5	Galderma Holding S.A.	Zählerweg 10, 6300, ZUG, SUIZA	245
428961	12/09/2022	MIRVASO	5	Galderma Holding S.A.	Zählerweg 10, 6300, ZUG, SUIZA	245
429018	20/09/2022	ONREALTEA	5	Galderma Holding S.A.	Zählerweg 10, 6300, ZUG, SUIZA	245
429018	26/09/2022	ONREALTEA	5	Galderma Holding S.A.	Zählerweg 10, 6300, ZUG, SUIZA	245
429022	08/09/2022	ELVAYA	5	Galderma Holding S.A.	Zählerweg 10, 6300, ZUG, SUIZA	245
429022	22/09/2022	ELVAYA	5	Galderma Holding S.A.	Zählerweg 10, 6300, ZUG, SUIZA	245
429023	27/09/2022	SELSTREKA	5	Galderma Holding S.A.	Zählerweg 10, 6300, ZUG, SUIZA	245
429023	13/09/2022	SELSTREKA	5	Galderma Holding S.A.	Zählerweg 10, 6300, ZUG, SUIZA	245
429684	26/09/2022	ONRELTEA	5	Galderma Holding S.A.	Zählerweg 10, 6300, ZUG, SUIZA	245
429684	12/09/2022	ONRELTEA	5	Galderma Holding S.A.	Zählerweg 10, 6300, ZUG, SUIZA	245
430416	22/09/2022	ERYACNE	5	Galderma Holding S.A.	Zählerweg 10, 6300, ZUG, SUIZA	245
430416	08/09/2022	ERYACNE	5	Galderma Holding S.A.	Zählerweg 10, 6300, ZUG, SUIZA	245
430417	08/09/2022	DIFFERINE	5	Galderma Holding S.A.	Zählerweg 10, 6300, ZUG, SUIZA	245
430417	22/09/2022	DIFFERINE	5	Galderma Holding S.A.	Zählerweg 10, 6300, ZUG, SUIZA	245
430529	13/09/2022	TALIXANE	5	Galderma Holding S.A.	Zählerweg 10, 6300, ZUG, SUIZA	245
430529	28/09/2022	TALIXANE	5	Galderma Holding S.A.	Zählerweg 10, 6300, ZUG, SUIZA	245

N° Exp.	Resolución	Denominación	Clases	Titular	Dirección	Ag.
430639	20/09/2022	PROVIRTUA	35	Galderma Holding S.A.	Zählerweg 10, 6300, ZUG, SUIZA	245
430639	26/09/2022	PROVIRTUA	35	Galderma Holding S.A.	Zählerweg 10, 6300, ZUG, SUIZA	245
432781	01/09/2022	INMUSAFE	5	RINQUE PHARMA S.A.	SANLUCAR 1545, MONTEVIDEO, URUGUAY	34
432782	01/09/2022	INMUGRAF	5	RINQUE PHARMA S.A.	SANLUCAR 1545, MONTEVIDEO, URUGUAY	34
436095	23/09/2022	INNEOV	3, 5, 29 y 30	Galderma Holding S.A.	Zählerweg 10, 6300, ZUG, SUIZA	245
436095	08/09/2022	INNEOV	3, 5, 29 y 30	Galderma Holding S.A.	Zählerweg 10, 6300, ZUG, SUIZA	245
437476	13/09/2022	RETACNYL	5	Galderma Holding S.A.	Zählerweg 10, 6300, ZUG, SUIZA	245
437476	27/09/2022	RETACNYL	5	Galderma Holding S.A.	Zählerweg 10, 6300, ZUG, SUIZA	245
437477	26/09/2022	OPALEX	5	Galderma Skin Health S.A.	Avenue Gratta-Paille 2, 1018, Lausanne, SUIZA	245
437493	05/09/2022	AMITIE	5	EUROFARMA URUGUAY S.A.	Democracia 2132, Montevideo, URUGUAY	201
437610	09/09/2022	UNHEX	3 y 8	MEREJE BRAZIL INDUSTRIA DE METALURGIA DE PRECISAO LTDA.	ALAMEDA CAIAPÓS 278, 04060-110, BARUERI, SAN PABLO, BRASIL	201
438003	05/09/2022	CHAMPION	31	PROA S.A.	Exposición # 1511, Comuna de Estación Central, Santiago, CHILE	194
438203	20/09/2022	BALENCIAGA	3, 9, 14, 18, 21, 24, 25 y 26	BALENCIAGA	40 rue de Sèvres, Paris, 75007, Paris, FRANCIA	194
438228	20/09/2022	A Q-MED ALLIANCE	38, 41 y 44	Galderma Holding S.A.	Zählerweg 10, 6300, ZUG, SUIZA	245
438228	07/09/2022	A Q-MED ALLIANCE	38, 41 y 44	Galderma Holding S.A.	Zählerweg 10, 6300, ZUG, SUIZA	245
438257	13/09/2022	APITOX	5	APITOX S.A.	MERCEDES 1245, Montevideo,	105

N° Exp.	Resolución	Denominación	Clases	Titular	Dirección	Ag.
					Montevideo, URUGUAY	
438329	01/09/2022	CO.ME.SA COOPERATIVA MEDICA DE SAN JOSE	44	ASOCIACION MEDICA DE SAN JOSE IAMPP	Becerro de Bengoa 462, San José, San José, URUGUAY	201
438561	07/09/2022	AQUACLIN	3	Galderma Holding S.A.	Zählerweg 10, 6300, ZUG, SUIZA	245
438561	20/09/2022	AQUACLIN	3	Galderma Holding S.A.	Zählerweg 10, 6300, ZUG, SUIZA	245
438562	23/09/2022	LATINADERM EXCELLENCE	41	Galderma Holding S.A.	Zählerweg 10, 6300, ZUG, SUIZA	245
438562	09/09/2022	LATINADERM EXCELLENCE	41	Galderma Holding S.A.	Zählerweg 10, 6300, ZUG, SUIZA	245
438679	07/09/2022	BENZAC	3	Galderma Holding S.A.	Zählerweg 10, 6300, ZUG, SUIZA	245
438679	20/09/2022	BENZAC	3	Galderma Holding S.A.	Zählerweg 10, 6300, ZUG, SUIZA	245
439706	26/09/2022	A ATLAS	28	EPICUS S.A.	AREQUITA 2282 BIS, Montevideo, Montevideo, URUGUAY	220
441764	09/09/2022	BENZIHEX	5	Galderma Holding S.A.	Zählerweg 10, 6300, ZUG, SUIZA	245
441764	20/09/2022	BENZIHEX	5	Galderma Holding S.A.	Zählerweg 10, 6300, ZUG, SUIZA	245
441767	28/09/2022	SILCOR	5	Galderma Holding S.A.	Zählerweg 10, 6300, ZUG, SUIZA	245
441767	13/09/2022	SILCOR	5	Galderma Holding S.A.	Zählerweg 10, 6300, ZUG, SUIZA	245
442478	07/09/2022	VITO	12	Mercedes-Benz Group AG.	Mercedesstraße 120, 70372 , Stuttgart, ALEMANIA	34
443051	13/09/2022	RESTYLANE	3 y 10	Galderma Holding S.A.	Zählerweg 10, 6300, ZUG, SUIZA	245
443051	27/09/2022	RESTYLANE	3 y 10	Galderma Holding S.A.	Zählerweg 10, 6300, ZUG, SUIZA	245
443323	13/09/2022	SOOLANTRA	3 y 5	Galderma Holding S.A.	Zählerweg 10, 6300, ZUG, SUIZA	245

N° Exp.	Resolución	Denominación	Clases	Titular	Dirección	Ag.
443323	28/09/2022	SOOLANTRA	3 y 5	Galderma Holding S.A.	Zählerweg 10, 6300, ZUG, SUIZA	245
445013	02/09/2022		36	Rothschild & Co Continuation Holdings AG	Baarerstrasse 95, 6300, Zug, SUIZA	194
446196	07/09/2022	AFONGAN	5	Galderma Holding S.A.	Zählerweg 10, 6300, ZUG, SUIZA	245
446196	20/09/2022	AFONGAN	5	Galderma Holding S.A.	Zählerweg 10, 6300, ZUG, SUIZA	245
446247	22/09/2022	GALDERMA	3, 5 y 10	Galderma Holding S.A.	Zählerweg 10, 6300, ZUG, SUIZA	245
446247	08/09/2022	GALDERMA	3, 5 y 10	Galderma Holding S.A.	Zählerweg 10, 6300, ZUG, SUIZA	245
447194	23/09/2022	GALDERMA	3 y 5	Galderma Holding S.A.	Zählerweg 10, 6300, ZUG, SUIZA	245
447194	08/09/2022	GALDERMA	3 y 5	Galderma Holding S.A.	Zählerweg 10, 6300, ZUG, SUIZA	245
447459	20/09/2022	ACTINICA	3	Galderma Holding S.A.	Zählerweg 10, 6300, ZUG, SUIZA	245
447556	22/09/2022	ELVALY	5	Galderma Holding S.A.	Zählerweg 10, 6300, ZUG, SUIZA	245
447556	08/09/2022	ELVALY	5	Galderma Holding S.A.	Zählerweg 10, 6300, ZUG, SUIZA	245
448027	07/09/2022	AQUACLIN	3	Galderma Holding S.A.	Zählerweg 10, 6300, ZUG, SUIZA	245
448027	20/09/2022	AQUACLIN	3	Galderma Holding S.A.	Zählerweg 10, 6300, ZUG, SUIZA	245
448249	07/09/2022	BENZAKARE	3 y 10	Galderma Holding S.A.	Zählerweg 10, 6300, ZUG, SUIZA	245
448249	20/09/2022	BENZAKARE	3 y 10	Galderma Holding S.A.	Zählerweg 10, 6300, ZUG, SUIZA	245
449823	30/09/2022	OUTSIDE	16 y 38	MARIAH MEDIA, LLC	400 Market Street, 87501, Santa Fe, New Mexico, E. U. DE NORTEAMERICA	136

N° Exp.	Resolución	Denominación	Clases	Titular	Dirección	Ag.
451781	05/09/2022	JEAN PAUL GAULTIER	3, 18 y 25	PUIG FRANCE	65-67 avenue des Champs-Elysées , 75008, Paris, FRANCIA	144
454329	20/09/2022	CETAPHIL	3	Galderma Holding S.A.	Zählerweg 10, 6300, ZUG, SUIZA	245
454329	09/09/2022	CETAPHIL	3	Galderma Holding S.A.	Zählerweg 10, 6300, ZUG, SUIZA	245
454590	23/09/2022	LOCYCARE	3	Galderma Holding S.A.	Zählerweg 10, 6300, ZUG, SUIZA	245
454590	12/09/2022	LOCYCARE	3	Galderma Holding S.A.	Zählerweg 10, 6300, ZUG, SUIZA	245
454847	02/09/2022	FIVE ARROWS	36	Rothschild & Co Continuation Holdings AG	Baarerstrasse 95, 6300, Zug, SUIZA	194
454848	02/09/2022		36	Rothschild & Co Continuation Holdings AG	Baarerstrasse 95, 6300, Zug, SUIZA	194
455513	20/09/2022	ACLINA	5	Galderma Holding S.A.	Zählerweg 10, 6300, ZUG, SUIZA	245
455513	07/09/2022	ACLINA	5	Galderma Holding S.A.	Zählerweg 10, 6300, ZUG, SUIZA	245
455516	09/09/2022	IONAX	3	Galderma Holding S.A.	Zählerweg 10, 6300, ZUG, SUIZA	245
455516	23/09/2022	IONAX	3	Galderma Holding S.A.	Zählerweg 10, 6300, ZUG, SUIZA	245
458116	12/09/2022	NUTRAPLUS	3	Galderma Holding S.A.	Zählerweg 10, 6300, ZUG, SUIZA	245
458116	27/09/2022	NUTRAPLUS	3	Galderma Holding S.A.	Zählerweg 10, 6300, ZUG, SUIZA	245
459040	26/09/2022	NUTRAPLUS	5	Galderma Holding S.A.	Zählerweg 10, 6300, ZUG, SUIZA	245
459040	20/09/2022	NUTRAPLUS	5	Galderma Holding S.A.	Zählerweg 10, 6300, ZUG, SUIZA	245
461375	26/09/2022	ONYMAX	5	Galderma Holding S.A.	Zählerweg 10, 6300, ZUG, SUIZA	245

N° Exp.	Resolución	Denominación	Clases	Titular	Dirección	Ag.
					SUIZA	
461375	27/09/2022	ONYMAX	5	Galderma Holding S.A.	Zählerweg 10, 6300, ZUG, SUIZA	245
461544	02/09/2022		7 y 12	CNH Industrial Italia S.p.A	Via Plava 80, 10135, Turino, ITALIA	144
463846	07/09/2022	TENESLUGAR	9, 36 y 39	Mercedes-Benz Group AG.	Mercedesstraße 120, 70372 , Stuttgart, ALEMANIA	34
464078	08/09/2022	MERCEDES	7 y 12	Mercedes-Benz Group AG.	Mercedesstraße 120, 70372 , Stuttgart, ALEMANIA	34
464233	23/09/2022	LOCERYL	5	Galderma Holding S.A.	Zählerweg 10, 6300, ZUG, SUIZA	245
464233	12/09/2022	LOCERYL	5	Galderma Holding S.A.	Zählerweg 10, 6300, ZUG, SUIZA	245
464234	27/09/2022	SANSACNE	5	Galderma Holding S.A.	Zählerweg 10, 6300, ZUG, SUIZA	245
464234	13/09/2022	SANSACNE	5	Galderma Holding S.A.	Zählerweg 10, 6300, ZUG, SUIZA	245
465118	08/09/2022	GALDERMA	3, 5 y 10	Galderma Holding S.A.	Zählerweg 10, 6300, ZUG, SUIZA	245
465118	23/09/2022	GALDERMA	3, 5 y 10	Galderma Holding S.A.	Zählerweg 10, 6300, ZUG, SUIZA	245
466472	20/09/2022	SCULPTRA	3, 5 y 10	Galderma Holding S.A.	Zählerweg 10, 6300, ZUG, SUIZA	245
466472	27/09/2022	SCULPTRA	3, 5 y 10	Galderma Holding S.A.	Zählerweg 10, 6300, ZUG, SUIZA	245
467023	02/09/2022	ROTHSCHILD & CO	36	Rothschild & Co Continuation Holdings AG	Baarerstrasse 95, 6300, Zug, SUIZA	194
471337	09/09/2022	DESOWEN	5	Galderma Holding S.A.	Zählerweg 10, 6300, ZUG, SUIZA	245
471337	22/09/2022	DESOWEN	5	Galderma Holding S.A.	Zählerweg 10, 6300, ZUG, SUIZA	245
471405	07/09/2022	MERCEDES BENZ	4, 6, 7, 8, 9, 11 y 12	Mercedes-Benz Group AG.	Mercedesstraße 120, 70372 , Stuttgart, ALEMANIA	34

N° Exp.	Resolución	Denominación	Clases	Titular	Dirección	Ag.
471406	07/09/2022		4, 6, 7, 8, 9, 11 y 12	Mercedes-Benz Group AG.	Mercedesstraße 120, 70372 , Stuttgart, ALEMANIA	34
473299	12/09/2022	NUTRADERM	3, 10 y 44	Galderma Holding S.A.	Zählerweg 10, 6300, ZUG, SUIZA	245
473299	23/09/2022	NUTRADERM	3, 10 y 44	Galderma Holding S.A.	Zählerweg 10, 6300, ZUG, SUIZA	245
475403	20/09/2022	CLOB-X	5	Galderma Holding S.A.	Zählerweg 10, 6300, ZUG, SUIZA	245
475403	09/09/2022	CLOB-X	5	Galderma Holding S.A.	Zählerweg 10, 6300, ZUG, SUIZA	245
475404	20/09/2022	CETAPHIL	5	Galderma Holding S.A.	Zählerweg 10, 6300, ZUG, SUIZA	245
475404	09/09/2022	CETAPHIL	5	Galderma Holding S.A.	Zählerweg 10, 6300, ZUG, SUIZA	245
476448	02/09/2022		36	Rothschild & Co Continuation Holdings AG	Baarerstrasse 95, 6300, Zug, SUIZA	194
476449	02/09/2022		36	Rothschild & Co Continuation Holdings AG	Baarerstrasse 95, 6300, Zug, SUIZA	194
478834	01/09/2022	UNIVERSITAS XXI	9	UNIVERSITAS XX, Soluciones y Tecnología para la Universidad, S.A.	C/Arequipa, 1 Bloque 1, Planta 5, 28043, Madrid , ESPAÑA	201
480086	28/09/2022	SILKIS	5	Galderma Holding S.A.	Zählerweg 10, 6300, ZUG, SUIZA	245
480086	13/09/2022	SILKIS	5	Galderma Holding S.A.	Zählerweg 10, 6300, ZUG, SUIZA	245
480599	01/09/2022	CROMARGAN	8 y 11	WMF GmbH	WMF Platz 1, 73312, Geislingen an der Steige , ALEMANIA	144
482249	13/09/2022	ROZEX	5	Galderma Holding S.A.	Zählerweg 10, 6300, ZUG, SUIZA	245
482249	27/09/2022	ROZEX	5	Galderma Holding S.A.	Zählerweg 10, 6300, ZUG, SUIZA	245
482562	07/09/2022	BENZAC	5	Galderma Holding S.A..	Zählerweg 10 , 6300, ZUG,	245

N° Exp.	Resolución	Denominación	Clases	Titular	Dirección	Ag.
					SUIZA	
482562	16/09/2022	BENZAC	5	Galderma Holding S.A..	Zählerweg 10 , 6300, ZUG, SUIZA	245
484379	22/09/2022	HYDRAFACIAL	3, 10 y 44	HydraFacial LLC	2165 E. Spring Street Long Beach, 90806, California, E. U. DE NORTEAMERICA	245
488226	28/09/2022	STARLIMS	9 y 42	STARLIMS Corporation	4000 Hollywood Blvd. Suite 333-S, 33021, Hollywood, Florida, E. U. DE NORTEAMERICA	136
491287	08/09/2022	ALMO NATURE OWNED BY THE ANIMALS	5 y 31	Almo Nature Benefit S.p.A	Piazza Dei Giustiniani, 6, 16123, Genova, Genova, ITALIA	144
492294	01/06/2022	DIRECTV SPORTS	9, 38, 41 y 42	THE AT&T MVPD GROUP LLC	2260 East Imperial, Highway, El Segundo, 90245, California, California, E. U. DE NORTEAMERICA	218
496175	23/09/2022	JUREMA	29 y 30	ODERICH ALIMENTOS LTDA.	Avenida Alvares Cabral, no. 1707, 1° andar-parte Bairro Santo Agostinho, Belo Horizonte, BRASIL	201
498703	08/09/2022	DIFFERIN	5	Galderma Holding S.A.	Zählerweg 10, 6300, ZUG, SUIZA	245
498703	22/09/2022	DIFFERIN	5	Galderma Holding S.A.	Zählerweg 10, 6300, ZUG, SUIZA	245
500265	06/09/2022	JEAN PAUL GAULTIER LE MALE	3	PUIG FRANCE	325 Rue Saint Martin, Paris, -, -, FRANCIA	144
503569	12/09/2022	NUTRADERM	5	Galderma Holding S.A.	Zählerweg 10, 6300, ZUG, SUIZA	245
503569	23/09/2022	NUTRADERM	5	Galderma Holding S.A.	Zählerweg 10, 6300, ZUG, SUIZA	245
504119	26/09/2022	BABY SHARK	28	The Pinkfong Company, Inc.	(Seocho-dong, 5th Floor), 94, Myeongdal-ro, Seocho-gu,, Seoul, Seoul, Seoul, COREA DEL SUR	201

N° Exp.	Resolución	Denominación	Clases	Titular	Dirección	Ag.
504122	30/09/2022	PINKFONG	28	The Pinkfong Company, Inc.	(Seocho-dong, 5th Floor), 94, Myeongdal-ro, Seocho-gu., Seoul, Seoul, Seoul, COREA DEL SUR	201
504133	08/09/2022		35, 36, 37, 39 y 40	Mercedes-Benz Group AG.	Mercedesstraße 120, 70372, Stuttgart, ALEMANIA	34
504134	08/09/2022	MERCEDES-BENZ	35, 36, 37, 39 y 40	Mercedes-Benz Group AG.	Mercedesstraße 120, 70372 , Stuttgart, ALEMANIA	34
504135	08/09/2022		4 y 12	Mercedes-Benz Group AG.	Mercedesstraße 120, 70372, Stuttgart, ALEMANIA	34
505508	08/09/2022	MERCEDES BENZ	4, 7 y 12	Mercedes-Benz Group AG.	Mercedesstraße 120, 70372 , Stuttgart, ALEMANIA	34
506248	02/09/2022	HOZON	9 y 12	Hozon New Energy Automobile Co., Ltd.	No.998, Tongren Road, Wutong Street, Tongxiang city, Jiaxing city, Zhejiang Province, Zhejiang Province, CHINA	144
506249	02/09/2022	NETA	12	Hozon New Energy Automobile Co., Ltd.	No.998, Tongren Road, Wutong Street, Tongxiang city, Jiaxing city, Zhejiang Province, Zhejiang Province, CHINA	144
506778	20/09/2022	AIC ECONOMÍA & FINANZAS	36	AIC ECONOMIA Y FINANZAS S.A.S.	BENITO NARDONE 2273, MONTEVIDEO, MONTEVIDEO, MONTEVIDEO, URUGUAY	201
508393	20/09/2022	CLOBEX	5	Galderma Holding S.A.	Zählerweg 10, 6300, ZUG, SUIZA	245
508393	09/09/2022	CLOBEX	5	Galderma Holding S.A.	Zählerweg 10, 6300, ZUG, SUIZA	245
508987	06/09/2022	FLEUR DU MALE	3	PUIG FRANCE	325 Rue Saint Martin, Paris, -, -, FRANCIA	144
511456	08/09/2022	GUARD	12 y 37	Mercedes-Benz Group AG.	Mercedesstraße 120, 70372, Stuttgart, ALEMANIA	34
513266	08/09/2022		2, 3, 4, 7, 9, 11, 12, 16, 27, 34 y 37	Mercedes-Benz Group AG.	Mercedesstraße 120, 70372 , Stuttgart, ALEMANIA	34

N° Exp.	Resolución	Denominación	Clases	Titular	Dirección	Ag.
514095	23/09/2022	NUTRACORT	5	Galderma Holding S.A.	Zählerweg 10, 6300, ZUG, SUIZA	245
514095	12/09/2022	NUTRACORT	5	Galderma Holding S.A.	Zählerweg 10, 6300, ZUG, SUIZA	245
514096	23/09/2022	IONAX	5	Galderma Holding S.A.	Zählerweg 10, 6300, ZUG, SUIZA	245
514096	09/09/2022	IONAX	5	Galderma Holding S.A.	Zählerweg 10, 6300, ZUG, SUIZA	245
514375	13/09/2022	RESTYLANE	5	Galderma Holding S.A.	Zählerweg 10, 6300, ZUG, SUIZA	245
514375	27/09/2022	RESTYLANE	5	Galderma Holding S.A.	Zählerweg 10, 6300, ZUG, SUIZA	245
514376	14/09/2022	TETRALYSAL	5	Galderma Holding S.A.	Zählerweg 10, 6300, ZUG, SUIZA	245
514376	28/09/2022	TETRALYSAL	5	Galderma Holding S.A.	Zählerweg 10, 6300, ZUG, SUIZA	245
514431	08/09/2022	SPRINTER	12	Mercedes-Benz Group AG.	Mercedesstraße 120, Stuttgart, Stuttgart, 70372, 70372, ALEMANIA	34
516910	08/09/2022	MAYBACH	9, 12, 14, 16, 18, 27, 28, 36, 37, 39 y 41	Mercedes-Benz Group AG.	Mercedesstraße 120, 70372 , Stuttgart, ALEMANIA	34
517050	01/09/2022	PICANA	9 y 17	Valls S.A.	Irala 433, Ciudad de Buenos Aires, ARGENTINA	221
518039	30/09/2022	PINKFONG	16	The Pinkfong Company, Inc.	(Secho-dong, 5th Floor), 94, Myeongdal-ro., Seocho-gu., Seoul, Seoul, COREA DEL SUR	201
518040	30/09/2022	PINKFONG WONDERSTAR	16 y 28	The Pinkfong Company, Inc.	(Secho-dong, 5th Floor), 94, Myeongdal-ro., Seocho-gu., Seoul, Seoul, COREA DEL SUR	201
518231	08/09/2022	MM	9, 12, 14, 16, 18, 27, 28, 36, 37, 39 y 41	Mercedes-Benz Group AG.	Mercedesstraße 120, 70372 , Stuttgart, ALEMANIA	34
519287	08/09/2022		7	Mercedes-Benz Group AG.	Mercedesstraße 120, 70372 , Stuttgart, ALEMANIA	34
519302	08/09/2022		12	Mercedes-Benz Group	Mercedesstraße 120, 70372 ,	34

N° Exp.	Resolución	Denominación	Clases	Titular	Dirección	Ag.
				AG.	Stuttgart, , ALEMANIA	
519303	08/09/2022		12	Mercedes-Benz Group AG.	Mercedesstraße 120, , 70372 , Stuttgart, , ALEMANIA	34
519364	08/09/2022	MERCEDES BENZ	38, 41, 42, 43, 44 y 45	Mercedes-Benz Group AG.	Mercedesstraße 120, 70372 , Stuttgart, ALEMANIA	34
519431	08/09/2022		35, 36, 37, 38, 39, 40, 41, 42, 43, 44 y 45	Mercedes-Benz Group AG.	Mercedesstraße 120, 70372 , Stuttgart, ALEMANIA	34
519560	05/09/2022	CRIOLLOS S.C.C.C.U.	16, 18, 20, 21, 24, 25, 41 y 43	ASOCIACION CIVIL DE CRIADORES DE CABALLOS CRIOLLOS DEL URUGUAY	URUGUAY 864, PISO 2, Montevideo, 11000, Montevideo, Montevideo, URUGUAY	245
520262	26/09/2022	TERRA BELLA	29 y 30	ODERICH ALIMENTOS LTDA.	Avenida Alvares Cabral, no. 1707, 1° andar-parte Bairro Santo Agostinho, Belo Horizonte, BRASIL	201
520263	26/09/2022	JUSSARA	29 y 30	ODERICH ALIMENTOS LTDA.	Avenida Alvares Cabral, no. 1707, 1° andar-parte Bairro Santo Agostinho, Belo Horizonte, BRASIL	201
520417	08/09/2022	MERCEDES	35, 36, 37, 38, 39, 40, 41, 42, 43, 44 y 45	Mercedes-Benz Group AG.	Mercedesstraße 120, 70372 , Stuttgart, ALEMANIA	34
521786	08/09/2022	EPIDUO	5	Galderma Holding S.A.	Zählerweg 10, 6300, ZUG, SUIZA	245
521786	22/09/2022	EPIDUO	5	Galderma Holding S.A.	Zählerweg 10, 6300, ZUG, SUIZA	245
521792	12/09/2022	METROGEL	5	Galderma Holding S.A.	Zählerweg 10, 6300, ZUG, SUIZA	245
521792	23/09/2022	METROGEL	5	Galderma Holding S.A.	Zählerweg 10, 6300, ZUG, SUIZA	245
521793	13/09/2022	ORACEA	5	Galderma Holding S.A.	Zählerweg 10, 6300, ZUG, SUIZA	245
521793	26/09/2022	ORACEA	5	Galderma Holding S.A.	Zählerweg 10, 6300, ZUG, SUIZA	245

N° Exp.	Resolución	Denominación	Clases	Titular	Dirección	Ag.
521794	07/09/2022	AVIXIS	5	Galderma Holding S.A.	Zählerweg 10, 6300, ZUG, SUIZA	245
521794	20/09/2022	AVIXIS	5	Galderma Holding S.A.	Zählerweg 10, 6300, ZUG, SUIZA	245
523909	08/09/2022	MERCEDES-EQ	12	Mercedes-Benz Group AG.	Mercedesstrasse 120, Stuttgart, 70372, -, -, ALEMANIA	34
523959	08/09/2022	MERCEDES-EQ	3, 6, 7, 8, 9, 11, 14, 16, 18, 20, 21, 24, 25, 27 y 28	Mercedes-Benz Group AG.	Mercedesstrasse 120, Stuttgart, 70372, -, -, ALEMANIA	34
524115	09/09/2022	MERCEDES-EQ	35, 36, 37, 39, 41 y 43	Mercedes-Benz Group AG.	Mercedesstrasse 120, Stuttgart, 70372, -, -, ALEMANIA	144
534193	12/09/2022		1, 4, 7 y 9	Mercedes-Benz Group AG.	Mercedesstraße 120, 70372 , Stuttgart, ALEMANIA	34
536707	12/09/2022		1, 2, 3, 4, 5, 6, 7, 8, 9, 10, 11, 12, 13, 14, 15, 16, 17, 18, 19, 20, 21, 22, 23, 24, 25, 26, 27, 28, 29, 30, 31, 32, 33 y 34	Mercedes-Benz Group AG.	Mercedesstraße 120, 70372 , Stuttgart, ALEMANIA	34
536960	12/09/2022	MERCEDES BENZ	1, 2, 3, 4, 5, 6, 7, 8, 9, 10, 12, 23 y 25	Mercedes-Benz Group AG.	Mercedesstraße 120, 70372 , Stuttgart, ALEMANIA	34
537297	12/09/2022	MERCEDES	1, 2, 3, 4, 5, 6, 7, 8, 9, 10, 12, 13, 14, 15, 16, 17, 18, 19, 20, 21, 22, 23 y 25	Mercedes-Benz Group AG.	Mercedesstraße 120, 70327, Stuttgart, ALEMANIA	34
539283	12/09/2022	MERCEDES BENZ	1, 4, 7, 9 y 12	Mercedes-Benz Group AG.	Mercedesstraße 120, 70327, Stuttgart, ALEMANIA	34
539425	12/09/2022		1, 2, 3, 4, 5, 6, 7, 8, 9, 10, 11, 12, 13, 14, 15, 16, 17, 18, 19, 20, 21, 22, 23, 24, 25, 26, 27, 28, 29, 30, 31, 32, 33, 34, 35, 36, 37, 38, 39, 40, 41, 42, 43, 44 y 45	Mercedes-Benz Group AG.	Mercedesstraße 120, 70372 , Stuttgart, ALEMANIA	34
540719	05/09/2022	CRIOLLOS	8	ASOCIACION CIVIL DE CRIADORES DE CABALLOS CRIOLLOS DEL	Uruguay 864, 2° piso, Montevideo, Montevideo, Montevideo, URUGUAY	245

N° Exp.	Resolución	Denominación	Clases	Titular	Dirección	Ag.
				URUGUAY		
541873	26/09/2022	ACEROS PAISANO	6	Acerospaisano S.A.	Carlos Maria Ramirez 1035, Montevideo, Montevideo, Montevideo, URUGUAY	220

CAMBIOS DE NOMBRE DE PATENTES

N° Exp.	Resolución	Titular	Dirección	Ag.
035279	20/09/2022	Corteva Agriscience LLC		20
035282	21/09/2022	CORTEVA AGRISCIENCE LLC		20
035283	21/09/2022	Corteva Agriscience LLC		20
035430	13/09/2022	Corteva Agriscience LLC		20
035779	20/09/2022	Corteva Agriscience LLC		20
035895	08/09/2022	Corteva Agriscience LLC		20
035954	16/09/2022	CORTEVA AGRISCIENCE LLC		20
035983	15/09/2022	Corteva Agriscience LLC.		20

CAMBIOS DE DOMICILIO

N° Exp.	Resolución	Denominación	Clases	Titular	Dirección	Ag.
385939	22/09/2022	BURLINGTON	24 y 25	BURLINGTON INDUSTRIES LLC y FALKE AG	804 Green Valley Road, suite 300, 27408, Greensboro, North Carolina, E. U. DE NORTEAMERICA y Wrightstrasse 9, 8152, Glattpark (Opfikon), SUIZA	194
388622	09/09/2022	TERGEN PHARMA	5	JOSÉ IGNACIO FERNANDEZ MARTÍNEZ	Guardizabal 1609 , Montevideo, Montevideo, URUGUAY	181
395085	19/09/2022	SAXE OSADIE	3	DISTRIFAR S.R.L.	RAMBLA REPÚBLICA DEL PERÚ 781 APTO. 301 , MONTEVIDEO, URUGUAY	201
395313	12/09/2022		36 y 44	THE BRITISH UNITED PROVIDENT	1 Angel Court, London EC2R 7HJ, EC2R 7HJ, London, GRAN	18

N° Exp.	Resolución	Denominación	Clases	Titular	Dirección	Ag.
				ASSOCIATION LIMITED	BRETAÑA (REINO UNIDO)	
395743	05/09/2022	UNIMED	3 y 5	HUGO FABIAN ETCHEPARE MARIN	Molinos de Raffo 523, Montevideo, URUGUAY	
397411	20/09/2022	D' AUCY	29	D'AUCY FRANCE	Kerlurec-Sain Leonard Nort, 56450, Theix, FRANCIA	245
398979	02/09/2022	MURILLO RUFFINELLI MOREIRA MRM	35, 36 y 39	MURILLO, RUFFINELLI, MOREIRA S.R.L.	Misiones 1537 P. 5, Montevideo, URUGUAY	94
399275	23/09/2022	ENCUENTRA	38	ADMINISTRACION NACIONAL DE TELECOMUNICACIONES (ANTEL)	TORRE DE ANTEL GUATEMALA 1075, Montevideo, Montevideo, URUGUAY	144
399397	09/09/2022	PANEX CITRUS	21	SEB DO BRASIL PRODUTOS DOMESTICOS LTDA.	Av. Arno, n° 146, parte Mooca , 031800-900, São Paulo, BRASIL	34
399566	26/09/2022	CEPSA	4	COMPañIA ESPAÑOLA DE PETRÓLEOS, S.A.	Pº De La Castellana, 259 A, 28046, Madrid, ESPAÑA	181
400336	23/09/2022	ADINET	38 y 41	ADMINISTRACION NACIONAL DE TELECOMUNICACIONES (ANTEL)	TORRE DE ANTEL GUATEMALA 1075, Montevideo, Montevideo, URUGUAY	144
400413	13/09/2022	APRECIN	5	Galderma Holding S.A.	Zählerweg 10 , 6300, ZUG, SUIZA	245
405685	23/09/2022	VIAJERITO	30	MANTRA S.A.	CARLOS A. LOPEZ 7700, MONTEVIDEO, URUGUAY	144
405964	20/09/2022	RESTORADERM	3, 5 y 10	Galderma Holding S.A.	Zählerweg 10, 6300, ZUG, SUIZA	245
410130	13/09/2022	NEW BALANCE	18 y 25	NEW BALANCE ATHLETICS, INC.	100 Guest Street , 02135, Boston, Massachusetts, E. U. DE NORTEAMERICA	21
410526	13/09/2022	CITIINTERNATIONAL	36	CITIGROUP INC.	388 Greenwich Street, 10013, New York, New York, E. U. DE	20

N° Exp.	Resolución	Denominación	Clases	Titular	Dirección	Ag.
					NORTEAMERICA	
410724	16/09/2022	CEGELEC	7, 9, 11 y 12	VINCI ENERGIES (société anonyme)	280, rue du 8 mai 1945, 78360, Montesson, FRANCIA	219
411085	02/09/2022	BALASTRO	33	AGROLAND S.A.	Bvar. General Artigas 420, P 1, 11300, Montevideo, URUGUAY	216
411658	23/09/2022	TVS	12	SUNDARAM- CLAYTON LIMITED	“Chaitanya”, No.12, Khader Nawaz Khan Road, Nungambakkam, Chennai , 600006, Tamil Nadu, INDIA	94
411767	13/09/2022	IDEAL	32	MYROSUR S.A.	Bv. José Batlle y Ordoñez 6781, 12900, Montevideo, URUGUAY	18
412326	13/09/2022	STORZ	9	BAUSCH & LOMB INCORPORATED	1400 North Goodman Street, 14604-2701, Rochester, New York, E. U. DE NORTEAMERICA	192
412848	13/09/2022	ARTANE	5	WYETH HOLDINGS LLC	235 East 42nd Street, 10017, New York, New York, E. U. DE NORTEAMERICA	165
413479	13/09/2022	STANLEY STEEMER	37	STANLEY STEEMER INTERNATIONAL,INC.	5800 Innovation Dr., 43016, Dublin, Ohio , E. U. DE NORTEAMERICA	20
413502	07/09/2022	S SENNA	16	AYRTON SENNA EMPREENDIMIENTOS LTDA.	Rua Doutor Fernandes Coelho, 85 - Andar 13, Sala 05, Pinheiros , 05423-040, Sao Paulo, SP, BRASIL	245
413916	21/09/2022		12 y 37	BEIBEN TRUCKS GROUP CO., LTD.	NO.9 BINGGONG EAST ROAD, EQUIPMENT MANUFACTURING, INDUSTRY PARK , BAOTOU CITY, INNER MONGOLIA AUTONOMOUS REGION, CHINA	34
414986	07/09/2022	AGU	29	ALINTER, S.A.	Curridabat, San José, del indoor club trescientos metros este y	205

N° Exp.	Resolución	Denominación	Clases	Titular	Dirección	Ag.
					Cien Norte, COSTA RICA	
416318	23/09/2022	CHIQUITA	29, 30, 31 y 32	CHIQUITA BRANDS L.L.C.	DCOTA Office Center, 1855 Griffin Road, Suite C-436, 33004-2275, FORT-LAUDERDALE, FLORIDA, E. U. DE NORTEAMERICA	34
416717	16/09/2022	EMERVEL	3, 5 y 10	Galderma Holding S.A.	Zählerweg 10, 6300, ZUG, SUIZA	245
416783	19/09/2022	PIASCLEDINE	5	LABORATOIRES EXPANSCIENCE	1 place des Saisons, 92048 , Paris La Defense Cedex, FRANCIA	219
416784	19/09/2022	DERRUMAL	5	LABORATOIRES EXPANSCIENCE	1 place des Saisons, 92048 , Paris La Defense Cedex, FRANCIA	219
418010	08/09/2022	ROCA MOBILE	9	MANCRU S.A.	PAYSANDU 1175, Montevideo, URUGUAY	201
418070	01/09/2022	ROBUSTAN	5	KÖNIG URUGUAY SOCIEDAD ANONIMA	García Lagos y Camino al Paso Hondo, – Colonia Nicolich –, Canelones, URUGUAY	129
418443	02/09/2022	RINCÓN DEL HINCHA	35 y 41	LOTIZEN S.A.	Avenida 8 de octubre 3666, Montevideo, URUGUAY	154
418445	02/09/2022	LOTIZEN	35 y 41	LOTIZEN S.A.	Avenida 8 de octubre 3666, Montevideo, URUGUAY	154
418900	07/09/2022	COMFEE	7 y 11	GD MIDEA AIR-CONDITIONING EQUIPMENT CO., LTD.	Lingang Road, Beijiao Town, Shunde District, Foshan City, Guangdong Province, CHINA	180
418999	02/09/2022	KILAFEN	31, 35, 39 y 44	KILAFEN S.A.	Ruta 5 Km 167,5, Goñi, Florida, URUGUAY	221
419000	02/09/2022	KILAFEN	31, 35, 39 y 44	KILAFEN S.A.	Ruta 5 Km 167,5, Goñi, Florida, URUGUAY	205
419577	29/09/2022	CEDUANCE	3, 5 y 10	Galderma Holding S.A.	Zählerweg 10, 6300, ZUG, SUIZA	245
419579	29/09/2022	AKTILITE	10	Galderma Holding S.A.	Zählerweg 10, 6300, ZUG, SUIZA	245

N° Exp.	Resolución	Denominación	Clases	Titular	Dirección	Ag.
419720	05/09/2022	GABRIEL	12	RIDE CONTROL, LLC	39300 Country Club Drive, 48331, Farmington Hills, MICHIGAN, E. U. DE NORTEAMERICA	194
419726	07/09/2022	LASSO	10	BIOSENSE WEBSTER, INC.	31 Technology Drive, Suite 200, 92618, Irvine, CA, E. U. DE NORTEAMERICA	194
419727	07/09/2022	QWIK CABLE	10	BIOSENSE WEBSTER, INC.	31 Technology Drive, Suite 200, 92618, Irvine, CA, E. U. DE NORTEAMERICA	194
419868	23/09/2022	F FRAM	7 y 12	FRAM GROUP IP LLC	127 Public Square Suite 5300, 441144, CLEVELAND, OHIO, E. U. DE NORTEAMERICA	144
419936	01/09/2022	PLANET XTRA	5	SYNGENTA LIMITED	Jealott's Hill International Research Centre, RG42 6EY, Bracknell, Berkshire, GRAN BRETAÑA (REINO UNIDO)	194
420180	07/09/2022	GAES	10	AMPLIFON IBÉRICA S.A.	Avenida de Madrid, 199 bajos, 50017 , Zaragoza, ESPAÑA	201
420387	12/09/2022	COOPAR BLUE PATNA EL SABOR DEL ARROZ; MEZCLA PARA PREPARAR; READY PREPARED FOR COOKING; ARROZ CON HONGOS & HIERBAS MUSHROOMS, THIN HERBS & RICE; APROX. 5 PORCIONES; APPROX. 5 SERVING; PESO NETO 227 G/NET WT.8 OZ; INDUSTRIA URUGUAYA	30	COOPAR S.A.	Cno Paul Castaibert 4960 , MONTEVIDEO, URUGUAY	245
420399	07/09/2022	MINDNUTRITION	43 y 44	SILVINA TOCHETTI MEDEIROS	Avenida del Ombú 7085 esquina Camino Pichincha, Complejo	194

N° Exp.	Resolución	Denominación	Clases	Titular	Dirección	Ag.
					San Nicolás, Montevideo, URUGUAY	
420403	13/09/2022	MILESTONE	35	ACTIVIST ADMINISTRAÇÃO DE BENS PRÓPRIOS LTDA.	RUA TABAPUÁ, N° 145, SALA 36, ITAIM BIBI, SÃO PAULO , SP, BRASIL	34
420407	19/09/2022	BENJAMIN	33	DANTE IRURTIA S.A.	Ramal Ruta 97 km 2300, CARMELO , COLONIA, URUGUAY	219
420884	01/09/2022	MONAMI	16	MONAMI CO. LTD.	17, Songok-ro, Suji-gu, Yongin- si, Gyeonggi-do, COREA DEL SUR	194
420918	15/09/2022	PROVINCIA P CASA FINANCIERA	16, 35 y 36	BANCO DE LA PROVINCIA DE BUENOS AIRES	LUIS A. DE HERRERA 1248, TORRE II Of. 111, Montevideo, URUGUAY	201
421247	21/09/2022	VULCANO	32	I 9 - COMÉRCIO E ATACADO DE ALIMENTOS, BEBIDAS E MATERIAS PRIMAS LTDA	Est Fazenda Meia Lua, Estrada dos Pirineus, sn. Quadra 3, Lote 3, Km 1- Zona Rural, 72950-000, Pirenópolis, GO, BRASIL	34
421409	14/09/2022	FUNTAINER	21	THERMOS L.L.C.	475 N. Martingale Road Suite 1100 , Schaumburg , 60173 , IL, E. U. DE NORTEAMERICA	216
421457	09/09/2022	Q PRO SISTEMA INTEGRADO DE PROTECCION	31	BARRACA JORGE W. ERRO S.A.	Perimetral Juan Manuel Blanes y Carlos María Ruiz, DOLORES, SORIANO, URUGUAY	34
421801	28/09/2022	CIROMAS 75 PM	5	POINT AMERICAS S.A.	Potosí 1517, Montevideo, URUGUAY	129
421802	28/09/2022	FUNGIZEB 80 PM	5	POINT AMERICAS S.A.	Potosí 1517, Montevideo, URUGUAY	129
421926	23/09/2022	PERMETRIN PROMOFARMA	5	PROMOFARMA S.R.L.	Juan D. Jackson 1015 , Montevideo, Montevideo, URUGUAY	19

N° Exp.	Resolución	Denominación	Clases	Titular	Dirección	Ag.
421927	23/09/2022	XYLISOL PROMOFARMA	5	PROMOFARMA S.R.L.	Juan D. Jackson 1015 , Montevideo, Montevideo, URUGUAY	19
421929	23/09/2022	NEOQUIN PROMOFARMA	5	PROMOFARMA S.R.L.	Juan D. Jackson 1015 , Montevideo, Montevideo, URUGUAY	19
421935	14/09/2022	LIBBY EDELMAN	18, 25 y 35	EDELMAN SHOE, INC.	1325 Avenue of the Americas, 34th Floor, 10019, New York, NY, E. U. DE NORTEAMERICA	194
421936	14/09/2022	SAM EDELMAN	18, 25 y 35	EDELMAN SHOE, INC.	1325 Avenue of the Americas, 34th Floor, 10019, New York, NY, E. U. DE NORTEAMERICA	194
422040	21/09/2022	CREDICELTA	36	KALSENT S.A.	Eduardo Acevedo 1369, Montevideo, URUGUAY	245
422075	14/09/2022	DISCOVERY TURBO	38 y 41	DISCOVERY COMMUNICATIONS, LLC	230 Park Avenue South, 10003, New York, NY, E. U. DE NORTEAMERICA	194
422331	02/09/2022	CERAGEM	10 y 44	CERAGEM CO., LTD	10, Jeongja 1-gil, Seonggeo-eup, Seobuk-gu, 31045, Cheonan-si, Chungcheongnam-do, COREA DEL SUR	94
422567	08/09/2022	JEAN PAUL GAULTIER CLASSIQUE	3	PUIG FRANCE	65-67 avenue des Champs- Elysées, 75008 , Paris, FRANCIA	144
422797	23/09/2022	AEROCAM PROMOFARMA	10	PROMOFARMA SRL	Juan D. Jackson 1015 , Montevideo, Montevideo, URUGUAY	19
422883	09/09/2022	ZENTIVA	5	ZENTIVA GROUP A.S.	U kabelovny 529/16, 102 00, Praha 10, Dolní Mecholupy, REPUBLICA CHECA	201
423758	23/09/2022	TOMMY GIRL	9, 18, 24 y 25	TOMMY HILFIGER LICENSING LLC	285 Madison Avenue, 6th Floor, 10017, New York, NY, E. U. DE	194

N° Exp.	Resolución	Denominación	Clases	Titular	Dirección	Ag.
					NORTEAMERICA	
423758	16/09/2022	TOMMY GIRL	9, 18, 24 y 25	TOMMY HILFIGER LICENSING LLC	285 Madison Avenue, 6th Floor, 10017, New York, NY, E. U. DE NORTEAMERICA	194
423759	23/09/2022	TOMMY GIRL	9, 18, 24 y 25	TOMMY HILFIGER LICENSING LLC	285 Madison Avenue, 6th Floor, 10017, New York, NY, E. U. DE NORTEAMERICA	194
423759	16/09/2022	TOMMY GIRL	9, 18, 24 y 25	TOMMY HILFIGER LICENSING LLC	285 Madison Avenue, 6th Floor, 10017, New York, NY, E. U. DE NORTEAMERICA	194
424163	19/09/2022	PORCELLANATO CERRO NEGRO	19	CANTERAS CERRO NEGRO S.A.	Esmeralda 1320 Piso 7 A, (1007) , Ciudad Autónoma de Buenos Aires, ARGENTINA	34
424209	08/09/2022	COSTA URBANA	16, 35, 36, 37, 41, 42 y 43	Costa Urbana S.A.	Avenida Giannattasio Km 21, Administración Costa Urbana Shopping, Ciudad de la Costa, Canelones, URUGUAY	144
424704	26/09/2022	LOUNGE	12	AUTOMOBILES CITROËN	2-10 Boulevard de l'Europe, 78300, Poissy, FRANCIA	144
425053	28/09/2022	G	32	STOKELY-VAN CAMP, INC.	700 ANDERSON HILL ROAD, 10577, PURCHASE, NEW YORK, E. U. DE NORTEAMERICA	201
425216	27/09/2022	CYNAR	33	DAVIDE CAMPARI-MILANO N.V.	HERENGRACHT 420, 1017BZ, AMSTERDAM, PAISES BAJOS	34
425363	21/09/2022	PHI PHI TOYS	28	DIEGO ALFREDO VARELA ROSSI y GUSTAVO DANIEL CURUTCHAGUE CARRIQUIRY	Ramón del Valle Inclán 2582, Montevideo, URUGUAY y Ramón del Valle Inclán 2582, Montevideo, URUGUAY	144
425471	19/09/2022	W	28, 36, 41 y 43	WG ACQUISITION LIMITED	44 Esplanade St Helier, JE4 9WG, Jersey , GRAN BRETAÑA (REINO UNIDO)	245
425472	19/09/2022	WENTWORTH	28, 36, 41 y 43	WG ACQUISITION	44 Esplanade St Helier, JE4	245

N° Exp.	Resolución	Denominación	Clases	Titular	Dirección	Ag.
				LIMITED	9WG, Jersey , GRAN BRETAÑA (REINO UNIDO)	
425482	12/09/2022	BUPA	36 y 44	THE BRITISH UNITED PROVIDENT ASSOCIATION LIMITED	1 Angel Court, EC2R 7HJ, London, GRAN BRETAÑA (REINO UNIDO)	18
425627	26/09/2022		7, 9, 12, 25, 36, 37, 38, 39, 40, 41 y 42	AUTOMOBILES CITROËN	2-10 Boulevard de l'Europe, 78300, Poissy, FRANCIA	144
426112	23/09/2022	DUFRY	35	DUFRY INTERNATIONAL AG (DUFRY INTERNATIONAL SA) (DUFRY INTERNATIONAL LTD)	Brunnqässlein 12, 4052 , Basilea, SUIZA	218
426151	09/09/2022	LA GAVIOTA POLO LOGÍSTICO Y COMERCIAL	39	AGROPECUARIA SALTO	Ruta 3 y Pascual Harriague, Salto, Salto, URUGUAY	234
426805	26/09/2022	AZOLON	1	AGLUKON Spezialdünger GmbH & Co. KG,	Heerdter landstrasse 199, Düsseldorf, ALEMANIA	194
426851	23/09/2022	ECOPLAST	21	ANDREA ELIZABET DA FONSECA MACHADO	ORLEANS 2236, MONTEVIDEO, URUGUAY	
426972	28/09/2022		1, 6, 7, 8, 12 y 17	COMPAGNIE GÉNÉRALE DES ETABLISSEMENTS MICHELIN	23, PLACE DES CARMES- DECHAUX , 63000, Clermont, Ferrand, FRANCIA	181
427046	02/09/2022	AIR CHINA	39	AIR CHINA LIMITED	Room 101, 1st to 9th Floor, Building 1, No.30, Tian Zhu Road , Shun Yi District, 101312, Beijing, CHINA	34
427047	02/09/2022	AIR CHINA	39	AIR CHINA LIMITED	Room 101, 1st to 9th Floor, Building 1, No.30, Tian Zhu	34

N° Exp.	Resolución	Denominación	Clases	Titular	Dirección	Ag.
					Road , Shun Yi District, 101312, Beijing, CHINA	
427048	02/09/2022		39	AIR CHINA LIMITED	Room 101, 1st to 9th Floor, Building 1, No.30, Tian Zhu Road , Shun Yi District, 101312, Beijing, CHINA	34
427662	26/09/2022	SOFINNOVA	36	Sofinnova Investments, Inc.	3000 Sand Hill Rd., Bldg. 4, Suite 250, 94025, Menlo Park, California , E. U. DE NORTEAMERICA	201
429058	22/09/2022	MICHELIN	5, 7, 8, 9, 10, 11, 12, 16, 17, 18, 20, 21, 24, 25, 39 y 43	COMPAGNIE GÉNÉRALE DES ETABLISSEMENTS MICHELIN	23, PLACE DES CARMES-DECHAUX, 63000, CLERMONT-FERRAND, FRANCIA	201
429272	02/09/2022	FORD EDGE	12	FORD MOTOR COMPANY	One American Road, 48126, Dearborn, MI, E. U. DE NORTEAMERICA	194
429529	27/09/2022	DAEWOO	12	POSCO INTERNATIONAL Corporation	134, Teheran-Ro, Gangnam-gu, Seoul, COREA DEL SUR	242
429582	19/09/2022	FINESA	35 y 39	FINESA TRADING S.A.	AEROSUR 8516 ESQ. AV. GIANNATTASIO, SAN JOSÉ DE CARRASCO, CANELONES, URUGUAY	201
429745	02/09/2022	COBERTOR PROTECTOR	1	RIZOBACTER ARGENTINA S.A.	Av. Dr. Arturo Frondizi N° 1150, Parque Industrial Pergamino, Pergamino, Buenos Aires, ARGENTINA	34
429820	20/09/2022	TESSA	3	MARIA VICTORIA LLISO ROIG	Avda. Del Puerto, 33, 46021, Valencia, ESPAÑA	212
430301	13/09/2022	VIAAQUA SPA	3, 5, 16 y 25	MONT GROUP S.A.	VICTOR SOLIÑO 375, Montevideo, URUGUAY	245
430473	01/09/2022	FORD FIGO	12	FORD MOTOR COMPANY	One American Road, 48126, Dearborn, MI, E. U. DE	194

N° Exp.	Resolución	Denominación	Clases	Titular	Dirección	Ag.
					NORTEAMERICA	
430682	23/09/2022	GARNIÉ	16 y 18	ANDREA CAPPI	Bernardino Báez 481, Montevideo, URUGUAY	
431296	21/09/2022	MERCUISER	7	BRUNSWICK CORPORATION	W6250 Pioneer Road, P.O. Box 1939 Fond du Lac, 54936-1939, Wisconsin , E. U. DE NORTEAMERICA	245
431297	21/09/2022	MARINER	7	BRUNSWICK CORPORATION	W6250 Pioneer Road, P.O. Box 1939 Fond du Lac, 54936-1939, Wisconsin , E. U. DE NORTEAMERICA	245
431298	23/09/2022	QUICKSILVER	4	BRUNSWICK CORPORATION	W6250 Pioneer Road, P.O. Box 1939 Fond du Lac, 54936-1939, Wisconsin , E. U. DE NORTEAMERICA	245
431477	16/09/2022	EMERGER FERTILIZANTES	1	EMERGER FERTILIZANTES S.A.	Leandro L. Alem 584 - Piso 10, 1001, Ciudad Autónoma de Buenos Aires, ARGENTINA	245
431672	19/09/2022	EL OBSERVADOR	16 y 41	MICROCOSMOS S.A.	Ejido 1275, Montevideo, Montevideo, URUGUAY	205
431822	01/09/2022	FORD GO FURTHER	12	FORD MOTOR COMPANY	One American Road, 48126, Dearborn, MI, E. U. DE NORTEAMERICA	194
432762	07/09/2022	UCAR	1	UNION CARBIDE CORPORATION	7501 State Highway, 185 North Seadrift, 77983, Texas, E. U. DE NORTEAMERICA	216
432781	02/09/2022	INMUSAFE	5	RINQUE PHARMA S.A.	SANLUCAR 1545, MONTEVIDEO, URUGUAY	34
432782	02/09/2022	INMUGRAF	5	RINQUE PHARMA S.A.	SANLUCAR 1545, MONTEVIDEO, URUGUAY	34
435558	14/09/2022	SAFOL	1 y 3	SASOL LIMITED	Sasol Place, 50 Katherine Street, Sandton, 2196, SUDAFRICA	216
435754	01/09/2022	ARIOLA	9	SONY MUSIC ENTERTAINMENT	Balanstr. 73, Haus 31, 81541, Munich, ALEMANIA	201

N° Exp.	Resolución	Denominación	Clases	Titular	Dirección	Ag.
				INTERNATIONAL SERVICES GMBH		
435755	01/09/2022	ODYSSEY	9	SONY MUSIC ENTERTAINMENT	25 Madison Avenue, 10010, New York, NY, E. U. DE NORTEAMERICA	201
436373	05/09/2022	SONDA	35 y 42	SONDA URUGUAY S.A.	Río Negro 1320 Piso 6 y 7, Montevideo, URUGUAY	94
436386	02/09/2022	ALEXANDER MCQUEEN	3	AUTUMNPAPER LIMITED	5th Floor, Rear Suite Oakfield House, 35 Perrymount Road, Haywards Heath, RH 16 3BW, West Sussex, GRAN BRETAÑA (REINO UNIDO)	201
437911	05/09/2022	TEVA	5	TEVA PHARMACEUTICAL INDUSTRIES LTD.	124 Dvora HaNevi'a Tel Aviv-Jaffa, 6944020, ISRAEL	245
438203	29/09/2022	BALENCIAGA	3, 9, 14, 18, 21, 24, 25 y 26	BALENCIAGA	40 rue de Sèvres, Paris, 75007, Paris, FRANCIA	194
438228	29/09/2022	A Q-MED ALLIANCE	38, 41 y 44	Galderma Holding S.A.	Zählerweg 10, 6300, ZUG, SUIZA	245
438251	16/09/2022	40	3 y 5	ELECTROQUIMICA S.A.	Antigua Continuación Colman 5827, Montevideo, URUGUAY	194
438252	16/09/2022	HIPOSOL	1, 3 y 5	ELECTROQUIMICA S.A.	Antigua Continuación Colman 5827, Montevideo, URUGUAY	194
438253	16/09/2022	SATURNO	21	ELECTROQUIMICA S.A.	Antigua Continuación Colman 5827, Montevideo, URUGUAY	194
438254	16/09/2022	SATURNO	1, 3 y 5	ELECTROQUIMICA S.A.	Antigua Continuación Colman 5827, Montevideo, URUGUAY	194
438255	09/09/2022	URSO	6	GERDAU S.A.	Avenida Doutora Ruth Cardoso, 8501, Andar 8, Conj. 2, 05425-070, PINHEIROS, SAO PAULO, BRASIL	194
438257	16/09/2022	APITOX	5	APITOX S.A.	MERCEDES 1245, Montevideo, Montevideo, URUGUAY	105
438286	16/09/2022	ESCALA	16	ELECTROQUIMICA	Antigua Continuación Colman	194

N° Exp.	Resolución	Denominación	Clases	Titular	Dirección	Ag.
				S.A.	5827, Montevideo, URUGUAY	
438290	16/09/2022	ALADDIN	11	ALADDIN INDUSTRIES, LLC	804 Lynnwood Blvd., 37205, Nashville, Tennessee, E. U. DE NORTEAMERICA	194
438561	29/09/2022	AQUACLIN	3	Galderma Holding S.A.	Zählerweg 10, 6300, ZUG, SUIZA	245
438679	29/09/2022	BENZAC	3	Galderma Holding S.A.	Zählerweg 10, 6300, ZUG, SUIZA	245
438704	01/09/2022	TREVE	3	DISTRIFAR S.R.L.	RAMBLA REPÚBLICA DEL PERÚ 781 APTO. 301, MONTEVIDEO, URUGUAY	201
439145	30/09/2022	INVESTCORP	36	INVESTCORP S.A.	c/o Paget-Brown Trust Company Ltd. Century Yard, Cricket Square, P.O. Box 1111, KY1-1102, Grand Cayman, ISLAS CAIMAN	34
439706	30/09/2022	A ATLAS	28	EPICUS S.A.	AREQUITA 2282 BIS, Montevideo, Montevideo, URUGUAY	220
439821	01/09/2022	FARMACITY	5, 42 y 44	FARMACITY S.A.	Avda Santa Fe 2830 Piso 1, C1425BGC, Ciudad Autonoma de Buenos Aires, ARGENTINA	245
440496	05/09/2022	SABROSERO	29	EDIC S.A.	Misiones 1372 402, Montevideo, URUGUAY	154
441764	29/09/2022	BENZIHEX	5	Galderma Holding S.A.	Zählerweg 10, 6300, ZUG, SUIZA	245
442478	08/09/2022	VITO	12	Mercedes-Benz Group AG.	Mercedesstraße 120, 70372 , Stuttgart, ALEMANIA	34
445013	06/09/2022		36	Rothschild & Co Continuation Holdings AG	Baarerstrasse 95, 6300, Zug, SUIZA	194
446196	29/09/2022	AFONGAN	5	Galderma Holding S.A.	Zählerweg 10, 6300, ZUG, SUIZA	245
447209	23/09/2022	TOMMY	14	TOMMY HILFIGER	285 Madison Avenue, 6th Floor,	194

N° Exp.	Resolución	Denominación	Clases	Titular	Dirección	Ag.
				LICENSING LLC	10017, New York, NY, E. U. DE NORTEAMERICA	
447209	16/09/2022	TOMMY	14	TOMMY HILFIGER LICENSING LLC	285 Madison Avenue, 6th Floor, 10017, New York, NY, E. U. DE NORTEAMERICA	194
447459	29/09/2022	ACTINICA	3	Galderma Holding S.A.	Zählerweg 10, 6300, ZUG, SUIZA	245
448027	29/09/2022	AQUACLIN	3	Galderma Holding S.A.	Zählerweg 10, 6300, ZUG, SUIZA	245
448249	29/09/2022	BENZAKARE	3 y 10	Galderma Holding S.A.	Zählerweg 10, 6300, ZUG, SUIZA	245
451781	08/09/2022	JEAN PAUL GAULTIER	3, 18 y 25	PUIG FRANCE	65-67 avenue des Champs-Elysées , 75008, Paris, FRANCIA	144
454329	29/09/2022	CETAPHIL	3	Galderma Holding S.A.	Zählerweg 10, 6300, ZUG, SUIZA	245
454492	01/09/2022	TYTAN PROFESSIONAL	17	SELENA MARKETING INTERNATIONAL SP. Z O.O.	Legnicka 48A Street 54-202, Wroclaw , POLONIA	144
454847	06/09/2022	FIVE ARROWS	36	Rothschild & Co Continuation Holdings AG	Baarerstrasse 95, 6300, Zug, SUIZA	194
454848	06/09/2022		36	Rothschild & Co Continuation Holdings AG	Baarerstrasse 95, 6300, Zug, SUIZA	194
455513	29/09/2022	ACLINA	5	Galderma Holding S.A.	Zählerweg 10, 6300, ZUG, SUIZA	245
459650	15/09/2022	M	6	MUSTAD HOOFCARE SA	Rue de Gruyères 106, 1630, Bulle, SUIZA	34
463846	08/09/2022	TENESLUGAR	9, 36 y 39	Mercedes-Benz Group AG.	Mercedesstraße 120, 70372 , Stuttgart, ALEMANIA	34
464078	09/09/2022	MERCEDES	7 y 12	Mercedes-Benz Group AG.	Mercedesstraße 120, 70372 , Stuttgart, ALEMANIA	34
465081	29/09/2022	TOMMY JEANS	25	TOMMY HILFIGER	285 Madison Avenue, 6th Floor,	194

N° Exp.	Resolución	Denominación	Clases	Titular	Dirección	Ag.
				LICENSING LLC	10017, New York, NY, E. U. DE NORTEAMERICA	
465081	16/09/2022	TOMMY JEANS	25	TOMMY HILFIGER LICENSING LLC	285 Madison Avenue, 6th Floor, 10017, New York, NY, E. U. DE NORTEAMERICA	194
465829	26/09/2022	PSYCHO BUNNY	25	Psycho Bunny Inc.	5001-5003 rue Levy/5001-5003 Levy Street, H4R2N9, St. Laurent, Quebec, CANADA	194
465830	26/09/2022		25	Psycho Bunny Inc.	5001-5003 Levy Street, H4R2N9, St. Laurent, Quebec, CANADA	194
467023	06/09/2022	ROTHSCHILD & CO	36	Rothschild & Co Continuation Holdings AG	Baarerstrasse 95, 6300, Zug, SUIZA	194
471405	08/09/2022	MERCEDES BENZ	4, 6, 7, 8, 9, 11 y 12	Mercedes-Benz Group AG.	Mercedesstraße 120, 70372 , Stuttgart, ALEMANIA	34
471406	08/09/2022		4, 6, 7, 8, 9, 11 y 12	Mercedes-Benz Group AG.	Mercedesstraße 120, 70372 , Stuttgart, ALEMANIA	34
472525	06/09/2022	MINISO	3, 9, 14, 18, 21 y 25	Miniso Hong Kong Limited	Unit D, 16/F, One Capital Place, 18 Luard Road, Wan Chai, HONG KONG, HONG KONG	34
472712	16/09/2022	THE GIRL TOMMY HILFIGER	3	TOMMY HILFIGER LICENSING LLC	285 Madison Avenue, 6th Floor, 10017, New York, NY, E. U. DE NORTEAMERICA	194
472712	23/09/2022	THE GIRL TOMMY HILFIGER	3	TOMMY HILFIGER LICENSING LLC	285 Madison Avenue, 6th Floor, 10017, New York, NY, E. U. DE NORTEAMERICA	194
475404	29/09/2022	CETAPHIL	5	Galderma Holding S.A.	Zählerweg 10, 6300, ZUG, SUIZA	245
476448	06/09/2022		36	Rothschild & Co Continuation Holdings AG	Baarerstrasse 95, 6300, Zug, SUIZA	194
476449	08/09/2022		36	Rothschild & Co Continuation Holdings	Baarerstrasse 95, 6300, Zug, SUIZA	194

N° Exp.	Resolución	Denominación	Clases	Titular	Dirección	Ag.
				AG		
478110	15/09/2022	MUSTAD	5	MUSTAD HOOFCARE SA	Rue de Gruyères 106, 1630, Bulle, SUIZA	34
478111	15/09/2022		5	MUSTAD HOOFCARE SA	Rue de Gruyères 106, 1630, Bulle, SUIZA	34
478112	15/09/2022	MUSTAD	5	MUSTAD HOOFCARE SA	Rue de Gruyères 106, 1630, Bulle, SUIZA	34
482562	20/09/2022	BENZAC	5	Galderma Holding S.A..	Zählerweg 10 , 6300, ZUG, SUIZA	245
482831	15/09/2022		25	TOMMY HILFIGER LICENSING LLC	250 Madison Avenue, 6th Floor, 10017, New York, NY, E. U. DE NORTEAMERICA	194
485087	15/09/2022		3	TOMMY HILFIGER LICENSING LLC	250 Madison Avenue, 6th Floor, 10017, New York, NY, E. U. DE NORTEAMERICA	194
486977	15/09/2022		9	TOMMY HILFIGER LICENSING LLC	250 Madison Avenue, 6th Floor, 10017, New York, NY, E. U. DE NORTEAMERICA	194
486978	16/09/2022	TOMMY GIRL	3	TOMMY HILFIGER LICENSING LLC	250 Madison Avenue, 6th Floor, 10017, New York, NY, E. U. DE NORTEAMERICA	194
486979	16/09/2022	TOMMY HILFIGER	9	TOMMY HILFIGER LICENSING LLC	250 Madison Avenue, 6th Floor, 10017, New York, NY, E. U. DE NORTEAMERICA	194
489431	15/09/2022	CORONA	6	MUSTAD HOOFCARE SA	Rue de Gruyères 106, 1630, Bulle, SUIZA	34
489432	15/09/2022	CORONA	6	MUSTAD HOOFCARE SA	Rue de Gruyères 106, 1630, Bulle, SUIZA	34
490937	15/09/2022	JK	6	MUSTAD HOOFCARE SA	Rue de Gruyères 106, 1630, Bulle, SUIZA	34
493309	02/09/2022	SOUR PATCH KIDS ACIDOS PERO EN EL FONDO DULCES	30	Mondelez Canada Inc.	277 Gladstone Avenue, M6J3L9, Toronto, Ontario, CANADA	18
494188	02/09/2022	SOUR PATCH	30	Mondelez Canada Inc.	277 Gladstone Avenue, M6J3L9,	18

N° Exp.	Resolución	Denominación	Clases	Titular	Dirección	Ag.
					Toronto, Ontario, CANADA	
504133	08/09/2022		35, 36, 37, 39 y 40	Mercedes-Benz Group AG.	Mercedesstraße 120, 70372, Stuttgart, ALEMANIA	34
504134	09/09/2022	MERCEDES-BENZ	35, 36, 37, 39 y 40	Mercedes-Benz Group AG.	Mercedesstraße 120, 70372 , Stuttgart, ALEMANIA	34
504135	09/09/2022		4 y 12	Mercedes-Benz Group AG.	Mercedesstraße 120, 70372, Stuttgart, ALEMANIA	34
505508	09/09/2022	MERCEDES BENZ	4, 7 y 12	Mercedes-Benz Group AG.	Mercedesstraße 120, 70372 , Stuttgart, ALEMANIA	34
508145	15/09/2022	DERBY	6	MUSTAD HOOFCARE SA	Rue de Gruyères 106, 1630, Bulle, SUIZA	34
508659	26/09/2022	TRIKE DRIVE ELECTRIC	12	THELEATHERTECH SA	Ave. Italia 5052, 11400, Montevideo, Montevideo, URUGUAY	
510071	16/09/2022	TOMMY TOMMY HILFIGER	3	TOMMY HILFIGER LICENSING LLC	250 Madison Avenue, 6th Floor, 10017, New York, NY, E. U. DE NORTEAMERICA	194
510072	16/09/2022	TOMMY HILFIGER	3	TOMMY HILFIGER LICENSING LLC	250 Madison Avenue, 6th Floor, 10017, New York, NY, E. U. DE NORTEAMERICA	194
511456	09/09/2022	GUARD	12 y 37	Mercedes-Benz Group AG.	Mercedesstraße 120, 70372, Stuttgart, ALEMANIA	34
513266	09/09/2022		2, 3, 4, 7, 9, 11, 12, 16, 27, 34 y 37	Mercedes-Benz Group AG.	Mercedesstraße 120, 70372 , Stuttgart, ALEMANIA	34
516910	09/09/2022	MAYBACH	9, 12, 14, 16, 18, 27, 28, 36, 37, 39 y 41	Mercedes-Benz Group AG.	Mercedesstraße 120, 70372 , Stuttgart, ALEMANIA	34
517050	02/09/2022	PICANA	9 y 17	Valls S.A.	Irala 433, Ciudad de Buenos Aires, ARGENTINA	221
518231	09/09/2022	MM	9, 12, 14, 16, 18, 27, 28, 36, 37, 39 y 41	Mercedes-Benz Group AG.	Mercedesstraße 120, 70372 , Stuttgart, ALEMANIA	34
519287	09/09/2022		7	Mercedes-Benz Group AG.	Mercedesstraße 120, 70372 , Stuttgart, ALEMANIA	34
519302	09/09/2022		12	Mercedes-Benz Group AG.	Mercedesstraße 120, 70372 , Stuttgart, , ALEMANIA	34

N° Exp.	Resolución	Denominación	Clases	Titular	Dirección	Ag.
519303	09/09/2022		12	Mercedes-Benz Group AG.	Mercedesstraße 120, , 70372 , Stuttgart, , ALEMANIA	34
519305	09/09/2022		7	Mercedes-Benz Group AG.	Mercedesstraße 120, 70372 , Stuttgart, ALEMANIA	34
519364	09/09/2022	MERCEDES BENZ	38, 41, 42, 43, 44 y 45	Mercedes-Benz Group AG.	Mercedesstraße 120, 70372 , Stuttgart, ALEMANIA	34
519431	09/09/2022		35, 36, 37, 38, 39, 40, 41, 42, 43, 44 y 45	Mercedes-Benz Group AG.	Mercedesstraße 120, 70372 , Stuttgart, ALEMANIA	34
520417	09/09/2022	MERCEDES	35, 36, 37, 38, 39, 40, 41, 42, 43, 44 y 45	Mercedes-Benz Group AG.	Mercedesstraße 120, 70372 , Stuttgart, ALEMANIA	34
521794	29/09/2022	AVIXIS	5	Galderma Holding S.A.	Zählerweg 10, 6300, ZUG, SUIZA	245
524441	15/09/2022	CORONA	6	MUSTAD HOOFCARE SA	Rue de Gruyères 106, 1630, Bulle, SUIZA	34
525076	16/09/2022	TOMMY HILFIGER	25	TOMMY HILFIGER LICENSING LLC	250 Madison Avenue, 6th Floor, 10017, New York, NY, E. U. DE NORTEAMERICA	194
525871	20/09/2022	AKLIEF	3 y 5	Galderma Holding S.A.	Zählerweg 10, 6300, ZUG, SUIZA	245
529366	16/09/2022		25	TOMMY HILFIGER LICENSING LLC	250 Madison Avenue, 6th Floor, 10017, New York, NY, E. U. DE NORTEAMERICA	194
529369	15/09/2022		14	TOMMY HILFIGER LICENSING LLC	250 Madison Avenue, 6th Floor, 10017, New York, NY, E. U. DE NORTEAMERICA	194
534193	13/09/2022		1, 4, 7 y 9	Mercedes-Benz Group AG.	Mercedesstraße 120, 70372 , Stuttgart, ALEMANIA	34
536113	15/09/2022		25	TOMMY HILFIGER LICENSING LLC	250 Madison Avenue, 6th Floor, 10017, New York, NY, E. U. DE NORTEAMERICA	194
536114	16/09/2022	HILFIGER DENIM	25	TOMMY HILFIGER LICENSING LLC	250 Madison Avenue, 6th Floor, 10017, New York, NY, E. U. DE NORTEAMERICA	194
536115	20/09/2022	TOMMY	25	TOMMY HILFIGER	250 Madison Avenue, 6th Floor,	194

N° Exp.	Resolución	Denominación	Clases	Titular	Dirección	Ag.
				LICENSING LLC	10017, New York, NY, E. U. DE NORTEAMERICA	
536707	13/09/2022		1, 2, 3, 4, 5, 6, 7, 8, 9, 10, 11, 12, 13, 14, 15, 16, 17, 18, 19, 20, 21, 22, 23, 24, 25, 26, 27, 28, 29, 30, 31, 32, 33 y 34	Mercedes-Benz Group AG.	Mercedesstraße 120, 70372 , Stuttgart, ALEMANIA	34
536960	13/09/2022	MERCEDES BENZ	1, 2, 3, 4, 5, 6, 7, 8, 9, 10, 12, 23 y 25	Mercedes-Benz Group AG.	Mercedesstraße 120, 70372 , Stuttgart, ALEMANIA	34
537297	13/09/2022	MERCEDES	1, 2, 3, 4, 5, 6, 7, 8, 9, 10, 12, 13, 14, 15, 16, 17, 18, 19, 20, 21, 22, 23 y 25	Mercedes-Benz Group AG.	Mercedesstraße 120, 70327, Stuttgart, ALEMANIA	34
539144	01/09/2022	JAWA	12 y 25	JAWAUNION s.r.o.	Brodce 46, Týnec nad Sázavou, 257 41, REPUBLICA CHECA	186
539283	13/09/2022	MERCEDES BENZ	1, 4, 7, 9 y 12	Mercedes-Benz Group AG.	Mercedesstraße 120, 70327, Stuttgart, ALEMANIA	34
539425	13/09/2022		1, 2, 3, 4, 5, 6, 7, 8, 9, 10, 11, 12, 13, 14, 15, 16, 17, 18, 19, 20, 21, 22, 23, 24, 25, 26, 27, 28, 29, 30, 31, 32, 33, 34, 35, 36, 37, 38, 39, 40, 41, 42, 43, 44 y 45	Mercedes-Benz Group AG.	Mercedesstraße 120, 70372 , Stuttgart, ALEMANIA	34

CAMBIOS DE DOMICILIO DE FRASES PUBLICITARIAS

N° Exp.	Resolución	Denominación	Clases	Titular	Dirección	Ag.
436071	16/09/2022	TU FUTURO ESTA PRESENTE	36	UNION CAPITAL AFAP S.A.	Solano García 2581, Montevideo, URUGUAY	194

CAMBIOS DE DOMICILIO DESESTIMADOS (Art. 92, D. 34/999)

N° Exp.	Resolución	Denominación	Clases	Titular	Dirección	Ag.
357394	13/09/2022	MB	42	NOGALÍ S.A.	Canstat 2979, Montevideo, Montevideo, URUGUAY	194

CAMBIOS DE DOMICILIO DE PATENTES

N° Exp.	Resolución	Titular	Dirección	Ag.
036534	14/09/2022	WOBEN PROPERTIES GMBH		34
036620	14/09/2022	Tricoya Technologies Ltd.		20
036621	20/09/2022	Tricoya Technologies Ltd.		20

INSCRIPCIONES DE LICENCIAS

N° Exp.	Resolución	Denominación	Clases	Titular	Dirección	Ag.
437058	15/09/2022	AXION ENERGY	39	PAN AMERICAN ENERGY GROUP, S.L.	Arbea Campus Empresarial, Edificio Numero 1, Carretera de Fuencarral a Alcobendas, M - 603, 3.8 Km, Alcobendas, Madrid, ESPAÑA	94
438812	15/09/2022	AXION ENERGY	12	PAN AMERICAN ENERGY GROUO, S.L.	Arbea Campus Empresarial, Edificio Numero 1, Carretera de Fuencarral a Alcobendas, M - 603, 3.8 Km, 28108, ALCOBENDAS, MADRID, ESPAÑA	94
438813	15/09/2022	AXION ENERGY	16	PAN AMERICAN ENERGY GROUP, S.L.	Arbea Campus Empresarial, Edificio Número 1, Carretera de Fuencarral a Alcobendas, M-603, 3.8 Km, 28108, ALCOBENDAS, MADRID, ESPAÑA	94
438814	15/09/2022	AXION ENERGY	25	PAN AMERICAN ENERGY GROUP, S.L.	Arbea Campus Empresarial, Edificio Número 1, Carretera de Fuencarral a Alcobendas, M-603, 3.8 Km, 28108, ALCOBENDAS, MADRID, ESPAÑA	94
438815	15/09/2022	AXION ENERGY	36	PAN AMERICAN ENERGY GROUP, S.L.	Arbea Campus Empresarial, Edificio Número 1, Carretera de Fuencarral a Alcobendas, M-603, 3.8 Km, 28108, ALCOBENDAS,	94

N° Exp.	Resolución	Denominación	Clases	Titular	Dirección	Ag.
					MADRID, ESPAÑA	
438816	15/09/2022	AXION ENERGY	38	PAN AMERICAN ENERGY GROUP, S.L.	Arbea Campus Empresarial, Edificio Número 1, Carretera de Fuencarral a Alcobendas, M-603, 3.8 Km, 28108, ALCOBENDAS, MADRID, ESPAÑA	94
438817	15/09/2022	AXION ENERGY	40	PAN AMERICAN ENERGY GROUP, S.L.	Arbea Campus Empresarial, Edificio Número 1, Carretera de Fuencarral a Alcobendas, M-603, 3.8 Km, 28108, ALCOBENDAS, MADRID, ESPAÑA	94
438818	15/09/2022	AXION ENERGY	41	PAN AMERICAN ENERGY GROUP, S.L.	Arbea Campus Empresarial, Edificio Número 1, Carretera de Fuencarral a Alcobendas, M-603, 3.8 Km, 28108, ALCOBENDAS, MADRID, ESPAÑA	94
438819	15/09/2022	AXION ENERGY	42	PAN AMERICAN ENERGY GROUP, S.L.	Arbea Campus Empresarial, Edificio Número 1, Carretera de Fuencarral a Alcobendas, M-603, 3.8 Km, 28108, Alcobendas, Madrid, ESPAÑA	94
438820	15/09/2022	AXION ENERGY	43	PAN AMERICAN ENERGY GROUP, S.L.	Arbea Campus Empresarial, Edificio Número 1, Carretera de Fuencarral a Alcobendas, M-603, 3.8 Km, 28108, ALCOBENDAS, MADRID, ARGENTINA	94
438821	16/09/2022	AXION ENERGY	44	PAN AMERICAN ENERGY GROUP, S.L.	Arbea Campus Empresarial, Edificio Número 1, Carretera de Fuencarral a Alcobendas, M-603, 3.8 Km, 28108, ALCOBENDAS, MADRID, ESPAÑA	94
438822	16/09/2022	AXION ENERGY	45	PAN AMERICAN ENERGY GROUP, S.L.	Arbea Campus Empresarial, Edificio Número 1, Carretera de Fuencarral a Alcobendas, M-603,	94

N° Exp.	Resolución	Denominación	Clases	Titular	Dirección	Ag.
					3.8 Km, 28108, ALCOBENDAS, MADRID, ESPAÑA	
439887	16/09/2022		45	PAN AMERICAN ENERGY GROUP, S.L.	Arbea Campus Empresarial, Edificio Número 1, Carretera de Fuencarral a Alcobendas, M-603, 3.8 Km, 28108, ALCOBENDAS, MADRID, ESPAÑA	94
439888	16/09/2022		44	PAN AMERICAN ENERGY GROUP, S.L.	Arbea Campus Empresarial, Edificio Número 1, Carretera de Fuencarral a Alcobendas, M-603, 3.8 Km, 28108, ALCOBENDAS, MADRID, ESPAÑA	94
439889	16/09/2022		43	PAN AMERICAN ENERGY GROUP, S.L.	Arbea Campus Empresarial, Edificio Número 1, Carretera de Fuencarral a Alcobendas, M-603, 3.8 Km, 28108, ALCOBENDAS, MADRID, ESPAÑA	94
439890	19/09/2022		42	PAN AMERICAN ENERGY GROUP, S.L.	Arbea Campus Empresarial, Edificio Número 1, Carretera de Fuencarral a Alcobendas, M-603, 3.8 Km, 28108, ALCOBENDAS, MADRID, ESPAÑA	94
439891	19/09/2022		41	PAN AMERICAN ENERGY GROUP, S.L.	Arbea Campus Empresarial, Edificio Número 1, Carretera de Fuencarral a Alcobendas, M-603, 3.8 Km, 28108, ALCOBENDAS, MADRID, ESPAÑA	94
439892	19/09/2022		40	PAN AMERICAN ENERGY GROUP, S.L.	Arbea Campus Empresarial, Edificio Número 1, Carretera de Fuencarral a Alcobendas, M-603, 3.8 Km, 28108, ALCOBENDAS, MADRID, ESPAÑA	94
439893	19/09/2022		39	PAN AMERICAN ENERGY GROUP, S.L.	Arbea Campus Empresarial, Edificio Número 1, Carretera de	94

N° Exp.	Resolución	Denominación	Clases	Titular	Dirección	Ag.
					Fuencarral a Alcobendas, M-603, 3.8 Km, 28108, ALCOBENDAS, MADRID, ESPAÑA	
439894	19/09/2022		38	PAN AMERICAN ENERGY GROUP, S.L.	Arbea Campus Empresarial, Edificio Número 1, Carretera de Fuencarral a Alcobendas, M-603, 3.8 Km, 28108, ALCOBENDAS, MADRID, ESPAÑA	94
439895	19/09/2022		37	PAN AMERICAN ENERGY GROUP, S.L.	Arbea Campus Empresarial, Edificio Número 1, Carretera de Fuencarral a Alcobendas, M-603, 3.8 Km, 28108, ALCOBENDAS, MADRID, ESPAÑA	94
439896	19/09/2022		36	PAN AMERICAN ENERGY GROUP, S.L.	Arbea Campus Empresarial, Edificio Número 1, Carretera de Fuencarral a Alcobendas, M-603, 3.8 Km, 28108, ALCOBENDAS, MADRID, ESPAÑA	94
439897	19/09/2022		35	PAN AMERICAN ENERGY GROUP, S.L.	Arbea Campus Empresarial, Edificio Número 1, Carretera de Fuencarral a Alcobendas, M-603, 3.8 Km, 28108, ALCOBENDAS, MADRID, ESPAÑA	94
439898	19/09/2022		25	PAN AMERICAN ENERGY GROUP, S.L.	Arbea Campus Empresarial, Edificio Número 1, Carretera de Fuencarral a Alcobendas, M-603, 3.8 Km, 28108, ALCOBENDAS, MADRID, ESPAÑA	94
439899	19/09/2022		16	PAN AMERICAN ENERGY GROUP, S.L.	Arbea Campus Empresarial, Edificio Número 1, Carretera de Fuencarral a Alcobendas, M-603, 3.8 Km, 28108, ALCOBENDAS, MADRID, ESPAÑA	94
439900	19/09/2022		12	PAN AMERICAN	Arbea Campus Empresarial,	94

N° Exp.	Resolución	Denominación	Clases	Titular	Dirección	Ag.
				ENERGY GROUP, S.L	Edificio Número 1, Carretera de Fuencarral a Alcobendas, M-603, 3.8 Km, 28108, ALCOBENDAS, MADRID, ESPAÑA	
439901	19/09/2022		4	PAN AMERICAN ENERGY GROUP, S.L	Arbea Campus Empresarial, Edificio Número 1, Carretera de Fuencarral a Alcobendas, M-603, 3.8 Km, 28108, ALCOBENDAS, MADRID, ESPAÑA	94
439902	19/09/2022	AXION ENERGY	45	PAN AMERICAN ENERGY GROUP, S.L.	Arbea Campus Empresarial, Edificio Número 1, Carretera de Fuencarral a Alcobendas, M-603, 3.8 Km, 28108, ALCOBENDAS, MADRID, ESPAÑA	94
439903	19/09/2022	AXION ENERGY	44	PAN AMERICAN ENERGY GROUP, S.L.	Arbea Campus Empresarial, Edificio Número 1, Carretera de Fuencarral a Alcobendas, M-603, 3.8 Km, 28108, ALCOBENDAS, MADRID, ESPAÑA	94
439904	19/09/2022	AXION ENERGY	43	PAN AMERICAN ENERGY GROUP, S.L.	Arbea Campus Empresarial, Edificio Número 1, Carretera de Fuencarral a Alcobendas, M-603, 3.8 Km, 28108, ALCOBENDAS, MADRID, ESPAÑA	94
439905	19/09/2022	AXION ENERGY	42	PAN AMERICAN ENERGY GROUP, S.L	Arbea Campus Empresarial, Edificio Número 1, Carretera de Fuencarral a Alcobendas, M-603, 3.8 Km, 28108, ALCOBENDAS, MADRID, ESPAÑA	94
439906	19/09/2022	AXION ENERGY	41	PAN AMERICAN ENERGY GROUP, S.L.	Arbea Campus Empresarial, Edificio Número 1, Carretera de Fuencarral a Alcobendas, M-603, 3.8 Km, 28108, ALCOBENDAS, MADRID, ESPAÑA	94

N° Exp.	Resolución	Denominación	Clases	Titular	Dirección	Ag.
439907	19/09/2022	AXION ENERGY	40	PAN AMERICAN ENERGY GROUP, S.L.	Arbea Campus Empresarial, Edificio Número 1, Carretera de Fuencarral a Alcobendas, M-603, 3.8 Km, 28108, ALCOBENDAS, MADRID, ESPAÑA	94
439908	19/09/2022	AXION ENERGY	39	PAN AMERICAN ENERGY GROUP, S.L.	Arbea Campus Empresarial, Edificio Número 1, Carretera de Fuencarral a Alcobendas, M-603, 3.8 Km, 28108, ALCOBENDAS, MADRID, ESPAÑA	94
439909	20/09/2022	AXION ENERGY	38	PAN AMERICAN ENERGY GROUP, S.L.	Arbea Campus Empresarial, Edificio Número 1, Carretera de Fuencarral a Alcobendas, M-603, 3.8 Km., 28108, Alcobendas, Madrid , ESPAÑA	94
439910	20/09/2022	AXION ENERGY	37	PAN AMERICAN ENERGY GROUP, S.L.	Arbea Campus Empresarial, Edificio Número 1, Carretera de Fuencarral a Alcobendas, M-603, 3.8 Km., 28108, Alcobendas, Madrid , ESPAÑA	94
439911	20/09/2022	AXION ENERGY	36	PAN AMERICAN ENERGY GROUP, S.L.	Arbea Campus Empresarial, Edificio Número 1, Carretera de Fuencarral a Alcobendas, M-603, 3.8 Km., 28108, Alcobendas, Madrid, ESPAÑA	94
439912	20/09/2022	AXION ENERGY	35	PAN AMERICAN ENERGY GROUP, S.L.	Arbea Campus Empresarial, Edificio Número 1, Carretera de Fuencarral a Alcobendas, M-603, 3.8 Km., 28108, Alcobendas, Madrid, ESPAÑA	94
439913	20/09/2022	AXION ENERGY	25	PAN AMERICAN ENERGY GROUP, S.L.	Arbea Campus Empresarial, Edificio Número 1, Carretera de Fuencarral a Alcobendas, M-603, 3.8 Km., 28108, Alcobendas,	94

N° Exp.	Resolución	Denominación	Clases	Titular	Dirección	Ag.
					Madrid, ESPAÑA	
439914	20/09/2022	AXION ENERGY	16	PAN AMERICAN ENERGY GROUP, S.L.	Arbea Campus Empresarial, Edificio Número 1, Carretera de Fuencarral a Alcobendas, M-603, 3.8 Km., 28108, Alcobendas, Madrid, ESPAÑA	94
439915	20/09/2022	AXION ENERGY	12	PAN AMERICAN ENERGY GROUP, S.L.	Arbea Campus Empresarial, Edificio Número 1, Carretera de Fuencarral a Alcobendas, M-603, 3.8 Km., 28108, Alcobendas, Madrid, ESPAÑA	94
439916	20/09/2022	AXION ENERGY	4	PAN AMERICAN ENERGY GROUP, S.L.	Arbea Campus Empresarial, Edificio Número 1, Carretera de Fuencarral a Alcobendas, M-603, 3.8 Km., 28108, Alcobendas, Madrid, ESPAÑA	94
442080	20/09/2022	AXION TV	38	PAN AMERICAN ENERGY GROUP, S.L.	Arbea Campus Empresarial, Edificio Número 1, Carretera de Fuencarral a Alcobendas, M-603, 3.8 Km., 28108, Alcobendas, Madrid, ESPAÑA	94
442081	21/09/2022	AXION MUSIC	41	PAN AMERICAN ENERGY GROUP, S.L.	Arbea Campus Empresarial, Edificio Número 1, Carretera de Fuencarral a Alcobendas, M-603, 3.8 Km., 28108, Alcobendas, Madrid, ESPAÑA	94
442082	21/09/2022	AXION SPORT	41	PAN AMERICAN ENERGY GROUP, S.L.	Arbea Campus Empresarial, Edificio Número 1, Carretera de Fuencarral a Alcobendas, M-603, 3.8 Km., 28108, Alcobendas, Madrid, ESPAÑA	94
442083	21/09/2022	AXION LIVE	42	PAN AMERICAN ENERGY GROUP, S.L.	Arbea Campus Empresarial, Edificio Número 1, Carretera de Fuencarral a Alcobendas, M-603,	94

N° Exp.	Resolución	Denominación	Clases	Titular	Dirección	Ag.
					3.8 Km., 28108, Alcobendas, Madrid, ESPAÑA	
442084	21/09/2022	AXION ART	41	PAN AMERICAN ENERGY GROUP, S.L.	Arbea Campus Empresarial, Edificio Número 1, Carretera de Fuencarral a Alcobendas, M-603, 3.8 Km., 28108, Alcobendas, Madrid, ESPAÑA	94
442085	21/09/2022	AXION SHOP	35	PAN AMERICAN ENERGY GROUP, S.L.	Arbea Campus Empresarial, Edificio Número 1, Carretera de Fuencarral a Alcobendas, M-603, 3.8 Km., 28108, Alcobendas, Madrid , ESPAÑA	94
442086	21/09/2022	AXION DIGITAL	38	PAN AMERICAN ENERGY GROUP, S.L.	Arbea Campus Empresarial, Edificio Número 1, Carretera de Fuencarral a Alcobendas, M-603, 3.8 Km., 28108, Alcobendas, Madrid, ESPAÑA	94
444987	21/09/2022	AXION ENERGY	4, 35, 37 y 42	PAN AMERICAN ENERGY GROUP, S.L.	Arbea Campus Empresarial, Edificio Número 1, Carretera de Fuencarral a Alcobendas, M-603, 3.8 Km., 28108, Alcobendas, Madrid , ESPAÑA	94
447920	21/09/2022	AXION ENERGY AXION ENERGY AXION ENERGY	4, 37 y 39	PAN AMERICAN ENERGY GROUP, S.L.	Arbea Campus Empresarial, Edificio Número 1, Carretera de Fuencarral a Alcobendas, M-603, 3.8 Km., 28108, Alcobendas, Madrid, ESPAÑA	94
449082	21/09/2022	AXION SPOT	35, 37, 39 y 43	PAN AMERICAN ENERGY GROUP, S.L.	Arbea Campus Empresarial, Edificio Número 1, Carretera de Fuencarral a Alcobendas, M-603, 28108, Alcobendas, Madrid, ESPAÑA	94
449083	21/09/2022	AXION SPOT	4	PAN AMERICAN ENERGY GROUP, S.L.	Arbea Campus Empresarial, Edificio Número 1, Carretera de	94

N° Exp.	Resolución	Denominación	Clases	Titular	Dirección	Ag.
					Fuencarral a Alcobendas, M-603, 3.8 Km., 28108, Alcobendas, Madrid , ESPAÑA	
449084	21/09/2022	SPOT CAFÉ	43	PAN AMERICAN ENERGY GROUP, S.L.	Arbea Campus Empresarial, Edificio Número 1, Carretera de Fuencarral a Alcobendas, M-603, 3.8 Km., 28108, Alcobendas, Madrid, ESPAÑA	94
450676	22/09/2022	SPOT CAFE	4, 35, 37, 39 y 43	PAN AMERICAN ENERGY GROUP, S.L.	Arbea Campus Empresarial, Edificio Número 1, Carretera de Fuencarral a Alcobendas, M-603, 3.8 Km., 28108, Alcobendas, Madrid, ESPAÑA	94
451921	22/09/2022	AXION ENERGY AXION	4, 35, 37 y 39	PAN AMERICAN ENERGY GROUP, S.L.	Arbea Campus Empresarial, Edificio Número 1, Carretera de Fuencarral a Alcobendas, M-603, 3.8 Km, 28108, ALCOBENDAS, MADRID, ESPAÑA	94
451922	22/09/2022	AXION ENERGY AXION	4, 35, 37 y 39	PAN AMERICAN ENERGY GROUP, S.L.	Arbea Campus Empresarial, Edificio Número 1, Carretera de Fuencarral a Alcobendas, M-603, 3.8 Km., 28108, Alcobendas, Madrid , ESPAÑA	94
451923	22/09/2022	AXION ENERGY AXION	4, 35, 37 y 39	PAN AMERICAN ENERGY GROUP, S.L.	Arbea Campus Empresarial, Edificio Número 1, Carretera de Fuencarral a Alcobendas, M-603, 3.8 Km., 28108, Alcobendas, Madrid, ESPAÑA	94
457992	22/09/2022	SPOT	4, 35, 37, 39 y 43	PAN AMERICAN ENERGY GROUP, S.L.	Arbea Campus Empresarial, Edificio Número 1, Carretera de Fuencarral a Alcobendas, M-603, 3.8 Km., 28108, Alcobendas, Madrid, ESPAÑA	94
501017	15/09/2022	CLARO REVESTIMIENTOS	35	UNIGRES SA	camino Fenix 4275, montevideo,	34

N° Exp.	Resolución	Denominación	Clases	Titular	Dirección	Ag.
					montevideo, montevideo, URUGUAY	
501017	15/09/2022	CLARO REVESTIMIENTOS	35	UNIGRES SA	camino Fenix 4275, montevideo, montevideo, montevideo, URUGUAY	34
501017	15/09/2022	CLARO REVESTIMIENTOS	35	UNIGRES SA	camino Fenix 4275, montevideo, montevideo, montevideo, URUGUAY	34

INSCRIPCIONES DE LICENCIAS DE FRASES PUBLICITARIAS

N° Exp.	Resolución	Denominación	Clases	Titular	Dirección	Ag.
501949	22/09/2022	SUPERA LOS LIMITES	4 y 37	PAN AMERICAN ENERGY GROUP, S.L.	Arbea Campus Empresarial, Edificio Número 1, Carretera de Fuencarral a Alcobendas, M-603, 3,8 Km, Alcobendas, 28108, Madrid, Madrid, ESPAÑA	94
501950	22/09/2022	VIVI LA DIFERENCIA	4 y 37	PAN AMERICAN ENERGY GROUP, S.L.	Arbea Campus Empresarial, Edificio Número 1, Carretera de Fuencarral a Alcobendas, M-603, 3,8 Km, Alcobendas, 28108, Madrid, Madrid, ESPAÑA	94

INSCRIPCIONES DE PRENDAS

N° Exp.	Resolución	Denominación	Clases	Titular	Dirección	Ag.
440120	09/09/2022	AAIRPASS	39	AMERICAN AIRLINES, INC.	1 Skyview Drive MD 8B503, 76155, Fort Worth, Texas, E. U. DE NORTEAMERICA	136
442306	09/09/2022		39	AMERICAN AIRLINES, INC.	1 Skyview Drive MD 8B503, 76155, Fort Worth, Texas, E. U. DE NORTEAMERICA	136
442307	09/09/2022		35 y 39	AMERICAN AIRLINES, INC.	1 Skyview Drive MD 8B503, 76155, Fort Worth, Texas, E. U.	136

N° Exp.	Resolución	Denominación	Clases	Titular	Dirección	Ag.
					DE NORTEAMERICA	
461468	12/09/2022	AMERICAN AIRLINES	35, 37 y 39	AMERICAN AIRLINES, INC.	1 Skyview Drive MD 8B503, 76155, Fort Worth, Texas, E. U. DE NORTEAMERICA	136
471806	12/09/2022	AMERICAN	35 y 39	American Airlines, Inc.	1 Skyview Drive, MD 8B503, 76155, Fort Worth, Texas, E. U. DE NORTEAMERICA	136
487835	12/09/2022	AMERICAN AIRLINES	25, 28, 36, 38, 41 y 43	AMERICAN AIRLINES, INC.	1 Skyview Drive, MD 8B503, 76155, Fort Worth, Texas, E. U. DE NORTEAMERICA	136
487836	12/09/2022		25, 28, 35, 36, 38, 39, 41 y 43	AMERICAN AIRLINES, INC.	1 Skyview Drive, MD 8B503, 76155, Fort Worth, Texas, E. U. DE NORTEAMERICA	136
502753	12/09/2022	TWA	14	American Airlines, Inc.	1 Skyview Drive, MD 8B503, 76155, Fort Worth, Texas, E. U. DE NORTEAMERICA	136
505162	12/09/2022	TWA	14	American Airlines, Inc.	1 Skyview Drive, MD 8B503, 76155, Fort Worth, Texas, E. U. DE NORTEAMERICA	136

MODIFICACIONES DE PRENDAS

N° Exp.	Resolución	Denominación	Clases	Titular	Dirección	Ag.
427744	22/09/2022	FIT	32	MISTERIL S.A.	Rincón 454, Escritorio 316, Montevideo, Montevideo, URUGUAY	205
431672	16/09/2022	EL OBSERVADOR	16 y 41	MICROCOSMOS S.A.	Ejido 1275, Montevideo, Montevideo, URUGUAY	205
441095	22/09/2022	RINDE DOS 2 LITROS	32	MISTERIL S.A.	Av. Brasil 2697/002, Montevideo, Montevideo, URUGUAY	176
445715	16/09/2022	EL OBSERVADOR +	9 y 41	MICROCOSMOS S.A.	Cuareim 2052, MONTEVIDEO, URUGUAY	205
450463	16/09/2022	O	9, 16 y 41	MICROCOSMOS S.A.	Cuareim 2052, MONTEVIDEO, URUGUAY	205

N° Exp.	Resolución	Denominación	Clases	Titular	Dirección	Ag.
					URUGUAY	
450464	16/09/2022	O EL OBSERVADOR	9, 16 y 41	MICROCOSMOS S.A.	Cuareim 2052, Montevideo, Montevideo, URUGUAY	205
521313	16/09/2022	OBSERVA	35 y 38	MICROCOSMOS S.A.	Cuareim 2052, Montevideo, Montevideo, Montevideo, URUGUAY	218

INSCRIPCIONES DE RENUNCIAS TOTALES

N° Exp.	Resolución	Denominación	Clases	Titular	Dirección	Ag.
480194	17/08/2022	DOLTER	29	RODOLFO SELLANES	Figuroa 421, San José de Mayo, San José, URUGUAY	220
485807	08/09/2022	MACARENA	41	CARLOS VALDEZ	Isla De Flores 1530, Montevideo, Montevideo, URUGUAY	
507834	30/09/2022	TOM'S OF MAINE WICKED FRESH	3	Tom's of Maine, Inc.	2 Storer Street, Suite 302., Kennebunk., 04043, Maine, Maine, E. U. DE NORTEAMERICA	201

INSCRIPCIONES DE RENUNCIAS PARCIALES

N° Exp.	Resolución	Denominación	Clases	Titular	Dirección	Ag.
415047	12/09/2022	LATAM AIRLINES	9, 12, 16, 25, 35, 36, 37, 38, 39, 41, 42, 43 y 45	LATAM AIRLINES GROUP S.A y LUIS FELIPE CLARO SWINBURN	Avda. Presidente Riesco 5711, Piso 19, Las Condes, Santiago , CHILE y Apoquindo 3721 Piso 13, Las Condes, Santiago, CHILE	201

RESOLUCIONES DE RECURSOS, DNPI

N° Exp	Resolución	Marca	Clases	Titular	Ag.
493270	02/09/2022	WABI (mixta) / ELIS CARLA PARODI CAYafa	35 (Denegada) y 25 (Denegada)		
495685	14/09/2022	JUVENTUS / Juventus Football Club	28 (Concedida S/D),		245

N° Exp	Resolución	Marca	Clases	Titular	Ag.
		S.p.A	25 (Concedida S/D), 16 (Concedida S/D), 9 (Concedida S/D) y 41 (Denegada S/D)		
505575	05/09/2022	HUMANIZA - JOSEFINA / Florencia KRALL CURUCHAGA	44 (Concedida), 41 (Concedida), 16 (Concedida) y 9 (Concedida)		94

RESOLUCIONES DE RECURSOS DE DISEÑOS INDUSTRIALES, DNPI

N° Exp	Resolución	Marca	Clases	Titular	Ag.
004838	09/09/2022	/ Apple Inc.			216

RESOLUCIONES DE REIVINDICACIONES

N° Exp	Resolución	Marca	Clases	Titular	Ag.
524834	30/09/2022	DELKO / DELKO ALIMENTOS SRL	31 (Pendiente)		28

RESOLUCIONES DE PATENTES, CONCEDIDAS

N° Exp	Resolución	Título	Titular	Ag.
No. 34453	05/09/2022	MOLÉCULAS DE UNIÓN PARA BCMA Y CD3	AMGEN INC. y AMGEN RESEARCH (MUNICH) GMBH	34
No. 34912	19/09/2022	COMPUESTOS DE INDOL COMO ANTAGONISTAS DEL RECEPTOR DE 5-HT3	TAKEDA PHARMACEUTICAL COMPANY LIMITED	94
No. 34913	05/09/2022	“COMPOSICIONES FARMACÉUTICAS INYECTABLES QUE CONTIENEN PENETAMATO Y SUS USOS”	BAYER NEW ZEALAND LIMITED	216
No. 34938	05/09/2022	COMPOSICIONES HERBICIDAS QUE COMPRENDEN EL BENCIL ÉSTER DEL ÁCIDO 4-AMINO-3-CLORO-5- FLÚOR-6-(4-CLORO-2-FLÚOR-3-METOXI- FENIL)PIRIDINA-2-CARBOXÍLICO Y	DOW AGROSCIENCES LLC	165

N° Exp	Resolución	Título	Titular	Ag.
		TRIAZOLOPIRIMIDIN-SULFONAMIDAS, Y MÉTODO PARA CONTROLAR LA VEGETACIÓN INDESEABLE.		
No. 34940	13/09/2022	COMPOSICIONES HERBICIDAS QUE COMPRENDEN EL BENCIL ÉSTER DEL ÁCIDO 4-AMINO-3-CLORO-5-FLÚOR-6-(4-CLORO-2-FLÚOR-3-METOXI-FENIL)PIRIDINA-2-CARBOXÍLICO Y HERBICIDAS QUE INHIBEN LA SÍNTESIS DE LOS ÁCIDOS GRASOS DE CADENA MUY LARGA (VLCFA) Y DE ÁCIDOS GRASOS/LÍPIDOS, Y MÉTODO PARA CONTROLAR LA VEGETACIÓN INDESEABLE	DOW AGROSCIENCES LLC	165
No. 34941	13/09/2022	COMPOSICIONES HERBICIDAS QUE COMPRENDEN EL BENCIL ÉSTER DEL ÁCIDO 4-AMINO-3-CLORO-5-FLÚOR-6-(4-CLORO-2-FLÚOR-3-METOXI-FENIL)PIRIDINA-2-CARBOXÍLICO Y UNA IMIDAZOLINONA, Y MÉTODO PARA CONTROLAR LA VEGETACIÓN INDESEABLE	DOW AGROSCIENCES LLC	165
No. 35062	05/09/2022	MÉTODO PARA CONTROLAR VEGETACIÓN INDESEADA QUE COMPRENDE HERBICIDAS AMINOCICLOPIRACLOR Y AMINOPIRALID CON ACTIVIDAD SINÉRGICA	Corteva Agriscience LLC.	20
No. 35122	05/09/2022	PROCESO DE PRODUCCIÓN EN LÍNEA PARA UNA CAPA DE CARTÓN	STORA ENSO OYJ y WETEND TECHNOLOGIES LTD	192
No. 35188	05/09/2022	MÉTODO PARA EL CONTROL SINÉRGICO DE LA VEGETACIÓN NO DESEADA CON AMINOCICLOPIRACLOR Y ÁCIDO 2,4-DICLOROFENOXIACÉTICO (2,4-D).	DOW AGROSCIENCES LLC	165
No. 35342	05/09/2022	MÉTODO Y SISTEMA PARA EL CONTROL DE UN DISPOSITIVO DE RECEPCIÓN DE USUARIO POR EL USO DE COMANDOS DE VOZ	Vrio Corp.	218
No. 35352	19/09/2022	“Métodos para preparar composiciones de mezcla de tanque acuosas que comprenden glifosato y dicamba, y	Monsanto Technology LLC	20

N° Exp	Resolución	Título	Titular	Ag.
		composiciones preparadas mediante dichos métodos”.		
No. 35433	05/09/2022	“4-AMINO-6-(HETEROCÍCLICO)PICOLINATOS Y 6-AMINO-2-(HETEROCÍCLICO)PIRIMIDINA-4-CARBOXILATOS Y SU USO COMO HERBICIDAS”.	Corteva Agriscience LLC	20
No. 35565	13/09/2022	MÉTODO Y EQUIPO PARA PRODUCIR CELULOSA NANOFIBRILAR	UPM-Kymmene Corporation	94
No. 35611	05/09/2022	CAMARA TORSIONAL CON EXTRACCIÓN CONTINUA DE CENIZAS Y FUNCIONAMIENTO CONTINUO	JULIO BERKES S.A	34
No. 35634	19/09/2022	MÉTODO PARA TRATAR EFLUENTES Y AGUAS DEL PROCESO	UPM-Kymmene Corporation	94
No. 35659	27/09/2022	TUBO FLEXIBLE SUBMARINO	PRYSMIAN S.p.A.	34
No. 35679	27/09/2022	Sistemas y métodos para solicitar una comunicación	Vrio Corp.	218
No. 39500	19/09/2022	COMPOSICIONES VETERINARIAS ORALES PARASITICIDAS QUE COMPRENDEN AGENTES ACTIVOS DE ACCIÓN SISTÉMICA, MÉTODOS Y USOS DE LAS MISMAS	Boehringer Ingelheim Animal Health USA Inc.	94

RESOLUCIONES DE DISEÑOS INDUSTRIALES, CONCEDIDAS

N° Exp	Resolución	Título	Titular	Ag.
No. 4856	05/09/2022	TIENDA	DISA HOLDING ENERGÉTICO, S.L.U.	144
No. 4871	05/09/2022	AUDÍFONO Y PAR DE AUDÍFONOS	APPLE INC.	216
No. 4874	05/09/2022	LÁMPARA	SACKIT ApS	216
No. 4875	13/09/2022	BOTELLA DE PERFUME	ANTONIO PUIG, S.A.	34
No. 4878	27/09/2022	CONFIGURACIÓN APLICADA A BOMBILLA DE MATE	PMI South America Consumer Goods, Ltda.	211

RESOLUCIONES DE MODELOS DE UTILIDAD, CONCEDIDAS

N° Exp	Resolución	Título	Titular	Ag.
U-4738	27/09/2022	PILASTRA DE HORMIGÓN	Luis Acosta	
U-4799	13/09/2022	DESAGÜE PLUVIAL PREFABRICADO	NICOLL URUGUAY S.A.	218

N° Exp	Resolución	Título	Titular	Ag.
U-4837	13/09/2022	PEINE PARA PEDICULOSIS CON BARRIDO BIDIRECCIONAL	JORGE REINALDO BURCHAKCHI y JUAN MARTÍN SANZ	205

RESOLUCIONES DE PATENTES, DESESTIMADAS

N° Exp	Resolución	Título	Titular	Ag.
No. 34378	05/09/2022	Proceso para producir peróxido de hidrógeno	SOLVAY SA	216
No. 34968	13/09/2022	“MÉTODOS PARA EL MEJORAMIENTO DE LAS PROPIEDADES ORGANOLÉPTICAS DE BEBIDAS FERMENTADAS Y NO FERMENTADAS DE MOSTO”.	DANSTAR FERMENT AG	20
No. 35101	19/09/2022	Composiciones plaguicidas que comprenden novalurón y piriproxifeno y métodos para el control de plagas de invertebrados.	MAKHTESHIM CHEMICAL WORKS LTD.	165
No. 35253	19/09/2022	COMPUESTO FARMACÉUTICO PARA LA PREVENCIÓN Y EL TRATAMIENTO DE UN TRASTORNO O UNA ENFERMEDAD COGNITIVOS, NEURODEGENERATIVOS O NEURONALES	CESA ALLIANCE S.A.	179
No. 35310	05/09/2022	PLANTAS LNK-TRANSGÉNICAS	CONSEJO NACIONAL DE INVESTIGACIONES CIENTIFICAS Y TECNICAS (CONICET) y FUNDACION INSTITUTO LELOIR	34
No. 35522	05/09/2022	PROCESO NOVEDOSO PARA ROMPIMIENTO, REAGRUPACION MOLECULAR Y OPTIMIZACION Y AUMENTO DE VOLUMEN DE COMBUSTIBLE MEDIANTE CAVITACION HIDRODINAMICA Y ALTA PRESION CON LA ADICION DE AGUA Y OTROS ADITIVOS	GONZÁLEZ, CARLOS JOSÉ	34
No. 35532	13/09/2022	COMPUESTOS DE UNIÓN A NHE3 Y MÉTODOS PARA INHIBIR EL TRANSPORTE DE FOSFATO	Ardelyx Inc	216
No. 35541	19/09/2022	Composición de ácidos grasos omega-3, zinc y hierro para el tratamiento del trastorno por déficit de atención e	Siegfried Rhein S.A. de C.V.	18

N° Exp	Resolución	Título	Titular	Ag.
		hiperactividad (TDAH)		
No. 35573	19/09/2022	DERIVADOS DE SULFAMOILPIRROLAMIDA Y SU USO COMO MEDICAMENTOS PARA EL TRATAMIENTO DE LA HEPATITIS B	JANSSEN SCIENCES IRELAND UC	192
No. 35754	05/09/2022	COFORMULACIONES DE BIFENTRINA CON AGENTES DE PROTECCIÓN DE CULTIVOS DE ALTO PUNTO DE FUSIÓN PARA USO CON FERTILIZANTES LÍQUIDOS	FMC CORPORATION	189
No. 35778	19/09/2022	COMPOSICIÓN ANTITRANSPIRANTE MEJORADA	Riemann Trading ApS	34
No. 39340	19/09/2022	ANTICUERPOS PARA hANGPTL3, COMPOSICIONES FARMACÉUTICAS QUE LOS CONTIENEN, Y SUS USOS	REGENERON PHARMACEUTICALS, INC.	192

RESOLUCIONES DE MODELOS DE UTILIDAD, DESESTIMADAS

N° Exp	Resolución	Título	Titular	Ag.
U-4688	13/09/2022	GRINFA-MORSA POR DOBLE BOCA EN LINEA Y DESCENTRADAS	EDUARDO MEDINA YLLA	

RESOLUCIONES DE PATENTES, ABANDONADAS

N° Exp	Resolución	Título	Titular	Ag.
No. 34379	13/09/2022	UTILIZACIÓN DE LA ENERGÍA CINÉTICA PARA GENERAR ENERGÍA ELÉCTRICA A TRAVÉS DE COLECTORES DE ENERGÍA	JULIO CESAR FAR BRITOS, NADIA ABIGAIL FAR FONSECA, CESAR CAYETANO FAR	
No. 34898	05/09/2022	HIDROELÉCTRICA MARÍTIMA	MANUEL FALQUE	
No. 35053	19/09/2022	Un complemento para el crecimiento destinado a que el cultivo y la cría de ganado inocuos para el medio ambiente aumenten el rendimiento de los cultivos y el ganado	Yong Guk KIM; Tae Hyun KIM y Jae Sung PARK	94
No. 35386	05/09/2022	SENSOR BIOMÉTRICO PARA DISTRIBUCIÓN DIFERENCIAL EN SUPERFICIE, DE INSUMOS AGRÍCOLAS, VÍA ECUACIÓN VARIABLE	PABLO ALEJANDRO BERGER RICCA y ANDRÉS GUSTAVO BERGER RICCA	

N° Exp	Resolución	Título	Titular	Ag.
		PARAMETRIZADA POR DATOS GEO REFERENCIADOS		
No. 35409	05/09/2022	2-AZABICICLOS SUSTITUIDOS Y SU USO COMO MODULADORES DEL RECEPTOR DE OREXINA	JANSSEN PHARMACEUTICA NV	192
No. 35494	13/09/2022	ALMOHADA ORTOPEDICA EN "L" INVERTIDA Y FUNDA CON BANDAS DE SUJECION POR CONTACTO PARA REPOSO EN DECUBITO LATERAL	VIVIANA NELLY VITELLI	
No. 35523	13/09/2022	DISPOSITIVO Y PROCEDIMIENTO PARA LA GENERACIÓN DE ENERGÍA ELÉCTRICA	ARION TECNOLOGIA BRASIL - GESTÃO DE ATIVOS S/A	34
No. 35546	13/09/2022	Elemento y Método Didáctico y Psicopedagógico (FUTTDAM)	Miguel Angel Solari Noble	216
No. 35576	13/09/2022	MISS MEDIO AMBIENTE	MARIA CAROLINE DA SILVEIRA DIAZ	
No. 35591	13/09/2022	COMPOSICIÓN BIOCIDA PARA EL CONTROL DE PLAGAS Y ESPECIES INVASORAS, PRODUCTOS DE REVESTIMIENTO Y SU USO	Maria Pilar MATEO HERRERO	165
No. 35720	13/09/2022	PROCESO DE FABRICACIÓN DE TANQUES DE COMBUSTIBLE EN CHAPAS DE ACEROS DE MEDIANA O ALTA RESISTENCIA CON REVESTIMIENTO ORGANOMETÁLICO, EXTREMOS BRIDADOS Y TUBOS DE ENTRADA, RESPIRADERO Y TUBO DE DESAHOGO CLAVADOS	AETHRA SISTEMAS AUTOMOTIVOS S.A.	180
No. 35721	13/09/2022	TANQUE DE COMBUSTIBLE DE ALTA PRESIÓN FABRICADO EN CHAPAS DE ACEROS DE ALTA RESISTENCIA O ACEROS AVANZADOS DE ALTA RESISTENCIA CON REVESTIMIENTO ORGANOMETÁLICO	AETHRA SISTEMAS AUTOMOTIVOS S.A.	180
No. 35722	13/09/2022	SISTEMA INTEGRADO DE VENTILACIÓN EN TANQUE DE COMBUSTIBLE, METÁLICO Y CON REVESTIMIENTO ORGANOMETÁLICO	AETHRA SISTEMAS AUTOMOTIVOS S.A.	180
No. 35781	27/09/2022	INHIBIDORES DE KRAS G12C.	ARAXES PHARMA LLC	165
No. 36501	27/09/2022	COMPOSICIONES MICROENCAPSULADAS INHIBIDORAS DE LA NITRIFICACIÓN	DOW AGROSCIENCES LLC	20

N° Exp	Resolución	Título	Titular	Ag.
No. 38952	13/09/2022	AMIDAS DE 4-ARIL-1,4-DIHIDRO-1,6-NAFTIRIDINA SUSTITUIDAS Y COMPOSICIONES FARMACÉUTICAS QUE LAS CONTIENEN	BAYER INTELLECTUAL PROPERTY GMBH	216
No. 38953	13/09/2022	AMIDAS DE 4-ARIL-1,4-DIHIDRO-1,6-NAFTIRIDINA SUSTITUIDAS Y COMPOSICIONES FARMACÉUTICAS QUE LAS CONTIENEN	BAYER INTELLECTUAL PROPERTY GMBH	216
No. 39448	05/09/2022	FORMAS CRISTALINAS DE UN COMPUESTO FARMACÉUTICO	Azafaros B.V.	211

RESOLUCIONES DE DISEÑOS INDUSTRIALES, ABANDONADAS

N° Exp	Resolución	Título	Titular	Ag.
No. 4873	19/09/2022	Vehiculo	MARIA JOSE BIGLIANTE	

En virtud de la discrepancia que surge en la actualidad entre la fecha de validez de las resoluciones en los sistemas IPAS y [PAMP](#) con la que surge del Boletín de la DNPI, debe dejarse constancia que la fecha de validez de la resolución correspondiente es la que surge de los sistema IPAS y [PAMP](#), fecha de firma de la misma.

NOTIFICACIONES DE ASESORÍA

De conformidad con lo establecido por el numeral 4° del artículo 80 de la Ley 17.011 del 25 de setiembre de 1998 y artículo 87 del decreto N° 34/999 del 3 de febrero de 1999, se notifica a quien se cita a continuación, por razones de su interés, debe presentarse en sección Recursos de la Dirección Nacional de Propiedad Industrial, sita en la calle Rincón 723, 3er. Piso.

MARCA	VIEJO URBAN
ACTA	484168
NOMBRE	ÁLVARO ZALCMAN
NOTIFICACION	<p>VISTO: La solicitud de Registro de la Marca “VIEJO URBAN” (mixta), Acta N° 484.168, solicitada a favor de “ÁLVARO ZALCMAN” de URUGUAY, para proteger los productos y los servicios de las clases internacionales 25 y 35.-</p> <p>RESULTANDO: I) Se deduce una oposición de tercero, por parte de “CLIFPARK S.A.” de URUGUAY, en base a los registros de las marcas “URBAN CULTURE APPAREL COMPANY” (mixta) Acta N° 443.375, “THE URBAN HAUS GARMENTS & PROVISIONS THE URBAN HAUS HOUSE OF BRANDS” (mixta) Acta N° 442.936 y “URBAN COOLTURE” (mixta) Acta N° 404.778, todas para la totalidad de los productos y de los servicios comprendidos en las clases internacionales 25 y 35.-</p> <p>II) División Legal dictamina que correspondería CONCEDER el presente registro, por los argumentos que expone en su dictamen del 22 de agosto de 2022.- III) La Encargada de División Legal, en informe del 08 de setiembre de 2022, comparte lo dictaminado por su Asesor actuante.-</p> <p>CONSIDERANDO: que esta Dirección, de conformidad con lo dictaminado por su División Legal, resolverá en consecuencia.</p> <p>ATENTO: a lo expuesto, a lo que establecen la Ley de Marcas No. 17.011 de 25 de setiembre de 1998, su Decreto Reglamentario No. 34/999 de 3 de febrero de 1999 y disposiciones modificativas.-</p> <p style="text-align: center;">LA DIRECCION NACIONAL DE LA PROPIEDAD INDUSTRIAL</p> <p style="text-align: center;">R E S U E L V E</p> <p>1°.- CONCÉDESE el Registro de la Marca “VIEJO URBAN” (mixta), Acta N° 484.168, solicitada a favor de “ÁLVARO ZALCMAN” de URUGUAY, para proteger los productos y los servicios de las clases internacionales 25 y 35; por el conjunto, sin derechos privativos sobre el término “URBAN” (artículo 7 de la Ley N° 17.011).- 2°.- NOTIFÍQUESE, publíquese, efectúense las anotaciones de estilo y oportunamente archívese.--</p>

MARCA	MINICHIVA
ACTA	489.849
NOMBRE	MAXIMILIANO MOSCARDI RODRIGUEZ Y OTROS
NOTIFICACION	<p>VISTO: La solicitud de Registro de la Marca “MINICHIVA” (mixta), Acta N° 489.849, a favor de “MATHIAS MAXIMILIANO MOSCARDI RODRIGUEZ” de URUGUAY, “MAURICIO CASTELLO” de URUGUAY y “JORGE ANDRES FERNANDEZ CENCIO” de URUGUAY, para cubrir los productos comprendidos en la clase internacional 28.- RESULTANDO: I) Se deduce una oposición de tercero, por parte de “BACONAL S.A.” de URUGUAY, en base al registro de la marca “CHIVITA GOOD BIKE” (mixta) Acta N° 450.915, para la clase internacional 28.-</p> <p>II) División Legal dictamina que correspondería DESESTIMAR la presente solicitud de registro, por los argumentos que expone en su dictamen del 13 de setiembre de 2022.-</p> <p>III) La Encargada de División Legal, en informe de la misma fecha, comparte lo dictaminado por su Asesor actuante.- CONSIDERANDO: que esta Dirección, de conformidad con lo dictaminado por su División Legal, resolverá en consecuencia. ATENTO: a lo expuesto, a lo que establecen la Ley de Marcas No. 17.011 de 25 de setiembre de 1998, su Decreto Reglamentario No. 34/999 de 3 de febrero de 1999 y disposiciones modificativas.-</p> <p style="text-align: center;">LA DIRECCION NACIONAL DE LA PROPIEDAD INDUSTRIAL</p> <p style="text-align: center;">R E S U E L V E</p> <p>1°.- DESESTÍMASE la solicitud de Registro de la Marca “MINICHIVA” (mixta), Acta N° 489.849, a favor de “MATHIAS MAXIMILIANO MOSCARDI RODRIGUEZ” de URUGUAY, “MAURICIO CASTELLO” de URUGUAY y “JORGE ANDRES FERNANDEZ CENCIO” de URUGUAY, para cubrir los productos comprendidos en la clase internacional 28.-</p> <p>2°.- NOTIFÍQUESE, publíquese, efectúense las anotaciones de estilo y oportunamente archívese.---</p>

MARCA	CIELO
ACTA	496.064
NOMBRE	ETOILE SRL
NOTIFICACION	<p>VISTO: La solicitud de Registro de la marca “CIELO” (mixta) Acta N° 496.064, a favor de “ETOILE SRL” de URUGUAY, para cubrir los productos comprendidos en la clase internacional 25.-</p> <p>RESULTANDO: I) Se deducen dos oposiciones: 1- de tercero, por parte de “CELIO FRANCE” de FRANCIA, en base a los registros de las marcas “CELIO” (mixta) Acta N° 443.100, para la clase internacional 25 y “CELIO*” (mixta) Acta N° 386.894 (renovada bajo Acta N° 513.027), para la clase internacional 25 s/d; y 2- de oficio, por parte de la División Examen de Signos Distintivos, en base al registro de la marca “CIELO</p>

	<p>BY PETER PAN” (denominativa) Acta N° 398.615, para la clase internacional 25, a favor de “IVORY INDUSTRIAL HOLDINGS S.A.” de PANAMA.-</p> <p>II) División Legal dictamina que correspondería CONCEDER el presente registro, por los argumentos que expone en su dictamen del 30 de agosto de 2022.-</p> <p>III) La Encargada de División Legal, en informe del 16 de setiembre de 2022, comparte lo dictaminado por su Asesor actuante.-</p> <p>CONSIDERANDO: que esta Dirección, de conformidad con lo dictaminado por su División Legal, resolverá en consecuencia.</p> <p>ATENCIÓN: a lo expuesto, a lo que establecen la Ley de Marcas No. 17.011 de 25 de setiembre de 1998, su Decreto Reglamentario No. 34/999 de 3 de febrero de 1999 y disposiciones modificativas.-</p> <p style="text-align: center;">LA DIRECCION NACIONAL DE LA PROPIEDAD INDUSTRIAL</p> <p style="text-align: center;">R E S U E L V E</p> <p>1°.- CONCÉDESE el Registro de la marca “CIELO” (mixta) Acta N° 496.064, a favor de “ETOILE SRL” de URUGUAY, para cubrir los productos comprendidos en la clase internacional 25.- 2°.- NOTIFÍQUESE, publíquese, efectúense las anotaciones de estilo y oportunamente archívese.--</p>
--	--

MARCA	Q. B. CONTADORES ASOCIADOS
ACTA	494052
NOMBRE	ALEJANDRO DANIEL CHIRICO BERNECHE
NOTIFICACION	<p>Documento: Nro.</p> <p>Expediente: Marca Nro. 494052</p> <p>Signo: Q. B. CONTADORES ASOCIADOS (mixta)</p> <p>Titular: ALEJANDRO DANIEL CHIRICO BERNECHE</p> <p>Clase(s): 35</p> <p>Ponemos de su conocimiento que, del estudio formal del documento de referencia, surgen las siguientes observaciones: Confíerele vista de lo actuado a las partes interesadas por el término de 10 días hábiles.</p>

MARCA	ORGANIZACIÓN NACIONAL DE FUTBOL INFANTIL
ACTA	489686
NOMBRE	ONFI ORGANIZACIÓN NACIONAL DE FUTBOL INFANTIL
NOTIFICACION	VISTO: La solicitud de Registro de la Marca ORGANIZACIÓN NACIONAL DE FUTBOL INFANTIL, mixta, presentada bajo expediente No. 489686 a favor de ONFI ORGANIZACIÓN NACIONAL DE FUTBOL INFANTIL de URUGUAY, para distinguir los servicios comprendidos en las Clases internacionales 35 y 41.

<p>RESULTANDO: I) Se dedujo oposición por la UNION DES ASSOCIATIONS EUROPEENNES DE FOOTBALL (UEFA), representada por la Sra. Agente Nora Morgade, fundada en la confundibilidad con sus registros marcarios “UEFA CHAMPIONS LEAGUE” Actas N° 393.199 y N° 442.491.</p> <p>II) División Legal en su dictamen del 5 de octubre de 2022 informa que entre los signos en pugna se cumplen las claras diferencias requeridas legalmente, por lo cual podrán coexistir pacíficamente, y en su mérito aconseja desestimar la oposición deducida y CONCEDER el presente registro, por el conjunto y sin derechos privativos sobre los términos “ORGANIZACIÓN”, “NACIONAL”, “FUTBOL” e “INFANTIL”, de acuerdo al artículo 7 de la Ley No. 17011 de 25/9/998. III) La Encargada de Área Asuntos Jurídicos, en informe del 6 de octubre de 2022, comparte lo dictaminado por su Asesor actuante.-</p> <p>CONSIDERANDO: que esta Dirección, de conformidad con los dictámenes precedentes, resolverá en consecuencia.</p> <p>ATENTO: a lo expuesto, a lo que establecen la Ley de Marcas No. 17.011 de 25 de septiembre de 1998, su Decreto Reglamentario No. 34/999 de 3 de febrero de 1999 y disposiciones modificativas.-</p> <p style="text-align: center;">LA DIRECCION NACIONAL DE LA PROPIEDAD INDUSTRIAL RESUELVE</p> <p>1°.- CONCÉDESE el Registro de la Marca ORGANIZACIÓN NACIONAL DE FUTBOL INFANTIL, mixta, presentada bajo expediente No. 489686 a favor de ONFI ORGANIZACIÓN NACIONAL DE FUTBOL INFANTIL de URUGUAY, para distinguir los servicios comprendidos en las Clases internacionales 35 y 41, por el conjunto y sin derechos privativos sobre los términos “ORGANIZACIÓN”, “NACIONAL”, “FUTBOL” e “INFANTIL”, de acuerdo al artículo 7 de la Ley No. 17011 de 25/9/998.</p> <p>2°.- NOTIFÍQUESE, publíquese, efectúense las anotaciones de estilo, entréguese el título bajo recibo y oportunamente. archívese</p>

NOTIFICACIONES DE RECURSOS

De conformidad con lo establecido por el numeral 4° del artículo 80 de la Ley 17.011 del 25 de setiembre de 1998 y artículo 87 del decreto N° 34/999 del 3 de febrero de 1999, se notifica a quien se cita a continuación, por razones de su interés, debe presentarse en sección Recursos de la Dirección Nacional de Propiedad Industrial, sita en la calle Rincón 723, 03er. Piso.

MARCA	COMPRALO YA
ACTA	489072
NOMBRE	EDALSIR SOCIEDAD ANONIMA
NOTIFICACION	<p>Documento: Recurso Nro. MA/ 2022/ 028389 Expediente: Marca Nro. 489072 Signo: COMPRALO YA Titular: EDALSIR SOCIEDAD ANONIMA Clase(s): 35 y 38</p> <p style="text-align: right;">Montevideo, 4 de octubre de 2022</p> <p>Del recurso interpuesto confiérese traslado por el término de 10 días hábiles.</p>

MARCA	CIELO
ACTA	496064
NOMBRE	ETOILE SRL
NOTIFICACION	<p>Documento: Recurso Nro. MA/ 2022/ 029778 Expediente: Marca Nro. 496064 Signo: CIELO (mixta) Titular: ETOILE SRL Clase(s): 25</p> <p style="text-align: right;">Montevideo, 5 de octubre de 2022</p> <p>Del recurso interpuesto confiérese traslado por el término de 10 días hábiles.</p>

NOTIFICACIONES DE PATENTES

Por éste medio se cita a quienes figuran a continuación a fin de notificarse de las actuaciones que se indican. Los mismos deberán comunicarse con la mesa de entrada virtual de la Dirección Nacional de la Propiedad Industrial, dentro del plazo de 3 días hábiles siguientes a la fecha de publicación del presente Boletín de la Propiedad Industrial.

E-mail de consultas: marcasypatentes@miem.gub.uy

Si el interesado no se comunica, vencido dicho plazo, se lo considerará notificado y se procederá según lo establecido en el Artículo 39 del Decreto Reglamentario N° 11/000 de 13 de enero de 2000, y Art. 118 de la ley 17.164 de 02 de setiembre de 1999).

<p>a/35830 SENSIBILIDAD ARTIFICIAL Propietario(s): RICHARD EDUARDO MILA MURILLO Vista Examen de Fondo: (45 días)</p>

SOLICITUDES DE PATENTES DE INVENCION**(19) Dirección Nacional de la Propiedad Industrial – URUGUAY****(12) Invención****(11) UY a/038945**

- (51) **Clasificación Internacional:** C 07D 231/56, C 07D 403/14, C 07D 403/12, C 07D 401/14, C 07D 471/04, C 07D 401/12, A 61K 31/4427, A 61K 31/437, A 61K 31/416, A 61P 35/00// A 61P 35/00
- (22) **Fecha de presentación:** 04/11/2020
- (30) **Datos de prioridad:**
- (71) **Solicitante:** ARRAY BIOPHARMA INC. [US]
- (72) **Inventor:** ZHAO, Qian [CN]; BOYS, Mark Laurence [US]; BRADLEY, Michael [US]; DeLISLE, Robert Kirk [US]; HENNINGS, D. David [US]; KENNEDY, April L. [US]; TOPALOV, George T. [BG]; MEDINA, Matthew [US]; MUNSON, Mark C. [US]; RAST, Bryson [US]; RIZZI, James P. [US]; RODRIGUEZ, Martha E. [US]; MARMSÄTER, Fredrik P. [SE]
- (74) **Agente/apoderado:** CARLOS EDUARDO SARLABÓS BUZÓ (189)
- (54) **Título:** COMPUESTOS SUSTITUIDOS DE N-(1H-INDAZOL-4-IL)IMIDAZO[1,2-a]PIRIDIN-3-CARBOXAMIDA COMO INHIBIDORES DE cFMS

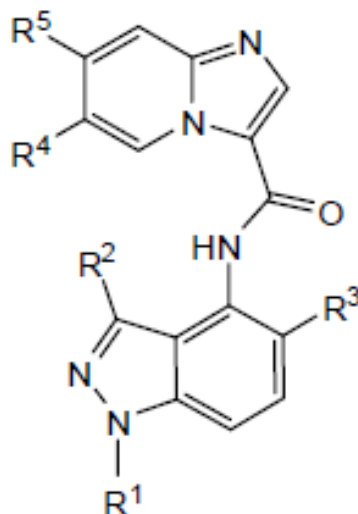

- (57) **Resumen:** Compuestos de la fórmula I y sus sales farmacéuticamente aceptables, en donde R1, R2, R3, R4 y R5 tienen los significados dados en la memoria descriptiva, son inhibidores de cFMS y son de utilidad en el tratamiento de enfermedades relacionadas con los huesos, cáncer, trastornos autoinmunes, enfermedades inflamatorias, enfermedades cardiovasculares y dolor.

(19) Dirección Nacional de la Propiedad Industrial – URUGUAY**(12) Invención****(11) UY a/039121**

- (51) Clasificación Internacional:** A 23L 33/105(2016.01), A 61K 47/34(2017.01), A 61K 9/107(2006.01), A 61K 36/185(2006.01)
- (22) Fecha de presentación:** 09/03/2021
- (30) Datos de prioridad:**
- (71) Solicitante:** Hai Beverages Inc. [CA]
- (72) Inventor:** SAZZAD HOSSAIN [CA]; ROBERT AUGUST [CA]; MICHAEL MCCUNE [CA]
- (74) Agente/apoderado:** Juan Eduardo Vanrell Falcon (144)
- (54) Título:** COMPOSICIÓN DE BEBIDA CANNABINOIDE SOLUBLE EN AGUA

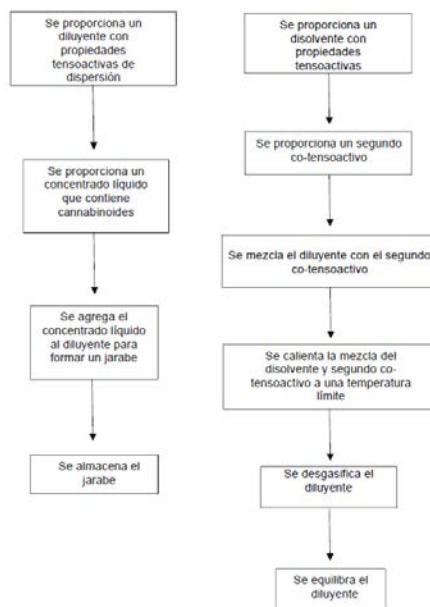

- (57) Resumen:** Se puede preparar un jarabe para bebidas que contenga cannabinoides solubilizando cannabinoides insolubles en un diluyente que tenga propiedades tensoactivas de dispersión. El diluyente puede prepararse mezclando un disolvente con propiedades tensoactivas, como el polisorbato 80, con un co-tensoactivo, como el propilenglicol. Los cannabinoides sólidos pueden solubilizarse calentando el concentrado sólido hasta licuarlo, y añadiendo después el concentrado líquido al diluyente preparado. El jarabe resultante puede almacenarse para su uso en la elaboración de bebidas.

(19) Dirección Nacional de la Propiedad Industrial – URUGUAY**(12) Invención****(11) UY a/039405**

- (51) Clasificación Internacional:** A 61K 33/00(2006.01), A 61K 35/02(2015.01), A 61K 36/736(2006.01), A 61K 36/47(2006.01), A 61K 36/53(2006.01), A 61K 35/28(2015.01)
- (22) Fecha de presentación:** 01/09/2021
- (30) Datos de prioridad:**
- (71) Solicitante:** MARIANELA BENAVIDES [UY]
- (72) Inventor:** MARIANELA BENAVIDES [UY]
- (74) Agente/apoderado:** MARIANELA BENAVIDES ()
- (54) Título:** FORMULACIÓN PREPARADA PARA LA CALVICIE A BASE DE HIERBAS, ACEITES Y MINERALES
- (57) Resumen:** "Formulación de un compuesto capilar preparado a base de hierbas aceites y minerales" se refiere a una formulación de un compuesto natural envasado por separado en un kit elaborado con la mezcla de aceites, extractos y arcillas verde y blanca, caracterizado en forma de la composición envasados (500 g) máscara de arcilla blanca y (500gr) Arcilla verde; (120ml) tónico capilar de Romero y (200ml) del mix de aceites, proporcionando así un resultado muy eficaz en el tratamiento de pérdida de cabello.

(19) Dirección Nacional de la Propiedad Industrial – URUGUAY**(12) Invención****(11) UY a/039606**

- (51) **Clasificación Internacional:** G 06T 7/00(2017.01), G 06T 7/11(2017.01), F 27B 1/28(2006.01)
- (22) **Fecha de presentación:** 10/01/2022
- (30) **Datos de prioridad:** 20215014 08/01/2021 FI
- (71) **Solicitante:** ANDRITZ OY [FI]
- (72) **Inventor:** TASKINEN Antti [FI]; TORMIKOSKI Pekka [FI]; AALTONEN Ossi [FI]; LAPPI Heikki [FI]; VIITANEN Timo [FI]
- (74) **Agente/apoderado:** FABIANA PENADES (216)
- (54) **Título:** MÉTODO Y SISTEMA PARA EL MONITOREO Y CONTROL DE LLAMA

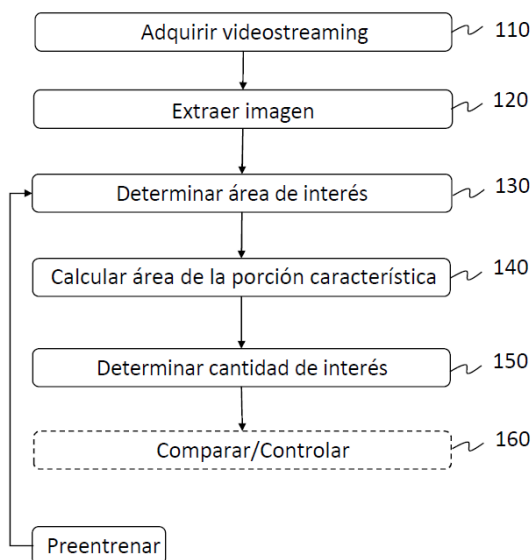

- (57) **Resumen:** Un método para monitorear una llama de un quemador de un horno de cal, siendo que el mismo comprende adquirir imágenes de videostreaming que muestran el extremo del quemador del horno de cal; extraer al menos una imagen a partir del videostreaming adquirido; determinar a partir de la al menos una imagen, utilizando un algoritmo preentrenado, al menos un área de interés, siendo que el al menos un área de interés comprende una parte de la al menos una imagen que muestra un área que comprende al menos una porción característica de la llama y/o [del] extremo del quemador.

(19) Dirección Nacional de la Propiedad Industrial – URUGUAY**(12) Invención****(11) UY a/039660**

- (51) **Clasificación Internacional:** H 01B 11/22(2006.01), H 02G 7/00(2006.01)
(22) **Fecha de presentación:** 07/03/2022
(30) **Datos de prioridad:** 63/157,603 05/03/2021 US
(71) **Solicitante:** CTC Global Corporation [US]
(72) **Inventor:** William WEBB [US]; Douglas A. PILLING [US]; Christopher WONG [US]; Ian M. PILLING [US]
(74) **Agente/apoderado:** ALEJANDRO ALTERWAIN BRUK (221)
(54) **Título:** EQUIPOS QUE PERMITEN LA INTERFAZ CON FIBRAS ÓPTICAS EN UN CABLE ELÉCTRICO AÉREO

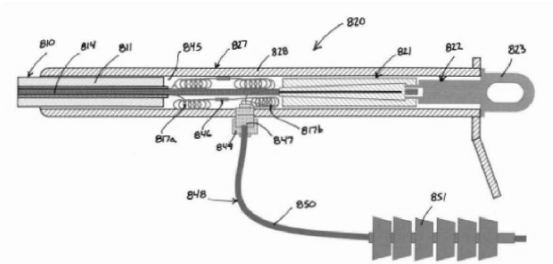

- (57) **Resumen:** Componentes para terminar y/o empalmar cables eléctricos aéreos que tienen fibras ópticas asociadas con los cables. Los componentes permiten el acceso a las fibras ópticas para conectarlas con dispositivos de interrogación o para conectarlas con equipos de telecomunicaciones. Los componentes también permiten que las fibras ópticas pasen a través de terminaciones y empalmes sin dañar las fibras ópticas.

(19) Dirección Nacional de la Propiedad Industrial – URUGUAY

(12) Invención

(11) UY a/039661

- (51) **Clasificación Internacional:** A 01N 43/08(2006.01), A 01N 43/40(2006.01), A 01N 43/56(2006.01), A 01P 7/04(2006.01), C 07D 307/93(2006.01), C 07D 405/12(2006.01)// A 01P 7/04
- (22) **Fecha de presentación:** 08/03/2022
- (30) **Datos de prioridad:** 63/158,513 09/03/2021 US
- (71) **Solicitante:** FMC CORPORATION [US]
- (72) **Inventor:** Zhengao FENG [CN]; Andrew Jon DEANGELIS [US]
- (74) **Agente/apoderado:** STELLA MARINA WENG POLICICCHIO (218)
- (54) **Título:** AMIDAS BICÍCLICAS PARA CONTROLAR PLAGAS DE INVERTEBRADOS

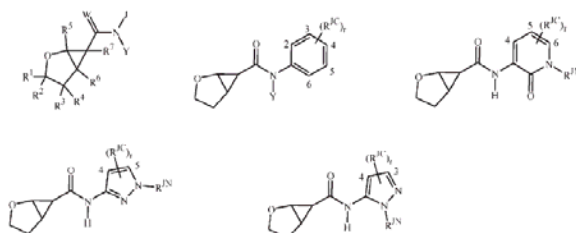

- (57) **Resumen:** Se divulgan compuestos de Fórmula 1, incluyendo todos los isómeros geométricos y estereoisómeros, N-óxidos y sales de los mismos, en donde R1, R2, R3, R4, R5, R6, R7, W, J e Y son como se definen en la divulgación. También se divulgan composiciones que contienen los compuestos de Fórmula 1 y métodos para controlar una plaga de invertebrados que comprenden poner en contacto la plaga de invertebrados o su entorno con una cantidad biológicamente eficaz de un compuesto o una composición de la divulgación.

(19) Dirección Nacional de la Propiedad Industrial – URUGUAY**(12) Invención****(11) UY a/039667**

- (51) **Clasificación Internacional:** C 07D 207/46(2006.01), C 07D 403/12(2006.01), C 07D 401/14(2006.01), C 07D 401/12(2006.01), C 07D 211/56(2006.01), C 07D 207/08(2006.01), C 07D 405/12(2006.01), C 07D 211/06(2006.01), A 61K 31/55(2006.01), A 61K 31/4427(2006.01), A 61K 31/4025(2006.01), A 61P 13/12(2006.01), A 61P 1/16(2006.01)// A 61P 1/16, 13/12
- (22) **Fecha de presentación:** 10/03/2022
- (30) **Datos de prioridad:** 63/159,271 10/03/2021 US; 63/226,551 28/07/2021 US; 63/234,487 18/08/2021 US; 63/292,815 22/12/2021 US y 63/308,790 10/02/2022 US
- (71) **Solicitante:** Jnana Therapeutics Inc. [US]
- (72) **Inventor:** BROWN, Dean G. [US]; HENDERSON, Jaclyn L. [GB]; MUNCIPINTO, Giovanni [US]; HOLLIBAUGH, Ryan A. [US]; NGUYEN, Long V [US]; PULLEN, Nicholas [US]; ANTALEK, Mitchell T. [US]; ZWEIG, Joshua E. [US]
- (74) **Agente/apoderado:** STELLA MARINA WENG POLICICCHIO (218)
- (54) **Título:** INHIBIDORES DE MOLÉCULA PEQUEÑA DE LA FUNCIÓN DE SLC6A19 DE MAMÍFERO

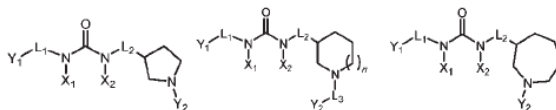
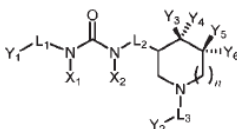

- (57) **Resumen:** Compuestos, composiciones y métodos que son de utilidad para tratar o prevenir una enfermedad o trastorno asociado con niveles de aminoácidos anormales mediante la modulación del transporte de SLC6A19.

(19) Dirección Nacional de la Propiedad Industrial – URUGUAY**(12) Invención****(11) UY a/039668**

- (51) Clasificación Internacional:** C 11D 1/86(2006.01), C 11D 3/386(2006.01), C 11D 3/382(2006.01), C 11D 3/22(2006.01)
- (22) Fecha de presentación:** 10/03/2022
- (30) Datos de prioridad:** 63/159,860 11/03/2021 US
- (71) Solicitante:** Suzano S.A. [BR]
- (72) Inventor:** RICHIELI TELES VIEIRA [BR]; Bruna Papa Spadafora [BR]; Matheus Antunes Guimarães [BR]
- (74) Agente/apoderado:** VIRGINIA CERVIERI GHIOLDI (212)
- (54) Título:** ESTRUCTURA DE MATRIZ PARA UNA COMPOSICIÓN DE DETERGENTE PARA ROPA, COMPOSICIÓN SÓLIDA DE DETERGENTE PARA ROPA, PROCESO PARA PRODUCIR UNA COMPOSICIÓN SÓLIDA DE DETERGENTE PARA ROPA, FORMA DE DETERGENTE DE DOSIFICACIÓN UNITARIA, USO DE CELULOSA MICROFIBRILADA
- (57) Resumen:** La invención se refiere a una estructura de matriz para una composición en forma sólida de detergente para ropa que tiene al menos 15% de celulosa microfibrilada (MFC). La inclusión de un tensioactivo en la estructura de matriz de MFC proporciona una composición sólida de detergente para ropa que tiene de 5% a 20% de celulosa microfibrilada. Además, se proporciona un proceso para producir una composición de detergente sólido para ropa que tiene las etapas de mezclar celulosa microfibrilada con al menos un tensioactivo, un agente potenciador de compresión y compactar la mezcla resultante para obtener detergente sólido para ropa.

(19) Dirección Nacional de la Propiedad Industrial – URUGUAY**(12) Invención****(11) UY a/039671**

- (51) **Clasificación Internacional:** C 07D 471/04(2006.01), C 07D 487/04(2006.01), A 61K 31/437(2006.01), A 61K 31/4353(2006.01), A 61K 31/4985(2006.01), A 61P 7/00(2006.01)
// A 61P 7/00
- (22) **Fecha de presentación:** 11/03/2022
- (30) **Datos de prioridad:** 63/161139 15/03/2021 US y 63/164130 22/03/2021 US
- (71) **Solicitante:** NOVARTIS AG [CH]
- (72) **Inventor:** MANNING, James R. [US]; BONAZZI, Simone [CH]; CERNIJENKO, Artiom [LT]; MALIK, Hasnain Ahmed [GB]; THOMSEN, Noel Marie-France [US]; COBB, Jennifer Stroka [US]; YF TING, Pamela [US]; DEWHURST, Janetta [US]; HESSE, Matthew James [GB]; JAIN, Rama [US]; KERRIGAN, John Ryan [US]; O'BRIEN, Gary [CA]; PATTERSON, Andrew W. [US]; DALES, Natalie Alysia [US]
- (74) **Agente/apoderado:** JUAN LAPENNE DE SALTERAIN (211)
- (54) **Título:** Derivados de pirazolopiridina y sus usos.

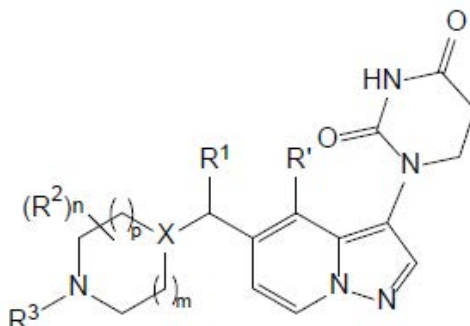

- (57) **Resumen:** La presente divulgación se refiere a compuestos de Fórmula (I) y composiciones farmacéuticas y su uso en la reducción de los niveles de expresión de los Motivos de Dedos de Zinc Ampliamente Interespaciados (WIZ), o en la inducción de la expresión de la hemoglobina fetal (HbF), y en el tratamiento de trastornos de la sangre hereditarios (por ejemplo, hemoglobinopatías, por ejemplo, beta-hemoglobinopatías), tales como enfermedad de células falciformes y beta-talasemia.

(19) Dirección Nacional de la Propiedad Industrial – URUGUAY**(12) Invención****(11) UY a/039672**

- (51) **Clasificación Internacional:** C 07C 67/02(2006.01), C 08B 3/10(2006.01), C 08B 15/00(2006.01), C 08H 8/00(2010.01), C 12N 11/14(2006.01), C 12N 9/20(2006.01), C 12P 7/62(2006.01), D 21C 3/20(2006.01), A 61K 8/66(2006.01), B 82Y 40/00(2011.01)
- (22) **Fecha de presentación:** 14/03/2022
- (30) **Datos de prioridad:** BR 10 2021 005126 4 18/03/2021 BR
- (71) **Solicitante:** Suzano S.A. [BR] y UNIVERSIDADE DE SÃO PAULO - USP [BR]
- (72) **Inventor:** GERMANO SIQUEIRA [BR]; BRAZ DE SOUZA MAROTTI [BR]; VALDEIR ARANTES [BR]
- (74) **Agente/apoderado:** VIRGINIA CERVIERI GHIOLDI (212)
- (54) **Título:** CELULOSA FUNCIONALIZADA, MÉTODO DE FUNCIONALIZACIÓN ENZIMÁTICA DE CELULOSA, PROCESO DE FUNCIONALIZACIÓN ENZIMÁTICA DE CELULOSA A PARTIR DE UN ÁCIDO ORGÁNICO Y PROCESO PARA LA PRODUCCIÓN DE UNA CELULOSA CON HIDROFOBICIDAD AUMENTADA Y ARTÍCULO

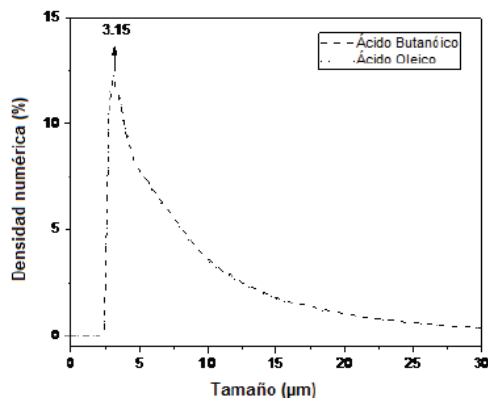

- (57) **Resumen:** La presente invención se refiere a una celulosa funcionalizada, en donde la celulosa comprende grupos ésteres hidrofóbicos provenientes de ácidos grasos, así como a sus procesos y métodos de funcionalización de la celulosa de manera de conferirle una característica hidrofóbica aumentada.

(19) Dirección Nacional de la Propiedad Industrial – URUGUAY**(12) Invención****(11) UY a/039673**

- (51) Clasificación Internacional:** C 07D 471/04, A 61K 31/519, A 61P 35/00// A 61P 35/00
- (22) Fecha de presentación:** 16/03/2022
- (30) Datos de prioridad:** 63/162,273 17/03/2021 US; 63/185,054 06/05/2021 US y 63/190,096 18/05/2021 US
- (71) Solicitante:** AMGEN INC. [US]
- (72) Inventor:** Gataree NGARMCHAMNANRITH [US]; Gregory FRIBERG [US]; Sandeep DUTTA [US]; Brett E. HOUK [US]; Omar MATHER [US]; Haby HENARY [US]
- (74) Agente/apoderado:** FABIANA PENADES (216)
- (54) Título:** PAUTA POSOLÓGICA DE SOTORASIB
- (57) Resumen:** En el presente documento se proporcionan métodos de administración de una dosis diaria total de 240 mg de sotorasib a un paciente que padece un cáncer que tiene una mutación KRAS G12C. En el presente documento también se proporcionan métodos para tratar un cáncer con mutación KRAS G12C en un paciente, que comprenden la administración de una dosis diaria total de 960 mg de sotorasib al paciente, y la reducción de la dosis diaria total de sotorasib a 480 mg en un paciente que experimenta un acontecimiento adverso a la dosis de 960 mg de sotorasib.

(19) Dirección Nacional de la Propiedad Industrial – URUGUAY**(12) Invención****(11) UY a/039674**

- (51) Clasificación Internacional:** A 01N 25/02, A 01N 25/04, A 01N 25/30, A 01N 43/40, A 01P 3/00, A 01P 5/00, C 07D 213/81, C 07D 213/82// C 07D 213/81, 213/82
- (22) Fecha de presentación:** 17/03/2022
- (30) Datos de prioridad:** 21163830.9 19/03/2021 EP; 21163833.3 19/03/2021 EP y 21163835.8 19/03/2021 EP
- (71) Solicitante:** SYNGENTA CROP PROTECTION AG [CH]
- (72) Inventor:** MEUNIER, Celine [FR]; JANKER, Marion [DE]; GARO, Kerstin [DE]; BIRCHER, Rene Rolf [CH]; SCHNEIDER, Sandra [CH]; KIENTZ, Heloise [CH]; BREMONT, Anne-Laure [FR]; SIEBOLD, Claudia [DE]
- (74) Agente/apoderado:** JUAN LAPENNE DE SALTERAIN (211)
- (54) Título:** Nueva composición de concentrado en suspensión de ciclobutrifluram acuosa.
- (57) Resumen:** La presente invención se refiere a una composición de concentrado en suspensión acuosa útil en agricultura para controlar plagas dañinas para cultivos comerciales, que comprende (i) ciclobutrifluram como principio activo; (ii) de 1 a 30 gramos / litro de un agente humectante de sulfosuccinato; (iii) de 5 a 50 gramos / litro de un copolímero de bloque de butilo-poli(óxido de alquileo); y (iv) de 2.5 a 35 gramos / litro de un lignosulfonato de sodio.

(19) Dirección Nacional de la Propiedad Industrial – URUGUAY**(12) Invención****(11) UY a/039675**

- (51) **Clasificación Internacional:** A 01N 25/02, A 01N 25/04, A 01N 25/30, A 01N 43/90, A 01P 7/02, A 01P 7/04, C 07D 471/10// C 07D 471/10
- (22) **Fecha de presentación:** 17/03/2022
- (30) **Datos de prioridad:** 21163726.9 19/03/2021 EP
- (71) **Solicitante:** SYNGENTA CROP PROTECTION AG [CH]
- (72) **Inventor:** POPP, Christian [DE]; SCHNEIDER, Daniel [CH]
- (74) **Agente/apoderado:** JUAN LAPENNE DE SALTERAIN (211)
- (54) **Título:** Composiciones de concentrado en suspensión plaguicidas que comprenden principio activo de espiropidión y combinación de agente dispersante binario

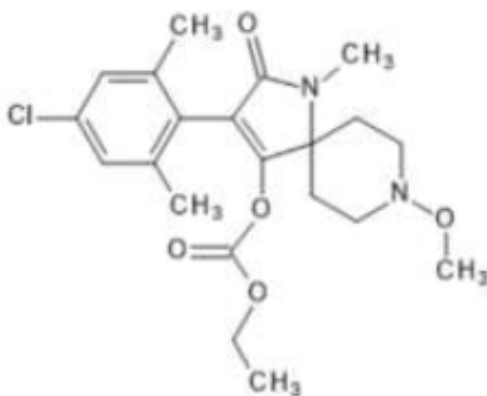

- (57) **Resumen:** Una composición plaguicida que comprende: (a) del 20 al 35% en peso de espiropidión como principio activo, y (b) del 5.5 al 15% en peso de una combinación de agente de dispersión, que comprende: (i) del 5 al 10% en peso de la composición total de una disolución de copolímero de injerto acrílico en agua y propilenglicol; y (ii) del 0.5 al 5% en peso de la composición total de un condensado de alquilnaftalenosulfonato de sodio-formaldehído.

(19) Dirección Nacional de la Propiedad Industrial – URUGUAY**(12) Invención****(11) UY a/039676**

- (51) **Clasificación Internacional:** C 07D 487/04(2006.01), C 07D 471/04(2006.01), A 61K 31/437(2006.01), A 61K 31/519(2006.01), A 61P 35/00(2006.01)// A 61P 35/00
- (22) **Fecha de presentación:** 17/03/2022
- (30) **Datos de prioridad:** 63/162,640 18/03/2021 US y 63/165,459 24/03/2021 US
- (71) **Solicitante:** PFIZER INC. [US]
- (72) **Inventor:** JALAIIE, Mehran [US]; WYTHES, Martin James [GB]; GAJIWALA, Ketan Satish [US]; RUI, Eugene Yuanjin [US]; PATMAN, Ryan Lloyd [US]; SUN, Jianmin [US]; HUH, Chan Woo [KR]
- (74) **Agente/apoderado:** JUAN LAPENNE DE SALTERAIN (211)
- (54) **Título:** MODULADORES DE STING (ESTIMULADOR DE GENES DE INTERFERÓN)

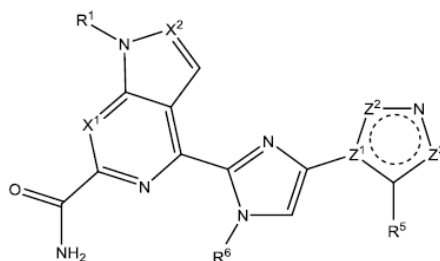

- (57) **Resumen:** En la presente se proporcionan compuestos de la Fórmula general (I) , y sales aceptables desde el punto de vista farmacéutico de estos, procesos para la preparación de estos compuestos, composiciones que contienen estos compuestos y los usos de estos compuestos.

(19) Dirección Nacional de la Propiedad Industrial – URUGUAY

(12) Invención

(11) UY a/039680

- (51) **Clasificación Internacional:** C 07D 231/56(2006.01), C 07D 498/22(2006.01), C 07D 498/18(2006.01), C 07D 498/08(2006.01), C 07D 491/18(2006.01), C 07D 513/18(2006.01), C 07D 491/08(2006.01), A 61K 31/439(2006.01), A 61K 31/4192(2006.01), A 61K 31/4162(2006.01), A 61P 9/00(2006.01), A 61P 25/00(2006.01)// A 61P 25/00, 9/00
- (22) **Fecha de presentación:** 18/03/2022
- (30) **Datos de prioridad:** 21305334.1 18/03/2021 EP y 21306329.0 24/09/2021 EP
- (71) **Solicitante:** LES LABORATOIRES SERVIER [FR] y ONCODESIGN SA [FR]
- (72) **Inventor:** DUMOULIN, Audrey [FR]; BLOM, Petra Marcella [BE]; DAUGAN, Alain [FR]; LAUGEOIS, Maxime [FR]; CHRISTENSEN, Kenneth [DK]; DENIS, Alexis [FR]; LAMOTTE, Yann [FR]; LE TIRAN, Arnaud [FR]; HOUSSEMAN, Christopher Gaétan [FR]
- (74) **Agente/apoderado:** Juana Bacot (245)
- (54) **Título:** NUEVOS INHIBIDORES MACROCÍCLICOS DE LA QUINASA DE LRRK2

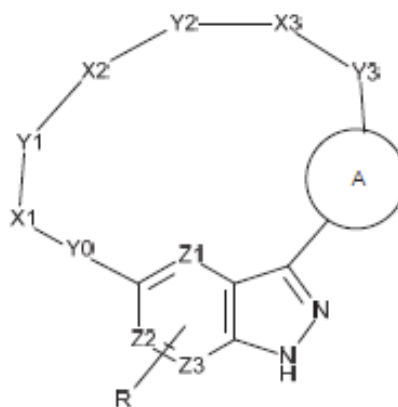

- (57) **Resumen:** NUEVOS INHIBIDORES MACROCÍCLICOS DE LA QUINASA DE LRRK2 Compuestos de fórmula (I): en donde R, Z1, Z2, Z3, Y0, X1, Y1, X2, Y2, X3, Y3 y A son como se han definido en la descripción. Medicamentos

(19) Dirección Nacional de la Propiedad Industrial – URUGUAY**(12) Invención****(11) UY a/039681**

- (51) Clasificación Internacional:** C 07D 217/02(2006.01), C 07D 405/12(2006.01), C 07D 401/12(2006.01), C 07D 239/74(2006.01), C 07D 417/12(2006.01), A 61K 31/517(2006.01), A 61K 31/4725(2006.01), A 61K 31/472(2006.01), A 61P 27/02(2006.01)// A 61P 27/02
- (22) Fecha de presentación:** 22/03/2022
- (30) Datos de prioridad:** 63/166289 26/03/2021 US
- (71) Solicitante:** Novartis AG [CH]
- (72) Inventor:** LIU, Donglei [US]; Peukert, Stefan [DE]; Papillon, Julien [US]; POWERS, James J. [US]
- (74) Agente/apoderado:** JUAN LAPENNE DE SALTERAIN (211)
- (54) Título:** Derivados de ciclobutilo 1,3-sustituídos y sus usos

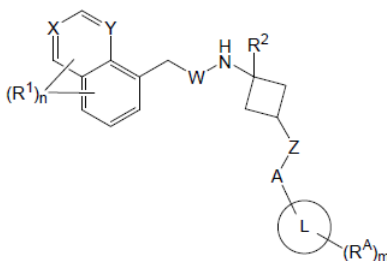

- (57) Resumen:** En el presente documento se proporcionan compuestos y composiciones farmacéuticas útiles para el tratamiento de enfermedades o trastornos mediados por el receptor TRPV1. La presente invención además proporciona métodos para el tratamiento de enfermedades o trastornos oculares mediante la administración, a un sujeto que lo necesita, de una cantidad terapéuticamente eficaz de un compuesto de Fórmula (I) o una composición farmacéutica descritos en el presente documento.

(19) Dirección Nacional de la Propiedad Industrial – URUGUAY**(12) Invención****(11) UY a/039684**

- (51) **Clasificación Internacional:** A 01D 45/22(2006.01), A 01D 41/14(2006.01)
(22) **Fecha de presentación:** 23/03/2022
(30) **Datos de prioridad:** 20210100777 29/03/2021 AR
(71) **Solicitante:** GentleFarming Sàrl [LU] y G FAS SAS [AR]
(72) **Inventor:** Ana Fernández Mouján [AR]
(74) **Agente/apoderado:** JUAN LAPENNE DE SALTERAIN (211)
(54) **Título:** CABEZAL COSECHADOR PARA MULTICULTIVOS

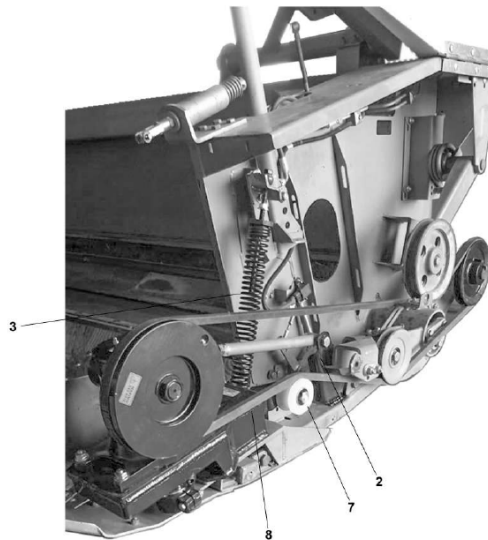

- (57) **Resumen:** En cada extremo del chasis hay una cadena cinemática vinculada a un módulo barra de corte provisto de un rotor y un molinete o un módulo stripper con llanta de mando. Los módulos están fijados a los laterales del chasis mediante bulones ubicados en orificios comunes a ambos. La cadena acciona el rotor o la llanta desde el órgano alimentador. El molinete está colgado de un conjunto de soportes ubicados en la parte superior del chasis, que permiten fijar el deflector del módulo stripper y alimentados con el sistema hidráulico que les permite moverse hacia adelante, atrás, arriba y abajo.

(19) Dirección Nacional de la Propiedad Industrial – URUGUAY**(12) Invención****(11) UY a/039686**

- (51) **Clasificación Internacional:** C 13K 5/00(2006.01), A 23C 9/144(2006.01), A 23C 9/142(2006.01), A 23C 9/146(2006.01), A 23J 3/08(2006.01)
- (22) **Fecha de presentación:** 24/03/2022
- (30) **Datos de prioridad:** 2103028 25/03/2021 FR
- (71) **Solicitante:** EURODIA INDUSTRIE [FR]
- (72) **Inventor:** Florence LUTIN [FR]; Denis LARGETEAU [FR]; Anne GONIN [FR]
- (74) **Agente/apoderado:** JUAN LAPENNE DE SALTERAIN (211)
- (54) **Título:** Proceso para procesar una composición de proteína láctea para la fabricación de una composición líquida

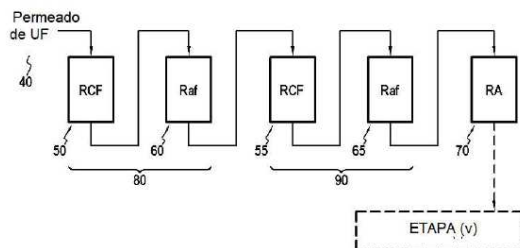

- (57) **Resumen:** La presente invención se refiere a un procedimiento de tratamiento de una composición proteica láctea para la obtención de una composición líquida rica en lactosa que comprende una etapa (ii) de ultrafiltración para la obtención de un permeado de ultrafiltración y de un retentado de ultrafiltración; seguido de una etapa de tratamiento sobre resinas intercambiadoras de iones (iv) que comprende al menos un paso que comprende la percolación sobre una resina catiónica seguida de una percolación sobre una resina aniónica.

(19) Dirección Nacional de la Propiedad Industrial – URUGUAY**(12) Invención****(11) UY a/039688**

- (51) **Clasificación Internacional:** C 07D 209/44(2006.01), C 07D 401/06(2006.01), C 07D 471/04(2006.01), A 61K 31/4439(2006.01), A 61K 31/4375(2006.01), A 61K 31/4035(2006.01), A 61K 31/4965(2006.01), A 61P 25/00(2006.01)// A 61P 25/00
- (22) **Fecha de presentación:** 24/03/2022
- (30) **Datos de prioridad:** 63/166,516 26/03/2021 US
- (71) **Solicitante:** NOVARTIS AG [CH] y CADENT THERAPEUTICS, INC. [US]
- (72) **Inventor:** Kevin Matthew GARDINIER [US]; Mark Patrick HEALY [US]; Keith JENDZA [US]; Fan YANG [US]; Yue PAN [CN]; Kate Yaping WANG [US]
- (74) **Agente/apoderado:** VIRGINIA CERVIERI GHIOLDI (212)
- (54) **Título:** Moduladores Alostéricos Negativos Novedosos de Ciclopenta[c]pirrol de NR2B

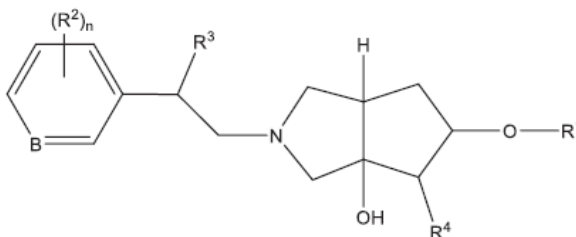

- (57) **Resumen:** La presente divulgación proporciona un compuesto de la fórmula (I), o una sal farmacéuticamente aceptable del mismo; un método para fabricar los compuestos de la divulgación y sus usos terapéuticos. La presente descripción proporciona además una combinación de agentes farmacológicamente activos y una composición farmacéutica.

(19) Dirección Nacional de la Propiedad Industrial – URUGUAY**(12) Invención****(11) UY a/039690**

- (51) Clasificación Internacional:** A 01N 37/22(2006.01), A 01N 37/46(2006.01), A 01N 43/80(2006.01), C 07D 277/20(2006.01)
- (22) Fecha de presentación:** 25/03/2022
- (30) Datos de prioridad:** 21165760.6 30/03/2021 EP
- (71) Solicitante:** SYNGENTA CROP PROTECTION AG [CH]
- (72) Inventor:** TELLIS, Jenny [GB]; BROQUET, Jean-Charles Daniel Nicolas [FR]
- (74) Agente/apoderado:** JUAN LAPENNE DE SALTERAIN (211)
- (54) Título:** COMPOSICIÓN QUE COMPRENDE INGREDIENTES AGROQUÍMICOS Y UN COMPUESTO DE LACTAMIDA

- (57) Resumen:** La presente invención se refiere a una composición que comprende oxatiapiprolina y metalaxil-M. Más particularmente, la presente invención se refiere a formulaciones, tales como concentrados dispersables (CD) o concentrados emulsionables (CE); a diluciones o dispersiones de tales formulaciones, más particularmente en un tanque de pulverización de un agricultor; y al uso de tal composición en agricultura u horticultura para el control o la prevención de la infestación de plantas por microorganismos fitopatógenos, preferentemente hongos.

(19) Dirección Nacional de la Propiedad Industrial – URUGUAY**(12) Invención****(11) UY a/039691**

- (51) **Clasificación Internacional:** E 05B 73/00(2006.01), A 45C 13/18(2006.01)
(22) **Fecha de presentación:** 25/03/2022
(30) **Datos de prioridad:** PCT/CL2021/050021 26/03/2021 CL
(71) **Solicitante:** Emilio Alfonso de la Jara Hartwig [CL]
(72) **Inventor:** ECHEVERRÍA LAVÍN, Rodrigo [CL]; DE LA JARA HARTWIG, Emilio Alfonso [CL]
(74) **Agente/apoderado:** STELLA MARINA WENG POLICICCHIO (218)
(54) **Título:** SISTEMA DE MONTAJE ANTI-VANDALISMO PARA EL MONITOREO DE VARIABLES FÍSICAS DEL AGUA.



- (57) **Resumen:** SISTEMA DE MONTAJE ANTI-VANDALISMO PARA EL MONITOREO DE VARIABLES FÍSICAS DEL AGUA, QUE COMPRENDE: UN PRIMER MIEMBRO; UN SEGUNDO MIEMBRO; UN TERCER MIEMBRO; Y UN CUARTO MIEMBRO; EN DONDE EL PRIMER MIEMBRO COMPRENDE UNA PLURALIDAD DE COMPARTIMIENTOS PARA ALOJAR UNA PLURALIDAD DE DISPOSITIVOS. PROCEDIMIENTO DE ARMADO.

(19) Dirección Nacional de la Propiedad Industrial – URUGUAY**(12) Invención****(11) UY a/039693**

- (51) **Clasificación Internacional:** C 07C 37/14(2006.01), C 07C 37/16(2006.01), C 07C 69/34(2006.01), C 07C 39/17(2006.01), C 07C 67/31(2006.01), C 07C 37/18(2006.01)
- (22) **Fecha de presentación:** 25/03/2022
- (30) **Datos de prioridad:** 2104286.6 26/03/2021 GB
- (71) **Solicitante:** SYNGENTA CROP PROTECTION AG [CH]
- (72) **Inventor:** STAIGER, Roman [DE]; BEAUDEGNIES, Renaud [CH]
- (74) **Agente/apoderado:** JUAN LAPENNE DE SALTERAIN (211)
- (54) **Título:** PROCESO QUÍMICO PARA LA SÍNTESIS DE COMPUESTOS DE METOXIACRILATO SUSTITUIDO

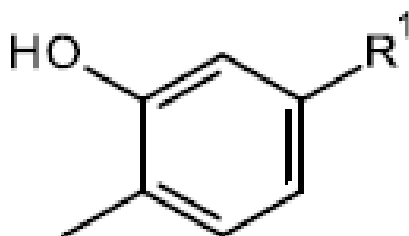

- (57) **Resumen:** La presente invención proporciona, entre otras cosas, un proceso para producir un compuesto de fórmula (I) (I) donde los sustituyentes son tal como se definen en la reivindicación 1. La presente invención proporciona además compuestos intermedios utilizados en dicho proceso y métodos para producir dichos compuestos intermedios.

(19) Dirección Nacional de la Propiedad Industrial – URUGUAY**(12) Invención****(11) UY a/039694**

- (51) **Clasificación Internacional:** C 07D 487/04, C 07D 409/14, C 07D 403/12, C 07D 209/14, C 07D 471/04, A 61K 31/4985, A 61K 31/437, A 61K 31/4035, A 61K 31/382, A 61P 35/00// A 61P 35/00
- (22) **Fecha de presentación:** 25/03/2022
- (30) **Datos de prioridad:** PCT/CN2021/083170 26/03/2021 CN; PCT/CN2021/090933 29/04/2021 CN; PCT/CN2021/111470 09/08/2021 CN; PCT/CN2021/128941 05/11/2021 CN; PCT/CN2021/130098 11/11/2021 CN; PCT/CN2021/138808 16/12/2021 CN; PCT/CN2021/143042 30/12/2021 CN y PCT/CN2022/071547 12/01/2022 CN
- (71) **Solicitante:** Jacobio Pharmaceuticals Co., Ltd. [CN]
- (72) **Inventor:** Wei LONG [CN]; Yanping WANG [CN]; Fashun YAN [CN]; Xiuwei LI [CN]; Guiqun YANG [CN]; Yang YE [CN]
- (74) **Agente/apoderado:** GONZALO FERNÁNDEZ SECCO (34)
- (54) **Título:** NOVEDOSOS COMPUESTOS ÚTILES COMO AGONISTAS DE STING Y SUS USOS

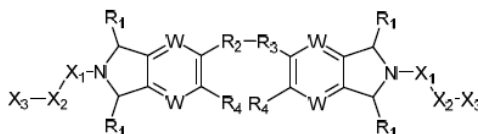

- (57) **Resumen:** Se proporcionan compuestos de la Fórmula general S-1, S-2, S-3 y sus sales farmacéuticamente aceptables, que pueden ser útiles como inductores de la producción de interferón tipo I, específicamente como agentes activos de STING. También se proporcionan síntesis, composiciones y usos de dichos compuestos.

(19) Dirección Nacional de la Propiedad Industrial – URUGUAY**(12) Invención****(11) UY a/039695**

- (51) **Clasificación Internacional:** A 01N 43/40, A 01N 43/653, A 01N 43/80, A 01N 43/832, A 01N 43/836, C 07D 401/12, C 07D 401/14, C 07D 413/14, C 07D 417/14
- (22) **Fecha de presentación:** 28/03/2022
- (30) **Datos de prioridad:** 202111014417 30/03/2021 IN
- (71) **Solicitante:** SYNGENTA CROP PROTECTION AG [CH]
- (72) **Inventor:** SIKERVAR, Vikas [IN]; HUETER, Ottmar Franz [DE]; HILLESHEIM, Elke Maria [DE]; EL QACEMI, Myriem [FR]
- (74) **Agente/apoderado:** JUAN LAPENNE DE SALTERAIN (211)
- (54) **Título:** Compuestos de azetidini-piridinilcarbonilo, pirrolidinil-piridinilcarbonilo, piperidinil-piridinil

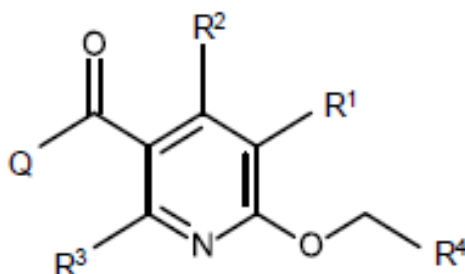

- (57) **Resumen:** Compuestos de fórmula (I) (I) en donde los sustituyentes son como se definen en la reivindicación 1 y las sales, los estereoisómeros, los enantiómeros, los tautómeros y los N-óxidos agroquímicamente aceptables de esos compuestos pueden usarse como insecticidas.

(19) Dirección Nacional de la Propiedad Industrial – URUGUAY**(12) Invención****(11) UY a/039696**

- (51) **Clasificación Internacional:** A 01N 43/86(2006.01), A 01N 43/60(2006.01), A 01N 43/40(2006.01), C 07D 403/04(2006.01), C 07D 401/14(2006.01), C 07D 417/04(2006.01), C 07D 401/04(2006.01)
- (22) **Fecha de presentación:** 28/03/2022
- (30) **Datos de prioridad:** 21181142.7 23/06/2021 EP y 202111015219 31/03/2021 IN
- (71) **Solicitante:** SYNGENTA CROP PROTECTION AG [CH]
- (72) **Inventor:** WEISS, Matthias [CH]; MAHAJAN, Atul [IN]; WILLIAMS, Simon [GB]; SEN, Indira [IN]
- (74) **Agente/apoderado:** JUAN LAPENNE DE SALTERAIN (211)
- (54) **Título:** DERIVADOS MICROBIOCIDAS DE QUINOLIN/QUINOXALIN-BENZOTIAZINA COMO AGENTES FUNGICIDAS, EN PARTICULAR C

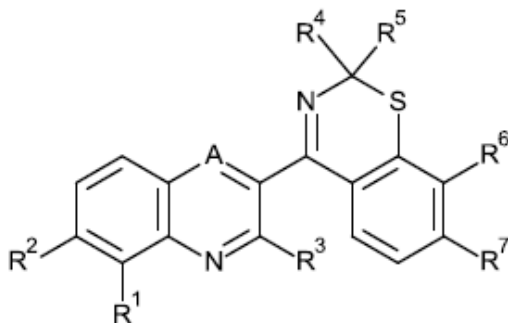

- (57) **Resumen:** Compuestos de fórmula (I): (I) en donde los sustituyentes son como se definen en la reivindicación 1, útiles como plaguicidas, especialmente como fungicidas.

(19) Dirección Nacional de la Propiedad Industrial – URUGUAY**(12) Invención****(11) UY a/039700**

- (51) **Clasificación Internacional:** C 02F 1/66(2006.01), C 02F 3/28(2006.01), C 02F 3/02(2006.01), C 02F 1/70(2006.01)
- (22) **Fecha de presentación:** 28/03/2022
- (30) **Datos de prioridad:** 20215350 26/03/2021 FI
- (71) **Solicitante:** UPM-Kymmene Corporation [FI]
- (72) **Inventor:** Dayana Travers [UY]; Ernesto de los Santos [UY]; Lorena Echevarria [UY]; Miguel Paolino [UY]; Jonathan Ragghianti [UY]; Darío Came [UY]; Gervasio GONZÁLEZ [UY]; Valentina Vignola [UY]; Maite Mendez [UY]; María Gubitosi [UY]
- (74) **Agente/apoderado:** FABIANA PENADES (216)
- (54) **Título:** MÉTODO PARA DISMINUIR LA CANTIDAD DE CLORATO EN AGUAS RESIDUALES

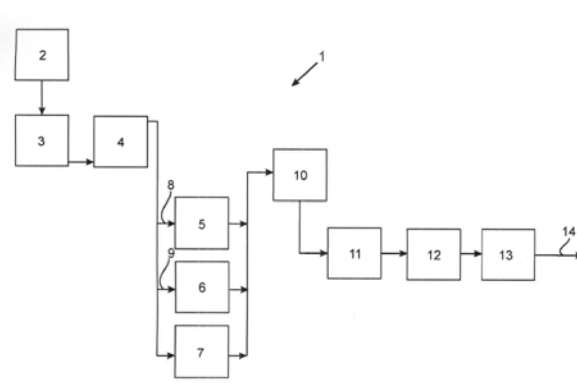

- (57) **Resumen:** Se da a conocer un método para disminuir la cantidad de clorato en aguas residuales tratadas en un proceso de tratamiento de aguas residuales (1). El proceso de tratamiento de aguas residuales se opera utilizando un sistema que comprende una laguna de igualación (5, 6, 7) a la cual al menos una parte de las aguas residuales (8, 9) es alimentada durante el proceso de tratamiento de aguas residuales, y di-cho método comprende ajustar las condiciones en la laguna de igualación (5, 6) a la cual la al menos una parte de las aguas residuales es alimentada.

(19) Dirección Nacional de la Propiedad Industrial – URUGUAY**(12) Invención****(11) UY a/039701**

- (51) **Clasificación Internacional:** C 07D 471/04(2006.01), A 61K 31/4375(2006.01), A 61P 35/00(2006.01)// A 61P 35/00
- (22) **Fecha de presentación:** 29/03/2022
- (30) **Datos de prioridad:** 63/168,456 31/03/2021 US y 63/309,346 11/02/2022 US
- (71) **Solicitante:** PFIZER INC. [US]
- (72) **Inventor:** ALLEN, Shelley [US]; BOYS, Mark Laurence [US]; DOERNER BARBOUR, Patrick Michael [US]; KELLUM, Alex Andrew [US]; REN, Li [US]; BLAKE, James Francis [US]; WITKOS, Faith Elizabeth [US]; CLARK, Wesley Dewitt [US]; COWDREY, Connor James [US]; DAHLKE, Joshua Ryan [US]; KNAPP, Ellen Margaret [US]; MORENO, David Austin [US]; O'LEARY, Jacob Matthew [US]; BLANCHE, Sydney Taylor [US]
- (74) **Agente/apoderado:** JUAN LAPENNE DE SALTERAIN (211)
- (54) **Título:** 3,4-DIHIDRO-2,7-NAFTIRIDIN-1,6(2H,7H)-DIONAS COMO INHIBIDORES DE MEK

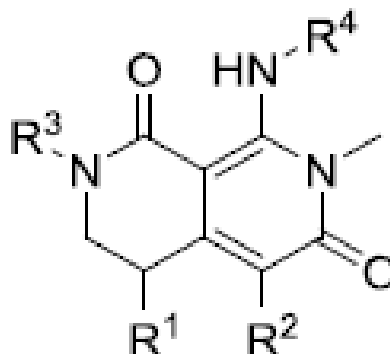

- (57) **Resumen:** La invención se refiere a un compuesto de la Fórmula I o una sal aceptable desde el punto de vista farmacéutico de este, en donde R1, R2, R3 y R4 son como se definen en la presente. La invención se refiere además a composiciones farmacéuticas que comprenden dichos compuestos y sales, y a métodos y usos de dichos compuesto, sales y composiciones para el tratamiento del crecimiento celular anormal, que incluye cáncer, en un sujeto que lo necesita. La invención se refiere además a formas sólidas de 8-((2-fluoro-4-(metiltio)fenil)amino)-2-(2-hidroxietoxi)-7-metil-3,4-dihidro-2,7-naftiridin-1,6(2H,7H)-diona.

(19) Dirección Nacional de la Propiedad Industrial – URUGUAY**(12) Invención****(11) UY a/039702**

- (51) Clasificación Internacional:** A 01N 43/10(2006.01), A 01N 43/56(2006.01), C 07D 231/14(2006.01), C 07D 409/12(2006.01)
- (22) Fecha de presentación:** 29/03/2022
- (30) Datos de prioridad:** 63/167,757 30/03/2021 US
- (71) Solicitante:** Valent BioSciences LLC [US]
- (72) Inventor:** DALE O. WILSON JR. [US]; FRANKLIN PAUL SILVERMAN [US]
- (74) Agente/apoderado:** STELLA MARINA WENG POLICICCHIO (218)
- (54) Título:** INHIBIDORES DE SUCCINATO DESHIDROGENASA PARA INTERRUMPIR LA LATENCIA

- (57) Resumen:** Métodos para promover la ruptura de brotes en plantas leñosas perennes mediante la aplicación de inhibidores de succinato deshidrogenasa. La presente invención también está dirigida a métodos para sincronizar la ruptura de brotes en plantas leñosas perennes mediante la aplicación de inhibidores de succinato deshidrogenasa. La presente invención está dirigida a métodos para promover el crecimiento en plantas leñosas perennes mediante la aplicación de inhibidores de succinato deshidrogenasa.

(19) Dirección Nacional de la Propiedad Industrial – URUGUAY

(12) Invención

(11) UY a/039703

- (51) **Clasificación Internacional:** A 01N 43/836(2006.01), A 01P 3/00(2006.01), C 07D 271/06(2006.01), C 07D 413/10(2006.01)// A 01P 3/00
- (22) **Fecha de presentación:** 29/03/2022
- (30) **Datos de prioridad:** 21165965.1 30/03/2021 EP
- (71) **Solicitante:** BAYER AKTIENGESELLSCHAFT [DE]
- (72) **Inventor:** Vincent THOMAS [FR]; Jacopo NEGRONI [IT]; Dr. Christoph Andreas BRAUN [DE]; Sophie DUCERF [FR]; Jeremy DUFOUR [FR]; Aurelie MALLINGER [FR]; Anne-Sophie REBSTOCK [FR]
- (74) **Agente/apoderado:** JUAN LAPENNE DE SALTERAIN (211)
- (54) **Título:** 3-(HETERO)ARIL-5-CLORODIFLUOROMETIL-1,2,4-OXADIAZOL COMO FUNGICIDA

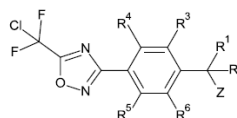
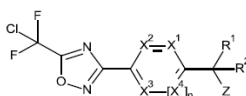

- (57) **Resumen:** La presente invención se refiere a compuestos de 3-(hetero)aril-5-clorodifluorometil-1,2,4-oxadiazol, así como a sus usos para controlar microorganismos nocivos, en particular hongos fitopatógenicos, en la protección de cultivos.

(19) Dirección Nacional de la Propiedad Industrial – URUGUAY

(12) Invención

(11) UY a/039705

- (51) **Clasificación Internacional:** C 07D 277/62(2006.01), C 07D 471/04(2006.01), C 07D 417/12(2006.01), C 07D 417/10(2006.01), C 07D 409/12(2006.01), C 07D 409/10(2006.01), C 07D 209/44(2006.01), C 07D 495/04(2006.01), C 07D 333/52(2006.01), C 07D 333/56(2006.01), A 61K 31/437(2006.01), A 61K 31/4365(2006.01), A 61K 31/428(2006.01), A 61K 31/4035(2006.01), A 61K 31/381(2006.01), A 61P 35/00(2006.01)// A 61P 35/00, C 07D 209/44, 277/62, 333/52, 333/56
- (22) **Fecha de presentación:** 29/03/2022
- (30) **Datos de prioridad:** PCT/CN2021/083783 30/03/2021 CN; PCT/CN2021/090945 29/04/2021 CN; PCT/CN2021/111479 09/08/2021 CN; PCT/CN2021/128942 05/11/2021 CN; PCT/CN2021/130097 11/11/2021 CN; PCT/CN2021/138806 16/12/2021 CN; PCT/CN2021/143043 30/12/2021 CN y PCT/CN2022/071548 12/01/2022 CN
- (71) **Solicitante:** Jacobio Pharmaceuticals Co., Ltd. [CN]
- (72) **Inventor:** Wei LONG [CN]; Yanping WANG [CN]; Fashun YAN [CN]; Xiuwei LI [CN]; Guiqun YANG [CN]; Yang YE [CN]
- (74) **Agente/apoderado:** GONZALO FERNÁNDEZ SECCO (34)
- (54) **Título:** NOVEDOSOS COMPUESTOS ÚTILES COMO AGONISTAS DE STING Y SUS USOS

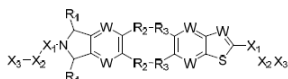
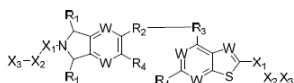
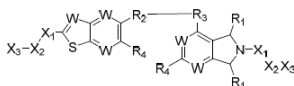
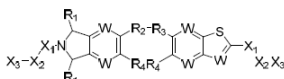
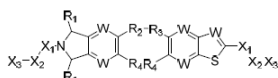

- (57) **Resumen:** Se proporcionan compuestos de la Fórmula general I, II, III, IV, V y sus sales farmacéuticamente aceptables, que pueden ser útiles como inductores de la producción de interferón tipo I, específicamente como agentes activos de STING. También se proporcionan síntesis, composiciones y usos de dichos compuestos.

(19) Dirección Nacional de la Propiedad Industrial – URUGUAY**(12) Invención****(11) UY a/039707**

- (51) **Clasificación Internacional:** A 01N 43/80(2006.01), A 01P 7/00(2006.01), C 07D 261/04(2006.01)// A 01P 7/00
- (22) **Fecha de presentación:** 30/03/2022
- (30) **Datos de prioridad:** 21166425.5 31/03/2021 EP
- (71) **Solicitante:** SYNGENTA CROP PROTECTION AG [CH]
- (72) **Inventor:** SKILLMAN, Stephen Wilson [GB]; HOPPE, Mark [GB]; VALERIM DOS SANTOS, Leandro [BR]
- (74) **Agente/apoderado:** JUAN LAPENNE DE SALTERAIN (211)
- (54) **Título:** Composición de cebo para plagas de insectos que contiene derivados de isoxazolina y método para controlarlas
- (57) **Resumen:** Una composición de cebo que comprende una cantidad insecticida eficaz de isocloseram y un material de cebo que comprende un atrayente alimenticio para insectos y/o un saborizante alimenticio para insectos. Además, la presente invención se refiere a un método para controlar una plaga de insectos o población de plagas de insectos que comprende aplicar una cantidad insecticida eficaz de dicha composición de cebo a un emplazamiento entorno de actividad de insectos conocida o probable.

(19) Dirección Nacional de la Propiedad Industrial – URUGUAY**(12) Invención****(11) UY a/039708**

- (51) **Clasificación Internacional:** A 01N 43/836(2006.01), C 07D 271/06(2006.01)
(22) **Fecha de presentación:** 30/03/2022
(30) **Datos de prioridad:** 21165970.1 30/03/2021 EP
(71) **Solicitante:** BAYER AKTIENGESELLSCHAFT [DE]
(72) **Inventor:** DUFOUR, Jeremy [FR]; THOMAS, Vincent [FR]; MALLINGER, Aurelie [FR]; NEGRONI, Jacopo [FR]; DUCERF, Sophie [FR]; REBSTOCK, Anne-Sophie francia [FR]; BRAUN, Christoph Andreas [DE]
(74) **Agente/apoderado:** JUAN LAPENNE DE SALTERAIN (211)
(54) **Título:** 3-(HETERO)ARIL-5-CLORODIFLUOROMETIL-1,2,4-OXADIAZOL COMO FUNGICIDA

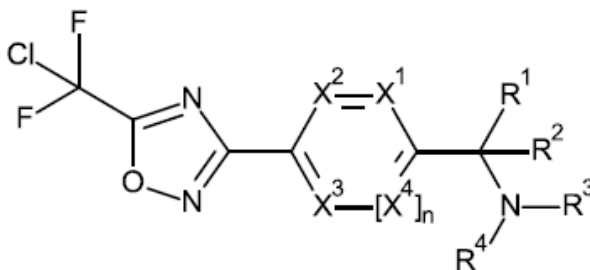

- (57) **Resumen:** La presente invención se refiere a compuestos de 3-(hetero)aril-5-clorodifluorometil-1,2,4-oxadiazol, así como a sus usos para controlar microorganismos nocivos, en particular hongos fitopatógenicos, en la protección de cultivos.

(19) Dirección Nacional de la Propiedad Industrial – URUGUAY

(12) Invención

(11) UY a/039709

- (51) **Clasificación Internacional:** A 01N 43/40(2006.01), A 01N 43/54(2006.01), A 01N 43/56(2006.01), A 01N 43/58(2006.01), A 01N 43/60(2006.01), C 07D 401/14(2006.01), C 07D 403/14(2006.01), C 07D 487/04(2006.01)
- (22) **Fecha de presentación:** 31/03/2022
- (30) **Datos de prioridad:** 202111015042 31/03/2021 IN
- (71) **Solicitante:** PI INDUSTRIES LTD [IN]
- (72) **Inventor:** Alexander G.M. Klausener [DE]; Gagan Kukreja [IN]; Ankur Aniruddh Upadhyay [IN]; Rohit Niraniya [IN]; Narasimha Murthy Cheemala [IN]
- (74) **Agente/apoderado:** GUSTAVO LARROSA DE BRUN (179)
- (54) **Título:** COMPUESTOS HETEROCÍCLICOS CONDENSADOS Y SU USO COMO AGENTES DE CONTROL DE PLAGAS.

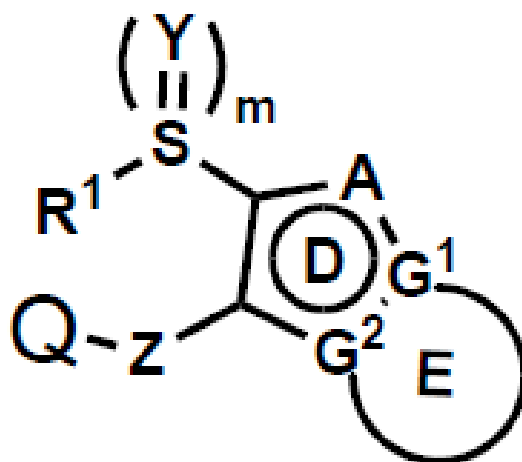

- (57) **Resumen:** La presente invención desvela un compuesto heterocíclico condensado de fórmula (I), en donde, Q, R1, Z, A, G1, G2, E, Y y m, son como se definen en la descripción detallada. La presente invención desvela además métodos para su preparación y el uso de los compuestos de fórmula (I) como agente de control de plagas.

(19) Dirección Nacional de la Propiedad Industrial – URUGUAY**(12) Invención****(11) UY a/039711**

- (51) Clasificación Internacional:** A 01N 63/00, A 01N 63/02, C 07K 14/435, C 12N 1/19, C 12N 15/11, C 12N 15/82
- (22) Fecha de presentación:** 31/03/2022
- (30) Datos de prioridad:** US 63/169,643 01/04/2021 US
- (71) Solicitante:** VESTARON CORPORATION [US]
- (72) Inventor:** BAO, Lin [US]; SCHNEIDER, Kyle Douglas [US]; DAVIS, Breck [US]
- (74) Agente/apoderado:** CARLOS E, SARLABÓS BUZÓ (BRAND UP S.A.S. 218974190018) (189)
- (54) Título:** POLIPÉPTIDOS CON MUTACIONES DE Av3 PARA EL CONTROL DE PLAGAS

- (57) Resumen:** Se describen nuevos péptidos insecticidas, polipéptidos, proteínas y nucleótidos; su expresión en cultivos y plantas; métodos de producción de péptidos, polipéptidos, proteínas y nucleótidos; nuevos procesos; nuevas técnicas de producción, nuevas formulaciones y nuevos organismos. La 5 presente descripción también está relacionada con los mutantes denominados polipéptidos con mutaciones de Av3 (AMP) que son una forma modificada no natural del péptido, Av3, aislado de la anémona de mar, Anemonia viridis. Aquí describimos: los polinucleótidos que codifican AMP; diversas formulaciones y combinaciones de polinucleótidos y péptidos; y métodos para usarlos que son útiles para el control de insectos.

(19) Dirección Nacional de la Propiedad Industrial – URUGUAY**(12) Invención****(11) UY a/039712**

- (51) Clasificación Internacional:** A 01N 43/828(2006.01), A 01N 57/20(2006.01), C 07D 271/12(2006.01)
- (22) Fecha de presentación:** 31/03/2022
- (30) Datos de prioridad:** 63/170,265 02/04/2021 US y 63/188,837 14/05/2021 US
- (71) Solicitante:** THE BOARD OF TRUSTEES OF THE UNIVERSITY OF ARKANSAS [US]
- (72) Inventor:** Grant Lawson PRIESS [US]; Jason Keith NORSWORTHY [US]
- (74) Agente/apoderado:** GONZALO FERNÁNDEZ SECCO (34)
- (54) Título:** COMBINACIONES DE AGROQUÍMICOS CON INHIBIDORES METABÓLICOS

- (57) Resumen:** Se describen combinaciones que comprenden un agroquímico y un inhibidor metabólico. Se describen además métodos para mejorar la eficacia de un agroquímico al utilizarlo en combinación con un inhibidor metabólico. Se describen además métodos para controlar un pasto o una maleza de hoja ancha en un cultivo utilizando las combinaciones descritas en la presente invención.

(19) Dirección Nacional de la Propiedad Industrial – URUGUAY**(12) Invención****(11) UY a/039713**

- (51) Clasificación Internacional:** C 12N 15/113(2010.01), C 12N 15/11(2006.01), A 61K 48/00(2006.01), A 61P 25/00(2006.01)// A 61P 25/00
- (22) Fecha de presentación:** 31/03/2022
- (30) Datos de prioridad:** 63/169.539 01/04/2021 US
- (71) Solicitante:** Biogen MA Inc. [US]
- (72) Inventor:** Hasan M. YILDIZ [US]; Mandana BORNAPOUR [CA]; William F. KIESMAN [US]; Vishwesh A. PATIL [IN]; Brian R. SIMLER [US]; Paul PENG [US]
- (74) Agente/apoderado:** SUSANA DEL CERRO (136)
- (54) Título:** ADMINISTRACION DE ACIDO NUCLEICO AL SISTEMA NERVIOSO CENTRAL

- (57) Resumen:** Se presentan nanoportadores poliméricos (p. ej., nanopartículas de PLGA) con ácido nucleico encapsulado (p. ej., un oligonucleótido antisentido) para la administración (p. ej., por vía intratecal) al sistema nervioso central. Estos nanoportadores poliméricos son útiles en el tratamiento de trastornos del sistema nervioso central. Son capaces de administrar su carga (p. ej., un oligonucleótido antisentido) en cantidades mayores, durante un período de tiempo más largo y en regiones más profundas del cerebro que un oligonucleótido antisentido libre o no formulado. La administración y distribución eficientes del oligonucleótido antisentido resulta en la reducción del número de administraciones.

(19) Dirección Nacional de la Propiedad Industrial – URUGUAY**(12) Invención****(11) UY a/039714**

- (51) Clasificación Internacional:** C 07K 14/31(2006.01), A 61K 39/085(2006.01), A 61P 31/04(2006.01)// A 61P 31/04
- (22) Fecha de presentación:** 01/04/2022
- (30) Datos de prioridad:** 63/170,089 02/04/2021 US y 63/249,452 28/09/2021 US
- (71) Solicitante:** JANSSEN PHARMACEUTICALS, INC. [US] y NEW YORK UNIVERSITY [US]
- (72) Inventor:** Jinqun LUO [US]; Jeroen GEURTSSEN [NL]; Brian MORROW [US]; Jan POOLMAN [NL]; Sandeep SOMANI [IN]; Peter BUCKLEY [US]; Victor TORRES [US]; Sergey KONSTANTINOV [NL]
- (74) Agente/apoderado:** GONZALO FERNÁNDEZ SECCO (34)
- (54) Título:** COMPOSICIONES DE VACUNA DE STAPHYLOCOCCUS AUREUS

- (57) Resumen:** La presente divulgación se refiere a composiciones inmunogénicas para inducir una respuesta inmune en un sujeto para el tratamiento y/o la prevención de una infección de Staphylococcus aureus. Las composiciones inmunogénicas que se describen en el presente documento comprenden un polipéptido A (SpA) de la proteína A de S. aureus y una leucocidina A de S. aureus (LukA) y/o polipéptido variante de leucocidina B (LukB). La presente divulgación se refiere además a métodos para generar una respuesta inmune contra S. aureus en un sujeto que implica administrar las composiciones inmunogénicas reveladas.

(19) Dirección Nacional de la Propiedad Industrial – URUGUAY**(12) Invención****(11) UY a/039715**

(51) Clasificación Internacional: C 07K 16/30(2006.01), C 07K 16/28(2006.01), A 61K 39/395(2006.01), A 61P 35/00(2006.01)// A 61P 35/00

(22) Fecha de presentación: 01/04/2022

(30) Datos de prioridad: 63/170,383 02/04/2021 US y 63/239,883 01/09/2021 US

(71) Solicitante: TENEOBIO, Inc. [US]

(72) Inventor: Nathan TRINKLEIN [US]; Katherine HARRIS [US]; Kaitlyn LOUGHLIN [IE]; Harbani Kaur MALIK CHAUDHRY [IN]; Kyle LORENTSEN [US]

(74) Agente/apoderado: STELLA MARINA WENG POLICICCHIO (218)

(54) Título: ANTICUERPOS ANTI-IL-2R AGONISTAS Y MÉTODOS DE USO

(57) Resumen: Se describen anticuerpos anti-IL2R (por ejemplo, anti-IL2RB, anti-IL2RG, anti IL2RB/G), junto con métodos para elaborar tales anticuerpos, composiciones, inclusive composiciones farmacéuticas, que comprenden tales anticuerpos, y el uso de tales anticuerpos y composiciones en el tratamiento de enfermedades y trastornos mediados por la vía de señalización de IL2/IL2R.

(19) Dirección Nacional de la Propiedad Industrial – URUGUAY**(12) Invención****(11) UY a/039716**

- (51) **Clasificación Internacional:** A 01N 37/24(2006.01), A 01N 47/02(2006.01), A 01N 47/34(2006.01), A 01P 7/00(2006.01), A 01P 7/04(2006.01)
- (22) **Fecha de presentación:** 04/04/2022
- (30) **Datos de prioridad:** 202111028811 26/06/2021 IN; 202131015784 02/04/2021 IN y 202131015786 02/04/2021 IN
- (71) **Solicitante:** Adama Makhteshim Ltd. [IL]
- (72) **Inventor:** Pradeep KULKARNI [IN]; Dor KESTECHER [IL]; Ernesto BENETTI [BR]; Mariela FAURE MLYNSKI [IL]; Carlos Bruno PENNA BETTARELLO [BR]; Cristiane Stecca TURATTI [BR]; Juliano UEBEL [BR]
- (74) **Agente/apoderado:** JUAN LAPENNE DE SALTERAIN (211)
- (54) **Título:** Combinaciones novedosas de compuestos activos de novalurón, al menos un compuesto activo adicional, métodos para controlar plagas aplicando dichas combinaciones

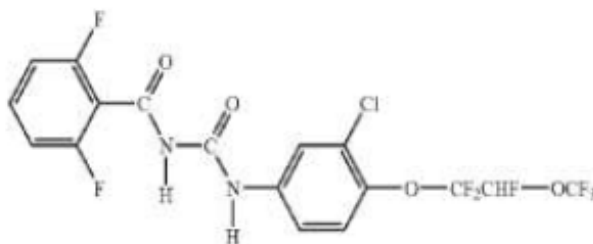

- (57) **Resumen:** La presente invención se refiere a combinaciones novedosas de compuestos activos que comprenden novaluron y al menos un compuesto activo adicional, y a métodos para el control de plagas, que comprenden aplicar dichas combinaciones.

(19) Dirección Nacional de la Propiedad Industrial – URUGUAY**(12) Invención****(11) UY a/039721**

- (51) Clasificación Internacional:** A 01H 5/00, A 01H 5/10, A 01N 63/02
(22) Fecha de presentación: 08/04/2022
(30) Datos de prioridad: 63/174,191 13/04/2021 US
(71) Solicitante: BASF Agricultural Solutions Seed US LLC [US]
(72) Inventor: Michael McCarville [US]; Rodrigo Moreira Saraiva [BR]; Julia Daum [US]
(74) Agente/apoderado: DIEGO DUFRECHU RODRIGUEZ (192)
(54) Título: SUPRESIÓN DE NEMATODOS

- (57) Resumen:** La presente divulgación se refiere a métodos de supresión de nematodos. Además, se proporcionan métodos para aumentar el rendimiento de una planta sensible a nematodos.

(19) Dirección Nacional de la Propiedad Industrial – URUGUAY**(12) Invención****(11) UY a/039724**

- (51) Clasificación Internacional:** C 07K 16/28(2006.01), C 07K 16/30(2006.01), A 61P 35/00(2006.01)// A 61P 35/00
- (22) Fecha de presentación:** 08/04/2022
- (30) Datos de prioridad:** 2021109765 08/04/2021 RU
- (71) Solicitante:** Joint - Stock Company "BIOCAD" [RU]
- (72) Inventor:** MOROZOV, Dmitry Valentinovich [RU]; KRYUKOV, Fedor Borisovich [RU]; FOGT, Sergei Nikolaevich [RU]; SHUSTOVA, Mariia Stanislavovna [RU]
- (74) Agente/apoderado:** GONZALO FERNÁNDEZ SECCO (34)
- (54) Título:** MÉTODO PARA TRATAR UNA NEOPLASIA MALIGNA MEDIANTE LA COMBINACIÓN DE UN ANTICUERPO CONTRA PD-1 Y UN A
- (57) Resumen:** La presente invención se refiere al uso del anticuerpo contra PD-1, en particular prolgolimab, en combinación con al menos un agente quimioterapéutico, en particular paclitaxel, carboplatino o cisplatino, para tratar una neoplasia maligna, y al uso del anticuerpo contra PD-1 prolgolimab en combinación con el anticuerpo contra VEGF, en particular bevacizumab, y al menos un agente quimioterapéutico, en particular paclitaxel, carboplatino o cisplatino, para tratar una neoplasia maligna.

(19) Dirección Nacional de la Propiedad Industrial – URUGUAY

(12) Invención

(11) UY a/039729

- (51) Clasificación Internacional: C 07C 31/08(2006.01), C 07C 29/80(2006.01)
(22) Fecha de presentación: 19/04/2022
(30) Datos de prioridad: PCT/FI2021/050286 19/04/2021 FI
(71) Solicitante: UPM-Kymmene Corporation [FI]
(72) Inventor: Isko Kajanto [FI]
(74) Agente/apoderado: FABIANA PENADES (216)
(54) Título: RECUPERACIÓN DE MONOETILENGLICOL

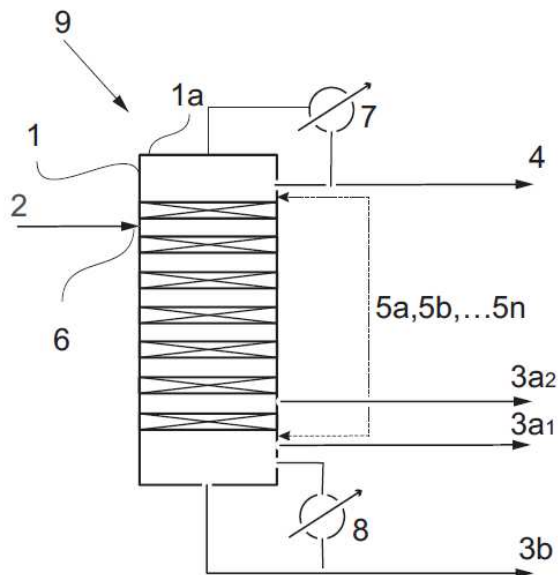

- (57) Resumen: Se da a conocer un método para recuperar monoetilenglicol a partir de una alimentación de una mezcla que comprende dioles derivados de biomasa. El método comprende: - suministrar la alimentación de la mezcla a una columna de destilación, siendo que la columna de destilación comprende al menos 80 etapas teóricas y siendo que la alimentación de la mezcla se alimenta a la columna de destilación en un punto [situado] a una altura de 5 – 20 % de la altura total de la columna de destilación, calculada a partir del extremo superior de la columna de destilación.

(19) Dirección Nacional de la Propiedad Industrial – URUGUAY**(12) Invención****(11) UY a/039733**

- (51) **Clasificación Internacional:** A 01B 49/04(2006.01), C 02F 11/02(2006.01)
 (22) **Fecha de presentación:** 20/04/2022
 (30) **Datos de prioridad:** 2021901173 20/04/2021 AU
 (71) **Solicitante:** Wagstaff Food Services Pty Ltd [AU]
 (72) **Inventor:** James Henry Ralph [AU]; Joel James McLean [AU]; David William McLean [AU]
 (74) **Agente/apoderado:** MATIAS CIKATO (201)
 (54) **Título:** APLICACIÓN DE MICROONDAS A ANIMALES

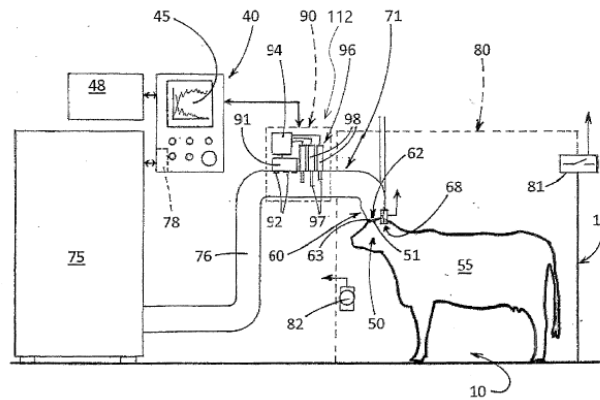

- (57) **Resumen:** Métodos y aparatos para inducir la inconsciencia por calentamiento del cerebro de un animal (55) aplicando radiación de microondas por un aplicador (60). Un concentrador de flujo electromagnético comprende una sección tubular (61) y al menos una cresta (65) interna extendiéndose longitudinalmente. El aplicador (60) se preajusta dirigiendo la radiación de microondas de baja potencia a través de él a una carga que aproxima a las propiedades de la cabeza del animal, ajustando la impedancia del aplicador optimizando la coincidencia de impedancias. Un compensador (110) asociado a la guía de ondas (76) compensa los cambios en la potencia reflejada detectada.

(19) Dirección Nacional de la Propiedad Industrial – URUGUAY**(12) Invención****(11) UY a/039734**

- (51) Clasificación Internacional:** C 07K 16/30, C 07K 16/28, A 61K 39/395, A 61P 35/00// A 61P 35/00
- (22) Fecha de presentación:** 21/04/2022
- (30) Datos de prioridad:** 63/177,518 21/04/2021 US; 63/180,690 28/04/2021 US y 63/309,230 11/02/2022 US
- (71) Solicitante:** JANSSEN BIOTECH, INC. [US]
- (72) Inventor:** Satyen Torne [US]; Roland Knoblauch [US]
- (74) Agente/apoderado:** DIEGO DUFRECHU RODRIGUEZ (192)
- (54) Título:** FORMULACIONES DE ANTICUERPOS BIESPECÍFICOS DE ALTA CONCENTRACIÓN

- (57) Resumen:** En la presente descripción se proporcionan composiciones farmacéuticas acuosas estables que comprenden formulaciones de alta concentración de un anticuerpo biespecífico del receptor del factor de crecimiento epidérmico (EGFR)/receptor del factor de crecimiento de hepatocitos (c-Met) y métodos para preparar las mismas. En la presente descripción también se proporcionan métodos para tratar el cáncer en un sujeto que lo necesita mediante la administración por vía subcutánea al sujeto de composiciones farmacéuticas acuosas estables como se describe en la presente descripción.

(19) Dirección Nacional de la Propiedad Industrial – URUGUAY**(12) Invención****(11) UY a/039736**

- (51) Clasificación Internacional:** C 07K 16/24(2006.01), A 61P 29/00(2006.01)
// A 61P 29/00
- (22) Fecha de presentación:** 27/04/2022
- (30) Datos de prioridad:** 63/178,938 23/04/2021 US
- (71) Solicitante:** AMGEN INC. [US]
- (72) Inventor:** Marisa Joubert [US]; Dong Xiang [US]; Hao Zhang [US]; Kelly Fitzpatrick [US]; Alla Polozova [US]; Kristin Abrams [US]
- (74) Agente/apoderado:** FABIANA PENADES (216)
- (54) Título:** COMPOSICIONES DE ANTICUERPOS ANTI-TSLP Y USOS DE LOS MISMOS
- (57) Resumen:** La presente solicitud se refiere, en general, a composiciones que comprenden el anticuerpo anti-TSLP tezepelumab y derivados del mismo que tienen atributos de calidad de los anticuerpos.

(19) Dirección Nacional de la Propiedad Industrial – URUGUAY**(12) Invención****(11) UY a/039930**

- (51) **Clasificación Internacional:** A 61J 11/04(2006.01), A 61J 11/00(2006.01)
(22) **Fecha de presentación:** 06/09/2022
(30) **Datos de prioridad:** 61/844,557 10/07/2013 US
(71) **Solicitante:** HANDI-CRAFT COMPANY [US]
(72) **Inventor:** RHODES, Scott [US]; MILLER, Charles H. [US]; KEMPER, Bernard J. [US]
(74) **Agente/apoderado:** JUAN LAPENNE DE SALTERAIN (211)
(54) **Título:** CONJUNTO DE BOTELLA QUE INCLUYE CONJUNTO DE VENTILACIÓN DE CONFIGURACIÓN DUAL

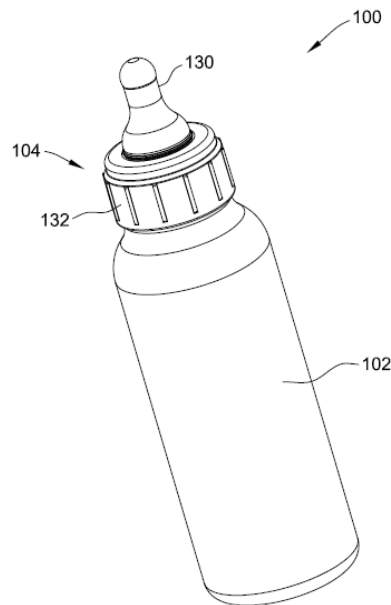

- (57) **Resumen:** Un conjunto de botella incluye un recipiente y un conjunto de ventilación que se posiciona al menos en parte de un borde del recipiente. Un conjunto de cuello sustancialmente define un cierre para el recipiente y se acopla de manera separable con un cuello del recipiente. El conjunto de cuello y el conjunto de ventilación están configurados uno con respecto al otro para permitir la configuración selectiva entre una primera configuración y una segunda configuración.

(19) Dirección Nacional de la Propiedad Industrial – URUGUAY**(12) Invención****(11) UY a/039938**

- (51) **Clasificación Internacional:** C 08J 5/18(2006.01), C 08L 5/00(2006.01), A 23P 20/10(2016.01), B 65D 65/46(2006.01)
- (22) **Fecha de presentación:** 09/09/2022
- (30) **Datos de prioridad:** P202130851 13/09/2021 ES
- (71) **Solicitante:** VISCOFAN, S.A. [ES]
- (72) **Inventor:** ROJAS GRAU, Maria Alejandra [ES]; ARRARAS ILUNDAIN, Jose Angel [ES]; FERON, Bernhard [DE]
- (74) **Agente/apoderado:** Juan Eduardo Vanrell Falcon (144)
- (54) **Título:** SOLUCIÓN FORMADORA DE FILM COMESTIBLE TRANSFERENTE DE ESPECIAS, FILM Y PROCEDIMIENTO DE OBTENCIÓN *

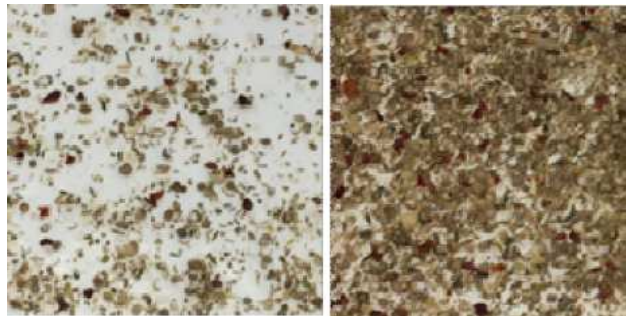

- (57) **Resumen:** La presente invención se refiere a una solución formadora de un film comestible, así como al film comestible capaz de transferir especias de diferentes pesos, tamaños y formas a la superficie de un alimento y desintegrarse completamente en contacto con la humedad del producto donde es aplicado, dejando visible únicamente la capa de especias contenida en dicho film. Igualmente se refiere al procedimiento de obtención del mismo y a los usos dados al mismo.

(19) Dirección Nacional de la Propiedad Industrial – URUGUAY**(12) Invención****(11) UY a/039946**

- (51) **Clasificación Internacional:** A 01H 1/00(2006.01), A 01H 5/00(2018.01), C 12N 5/10(2006.01)
- (22) **Fecha de presentación:** 15/09/2022
- (30) **Datos de prioridad:** 61/697,886 07/09/2012 US
- (71) **Solicitante:** DOW AGROSCIENCES LLC [US] y SANGAMO BIOSCIENCES, INC. [US]
- (72) **Inventor:** Noel Cogan [US]; John Forster [US]; Matthew Hayden [US]; Tim Sawbridge [US]; German Spangenberg [US]; Dmitry Y. Guschin [US]; Manju Gupta [US]; W. Mike Ainley [US]; Matthew J. Henry [US]; Jeffrey C. Miller [US]; Steven R. Webb [US]
- (74) **Agente/apoderado:** NORA MORGADE DI POLITO (165)
- (54) **Título:** DESEMPEÑO DE UBICACIÓN DE FAD2 Y SU CORRESPONDIENTE SITIO DE INCIDENCIA ESPECÍFICA DE LAS ...*
- (57) **Resumen:** Se divulga un método de edición de gen o de apilación de gen dentro de la ubicación FAD2 al escindir, en un sitio de modo directo, una ubicación en el gen FAD2 en una célula, para generar una ruptura en el gen FAD2 y luego ligar en dicha ruptura una molécula de ácido nucleico vinculada con uno o más fenotipos de interés.

(19) Dirección Nacional de la Propiedad Industrial – URUGUAY**(12) Invención****(11) UY a/039961**

- (51) **Clasificación Internacional:** G 09B 5/06(2006.01), F 16M 11/04(2006.01), A 47B 21/00(2006.01)
- (22) **Fecha de presentación:** 26/09/2022
- (30) **Datos de prioridad:**
- (71) **Solicitante:** Romer Santiago [VE]
- (72) **Inventor:** Romer Jeffrey Santiago Camacho [VE]
- (74) **Agente/apoderado:** romer santiago ()
- (54) **Título:** SOPORTE DE NOTEBOOK MAS SOPORTE DE PROYECTOR INTEGRADO

Soporte trípode de Notebook + Proyector

1. **Trípode**
2. **Bandeja principal**
3. **Bandeja para proyector**
4. **Soporte de bandeja de proyector**
5. **Borde elevado de protección**

- (57) **Resumen:** Al momento de dictar una conferencia o presentación siempre resulta necesaria una mesa amplia para colocar la notebook, proyector y demás utensilios. Con el soporte de notebook + proyector propuesto se ahorra mucho espacio, está ideado para colocar notebook y proyector en un mismo aparato, regular la altura, modificar el ángulo de proyección y es portátil, fácil de transportar. Comúnmente optimizar el ángulo de proyección resulta complejo, haciendo necesario buscar algún objeto que permita adaptarlo. Gracias a este soporte integrado se tardará menos de 5 minutos en instalar la laptop y el proyector de manera rápida y segura.

(19) Dirección Nacional de la Propiedad Industrial – URUGUAY**(12) Invención****(11) UY a/039963**

- (51) **Clasificación Internacional:** A 01N 37/22(2006.01), A 01N 43/653(2006.01), C 07C 317/24(2006.01), C 07D 249/12(2006.01)
- (22) **Fecha de presentación:** 28/09/2022
- (30) **Datos de prioridad:** 611185,363 09/06/2009 US
- (71) **Solicitante:** Arysta LifeScience Corporation [JP]
- (72) **Inventor:** JOAO M . MIYASAKI [BR]; NOEL BURCHELL LEIBBRANDT [ZA]; HIDEO NAKATANI [JP]
- (74) **Agente/apoderado:** NORA MORGADE DI POLITO (165)
- (54) **Título:** COMPOSICIONES HERBICIDAS A BASE DE CARBAMOÍLTRIAZOLINONA Y MÉTODOS DE USO

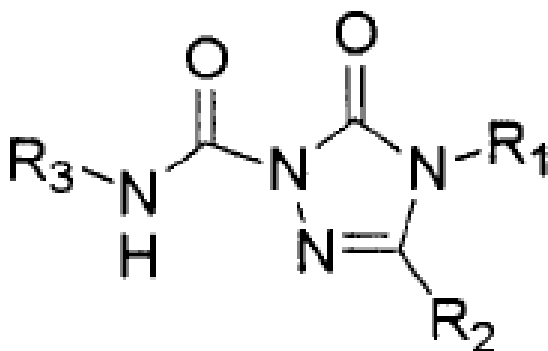

- (57) **Resumen:** La invención se refiere a combinaciones de compuestos con actividad herbicida que comprende carbamoiltriaolinonas y compuestos herbicidamente activos cuyas combinaciones son apropiadas para el control de malezas

SOLICITUDES DE DISEÑOS INDUSTRIALES

(19) Dirección Nacional de la Propiedad Industrial – URUGUAY

(12) Diseño Industrial

(11) UY s/004945

- (51) **Clasificación Internacional:** A 47K 5/00(2006.01)23-08
(22) **Fecha de presentación:** 06/04/2022
(30) **Datos de prioridad:** 29/810,551 06/10/2021 US
(71) **Solicitante:** SPARTAN CHEMICAL COMPANY, INC. [US]
(72) **Inventor:** SCHALITZ, William J. [US]; GENORD, Daniel [US]; PARKER, Grey [US]; NATARAJAN, Prasanna [US]
(74) **Agente/apoderado:** FABIANA PENADES (216)
(54) **Título:** MODELO INDUSTRIAL DE ENSAMBLAJE DE SOPORTE DE DISPENSADOR DE JABÓN

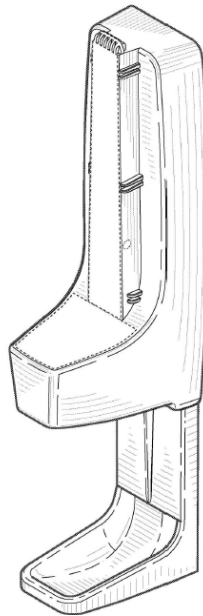

- (57) **Resumen:** La presente invención se refiere a un Modelo Industrial de Ensamblaje de Soporte de Dispensador de Jabón, totalmente diferente de los conocidos, caracterizándose por su forma especial y ornato que le proporcionan un aspecto peculiar y propio.

(19) Dirección Nacional de la Propiedad Industrial – URUGUAY**(12) Diseño Industrial****(11) UY s/004946**

- (51) Clasificación Internacional:** A 47K 5/06(2006.01)23-08
(22) Fecha de presentación: 06/04/2022
(30) Datos de prioridad: 29/810,547 06/10/2021 US
(71) Solicitante: SPARTAN CHEMICAL COMPANY, INC. [US]
(72) Inventor: SCHALITZ, William J. [US]; GENORD, Daniel [US]; PARKER, Grey [US]; NATARAJAN, Prasanna [US]
(74) Agente/apoderado: FABIANA PENADES (216)
(54) Título: MODELO INDUSTRIAL DE DISPENSADOR DE JABÓN



- (57) Resumen:** La presente invención se refiere a un Modelo Industrial de Dispensador de Jabón, totalmente diferente de los conocidos, caracterizándose por su forma especial y ornato que le proporcionan un aspecto peculiar y propio.

(19) Dirección Nacional de la Propiedad Industrial – URUGUAY**(12) Diseño Industrial****(11) UY s/004947**

- (51) **Clasificación Internacional:** A 47K 5/00(2006.01)23-08
(22) **Fecha de presentación:** 06/04/2022
(30) **Datos de prioridad:** 29/810,548 06/10/2021 US
(71) **Solicitante:** SPARTAN CHEMICAL COMPANY, INC. [US]
(72) **Inventor:** SCHALITZ, William J. [US]; GENORD, Daniel [US]; PARKER, Grey [US]; NATARAJAN, Prasanna [US]
(74) **Agente/apoderado:** FABIANA PENADES (216)
(54) **Título:** MODELO INDUSTRIAL DE SOPORTE DISPENSADOR DE JABÓN

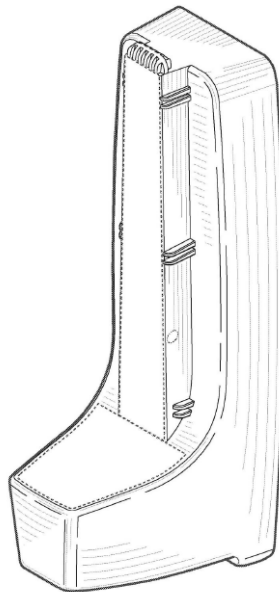

- (57) **Resumen:** La presente invención se refiere a un Modelo Industrial de Soporte dispensador de jabón, totalmente diferente de los conocidos, caracterizándose por su forma especial y ornato que le proporcionan un aspecto peculiar y propio.

(19) Dirección Nacional de la Propiedad Industrial – URUGUAY**(12) Diseño Industrial****(11) UY s/004948**

- (51) **Clasificación Internacional:** H 01R 35/02(2006.01)13-03
(22) **Fecha de presentación:** 19/04/2022
(30) **Datos de prioridad:** 29/811,979 18/10/2021 US
(71) **Solicitante:** Apple Inc. [US]
(72) **Inventor:** Jody AKANA [US]; Nicholas Pedro LYLYK [AR]; Bartley K. ANDRE [US]; Shota AOYAGI [JP]; Anthony Michael ASHCROFT [FR]; Marine C. BATAILLE [FR]; Jeremy BATAILLOU [FR]; Abidur Rahman CHOWDHURY [GB]; Clara Geneviève Marine COURTAIGNE [FR]; Markus DIEBEL [DE]; Jonathan GOMEZ GARCIA [FR]; M. Evans HANKEY [US]; Richard P. HOWARTH [GB]; Peter RUSSELL-CLARKE [AU]; Benjamin Andrew SHAFFER [US]; Clement TISSANDIER [FR]; Eugene Antony WHANG [CA]; Julian JAEDE [DD]; Duncan Robert KERR [GB]; Kainoa KWON-PEREZ [US]; Molly ANDERSON [GB]
(74) **Agente/apoderado:** FABIANA PENADES (216)
(54) **Título:** CONECTOR

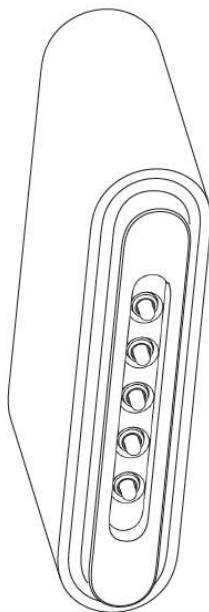

- (57) **Resumen:** Se presenta Diseño Industrial de un CONECTOR

SOLICITUDES DE MODELOS DE UTILIDAD

(19) Dirección Nacional de la Propiedad Industrial – URUGUAY

(12) Modelo de Utilidad

(11) UY u/004823

- (51) **Clasificación Internacional:** A 47G 21/18(2006.01)
(22) **Fecha de presentación:** 07/10/2021
(30) **Datos de prioridad:** BR202021004529-4 10/03/2021 BR
(71) **Solicitante:** PMI South America Consumer Goods, Ltda. [BR]
(72) **Inventor:** Alex Monteiro Botelho [BR]
(74) **Agente/apoderado:** JUAN LAPENNE DE SALTERAIN (211)
(54) **Título:** DISPOSITIVO TUBULAR PARA EL CONSUMO DE UNA INFUSIÓN

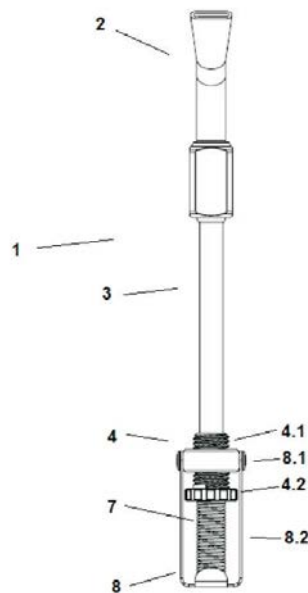

- (57) **Resumen:** El presente modelo de utilidad se refiere a un dispositivo tubular (1) para el consumo de una infusión, el cual está compuesto por: un primer extremo (2) configurado para expulsar la infusión a partir del dispositivo tubular (1) hacia un consumidor; una sección intermedia (3); y una sección final (5) dotada de al menos un agujero (6), la cual está configurada para, mediante una acción de succión del consumidor, extraer la infusión de un recipiente hacia el interior del dispositivo tubular (1) a través de al menos un agujero (6).

(19) Dirección Nacional de la Propiedad Industrial – URUGUAY**(12) Modelo de Utilidad****(11) UY u/004851**

- (51) **Clasificación Internacional:** B 65D 88/32(2006.01), B 65D 88/26(2006.01)
(22) **Fecha de presentación:** 15/09/2022
(30) **Datos de prioridad:**
(71) **Solicitante:** IGNACIO RODRIGUEZ TRAMBAUER [UY]
(72) **Inventor:** IGNACIO MARIA RODRIGUEZ TRAMBAUER [UY]
(74) **Agente/apoderado:** Ignacio Rodriguez ()
(54) **Título:** Tolva móvil, apilable, autodescargable y autolimpiante para uso con horquillas de montacargas

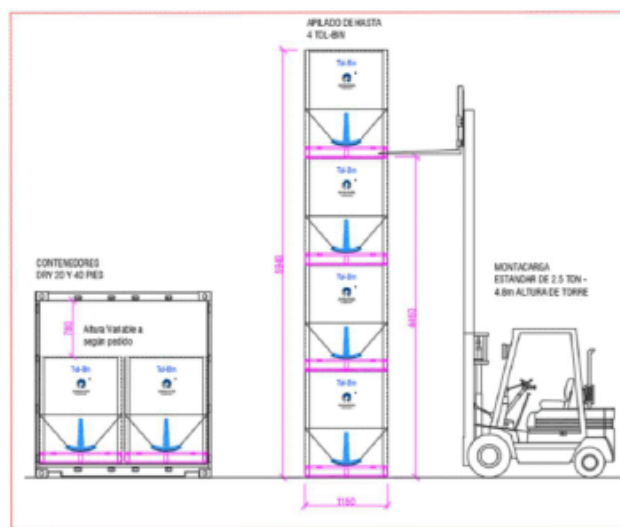

- (57) **Resumen:** Contenedor tolva de graneles de fondo cónico de medidas con estructura, base y tapa de medidas estandarizadas, de 1.150mm Largo x 1.150mm Ancho y una altura de 1.500 mm de altura, móvil, apilable, auto descargable y auto limpiante para uso con horquillas del tipo las que usan los montacargas industriales o los cargadores frontales de maquinaria agrícola. El método de fabricación puede ser: mediante corte, pliegue y soldadura de piezas o prefabricación de partes y estas ser ensambladas mediante tornillería previamente definida para tal fin, tal como si fuera un juego de partes y componentes para armar.

(19) Dirección Nacional de la Propiedad Industrial – URUGUAY**(12) Modelo de Utilidad****(11) UY u/004852**

- (51) **Clasificación Internacional:** F 16M 11/04(2006.01), F 16M 11/42(2006.01), F 16M 11/24(2006.01), A 47B 97/04(2006.01)
- (22) **Fecha de presentación:** 23/09/2022
- (30) **Datos de prioridad:**
- (71) **Solicitante:** romer santiago [VE]
- (72) **Inventor:** Romer Jeffrey Santiago Camacho [VE]
- (74) **Agente/apoderado:** romer santiago ()
- (54) **Título:** SOPORTE DE PIE MÓVIL PARA TELEVISIÓN

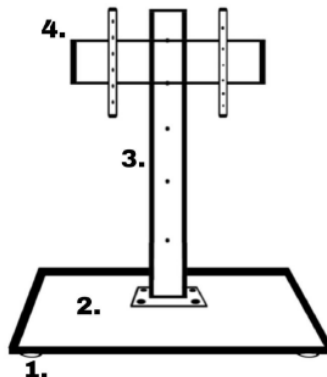
Vista frontal modelo "R-desk"

- 1. Regatones**
2. Base
3. Columna de montaje (pedestal).
4. Soporte para televisión

- (57) **Resumen:** El soporte para televisores tradicionales se encuentra limitado ya que no puede desplazarse de un lugar a otro fácilmente. El soporte para televisores con ruedas propuestos tiene la facilidad de poder trasladarlo de manera segura y sencilla a donde uno desee. Siendo de fácil instalación y sin generar esfuerzos gracias a sus ruedas y la seguridad de sus frenos. Como otra de sus ventajas se destaca la solución de uno de los problemas más comunes a nivel usuario teniendo que perforar paredes para la colocación de soportes tradicionales. Con este sistema se evita dañar la pared y hacer perforaciones innecesarias; logrando así ahorrar espacio, pudiendo seleccionar una buena regulación de su altura, y adaptándose a cualquier marca y modelo de televisores, tanto en pantallas planas como curvas.

(19) Dirección Nacional de la Propiedad Industrial – URUGUAY**(12) Modelo de Utilidad****(11) UY u/004853**

- (51) Clasificación Internacional: B 43L 1/04(2006.01), A 47B 97/04(2006.01)
(22) Fecha de presentación: 23/09/2022
(30) Datos de prioridad:
(71) Solicitante: romer santiago [VE]
(72) Inventor: Romer Jeffrey Santiago Camacho [VE]
(74) Agente/apoderado: romer santiago ()
(54) Título: Pizarra móvil magnética

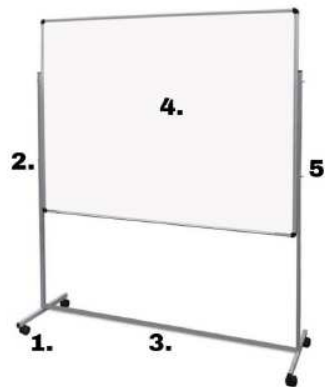
**Estructura para Pizarra
móvil magnética**

- 1. Ruedas**
2. Perfil lateral izquierdo
3. Perfil soporte medio
4. Pizarra magnética
5. Perfil lateral derecho.

- (57) **Resumen:** Tener una pizarra fija en la pared limita a trabajar solo dentro de esa zona. Impidiendo moverla a otro sitio ya que se tendría que desatornillar, desmontar y llevarla hasta el otro lugar deseado. Con la estructura de pizarra móvil propuesta existe la facilidad de poder desplazarla de un lugar a otro sin necesidad de mucho esfuerzo gracias a sus 4 ruedas con frenos y poder colocarla en un lugar determinado. Ofreciendo más comodidad al dar una clase, conferencia, reunión o anotaciones de estudio o trabajo. Su armado es fácil, y se puede desmontar y llevar a todos lados.

(19) Dirección Nacional de la Propiedad Industrial – URUGUAY**(12) Modelo de Utilidad****(11) UY u/004854**

- (51) **Clasificación Internacional:** D 05C 17/00(2006.01)
(22) **Fecha de presentación:** 26/09/2022
(30) **Datos de prioridad:**
(71) **Solicitante:** Lucia Cebreiros [UY]
(72) **Inventor:** Lucia Cebreiros Cosenza [UY]
(74) **Agente/apoderado:** Lucia Cebreiros ()
(54) **Título:** Aguja de Bordado a mano para la técnica punchneedle o aguja punzón.

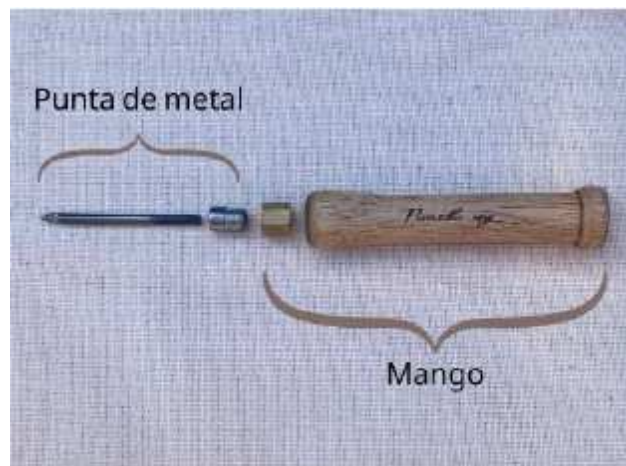

- (57) **Resumen:** La aguja Punch uy para bordado manual punchneedle o también llamada aguja punzón, como lo indica su traducción al español, consta de cuatro puntas de metal de distintos calibres con rosca intercambiable a un único mango de madera, por lo tanto, con un solo mango contamos con cuatro tamaños de aguja para colocar distintos tipos de hilados ofreciendo crear distintos relieves, calibres y formas de bordado. El diseño de esta aguja de bordado le brindada agilidad, practicidad y funcionalidad a la técnica punchneedle de bordado manual.

(19) Dirección Nacional de la Propiedad Industrial – URUGUAY**(12) Modelo de Utilidad****(11) UY u/004855**

- (51) Clasificación Internacional: F 16M 11/04(2006.01)
(22) Fecha de presentación: 26/09/2022
(30) Datos de prioridad:
(71) Solicitante: romer santiago [VE]
(72) Inventor: Romer Jeffrey Santiago Camacho [VE]
(74) Agente/apoderado: romer santiago ()
(54) Título: Soporte trípode para notebook

Soporte trípode para Notebook

- 1. Trípode**
2. Bandeja
3. Sistema de regulación
4. Borde elevado de protección

- (57) **Resumen:** Para estudiar o trabajar se necesita por lo general una mesa para colocar la notebook, la cual no siempre tiene la altura óptima y abarca espacio. Muchas personas que trabajan largas jornadas podrían adoptar posiciones que causen dolor de espalda y cuello. Con el soporte de notebook propuesto se ahorra espacio, es la solución ideal, ya que puede regular la altura, grado de inclinación y es portátil, se puede llevar a todos lados. Este soporte está diseñado para sostener laptops desde 11 a 17 pulgadas sin ningún inconveniente y de manera segura, ayudando a mejorar tu postura y comodidad.

ÍNDICE POR TITULARES DE MARCAS

Titular	N° Exp	Marca
A.A. DE ALMEIDA EQUIPAMENTOS AGROINDUSTRIAL LTDA.	542745	ALMEIDA EQUIPAMENTOS
ABEMOL S.A.	542178	POWER LIFE R (mixta)
ABITAB S.A.	542188	BILETERA ABITAB (mixta)
ABZARADEL ROITMAN RAFAEL	542073	MASTERDENT (mixta)
Ace Rent A Car Reservations, Inc.	541897	ACE RENT A CAR (mixta)
Ace Rent A Car Reservations, Inc.	541898	ACE RENT A CAR
ACUARELA S.R.L.	542368	MIX PINTURERÍAS (mixta)
Ademar Firpo	541929	LORENZO
AGAM LTDA.	542325	ANTALGIA
AGAM LTDA.	541298	VARI-RELAX
AGL ELETRONICOS DO BRASIL S/A	542809	AGL SOLUÇÕES EM SEGURANÇA ELETRÔNICA (mixta)
Alcamp S.A.	542170	CUMMOTORS
ALCEC HERMANOS SRL	541924	EGAN
ALCEC HERMANOS SRL	541986	(figurativa)
ALCEC HERMANOS SRL	541985	EGAN (mixta)
Alejandro Cardozo	542661	COMUNIDAD CONSCIENTE
ALIAN S.A.	540882	AMIGOS PUNTA CARRETAS (mixta)
ALIAN S.A.	540883	AMIGOS PUNTA CARRETAS (mixta)
ALICORP S.A.A	542724	PELU QUERIDA
ALICORP S.A.A	542744	MAGIA ANDINA
ALICORP S.A.A	542739	MAGIA ANDINA
ALICORP S.A.A	542738	DIOSA RULOSA
ALICORP S.A.A	542737	FRESCURA QUE DURA
ALICORP S.A.A	542742	DIOSA RULOSA
ALICORP S.A.A	542726	WOWMOM (mixta)
ALICORP S.A.A	542727	PELU QUERIDA
ALICORP S.A.A	542729	WOWMOM (mixta)
ALICORP S.A.A	542730	REPARACIÓN DIVINA
ALICORP S.A.A	542731	AMARÁS (mixta)
ALICORP S.A.A	542732	REPARACIÓN DIVINA
ALICORP S.A.A	542733	AMARÁS (mixta)
ALICORP S.A.A	542734	BENDITO CLIMA DE LIMA
ALICORP S.A.A	542736	BENDITO CLIMA DE LIMA
ALICORP S.A.A	542735	FRESCURA QUE DURA
Allergan Holdings France SAS	542568	SKINVIVE BY JUVÉDERM (mixta)
Allergan Holdings France SAS	542564	SKINVIVE
ALU TRADE SRL	541962	ALMA GOURMET (mixta)
AMBERPLAN S.A.	542603	SAK (mixta)
ANA GRACIELA CIARLO PEREZ	542211	COTIZAHOY (mixta)
Miguel Gentile y Andrea Liotti	541727	GENTILE EXÓTICOS (mixta)
ANDRES GALLO DUBOURG	542349	SUPERMERCADOS U UNIDOS POR VOS (mixta)
Andrés Piriz	542760	HI DISNEY! (mixta)
ANTONIO BASSO & FILHOS LTDA	542845	QUINTA VINHA (mixta)
APLAZ S.A DE C.V.	541492	APLAZO
APPLE INC.	542268	DYNAMIC ISLAND
APPLE INC.	542269	A16 BIONIC

Titular	N° Exp	Marca
Apple Inc.	542749	APPLE WATCH ULTRA
ARASHI VISION INC.	542484	INSTA360 (mixta)
ARMET S.A.	542023	CEPA MOBILITY (mixta)
ASOCIACION TURISTICA DE MONTEVIDEO	519686	MONTEVIDEO PASS
ASTEROL S.A.	543072	SOUTH AMERICA INCOMING
Astier de Villatte	543059	ASTIER DE VILLATTE
Astori Estructuras S.A.	542372	PICAST (mixta)
ATRIM ARGENTINA S.A.	542623	ATRIM REALZA TUS AMBIENTES (mixta)
Augmented Reality Concepts, Inc.	541506	EXCEPTIONALLY ENGAGING EXPERIENCES
Augmented Reality Concepts, Inc.	542396	IMPEL
AUTECO MOBILITY S.A.S.	542699	STARK (mixta)
Aviva Brands Limited	541716	AVIVA INVESTORS
BAINEPES SA	542608	GRAN FAMILIA (mixta)
BANCO BILBAO VIZCAYA ARGENTARIA, S.A.	543067	BQIS
BANCO DE LA REPÚBLICA ORIENTAL DEL URUGUAY	543049	MIBROU (mixta)
Baudilio Eusebio Belo Calabia	542118	TODO ES MILONGA
Bausch & Lomb Incorporated	541945	BAUSCH + LOMB ULTRA
Bayer Aktiengesellschaft	542157	CAL.AI
BAYERISCHE MOTOREN WERKE AKTIENGESELLSCHAFT	542172	BMW ALPINA
Bernardo Ferreira	542408	TSUNAMI FREE
BETO CARRERO GESTÃO DE MARCAS LTDA	542464	BETO CARRERO BETO CARRERO WORLD (mixta)
BETO CARRERO GESTÃO DE MARCAS LTDA	542466	BETO CARRERO BETO CARRERO WORLD (mixta)
BETO CARRERO GESTÃO DE MARCAS LTDA	542471	BETO CARRERO BETO CARRERO WORLD (mixta)
BETO CARRERO GESTÃO DE MARCAS LTDA	542472	BETO CARRERO BETO CARRERO WORLD (mixta)
BETO CARRERO GESTÃO DE MARCAS LTDA	542474	BETO CARRERO WORLD
BETO CARRERO GESTÃO DE MARCAS LTDA	542477	BETO CARRERO WORLD
BETO CARRERO GESTÃO DE MARCAS LTDA	542478	BETO CARRERO WORLD
BETO CARRERO GESTÃO DE MARCAS LTDA	542479	BETO CARRERO WORLD
BETO CARRERO GESTÃO DE MARCAS LTDA	542481	BETO CARRERO WORLD
BETO CARRERO GESTÃO DE MARCAS LTDA	542468	BETO CARRERO BETO CARRERO WORLD (mixta)
BIAGRO COMERCIO E DISTRIBUICAO DE INSUMOS AGROPECUARIOS LTDA.	542855	BIAGRO (mixta)
BIOMA INDUSTRIA COMERCIO E DISTRIBUICAO-EIRELI	542850	BIOMA (mixta)
Blackstone TM L.L.C.	541990	BLACKSTONE
BLUM SA	542310	JB HOME & OFFICE (mixta)
BODEGAS Y VIÑEDOS NICOLAS CATENA S.A.	542648	CATENA ZAPATA HILL OF BONES

Titular	N° Exp	Marca
BORED OXENS S.A.	542015	OXEN (mixta)
BOYERCO S.A.	542160	DACOSTA (mixta)
Brain Labs Digital Ltd	542136	BRAINLABS
BRANDSTORY, S.L.	542858	PLET (mixta)
BRISANIER S.A.	543047	TRATO BY RAPPI (mixta)
Brum Costa Abogados S.A.S.	543030	BRUM COSTA ABOGADOS (mixta)
Brum Costa Abogados S.A.S.	542925	BRUM COSTA
BRUNA RUELA TAVARES ME	542195	BRUNA TAVARES
Bruno Rivero	542690	TENET (mixta)
BYD COMPANY LIMITED	542226	TANG
BYD COMPANY LIMITED	542231	SONG
BYD COMPANY LIMITED	542230	QIN
BYD COMPANY LIMITED	542228	D1
BYD COMPANY LIMITED	542229	HAN
BYD COMPANY LIMITED	542227	YUAN
BYD Company Limited	542509	(figurativa)
BYRNA TECHNOLOGIES INC.	542274	BYRNA
BYRNA TECHNOLOGIES INC.	542275	(figurativa)
CACHAY S.A.	541964	ARROYO VERDE (mixta)
CACHAY S.A.	541965	ARROYO VERDE ACOMPAÑA TU DIA (mixta)
CACHAY S.A.	541967	ARROYO VERDE ACOMPAÑA TU DIA (mixta)
CACHAY S.A.	541966	ARROYO VERDE ACOMPAÑA TU DIA (mixta)
Cámara Inmobiliaria Punta del Este Maldonado	542817	GOPUNTA.COM.UY (mixta)
CAMILO CUBA	542654	KREDYTZ (mixta)
CAMILO CUBA	542363	KLIN! (mixta)
Caram, María Inés	542619	ÉPOCA BELLA (mixta)
CARBAJALES, ALFONSO	542812	PANORAMA
Carlos Alvarez	542815	MOVIMIENTO ESPIRITA (mixta)
Carolina Cruzat	542827	MALVA
Carolina Hernandez	524409	TAROT AKASHICO URUGUAY
CAROLINA PEREZ OSPITAL	541364	TREE HOUSE DECO (mixta)
Carpintería Metálica Orlando	542923	ORLANDO (mixta)
CASA PIRQUE S.A.	542014	NAVIERO
CASA PIRQUE S.A.	542013	ANACUARA
Cash S.A.	542797	CASH FEST (mixta)
Catbe S.R.L.	542554	TOPAZ HOME (mixta)
Cecilia Peri	542905	LA ADORADA (mixta)
CENTRO CEIBAL PARA EL APOYO A LA EDUCACION DE LA NIÑEZ Y LA ADOLESCENCIA	542492	EDUX CEIBAL (mixta)
CENTRO DE ENTRENAMIENTO DE CABALLOS DEPORTIVOS (CE.CA.DE) ASOCIACION CIVIL	542167	CECADE (mixta)
CESIM CO JUPITER S.A.	542544	MELL'S (mixta)
CIMA, FEDERICO	542869	CANNECT INDOOR FUTURE (mixta)
Citizen Watch Company of America, Inc. d/b/a Bulova	542796	BULOVA OCULUS
Clarios Energy Solutions Brasil Ltda.	542112	DUREX
Clarios Energy Solutions Brasil Ltda.	542168	X DUREX (mixta)
Clarios Technology and Recycling GmbH	541952	(figurativa)
Claris International Inc.	542798	CLARIS WEBDIRECT
Claris International Inc.	542696	CLARIS STUDIO

Titular	N° Exp	Marca
Clarís International Inc.	542802	CLARIS CONNECT
Clarís International Inc.	542801	CLARIS SERVER
Clarís International Inc.	542799	CLARIS GO
Clarís International Inc.	542719	CLARIS PRO
Clark Foods, Inc.	542401	REÁL INFUSED EXOTICS
CLAUDIA ADORNO SAS	541869	CLAUDIA ADORNO
CODERE NEWCO, S.A.U.	542460	C (mixta)
CODERE NEWCO, S.A.U.	542445	C (mixta)
COLGATE-PALMOLIVE COMPANY	542831	LADY SPEED STICK DOUBLE DEFENSE BY MENNEN (mixta)
COLGATE-PALMOLIVE COMPANY	542829	LADY SPEED STICK DOUBLE DEFENSE BY MENNEN (mixta)
COLGATE-PALMOLIVE COMPANY	542826	LADY SPEED STICK DOUBLE DEFENSE BY MENNEN (mixta)
Compañía Uruguaya de Transportes Colectivos Sociedad Anónima (C.U.T.C.S.A.)	542667	¿CÓMO ME CUIDO EN EL TRÁNSITO? CUTCSA (mixta)
Compañía Uruguaya de Transportes Colectivos Sociedad Anónima (C.U.T.C.S.A.)	542668	INVOLUCRARSE CUTCSA (mixta)
COPIZ PAEZ, NOELIA	542547	VIA STUDIO
COPIZ PAEZ, NOELIA	542549	COOL DOG
CYTEC TECHNOLOGY CORP.	542995	AEROSOL
CZ Vaccines, S.A.U.	542853	ZENDAL (mixta)
DANI CONDUCTORES ELECTRICOS LTDA.	542296	DNI (mixta)
Daniel Antonio Pietrobon	542697	PIETCARD (mixta)
Horacio Garagiola; Diego Martin Herrera y Daniel Weiman	541926	ENERGÍA DEL FUTURO URUGUAY (mixta)
Danzelay SA	542618	EL DESEMBARCO (mixta)
Daramix S.A.	541927	MY GLOBAL ASSIST ASISTENCIA EN VIAJES (mixta)
DELIBRA S.A.	542340	ROSEDEZ
DELIBRA S.A.	541799	EMPIRIA
DELIDIPS SAS	542019	KYROS (mixta)
DIEGO GASTÓN GONZALEZ GONZALEZ	541841	DIEGODELACURVA
Diego Hernan Perez Roca	542559	ONE STORAGE (mixta)
DOMINGO R. GHELFA	542819	GROW CREADO POR LA NATURALEZA (mixta)
Dufry International AG (Dufry International SA) (Dufry International Ltd)	542775	LOTE OCULTO (mixta)
Durman Esquivel S.A.	542357	FLEXFLOW (mixta)
DXMAX BRASIL LTDA	542814	DXMAX (mixta)
EGA Onshore Investments LLC	542399	MINIMAL (mixta)
EGA Onshore Investments LLC	542392	CELESTIAL (mixta)
EL HOGAR DE LAS MEDIAS S.A.	541743	COMFIT LÌNEA ATHLEISURE 2022 (mixta)
ELDINAR S.A.	542367	TODOACA BEAUTY (mixta)
ELECTROQUIMICA S.A.	542125	DINORA
JAVIER ALEJANDRO DUARTE LÓPEZ y EMILIO RAFAEL NICOLA BATISTA	542926	UNIMATE RPA (mixta)
EQUIPO S.A.	541784	TEM (mixta)
EQUIPO S.A.	541785	TEM (mixta)
EQUIPO S.A.	541782	TEM (mixta)
EQUIPO S.A.	541781	TEM (mixta)
EQUIPO S.A.	541778	TEM (mixta)
EQUIPO S.A.	541776	TEM (mixta)

Titular	N° Exp	Marca
EQUIPO S.A.	541775	TEM (mixta)
EQUIPO S.A.	541774	TEM (mixta)
EQUIPO S.A.	541783	TEM (mixta)
EQUIPO S.A.	541773	TEM (mixta)
Ernesto Rodrigo DAVIDSOHN BENET	542572	RONDPOINT
ESPÓSITO, MARIANA	542117	LALI (mixta)
Essity Hygiene and Health Aktiebolag	542182	TRITECH PERFORMANCE (mixta)
ESTANCIA SANTA MANUELA S.A.	542825	ANDALUZ
ESTEVE PHARMACEUTICALS, S. A.	541085	SEGLENTIS
ESTEVE PHARMACEUTICALS, S. A.	541084	VELYNTRA
EUROFARMA URUGUAY S.A.	542138	LÉPTICO
EUROPEAN COSMETICS LIMITADA	541978	MIAMI SECRET´S (mixta)
EUROPEAN COSMETICS LIMITADA	542764	IPANEMA (mixta)
EVC INDUSTRIAL LTDA	541081	VONIXX
Exxon Mobil Corporation	542692	MOBIL DELVAC LEGEND (mixta)
facundo solveyra	542806	SANTORINI (mixta)
FAMINTER S.A.	542280	M MONTEVIAL (mixta)
FAMINTER S.A.	542273	GINO-PARCHE
Farm Fresh L.L.C	542635	SAPORA (mixta)
FCA US LLC	542681	(figurativa)
FEDERICO M. RODRÍGUEZ DOS SANTOS S.A.S. SOCIEDAD POR ACCIONES SIMPLIFICADA	541812	#MODOTORO (mixta)
Federico Urquiola	542621	BLACK SHEEP (mixta)
FERNÁNDEZ GARAYALDE, NESTOR MARTÍN	542410	MR MAGIC RIVER (mixta)
FILLERS SAS	542557	PRANO MEDICINA ESTÉTICA (mixta)
FINCA 1948 S.A.	542212	BODEGA URQO PALO SANTO
FLO MAGAZACILIK VE PAZARLAMA ANONIM SIRKETI	542374	X KINETIX (mixta)
FLO MAGAZACILIK VE PAZARLAMA ANONIM SIRKETI	542400	LUMBERJACK (mixta)
Florencia Fischetti	542761	FLORALIA
Florencia Sica	542774	NARCISA (mixta)
FMC Agro Singapore Pte Ltd.	542315	HERO
FORTER S.A.	542143	POLANCO (mixta)
FORTYLEX S.A.	542908	ELITE (mixta)
FRANCO GUSTAVO SILVEIRA ZAMORA	542215	HOGARUP
FRAU LANGDON, DIEGO BARTOLOME	541847	FRAU COMERCIO EXTERIOR (mixta)
Gabriel Mendez	542577	MENDEZ IP
Pellistri Rebollo, Facundo y Garcia Azzolini, Camila Belen	542647	BULSKINO (mixta)
GARCIA LOPEZ NATALIA	541912	TIMBÓ
GARCÍA PICCIOLI, PAOLA XIMENA	542261	YAESTÁ
GARRIDO FIALHIO MICAELA EDELWEISS Y CASTILLO OYARZABAL MARIANA SOCIEDAD DE HECHO	542365	APEGO ESPACIO ACUATICO INFANTIL (mixta)
General Motors LLC	542059	MULTIBOARD
GENTILAR SAS	541814	LAND REAL ESTATE SOLUTIONS (mixta)
Jorge Martin Gelezoglo Cazzuli y Geronimo Lisboa	543031	VERANO BANANA PREMIUM (mixta)
GIORGIO ARMANI S.P.A.	541968	GIORGIO ARMANI SÌ (mixta)

Titular	N° Exp	Marca
GO EXPER PARTICIPACOES LTDA.	542851	GOEXPER (mixta)
GOCCO CONFEC S.A.	542498	GOCCO (mixta)
GONZALEZ GROSSI, LUIS FERNANDO	542879	FARO GRUPO INMOBILIARIO (mixta)
PEREZ PARONI, SANTIAGO y GONZALEZ MONTANER, MAGIN	541737	MANKI (mixta)
GONZALO ADRIAN PACHECO GASTESI	542591	PLANIFY (mixta)
GONZALO ADRIAN PACHECO GASTESI	542592	PLANNER (mixta)
GONZALO ADRIAN PACHECO GASTESI	542593	PLANIFY (mixta)
GONZALO ADRIAN PACHECO GASTESI	542594	PLANNER (mixta)
Gonzalo Diez	542290	TIWAZ TRAIL & FITNESS STORE (mixta)
GREISING Y ELIZARZU SRL	541905	CEBADAS CARDINAL (mixta)
Grupo Bongiovanni S.A.	542436	MATUTE (mixta)
Grupo Bongiovanni S.A.	542435	NUTRIBON (mixta)
H. KRULL & C. S.P.A.	542180	ACCA KAPPA DAL 1869 (mixta)
HENDERSON & CIA. S.A.	542842	\$ TIENDA VALES TUS COMPRAS TE DEVULEVEN DINERO (mixta)
HENDERSON & CIA. S.A.	542839	\$ TIENDA VALES (mixta)
HENDERSON & CIA. S.A.	542841	\$ TIENDA VALES TUS COMPRAS TE DEVULEVEN DINERO (mixta)
HENDERSON & CIA. S.A.	542838	\$ TIENDA VALES (mixta)
Hexagon Group Ltd	541807	HEXAGON GROUP
Hexagon Group Ltd	541811	HEXAGON GROUP (mixta)
Hexagon Trading AG	541804	HEXAGON TRADING
Hexagon Trading AG	541806	HEXAGON TRADING (mixta)
Horacio Miguel FRACCIONE	541937	ACQUA
HRU S.A.	542053	MARONAS (mixta)
Hugo Javier Fagundez Suarez	542238	BUENA VIDA GYM (mixta)
Inbicon A/S	542300	ORSTED (mixta)
Inbicon A/S	542299	ORSTED (mixta)
Inbicon A/S	542298	ORSTED (mixta)
Inbicon A/S	542295	ORSTED
INDISOR S.A.	541865	BIG MUSIC
INDRAMERICA SAS	542601	LMK TM GLOBAL ENGLISH CENTRE BETTER ENGLISH.BETTER OPPORTUNITIES (mixta)
INDUNET S.A.	542122	MASBURGUER (mixta)
INFINIA S.A.S	542412	INFINIA (mixta)
Instituto Pasteur de Cosmiatria Ltda.	542047	678 BRAZIL (mixta)
Intel Corporation	542832	INTEL BLOCKSCALE
Intel Corporation	542638	INTEL GETI
INTENDENCIA DE MONTEVIDEO	541179	MVD NOTICIAS MVD NOTICIAS (mixta)
INTENDENCIA DE MONTEVIDEO	541180	MVD NOTICIAS MVD NOTICIAS (mixta)
INTERNATIONAL TAEKWON-DO FEDERATION-ITF	541960	ITF INTERNATIONAL TAEKWON-DO FEDERATION (mixta)
INTRASOFTWARE S.R.L.	541495	N NETVIAX (mixta)
IPSEN PHARMA S.A.S.	542002	EVOSOM
IPSEN PHARMA S.A.S.	542001	SETSOMA
Isaura S.A.	542028	ISAURA (mixta)
Isis Boetto	542430	ÁMBAR COSMÉTICA NATURAL (mixta)
IXALAB S.A.S.	541520	TRACE SURFER (mixta)
Jaime Tobal	542757	VAN HALEN
JIANGSU DONGCHENG POWER TOOLS CO., LTD.	542291	DCK (mixta)

Titular	N° Exp	Marca
JIANGSU DONGCHENG POWER TOOLS CO., LTD.	542292	DONG CHENG (mixta)
JIANGSU DONGCHENG POWER TOOLS CO., LTD.	542294	DCA (mixta)
Jiangsu Tellus Power Co., Ltd.	542017	TELLUS POWER (mixta)
JIMENA MAZZONE ARTAGAVEYTIA	542039	CAMINITO (mixta)
JingAo Solar Co., Ltd	542856	JA SOLAR (mixta)
Joaquin Forrasi	541875	URUTHYST
JOHNSON & JOHNSON	542536	ENSEAL
Johnson & Johnson	542982	K KENVUE (mixta)
Johnson & Johnson	542981	KENVUE
Jorge Castillo	541938	EXPAT SERVICES URUGUAY (mixta)
Jose Francisco Arriada cedrez	541991	PIZZA VA!
Jose Ignacio Lazaro Salmini	542476	EUROLMOBILE (mixta)
JOSE LUIS GOMEZ	542942	METALBULL HERRAMIENTAS (mixta)
CONSULTORES Y ADMINISTRADORES DE EMPRESAS S.R.L. y J.P.D. ASOCIADOS S.A.	542449	KRESTON GLOBAL (mixta)
Juan Balbuena	542309	LIPIN S.A. CONSTRUCCIÓN VIAL (mixta)
JUAN CARLOS LABARERE	541894	SPORTADE
JUAN DOMINGO LEIVA	542904	LEIVA (mixta)
JUAN DOMINGO LEIVA	542903	LEIVA (mixta)
JUAN DOMINGO LEIVA	542906	LEIVA (mixta)
Kimberly-Clark Worldwide, Inc.	542569	HUGGIES ECO PROTECT
KOMATSU LTD.	542338	KOMATSU (mixta)
KSM REALTY ADMINISTRAÇÃO E PARTICIPAÇÃO LTDA	542413	BEYOND THE CLUB
LA BUENA ESTRELLA S.A.	542232	BIO TICKXAN
LA BUENA ESTRELLA S.A.	542235	BIOXAN
LA BUENA ESTRELLA S.A.	542234	TICXAN
LA BUENA ESTRELLA S.A.	542233	TICKXAN
LABOCAY S.R.L.	541583	ITSANI PLASMA MARINO
LABORATORIO GADOR S.A.	541956	MIRAFEL
LABORATORIO GADOR S.A.	541954	MIRAGRON
LABORATORIO GADOR S.A.	542513	NUSINEREN
LABORATORIO GADOR S.A.	541955	MYRGON
LABORATORIOS FERRINI S.A.I.C.I	542037	ZONO
LATTY INTERNATIONAL S.A.	542700	LATTY (mixta)
LATTY INTERNATIONAL S.A.	542765	LATTY (mixta)
Lemontech SpA	541417	CASETRACKING
Lemontech SpA	541416	TIMEBILLING
LENADY S.A.	542747	(figurativa)
LENADY S.A.	542746	POMELO GO FINTECH (mixta)
LEONARDO FRANCIA	541876	INKSIDE
LEVI STRAUSS & CO.	542071	DOCKERS
LEVI STRAUSS & CO.	542072	(figurativa)
Linde GmbH	543058	LINDE (mixta)
LINEAGE LOGISTICS HOLDINGS, LLC.	542033	LINOS
LONEMAR S.A.	542434	THE YACHT LUXURY RESIDENCES (mixta)
L'OREAL	542607	RÉNERGIE H.P.N. 300-PEPTIDE CREAM (mixta)
LOUIS DREYFUS TRADEMARKS B.V.	541543	LDC. LOUIS DREYFUS COMPANY (mixta)
LOUIS DREYFUS TRADEMARKS B.V.	541542	LOUIS DREYFUS

Titular	N° Exp	Marca
Lubrifiilm Group SAS	542893	LUBRIFILM
Lucia Moran	542130	NOQUESO
Lucia Moran	542121	EL CLUB DEL QUESO
LUCIENNE VAN HOFF	542558	MURAPOL
LUIS ALBERTO GONZALEZ PINTOS	542808	CASA ALONSO
LUIS MARCELO VECINO	542075	LM LUIS MARCELO VECINO (mixta)
LUMINOVA PHARMA CORPORATION GmbH	542355	ZOBUL
LUMINOVA PHARMA CORPORATION GmbH	542190	UF UNIFEMME BIENESTAR QUE VA CONTIGO (mixta)
LUMINOVA PHARMA CORPORATION GmbH	542352	BENSIBEN
LUMINOVA PHARMA CORPORATION GmbH	542043	UNIFEMME
LUMINOVA PHARMA CORPORATION GmbH	542353	MAXTAR
LUMINOVA PHARMA CORPORATION GmbH	542354	VEKPROFEN
LUMINOVA PHARMA CORPORATION GmbH	542042	UF UNIFEMME (mixta)
Luveck Medical Corp.	541368	LUVECK ...ES VIDA (mixta)
LUZERNE BRANDS LIMITED	542634	DARNEL BIO (mixta)
LUZERNE BRANDS LIMITED	542680	DARNEL REDUZ (mixta)
MABLE S.A.	542132	CARE UP (mixta)
Magdalena Migliavacca	542262	CLÍNICA ESTÉTICA CAPILAR (mixta)
MALAN AGUIRRE ANALIA, PRILASSNIG CUNHA MARIA INES Y OTROS SOCIEDAD DE HECHO	542297	ANMA CONSULTORES & AUDITORES (mixta)
MARCELO TOCCHETTO	542600	TOCHE
MARCIRY S.A	542584	WORLD FINANCIAL CENTER MONTEVIDEO
Marco Financiam SAS	542441	MARCO (mixta)
María Belén Mundemurra Archs	542538	RADIANTE EXPERIENCIAS EN JUEGO
María Belén Rocha Dive	542054	KITCHEN SPONGE
María Belén Rocha Dive	542055	FREECO
MARIA SILVIA MATO GARCIA	542785	ALISMA (mixta)
María Victoria Pereira Flores	542092	CAMINA CINE AMBIENTAL MONTEVIDEO (mixta)
Martin Larrosa Sequeira	542830	JACKYS ROSAS (mixta)
Mat Product & Technology, S.L.	542016	TWIINS CONNECTED IN MOVEMENT (mixta)
Mateo Miraglia	542992	ARRABAL (mixta)
MEGA LABS S.A.	542579	METROZOL
MEGA LABS S.A.	541950	MOSAPRINA
MEGAAGRO URUGUAY S.A.	542426	M MEGAAGRO EXCELENCIA AL SERVICIO DE SU NEGOCIO (mixta)
Mercedes-Benz Group AG	542223	AMG (mixta)
MICHELENA MASSIOTTI, CAROLINA	543065	EVALUNA
Midea Group Co., Ltd.	542880	MDV (mixta)
Mint Condition S.A.S.	542203	MINT (mixta)
MIPAC SRL	542224	HYDRATE (mixta)
MIRA, ESTEBAN PABLO	542411	RÖK (mixta)
MO & PC COLLECTIONS URUGUAY SRL	542852	MO & PC URUGUAY (mixta)
MOLINOS DEL ATLANTICO S.A.S.	542364	LA NIEVE (mixta)

Titular	N° Exp	Marca
Monster Energy Company	542120	PREDATOR
Monster Energy Company	542633	JAVA MONSTER
MYROSUR S.A.	542283	IDEAL (mixta)
NEIRA MONTEMURRO, HÉCTOR	542645	RISTORANTE
Nintendo of America Inc.	542691	(figurativa)
Nomis LLC	542318	MILESCRAFT
Novus Importaciones SRL	541374	TERSUS RENEWABLE ENERGY (mixta)
Nub Technologies Ltd	542425	NUB
NUEVAVISION UY S.A.S	541976	NUEVA VISIÓN (mixta)
NV Bekaert SA	542086	B (mixta)
OLARTE FERNANDEZ JULIA LAURA	541823	CUATRO DE JULIA (mixta)
OLARTE FERNANDEZ JULIA LAURA	541819	CUATRO DE JULIA (mixta)
OLARTE FERNANDEZ JULIA LAURA	541816	CUATRO DE JULIA (mixta)
OLARTE FERNANDEZ JULIA LAURA	541826	CUATRO DE JULIA (mixta)
ÖNTAR TARIM ALETLERI SANAYI VE TICARET LIMITED SIRKETI	542213	ÖNTAR (mixta)
OPIA SAS	542251	RIO AZUL SANEAMIENTO SOSTENIBLE (mixta)
OPIA SAS	542248	RIO AZUL SANEAMIENTO SOSTENIBLE (mixta)
OPIA SAS	542249	RIO AZUL SANEAMIENTO SOSTENIBLE (mixta)
OPIA SAS	542250	RIO AZUL SANEAMIENTO SOSTENIBLE (mixta)
OPRUMIN S.A.	542483	VITAL QUICK (mixta)
Organización Internacional Agropecuaria S.A	542491	OIA ORGANIZACIÓN INTERNACIONAL AGROPECUARIA CERTIFICAMOS CONFIANZA Y CALIDAD (mixta)
OTADELER S.R.L.	542089	REPÚBLICA ROTISERÍA (mixta)
PABLO ARTIGAS	542214	DÍA DE LA PAZ / SEMANA DE LA PAZ
Pablo Malian	540985	NITROL (mixta)
PAGINAS AMARILLAS S.A.S.	542921	PAGINAS CLASIFICADAS
PAGINAS AMARILLAS S.A.S.	542919	ENCUENTRE YA
Panificadora Bimbo del Uruguay S.A.	542967	RICARDITO CELESTE (mixta)
Panificadora Bimbo del Uruguay S.A.	543025	CHOCOWAFFLE (mixta)
Pasaco S.A.	542490	YF
PASTICHE SAS	541973	(figurativa)
PASTICHE SAS	541972	PASTICHE (mixta)
Patricia Antonia Rennis Gómez	542317	NACHOS DE ALGAS (mixta)
PEÑAFLO R VIQUE ROMINA	541923	K KETO FOOD BY MARIA (mixta)
Pilar Abella Echevarne Antia	542596	LA PANETERA MASCOTERA
Pilar Abella Echevarne Antia	542595	DELI FOR PETS
PINTELUX PAINTINGS S.A.	542155	PINTELUX MASTER (mixta)
PINTELUX PAINTINGS S.A.	542156	PINTOR (mixta)
PINTELUX PAINTINGS S.A.	542144	PINTELUX (mixta)
PIZZA DATA INTERNATIONAL, LLC.	542184	DATA (mixta)
POMAR S.R.L.	542101	POMAR
POMAR S.R.L.	542102	LIBERO
PREMEZCLAS ENERGETICAS PECUARIAS S.A. DE C.V.	542062	LIPO FEED (mixta)
Prestadores de Servicios de Colima, S.A de C.V.	541042	SAFE (mixta)
Prestadores de Servicios de Colima, S.A de C.V.	541041	FRIENDLY (mixta)
Prestadores de Servicios de Colima, S.A de C.V.	541040	ANCLA R (mixta)

Titular	N° Exp	Marca
Prestadores de Servicios de Colima, S.A de C.V.	541039	TUNY R (mixta)
Prestadores de Servicios de Colima, S.A de C.V.	541043	GRUPOMAR R (mixta)
Productora y Comercializadora Odontológica New Stetic S.A.	542952	ZAFIRA LIGHT CURING COMPOSITE
PTC Therapeutics International Limited	542022	TEGSEDI
PURATOS N.V.	542194	PASSIONATA
Raúl Calaña	542494	GATO TUERTO (mixta)
Reamerica Reinsurance Managers corredor de reaseguros S.A.	542024	REAMERICA RISK ADVISORS (mixta)
REINALDO DE LUCCA GALERATO	542105	DE LUCCA (mixta)
REINALDO DE LUCCA GALERATO	542107	R. DE LUCCA VINO DE EL COLORADO (mixta)
REINALDO DE LUCCA GALERATO	542103	CRESTA ROJA
REINALDO DE LUCCA GALERATO	542104	COSECHA NOBLE
Ridella`s group Sas	542341	RIDELLA PROPIEDADES (mixta)
RMA ARQUITECTURA LTDA	542529	RMA RAVECCA MONTAÑO ARTAGAVEYTIA ARQUITECTURA (mixta)
Robert Correa	542943	CPE CENTRO POLITÉCNICO DE ESTUDIOS (mixta)
RODRIGUEZ LEHMANN, MARTIN	541859	DF DISTRITO FEDERAL (mixta)
RODRIGUEZ LEHMANN, MARTIN	541951	DAMONJAG
RODRIGUEZ VAGHI JAVIER	542246	SWING RECORDS PRODUCCIONES (mixta)
Rootstrap Holdings, Inc.	540964	ROOTSTRAP
Rootstrap Holdings, Inc.	540965	(figurativa)
ROTUNDAMENTE S.A.S.	542446	HUMANS (mixta)
ROTUNDAMENTE S.A.S.	542422	OTERO
RSI IP Holding, LLC	542740	RUSHBET
RUMPAL COMPANY S.A.	542598	CONEXTIA GPI (GESTIÓN PATRIMONIAL INTEGRAL)
RUMPAL COMPANY S.A.	542597	CONEXTIA
Rural LLC	542555	CLICRURAL (mixta)
SAMSUNG ELECTRONICS CO., LTD.	542611	SAMSUNG INFINITE LINE (mixta)
Samsung Electronics Co., Ltd.	542534	SPACEMAX
SEGUROS SURA S.A.	542265	LOS SOLUCIONADORES (mixta)
SELINA LOYALTY MANAGEMENT LTD.	541741	LUNA NUEVA
SERRAT, ERNESTO	541721	FENIX PACKAGING (mixta)
SGG Lisco LLC	541963	TF (mixta)
SGG Lisco LLC	541961	NEVERFLAT
Shaanxi Fast Gear Co., Ltd.	541970	(figurativa)
Shaida Massud	542049	HOUSING NEGOCIOS INMOBILIARIOS
Sharkoon Technologies GmbH	542578	SHARKOON
Shell Brands International AG	542257	SARAPHALT
SHOWA DENKO K.K.	542794	CHEMISTRY FOR CHANGE
SILVA BARRUTI MARIA EUGENIA Y DE STEFANI MENDILAHRSU ANDRES JUAN SOCIEDAD DE HECHO	541757	NOSELODIGAS
SILVA BARRUTI MARIA EUGENIA Y DE STEFANI MENDILAHRSU ANDRES JUAN SOCIEDAD DE HECHO	541758	NSLD (mixta)
SILVA BARRIOS, MATHIAS LUCIANO y SILVA, WELLINGTON	542417	C1080 CUAREIM 1080 (mixta)

Titular	N° Exp	Marca
SIMBIOSE INDÚSTRIA E COMÉRCIO DE FERTILIZANTES E INSUMOS MICROBIOLÓGICOS LTDA.	542860	STIMUCONTROL (mixta)
SIMBIOSE INDÚSTRIA E COMÉRCIO DE FERTILIZANTES E INSUMOS MICROBIOLÓGICOS LTDA.	542859	FLYCONTROL SIMBIOSE (mixta)
SIMBIOSE INDÚSTRIA E COMÉRCIO DE FERTILIZANTES E INSUMOS MICROBIOLÓGICOS LTDA.	542861	SOLUBPHOS (mixta)
SIMBIOSE INDÚSTRIA E COMÉRCIO DE FERTILIZANTES E INSUMOS MICROBIOLÓGICOS LTDA.	542862	NEMACONTROL (mixta)
SIMBIOSE INDÚSTRIA E COMÉRCIO DE FERTILIZANTES E INSUMOS MICROBIOLÓGICOS LTDA.	542863	SIMBIOSE (mixta)
Sinaptrix SRL	542653	SINAPTRIX (mixta)
SINDICATO MEDICO DEL URUGUAY	542313	SMU SINDICATO MEDICO DEL URUGUAY (mixta)
Société des Produits Nestlé S.A.	542637	OPTI-LAC
Soho Formats LLC	542452	ENAMORÁNDONOS: LA ISLA
Sol María Preube	542018	FRANCA (mixta)
SOL MINERALES Y SERVICIOS S.A.	542185	WHITE CAT
SOLSIRE S.A.	542444	HIP'S (mixta)
SOLSIRE S.A.	542443	HIP'S N'MORE BY PURI (mixta)
SOLSIRE S.A.	542442	PURI RAMITAS VEGGIE (mixta)
SOLSIRE S.A.	542432	PURI SNACKS (mixta)
SOLSIRE S.A.	542438	PURI POPCORN POP (mixta)
SOMOS FLORA SAS	541389	FLORA (mixta)
SOREMARTEC S.A.	542308	FULFIL
SOUTHDEVELOPMENTS S.A.S	542330	BOOSTMONT
Specialized Bicycle Components, Inc.	542344	MEEPER
SRAM, LLC	542174	SRAM
STAGNARI MOISE, HECTOR MARIANO	542643	PURA SANGRE
Strategic Reinsurance Consulting S.A.	541971	THB THB URUGUAY REINSURANCE BROKER (mixta)
SUMITOMO CHEMICAL ARGENTINA S.A.	542518	ZETHAMAXX
SUMITOMO CHEMICAL COMPANY, LIMITED	542148	CARVERO
Sunnova Energy Corporation	542506	SUNNOVA
Sura Asset Management S.A.	542629	MYMO (mixta)
SUZANO S.A.	541685	VISTA SUZANO (mixta)
SUZANO S.A.	541684	LIN SUZANO (mixta)
SYNGENTA CROP PROTECTION AG	542898	SUBLINZA
SYNGENTA CROP PROTECTION AG	542675	ENVIVUS
SYNGENTA CROP PROTECTION AG	542677	DERANCE
SYNGENTA CROP PROTECTION AG	542899	ANAPRIA
SYNGENTA CROP PROTECTION AG	542402	NUELLO
SYNGENTA CROP PROTECTION AG	542901	EQIBRE
SYNGENTA CROP PROTECTION AG	542678	ARTRISIA
SYNGENTA CROP PROTECTION AG	542679	VITAFENS
SYNGENTA CROP PROTECTION AG	542900	CONSINIA
TA -TA S.A.	542216	H&G (mixta)

Titular	N° Exp	Marca
TABACOS VENUS INDUSTRIA E COMERCIO LTDA.	542804	BE HAPPY (mixta)
TABACOS VENUS INDUSTRIA E COMERCIO LTDA.	542805	D'ORA (mixta)
Target Brands, Inc.	540697	TARGET (mixta)
TCT MOBILE EUROPE SAS	542186	ONETOUCH
TECHNOS DA AMAZÔNIA INDÚSTRIA E COMÉRCIA S.A.	542169	TECHNOS (mixta)
TECSPAL TECHNOLOGIES SAS	542636	TECSPAL (mixta)
Tenro AG	542263	THE ROGER
THE MEDIAPRO STUDIO S.L.	542252	MOONLYON
The Vanguard Group, Inc.	542580	VANGUARD
THELEATHERTECH S.A.	542356	TRIKE DRIVE ELECTRIC (mixta)
Tianjin Fivalco Industrial Co., Ltd.	542646	F FIVALCO (mixta)
RUMBO ARRUTI, PABLO JAVIER y TORRES, SANDRA	542284	COMPEX
TOSKANI S.L.	542409	TOSKANIMED (mixta)
TOYOTA JIDOSHA KABUSHIKI KAISHA (also trading as TOYOTA MOTOR CORPORATION)	542512	STOUT
TRANSPORTE SELLANES SRL	540037	SELLANES (mixta)
Treck S.A	543075	ABSOLUTE ZERO
Treck S.A	543076	ABSOLUTE FIRE
Treck S.A	543070	TRECK
Treck S.A	543073	ACTIVEX
Treck S.A	543074	VFLEX
Tri-Union Seafoods, LLC	541585	(figurativa)
TVLX Viagens e Turismo S.A.	542795	VIAJANET (mixta)
UBESUR S.A.	542553	MINIMERCADOSU (mixta)
UCROPIT S.A.	541957	UCROP.IT SUSTENTABILIDAD ES + RENTABILIDAD (mixta)
UMBERTO S.R.L.	542866	PRÍNCIPE HUMBERTO (mixta)
Unilever Global IP Limited	542255	ODORONO
UPL Mauritius Limited	542385	(figurativa)
UPL Mauritius Limited	542387	(figurativa)
UPL Mauritius Limited	542388	(figurativa)
UPL Mauritius Limited	542389	(figurativa)
UPL Mauritius Limited	542384	(figurativa)
UPL Mauritius Limited	542383	(figurativa)
UPL Mauritius Limited	542382	(figurativa)
UPL Mauritius Limited	542381	(figurativa)
UPL Mauritius Limited	542386	(figurativa)
URUFARMA S.A.	542741	NOVIDAT
URUFARMA S.A.	542902	PERCICLIB
Valentina Cayota	542676	678 DANZA (mixta)
VANALIM S.A.	542864	SOUL STREET MARKET (mixta)
VARELA HERMANOS, S.A	540802	RON ABUELO AÑEJO (mixta)
VASWER COMPANY S.A.	542165	HAUSER (mixta)
Verisure Sàrl	541987	PRESENSE
VEROPE AG	541512	VEROPE MINING
Versalis S.p.A.	541256	AGON
Versalis S.p.A.	541258	AGON (mixta)

Titular	N° Exp	Marca
VIDIELLA OHOLEGUY, SOFIA	542585	VIDIELLA SOFIA VIDIELLA NEGOCIOS INMOBILIARIOS (mixta)
VIGLIARA S.A.	542881	NIKO COCINA FUSIÓN (mixta)
VILACITY S.A.	542183	IMPROA (mixta)
Visper S.A.	542151	TOGETHER BUSINESS & CONSULTING (mixta)
Vitabiotics Ltd	542777	NEUROMIND
VOKA SAS	541969	VOKA (mixta)
VRIO CORP.	542824	SE VIENE LA QATARSIS (mixta)
VRIO CORP.	542465	PROPÓSITO VRIO. (mixta)
VRIO CORP.	542828	VIVÍ LA QATARSIS (mixta)
Walter Gabriel Chirico Chinelli	541801	PILOTO POR UN DÍA (mixta)
WALTER HUGO S.A.	542259	FUREST (mixta)
WALTER HUGO S.A.	542258	FUREST (mixta)
Walter Urruzola	541904	URUGUAY KYOKUKAIKAN SCHOOL INTERNATIONAL KYOKUSHINKAI ASSOCIATION (mixta)
WUXI PUTIAN IRON CORE CO.,LTD.	542371	PTTX (mixta)
Yiwu Ackiliss Electric Co., Ltd.	542813	RAF (mixta)
YIWU AIDO TRADING CO., LTD.	542847	EZRA (mixta)
ZODIAC INTERNATIONAL CORPORATION	543001	APATRIX (mixta)
ZODIAC INTERNATIONAL CORPORATION	543005	PROCTYL (mixta)
ZODIAC INTERNATIONAL CORPORATION	543007	PANTECTA (mixta)
ZODIAC INTERNATIONAL CORPORATION	542994	TECTA (mixta)
ZODIAC INTERNATIONAL CORPORATION	542997	ALEVIAN DUO (mixta)
ZODIAC INTERNATIONAL CORPORATION	543010	PANTOP (mixta)
ZODIAC INTERNATIONAL CORPORATION	543018	RIOPAN (mixta)
ZV Singapore Pte. Ltd.	541729	ZADIG & VOLTAIRE

ÍNDICE POR TITULARES DE FRASES PUBLICITARIAS

Titular	N° Exp	Marca
COOPERATIVA NACIONAL DE PRODUCTORES DE LECHE (CONAPROLE)	542482	CONAPROLE PRIMERO LO PRIMERO (mixta)
Cronos Climatizaciones SRL .	541683	EXPERTOS EN MÁQUINAS Y HERRAMIENTAS
FA Maringa LTDA	542743	DORMIR BIEN PARA VIVIR MEJOR
FERNELS S.A.	542752	HACELO FÁCIL, HACELO CON EQUUS
FERNELS S.A.	542753	SU BRAZO MÁS FUERTE
MINEVALL S.A.	542237	TU CASA MÁS CÓMODA
MINEVALL S.A.	542181	EXPERTOS EN DESCANSO
PEPSICO, INC.	542822	SIN LAY'S NO HAY PARTIDO
PepsiCo, Inc.	542818	NO LAY'S NO GAME

ÍNDICE

Listado de Códigos Utilizados en el Boletín.....	7
Listado de Agentes de la Propiedad Industrial	11
Solicitudes de Marcas	25
Solicitudes de Frases Publicitarias	207
Resoluciones de Marcas, Concedidas.....	211
Resoluciones de Frases Publicitarias, Concedidas	296
Resoluciones de Marcas, desestimadas	297
Resoluciones de Marcas, desestimadas (Art. 92, D. 34/999).....	301
Resoluciones de Renovaciones, desestimadas (Art. 92, D. 34/999)	301
Resoluciones de Marcas, desistidas (Art. 90, D. 34/999).....	301
Resoluciones de Marcas, desistidas (Art. 92, D. 34/999).....	302
Resoluciones de Marcas, Modificadas.....	303
Resoluciones de Renovaciones, Modificadas	304
Resoluciones de Renovaciones, Anuladas	304
Resoluciones de Renovaciones, Concedidas.....	304
Resoluciones de Renovaciones de Frases Publicitarias, Concedidas	363
Transferencias.....	364
Transferencias desestimadas (Art. 92, D. 34/999)	372
Transferencias de Patentes	372
Cambios de Nombre	373
Cambios de Nombre de Patentes	388
Cambios de Domicilio.....	388
Cambios de Domicilio de Frases Publicitarias	406
Cambios de Domicilio desestimados (Art. 92, D. 34/999)	406
Cambios de Domicilio de Patentes.....	407
Inscripciones de Licencias.....	407
Inscripciones de Licencias de Frases Publicitarias	416
Inscripciones de Prendas.....	416
Modificaciones de Prendas.....	417
Inscripciones de Renuncias Totales.....	418
Inscripciones de Renuncias Parciales.....	418
Resoluciones de Recursos, DNPI	418
Resoluciones de Recursos de Diseños Industriales, DNPI	419
Resoluciones de Reivindicaciones	419
Resoluciones de Patentes, Concedidas	419
Resoluciones de Diseños Industriales, Concedidas	421
Resoluciones de Modelos de Utilidad, Concedidas	421
Resoluciones de Patentes, desestimadas.....	422
Resoluciones de Modelos de Utilidad, desestimadas.....	423
Resoluciones de Patentes, Abandonadas.....	423
Resoluciones de Diseños Industriales, Abandonadas.....	425
Notificaciones de Asesoría.....	426
Notificaciones de Recursos.....	430

Notificaciones de Patentes	431
Solicitudes de Patentes de Invención.....	433
Solicitudes de Diseños Industriales.....	483
Solicitudes de Modelos de Utilidad.....	487
Índice por Titulares de Marcas.....	493
Índice por Titulares de Frases Publicitarias.....	505
Índice.....	507

Depósito legal 325.532
(N° 277)
Impreso en D.N.P.I.
E-mail: administracion.dnpi@miem.gub.uy
Rincón 719 Telefax 2840 1234
C.P. 11.000
Montevideo – Uruguay

Montevideo, 31 de octubre de 2022

Octubre 2022