

N° Exp	Resolución	Marca	Clases	Titular	Ag.
		HURACÁN BUCEO (mixta)	y 25 (Concedida S/D)		
520086	24/10/2022	MOLINO DOLORES (mixta)	31 (Concedida), 30 (Concedida), 29 (Concedida) y 1 (Concedida)	Molino Dolores S.A.	144
520095	28/10/2022	CHORIPANERÍA (mixta)	43 (Concedida)	PELLICER Y DÍAZ S.R.L.	189
520142	07/10/2022	MUJERES IT SOMOS LA COMUNIDAD DE MUJERES EN TECNOLOGIA (mixta)	42 (Concedida S/D)	Lucia Bustamante	
520198	07/10/2022	DIVINA EVA ACCESORIOS JOYAS RELOJES BIJOU	35 (Concedida S/D) y 14 (Concedida S/D)	Cecilia Paratge Debellis	
520242	28/10/2022	SECURITAS	45 (Concedida S/D), 42 (Concedida S/D), 38 (Concedida S/D) y 9 (Concedida S/D)	SECURITAS AB	192
520665	25/11/2022	NERO53 FERNET PREMIUM (mixta)	43 (Concedida) y 33 (Concedida)	Juan Ignacio Soria y Gaston Soria	172
520799	07/10/2022	AFINE (mixta)	31 (Concedida), 30 (Concedida) y 29 (Concedida)	LOGISTICA DEL PLATA S.R.L.	220
520806	07/10/2022	(figurativa)	33 (Concedida S/D), 32 (Concedida S/D), 31 (Concedida S/D), 30 (Concedida S/D) y 29 (Concedida S/D)	Foshan Haitian Flavouring & Food Co., Ltd.	144
521087	07/10/2022	GOTA VERDE	31 (Concedida)	Rosalía Ingold	
521443	11/10/2022	OMNIA	44 (Concedida S/D), 42 (Concedida S/D),	OMNIA HOLDINGS LIMITED	201

N° Exp	Resolución	Marca	Clases	Titular	Ag.
			31 (Concedida S/D), 9 (Concedida S/D) y 1 (Concedida S/D)		
521444	11/10/2022	OMNIA NUTRIOLOGY (mixta)	31 (Concedida S/D) y 1 (Concedida S/D)	OMNIA HOLDINGS LIMITED	201
521458	12/10/2022	AFFINITY ADVANCE	31 (Concedida S/D)	AFFINITY PETCARE, S.A.	181
521482	07/10/2022	OSMOFIT	31 (Concedida S/D)	Nutreco IP Assets B.V.	245
521487	07/10/2022	NUNHEMS (mixta)	44 (Concedida S/D), 31 (Concedida S/D) y 29 (Concedida S/D)	Nunhems B.V.	144
521551	19/10/2022	BLACK DEVIL	32 (Concedida S/D)	Font Salem, S.L.	181
521690	07/10/2022	APHIX (mixta)	31 (Concedida S/D)	Advanta Holdings BV	144
521838	17/10/2022	GLYCODE	31 (Concedida S/D) y 5 (Concedida S/D)	PMI Nutrition International, LLC	136
521841	17/10/2022	N NARANJINO (mixta)	33 (Concedida)	MORAES CHAVES ROSA MARY	212
521877	17/10/2022	TOKY (mixta)	31 (Concedida)	VELTOMAR S.A.	118
521913	17/10/2022	SATUS CALIDAD & CONFIANZA (mixta)	31 (Concedida S/D)	Satus Ager S.A.	144
521914	17/10/2022	SATUS QUALITY & TRUST (mixta)	31 (Concedida S/D)	Satus Ager S.A.	144
521918	17/10/2022	MICROLIFE	31 (Concedida S/D), 5 (Concedida S/D) y 1 (Concedida S/D)	PHIBRO ANIMAL HEALTH CORPORATION	194
521981	17/10/2022	GLORIA (mixta)	31 (Concedida)	GLORIA S.A.	144
521986	17/10/2022	GLORIA (mixta)	31 (Concedida)	GLORIA S.A.	144
521995	17/10/2022	GLORIA (mixta)	31 (Concedida)	GLORIA S.A.	144
521997	17/10/2022	QUATRO PATAS (mixta)	31 (Concedida S/D)	NUTRI SUL ALIMENTO ANIMAL LTDA	
522007	07/10/2022	GLORIA (mixta)	31 (Concedida)	GLORIA S.A.	144
522012	07/10/2022	GLORIA (mixta)	31 (Concedida)	GLORIA S.A.	144
522140	07/10/2022	BONLÉ (mixta)	31 (Concedida)	GLORIA S.A.	144
522145	07/10/2022	GLORIA (mixta)	31 (Concedida)	GLORIA S.A.	144

N° Exp	Resolución	Marca	Clases	Titular	Ag.
522150	07/10/2022	PIL ANDINA (mixta)	31 (Concedida)	GLORIA S.A.	144
522155	07/10/2022	GLORIA LIGHT (mixta)	31 (Concedida)	GLORIA S.A.	144
522160	07/10/2022	SOALÉ (mixta)	31 (Concedida)	GLORIA S.A.	144
522165	07/10/2022	GLORIA LECHE EVAPORADA SEMIDESCREMADA (mixta)	31 (Concedida)	GLORIA S.A.	144
522325	07/10/2022	STONEVILLE	31 (Concedida S/D) y 22 (Concedida S/D)	BASF Agricultural Solutions Seed US LLC	144
522373	07/10/2022	SAFE COMPLETE CARE COMPETENCE (mixta)	31 (Concedida S/D)	SAFE	144
522376	25/11/2022	CINZANO (mixta)	33 (Concedida S/D)	DAVIDE CAMPARI- MILANO N.V.	34
522467	07/10/2022	BV BAR DE VINOS (mixta)	43 (Concedida S/D), 41 (Concedida), 35 (Concedida) y 33 (Concedida S/D)	EL BAR DE VINOS LTDA	186
522533	12/10/2022	MERILIN (mixta)	44 (Concedida), 31 (Concedida) y 22 (Concedida)	SOCIEDAD DE CRIADORES DE MERILIN	233
522614	07/10/2022	FIBERMAX	31 (Concedida S/D) y 22 (Concedida S/D)	BASF Agricultural Solutions Seed US LLC	144
522679	07/10/2022	LA ESPORADA (mixta)	31 (Concedida S/D) y 29 (Concedida S/D)	Ledo Costabel	
522680	07/10/2022	TORREVIEJA	32 (Concedida), 31 (Concedida), 30 (Concedida), 29 (Concedida) y 5 (Concedida)	SOLSIRE S.A.	94
522681	07/10/2022	ST (mixta)	31 (Concedida), 30 (Concedida) y 5	SOLSIRE S.A.	94

N° Exp	Resolución	Marca	Clases	Titular	Ag.
			(Concedida)		
522783	03/10/2022	GRAMÍNEAS ESPACIO DE CRIANZA RESPETUOSA	41 (Concedida S/D)	Paola Rosano y Natalie Viacava	
522821	03/11/2022	PRESAGE	44 (Concedida)	Felizo S.A.	172
522824	07/10/2022	HALLMARK HIGHBALL	33 (Concedida S/D)	CEPAS URUGUAY BEBIDAS Y ALIMENTOS S.A.	34
522897	16/11/2022	SUPERMERCADO URUFRIO (mixta)	35 (Concedida)	Lorenzo Rosales, Facundo Agustín	28
522965	07/10/2022	FAURECIA (mixta)	12 (Concedida S/D), 9 (Concedida S/D) y 7 (Concedida S/D)	FAURECIA	34
523018	07/10/2022	GRAN MALO	33 (Concedida S/D)	LICORES Y DESTILADOS GRAN MALO, S.A.P.I. DE C.V.	94
523020	07/10/2022	EL ÚNICO GRAN MALO	33 (Concedida S/D)	LICORES Y DESTILADOS GRAN MALO, S.A.P.I. DE C.V.	94
523021	11/10/2022	VAMOS AL GRANO (mixta)	43 (Concedida), 35 (Concedida), 32 (Concedida), 31 (Concedida), 30 (Concedida) y 29 (Concedida)	ESPECIESEM SRL	212
523042	07/10/2022	INIA ABYDOS	31 (Concedida)	Instituto Nacional De Investigación Agropecuaria (Inia)	34
523044	07/10/2022	INIA OSIRIS	31 (Concedida)	INSTITUTO NACIONAL DE INVESTIGACION AGROPECUARIA (INIA)	34
523046	07/10/2022	INIA VALENTINA	31 (Concedida)	INSTITUTO NACIONAL DE INVESTIGACION AGROPECUARIA (INIA)	34
523073	11/10/2022	PREMIERPET (mixta)	31 (Concedida S/D)	GRANDFOOD INDUSTRIA E COMERCIO LTDA.	144
523079	07/10/2022	CREDENZ (mixta)	31 (Concedida S/D) y 1 (Concedida S/D)	BASF Agricultural Solutions Seed US LLC	144
523095	11/10/2022	BOSQUE GIN	33 (Concedida)	DESTILERIA PATAGONICA S.A.S	220

N° Exp	Resolución	Marca	Clases	Titular	Ag.
523146	07/10/2022	NNABIS (mixta)	31 (Concedida S/D)	Leonardo Melon	
523215	11/11/2022	PETRA (mixta)	25 (Concedida)	PETRA STORE SRL	34
523281	12/10/2022	TENTIK	16 (Concedida S/D), 12 (Concedida S/D), 11 (Concedida S/D), 9 (Concedida S/D) y 7 (Concedida S/D)	TRATON SE	240
523282	12/10/2022	(figurativa)	16 (Concedida S/D), 12 (Concedida S/D), 11 (Concedida S/D), 9 (Concedida S/D) y 7 (Concedida S/D)	TRATON SE	240
523284	24/10/2022	TAMBO FARMS	31 (Concedida S/D) y 1 (Concedida S/D)	Juan José Fernandez Tambolini	
523320	07/10/2022	CANFEED (mixta)	31 (Concedida S/D)	AGROSERVICIOS HUMBOLDT S.A.	34
523345	07/11/2022	AUSTRAL (mixta)	37 (Concedida S/D)	Jose Laborde	
523460	12/10/2022	KEEPER (mixta)	31 (Concedida), 30 (Concedida), 29 (Concedida), 21 (Concedida), 16 (Concedida), 5 (Concedida S/D) y 3 (Concedida)	FRONTOY S.A.	245
523464	12/10/2022	LA GUAYABERIA (mixta)	31 (Concedida), 30 (Concedida) y 29 (Concedida)	DE CASTRO LARRAECHEA, LUCIA	201
523483	12/10/2022	BROTE (mixta)	44 (Concedida), 41 (Concedida), 35 (Concedida) y 31 (Concedida)	JUAN ARBIZA LARA	160
523511	07/10/2022	TESAI	44 (Concedida), 43	TOFIRIX S.A.	144

N° Exp	Resolución	Marca	Clases	Titular	Ag.
			(Concedida), 41 (Concedida), 34 (Concedida), 33 (Concedida), 32 (Concedida), 31 (Concedida), 25 (Concedida), 5 (Concedida) y 3 (Concedida)		
523536	11/10/2022	HNOS. ARMAND UGON (mixta)	35 (Concedida), 31 (Concedida), 30 (Concedida) y 29 (Concedida)	Hnos Armand Ugon y Cia SA	220
523594	08/11/2022	CORAL APRECIO POR VOS (mixta)	35 (Concedida)	CADOREL S.A.	201
523651	12/10/2022	NORTHRUP KING	31 (Concedida S/D)	SYNGENTA PARTICIPATIONS AG	194
523654	12/10/2022	GARST	31 (Concedida S/D)	SYNGENTA PARTICIPATIONS AG	194
523688	28/10/2022	DONEGAL	33 (Concedida S/D)	Sazerac Brands, LLC	245
523767	28/10/2022	VAMO´ QUE PODEMOS	33 (Concedida)	STAGNARI MOISE, HECTOR MARIANO	201
523857	08/11/2022	CLENPULMIN	5 (Concedida)	RIPOLL VET S.A.	245
524004	17/10/2022	CAFÉ DECAUVILLE ALTA CALIDAD (mixta)	43 (Concedida S/D)	JAVIER MONTES FARINA	144
524044	24/10/2022	TRUST INDICATORS	41 (Concedida S/D)	THE TRUST PROJECT	94
524084	28/10/2022	HOUSE ONE (mixta)	42 (Concedida), 35 (Concedida) y 9 (Concedida)	Martin Mieres	
524097	12/10/2022	KENSING	42 (Concedida S/D) y 1 (Concedida S/D)	Kensing, LLC	212
524105	03/11/2022	ABSOLUT SINCE 1879 L.O. SMITH ABSOLUT VODKA SWEDISH VODKA COUNTRY OF SWEDEN (mixta)	33 (Concedida S/D)	The Absolut Company Aktiebolag	218

N° Exp	Resolución	Marca	Clases	Titular	Ag.
524158	17/10/2022	ALARIS	33 (Concedida S/D)	GRUPO PEÑAFLORES S.A.	94
524274	25/11/2022	GOLDEN HARVEST (mixta)	31 (Concedida S/D)	SYNGENTA PARTICIPATIONS AG	194
524304	11/11/2022	MIMAME	31 (Concedida S/D), 27 (Concedida S/D), 21 (Concedida S/D), 20 (Concedida S/D), 18 (Concedida S/D), 5 (Concedida S/D), 3 (Concedida S/D) y 1 (Concedida S/D)	Unilever Global IP Limited	136
524451	25/11/2022	ROYAL BLUE (mixta)	34 (Concedida S/D)	COMPAÑIA INDUSTRIAL DE TABACOS MONTE-PAZ S.A.	245
524499	25/11/2022	FORÇA DO BOI	33 (Concedida)	DIANA GUEDES y EUROPEAN COSMETICS LTDA	
524520	25/10/2022	IDENTITY (mixta)	33 (Concedida)	MAURO GIMÉNEZ	220
524523	24/10/2022	L LITHIUM SOFTWARE (mixta)	42 (Concedida S/D) y 9 (Concedida S/D)	ALFATOTAL S.A.	
524589	25/10/2022	BOTRAN	33 (Concedida S/D)	CB ENTERPRISE, INC.	34
524639	28/10/2022	TAURUS GOLD (mixta)	29 (Concedida)	Agropecuaria La Escalera SRL	212
524694	03/10/2022	LIF-E (mixta)	12 (Concedida)	VEROBLUE SA	220
524723	03/10/2022	HARRY'S BAR	43 (Concedida S/D)	ALTUNIS - TRADING, GESTÃO E SERVIÇOS SOCIEDADE UNIPESSOAL, LDA.	212
524738	03/10/2022	J (mixta)	3 (Concedida S/D)	JURLIQUE INTERNATIONAL PTY LTD	201
524741	03/10/2022	BIO-INTRINSIC METHOD (mixta)	3 (Concedida S/D)	JURLIQUE INTERNATIONAL PTY LTD	201
524752	03/10/2022	MISSION (mixta)	30 (Concedida S/D) y 29 (Concedida S/D)	Gruma, S.A.B. De C.V.	216
524755	03/10/2022	BERGANTIÑOS ORTOPEDIA (mixta)	35 (Concedida), 25 (Concedida) y 10 (Concedida S/D)	Bergantinos S.C.	144
524774	28/10/2022	EL INMADURO	33 (Concedida)	Finca El Consentido SRL	232

N° Exp	Resolución	Marca	Clases	Titular	Ag.
524777	28/10/2022	GRACIAS DAMAJUANA	33 (Concedida)	FAVRETTO NEGRO LUIS JOSE Y DRAGONE BO MEDARDA FELICIA SOCIEDAD DE HECHO	245
524778	28/10/2022	MEMORIAS	33 (Concedida)	FAVRETTO NEGRO LUIS JOSE Y DRAGONE BO MEDARDA FELICIA SOCIEDAD DE HECHO	245
524792	07/10/2022	MAXIONE LLANTAS Y NEUMÁTICOS R (mixta)	12 (Concedida S/D)	AUTECO MOBILITY S.A.S.	144
524859	25/11/2022	GARZÓN URUGUAY BODEGA GARZÓN URUGUAY LBV TANNSANTO (mixta)	33 (Concedida)	AGROLAND S.A.	216
524861	25/11/2022	SUNSET	33 (Concedida)	SENFOR S.A.	201
524875	25/11/2022	CANTERA MONTES DE OCA (mixta)	43 (Concedida), 35 (Concedida), 33 (Concedida), 32 (Concedida), 30 (Concedida) y 29 (Concedida)	Julio Andres Cantera Sención	101
524890	25/11/2022	CONDE MOLINA	33 (Concedida)	EUROPEAN COSMETICS LTDA	
524957	28/10/2022	CONTRACARA	33 (Concedida S/D)	SALENTEIN ARGENTINA B.V.	34
524960	07/10/2022	(figurativa)	11 (Concedida S/D) y 10 (Concedida S/D)	AUKEY TECHNOLOGY CO., LTD.	201
524992	03/10/2022	EXTRA EXTRA CENTENARIO	29 (Concedida)	FRIGORIFICO CENTENARIO S.A.	179
525097	25/11/2022	HIPHORIUS	31 (Concedida S/D) y 5 (Concedida S/D)	DSM IP Assets B.V.	201
525235	03/10/2022	OLÉ SEGUROS (mixta)	36 (Concedida S/D)	OLE CORRETORA DE SEGUROS LTDA	212
525271	07/10/2022	AADVANTAGE (mixta)	39 (Concedida S/D) y 35 (Concedida S/D)	AADVANTAGE LOYALTY IP LTD.	136
525305	11/11/2022	FRUMIX (mixta)	39 (Concedida), 35	GUSTAVO MARCELO AVELLANEDA	219

N° Exp	Resolución	Marca	Clases	Titular	Ag.
			(Concedida) y 31 (Concedida)	BIANCHI y SEBASTIAN EMANUEL DUBOIS JUANOTENA	
525309	11/11/2022	BLOOM A GROWTH COMPANY (mixta)	31 (Concedida S/D)	Pablo Parrilla	
525323	12/10/2022	KYNDRYL	42 (Concedida S/D), 41 (Concedida S/D), 38 (Concedida S/D), 37 (Concedida S/D), 35 (Concedida S/D) y 9 (Concedida S/D)	Kyndryl, Inc.	34
525324	12/10/2022	KYNDRYL (mixta)	42 (Concedida S/D), 41 (Concedida S/D), 38 (Concedida S/D), 37 (Concedida S/D), 35 (Concedida S/D) y 9 (Concedida S/D)	Kyndryl, Inc.	34
525338	12/10/2022	51	34 (Concedida S/D)	INDUSTRIAL CONQUISTADOR S.A.	144
525401	07/10/2022	Q QUINTA DISCIPLINA CONSULTORES (mixta)	42 (Concedida)	PPRM SRL	232
525435	11/11/2022	GOLAND (mixta)	35 (Concedida), 32 (Concedida), 31 (Concedida), 30 (Concedida), 29 (Concedida), 5 (Concedida) y 3 (Concedida)	GOLAND GROUP S.R.L.	
525466	07/10/2022	VERDE INVERSIONES	36 (Concedida S/D)	FUCAC VERDE COOPERATIVA DE AHORRO Y CREDITO	201
525525	25/11/2022	ORGANNACT (mixta)	31 (Concedida) y 5 (Concedida S/D)	SHEEP INDÚSTRIA E COMÉRCIO DE PRODUTOS AGROPECUÁRIOS LTDA	144
525563	25/11/2022	LOS CERROS DE SAN JUAN	31 (Concedida) y 30	SENFOR S.A.	201

N° Exp	Resolución	Marca	Clases	Titular	Ag.
			(Concedida)		
525577	25/11/2022	OPAH ORTIFRUTTI (mixta)	31 (Concedida)	Vicente Luis Rosano Carbonel	
525592	25/11/2022	VITROPLANT (mixta)	44 (Concedida), 42 (Concedida) y 31 (Concedida)	José Pintos y Mario Giambiasi Sociedad de Hecho	212
525619	16/11/2022	OTTONELLO JAMÓN COCIDO YORK (mixta)	31 (Concedida), 30 (Concedida) y 29 (Concedida S/D)	OTTONELLO HNOS. S.A.	194
525679	11/10/2022	HUMA RESTO BAR	43 (Concedida S/D)	NAMBI S.A.	184
525719	25/11/2022	AGROLAND (mixta)	44 (Concedida), 43 (Concedida), 35 (Concedida), 33 (Concedida) y 29 (Concedida)	AGROLAND S.A.	216
525752	16/11/2022	TEQERS	41 (Concedida S/D), 28 (Concedida S/D), 25 (Concedida S/D) y 18 (Concedida S/D)	TEQBALL HOLDING S.A.R.L.	212
525814	07/10/2022	NIX ENERGY DRINK (mixta)	32 (Concedida S/D)	MARZUREL S.A.	184
525932	07/10/2022	MIRÁ QUE LINDO	41 (Concedida S/D)	Gabriela Valero	
525940	17/10/2022	MARIO CAFÉ	43 (Concedida S/D)	MARIO H VIDALES & CIA. S.C.	201
525945	17/10/2022	MODO VIAJES (mixta)	39 (Concedida S/D)	Fragetur S.A.	201
525957	25/11/2022	LYPTUS	31 (Concedida S/D), 20 (Concedida S/D) y 19 (Concedida S/D)	URUPLY S.A.	218
525994	25/11/2022	NIKOV	33 (Concedida)	DESTILADOS ARGENTINOS S.A.	219
526012	24/10/2022	BC ENERGY INVESTMENTS CORP. (mixta)	42 (Concedida S/D) y 37 (Concedida S/D)	BC Energy Investments Corp.	245

N° Exp	Resolución	Marca	Clases	Titular	Ag.
526028	03/10/2022	CHLOE	24 (Concedida)	CHLOE S.A.S.	189
526029	03/10/2022	ÁMBAR	24 (Concedida)	CHLOE S.A.S.	189
526033	07/10/2022	EBMPAPST ENGINEERING A BETTER LIFE	42 (Concedida S/D), 11 (Concedida S/D), 9 (Concedida S/D) y 7 (Concedida S/D)	ebm-papst Mulfingen GmbH & Co. KG	201
526036	07/10/2022	1783 (mixta)	32 (Concedida)	European Refreshments	94
526039	07/10/2022	PORÁITE	35 (Concedida), 24 (Concedida) y 20 (Concedida)	BETIANA TREITAS CASTILLO	
526040	07/10/2022	CENTENARIO	36 (Concedida)	CAPELAR S.A.	94
526041	28/10/2022	AMIRA M (mixta)	11 (Concedida), 9 (Concedida) y 7 (Concedida)	NIDAL QASIM HUSEIN, RICARDO	201
526044	07/10/2022	KADRION	5 (Concedida S/D)	BASF SE	144
526047	07/10/2022	MICROGOMA (mixta)	17 (Concedida)	Hidroquímica Americana S.A.	34
526053	07/10/2022	VASATA	9 (Concedida S/D)	TP-LINK CORPORATION LIMITED	201
526059	07/10/2022	USX CARGO (mixta)	39 (Concedida) y 35 (Concedida)	Guillermo Faggiani	194
526063	07/10/2022	DIA-FRAG	17 (Concedida) y 12 (Concedida)	Wabtec Brasil Fabricação e Manutenção de Equipamentos Ltda.	194
526066	07/10/2022	A&N (mixta)	39 (Concedida) y 35 (Concedida)	Nicolás Petronco	194
526071	07/10/2022	LOOP ASPHERIC	10 (Concedida S/D)	Bausch + Lomb Ireland Limited	212
526072	07/10/2022	KEYANG (mixta)	7 (Concedida S/D)	KEYANG ELECTRIC MACHINERY CO., LTD.	181
526075	07/10/2022	MECA	35 (Concedida S/D)	Roberto Fernández	
526080	07/10/2022	SURKER	11 (Concedida) y 8 (Concedida)	LLANES BENTANCOR MAURICIO ANDRES	220
526083	07/10/2022	01 SYNC (mixta)	37 (Concedida), 36 (Concedida) y 19 (Concedida)	Vitrium Capital Uruguay S.A.	201

N° Exp	Resolución	Marca	Clases	Titular	Ag.
526085	07/10/2022	FLEXITEINT	3 (Concedida S/D)	L'OREAL	144
526086	07/10/2022	VUMI (mixta)	44 (Concedida S/D) y 36 (Concedida S/D)	VIP Universal Medical Insurance Group, LLC	154
526090	07/10/2022	H125	9 (Concedida S/D)	AIRBUS HELICOPTERS	165
526091	07/10/2022	H130	9 (Concedida S/D)	AIRBUS HELICOPTERS	165
526092	07/10/2022	H135	9 (Concedida S/D)	AIRBUS HELICOPTERS	165
526093	07/10/2022	H145	9 (Concedida S/D)	AIRBUS HELICOPTERS	165
526094	07/10/2022	H155	9 (Concedida S/D)	AIRBUS HELICOPTERS	165
526095	07/10/2022	H175	9 (Concedida S/D)	AIRBUS HELICOPTERS	165
526096	07/10/2022	H215	9 (Concedida S/D)	AIRBUS HELICOPTERS	165
526097	07/10/2022	H225	9 (Concedida S/D)	AIRBUS HELICOPTERS	165
526112	11/10/2022	PATCH BAGS (mixta)	18 (Concedida S/D)	Lucía Poñachik Rubiolo	212
526118	11/10/2022	VACARTEL	42 (Concedida S/D), 40 (Concedida S/D), 35 (Concedida S/D) y 16 (Concedida S/D)	Fullprint SRL	
526182	07/10/2022	EFFECTUS (mixta)	42 (Concedida) y 35 (Concedida)	EFFECTUS URUGUAY LTDA	216
526189	11/10/2022	OIDO AMIGO (mixta)	44 (Concedida)	ASOCIACION URUGUAYA DE LOS ADVENTISTAS DEL SEPTIMO DIA	247
526210	24/10/2022	RCD RECICLAJE (mixta)	40 (Concedida S/D)	RCD RECICLAJE SAS	212
526218	07/10/2022	DOK	25 (Concedida S/D)	"Dr. Martens" International Trading GmbH y "Dr. Maertens" Marketing GmbH	136
526228	14/11/2022	TERRA FERTIL (mixta)	1 (Concedida S/D)	MILTAY S.A.	144
526263	03/10/2022	NEGS	3 (Concedida S/D)	GOOD BRANDS EIRL	144
526278	24/10/2022	OPENSOLO (mixta)	35 (Concedida S/D)	FIDOCARMA SA	144
526286	24/10/2022	NORFEN (mixta)	9 (Concedida S/D)	Joaquin Pirez	
526297	24/10/2022	PRESTAMO VERDE	36 (Concedida S/D)	FUCAC VERDE COOPERATIVA DE AHORRO Y CREDITO	201

N° Exp	Resolución	Marca	Clases	Titular	Ag.
526366	17/10/2022	ALCOHOL 70% VOL. EUCALIPTADO ANCAP ALCOHOL ETÍLICO EUCALIPTADO 70% VOL. (mixta)	5 (Concedida S/D) y 1 (Concedida S/D)	ADMINISTRACION NACIONAL DE COMBUSTIBLES ALCOHOL Y PORTLAND	201
526368	25/11/2022	ALCOHOL 95% VOL. RECTIFICADO ANCAP ALCOHOL ETÍLICO RECTIFICADO 95% VOL. (mixta)	5 (Concedida S/D) y 1 (Concedida S/D)	ADMINISTRACION NACIONAL DE COMBUSTIBLES ALCOHOL Y PORTLAND	201
526370	25/11/2022	ALCOHOL EN GEL ANCAP CLÁSICO (mixta)	5 (Concedida S/D) y 1 (Concedida S/D)	ADMINISTRACION NACIONAL DE COMBUSTIBLES ALCOHOL Y PORTLAND	201
526371	25/11/2022	ALCOHOL EN GEL ANCAP LAVANDA (mixta)	5 (Concedida S/D) y 1 (Concedida S/D)	ADMINISTRACION NACIONAL DE COMBUSTIBLES ALCOHOL Y PORTLAND	201
526372	25/11/2022	ALCOHOL 70% VOL. USO FARMACÉUTICO ANCAP ALCOHOL ETÍLICO RECTIFICADO 70% VOL. (mixta)	5 (Concedida S/D) y 1 (Concedida S/D)	ADMINISTRACION NACIONAL DE COMBUSTIBLES ALCOHOL Y PORTLAND	201
526383	25/11/2022	ALTA RESERVA	33 (Concedida)	GIMENEZ MENDEZ S.R.L.	220
526436	07/10/2022	ONE HEALTH CIRCULAR HEALTH FATRO ECO HEALTH CIRCULAR HEALTH FATRO (mixta)	5 (Concedida S/D)	FATRO S.P.A.	192
526456	03/10/2022	WORLD GREEN NUTRITION	39 (Concedida S/D) y 5 (Concedida S/D)	WORLD GREEN NUTRITION, INC	94
526458	03/10/2022	WORLD GREEN PROPERTIES	36 (Concedida S/D)	WORLD GREEN NUTRITION, INC	94
526468	03/10/2022	PARQUE LOGISTICO SAN JUAN (mixta)	39 (Concedida)	SAMMEL S.A.	34
526481	03/10/2022	NH NUTRIHEALTH (mixta)	5 (Concedida)	LAKS, GABRIELA	201
526483	15/11/2022	KELCO KELDOG (mixta)	31 (Concedida S/D)	KELCO PET CARE PRODUTOS ANIMAIS LTDA.	
526485	15/11/2022	KELCO KELCAT (mixta)	31 (Concedida S/D)	KELCO PET CARE PRODUTOS ANIMAIS LTDA.	
526487	15/11/2022	KELCO PIPICAT (mixta)	31 (Concedida S/D)	KELCO PET CARE PRODUTOS ANIMAIS LTDA.	181
526491	07/10/2022	DINERO PLUS	42 (Concedida), 36	Marketplace Investments LLC	94

N° Exp	Resolución	Marca	Clases	Titular	Ag.
			(Concedida), 35 (Concedida) y 9 (Concedida)		
526492	15/11/2022	INZEN	31 (Concedida S/D) y 1 (Concedida S/D)	Corteva Agriscience LLC	194
526497	03/10/2022	INTERLEX GLOBAL LAW FIRM NETWORK (mixta)	45 (Concedida S/D), 41 (Concedida S/D) y 16 (Concedida S/D)	The Interlex Group	192
526499	15/11/2022	CUORETIERRA (mixta)	31 (Concedida)	Darío Gabriel Martínez Guedes	
526563	25/11/2022	BAR AROCENA DESDE 1929 (mixta)	43 (Concedida S/D)	JOSE LUIS MALLON ESTEIRO	118
526599	25/11/2022	HIJO DE TIGRE	33 (Concedida S/D)	LLANES RIOS SEBASTIAN	
526600	28/10/2022	HIJO DE TIGRE (mixta)	33 (Concedida S/D)	LLANES RIOS SEBASTIAN	
526630	11/11/2022	ARMIÑO	41 (Concedida), 32 (Concedida), 31 (Concedida), 30 (Concedida) y 29 (Concedida)	SOLDO HNOS. S.A.	245
526659	03/10/2022	CHULEBANANA	14 (Concedida)	Juliana Etchegoyhen	194
526662	03/10/2022	GUISSENY	3 (Concedida)	Unión S.R.L.	34
526663	03/10/2022	PLANET SPA	4 (Concedida S/D)	AVON PRODUCTS, INC.	194
526666	03/10/2022	PRIORÍZATE (mixta)	35 (Concedida), 25 (Concedida) y 14 (Concedida)	Ruth Schatz	
526668	03/10/2022	SUPERSONIC	8 (Concedida S/D)	DART INDUSTRIES INC.	34
526669	03/10/2022	AMALGAMA A (mixta)	41 (Concedida)	VICENTE, NATALIA MARIANA	245
526672	07/10/2022	MUJERES SANADORAS (mixta)	41 (Concedida) y 16 (Concedida)	CARINA LILIAN ERRICO GONZALEZ	212
526675	03/10/2022	PX7 PROFESIONAL	3 (Concedida S/D)	Diego Estefanell Silveira	
526679	03/10/2022	ZEPIX	5 (Concedida)	BALIARDA S.A.	201
526680	07/10/2022	BARRACUDA	12 (Concedida)	JET IMPORTACIONES S.R.L.	201

N° Exp	Resolución	Marca	Clases	Titular	Ag.
526681	07/10/2022	INCONCERT	9 (Concedida)	TECNOLINK S.A.	156
526682	07/10/2022	ALTUVIIIIO	5 (Concedida S/D)	Bioverativ Therapeutics Inc.	144
526683	07/10/2022	LIXENTA	5 (Concedida)	MEGA LABS S.A.	144
526687	07/10/2022	TBANKS (mixta)	42 (Concedida S/D) y 9 (Concedida S/D)	TIVIT TERCEIRIZAÇÃO DE PROCESSOS, SERVIÇOS E TECNOLOGIA S/A	144
526688	07/10/2022	PGM ACTIVE	1 (Concedida S/D)	UPL Corporation Ltd	144
526689	11/11/2022	LA BAGUALA (mixta)	41 (Concedida), 33 (Concedida), 32 (Concedida), 31 (Concedida) y 29 (Concedida)	MAR DE HIERBAS S.A.	194
526690	11/11/2022	STONEVILLE (mixta)	31 (Concedida S/D) y 22 (Concedida S/D)	BASF Agricultural Solutions Seed US LLC	144
526691	07/10/2022	IFFALCON	7 (Concedida)	SHENZHEN TCL NEW TECHNOLOGY CO., LTD.	201
526692	07/10/2022	RUNNING ® (mixta)	25 (Concedida S/D)	Michael CHIRIFF FRACCIA	
526694	07/10/2022	COCA-COLA (mixta)	32 (Concedida)	THE COCA-COLA COMPANY	94
526695	07/10/2022	IFFALCON	11 (Concedida)	SHENZHEN TCL NEW TECHNOLOGY CO., LTD.	201
526696	07/10/2022	(figurativa)	7 (Concedida)	SHENZHEN TCL NEW TECHNOLOGY CO., LTD.	201
526697	07/10/2022	(figurativa)	9 (Concedida)	SHENZHEN TCL NEW TECHNOLOGY CO., LTD.	201
526698	07/10/2022	DURADUO	5 (Concedida)	SERVIMEDIC S.A.	144
526699	07/10/2022	(figurativa)	11 (Concedida)	SHENZHEN TCL NEW TECHNOLOGY CO., LTD.	201
526703	28/10/2022	POPCORNERS	30 (Concedida) y 29 (Concedida)	BFY BRANDS, LLC	201
526706	03/10/2022	HAPPY SALE ACHER (mixta)	35 (Concedida)	HEY'DI URUGUAYA S.A.	219
526716	07/10/2022	I FEEL FOOD (mixta)	35 (Concedida) y 29	GRUPO BIMBO S.A.B. DE C.V.	181

N° Exp	Resolución	Marca	Clases	Titular	Ag.
			(Concedida)		
526718	07/10/2022	BIMBO CERO CERO	30 (Concedida)	GRUPO BIMBO S.A.B. DE C.V.	181
526721	07/10/2022	EL TRÉBOL ESTUDIO CONTABLE (mixta)	35 (Concedida)	MUNIZ CALCAGNO, LUIS PAULO	201
526722	07/10/2022	MARINELA CHOCO BIT	30 (Concedida)	GRUPO BIMBO S.A.B. DE C.V.	181
526725	07/10/2022	KONITA NEW MATERIALS (mixta)	16 (Concedida S/D), 7 (Concedida S/D) y 1 (Concedida S/D)	Zhejiang Konita New Materials CO., LTD	94
526736	07/10/2022	FACZEED	5 (Concedida S/D)	Bioverativ Therapeutics Inc.	144
526737	07/10/2022	BIVTEFA	5 (Concedida S/D)	Bioverativ Therapeutics Inc.	144
526739	07/10/2022	VIAFIRMA (mixta)	42 (Concedida S/D)	VIAFIRMA S.L.	144
526741	07/10/2022	WOWMALL (mixta)	42 (Concedida) y 9 (Concedida)	URBIPORT S.A.	201
526742	07/10/2022	E EBROMAR MUCAD (mixta)	3 (Concedida)	Ebromar S.A.	144
526748	07/10/2022	(figurativa)	5 (Concedida S/D)	Eisai R&D Management Co., Ltd.	136
526752	12/10/2022	ESTRELLA GALICIA (mixta)	32 (Concedida)	Hijos de Rivera, S.A.	144
526754	12/10/2022	(figurativa)	5 (Concedida S/D)	Eisai R&D Management Co., Ltd.	136
526758	12/10/2022	CHABAS (mixta)	25 (Concedida)	VISCA GORRIA MARIA GABRIELA Y ROCHA MARTINEZ PAULO DANILO SOCIEDAD DE HECHO	220
526759	28/10/2022	ESTUDIO POSADAS	45 (Concedida), 42 (Concedida), 41 (Concedida), 36 (Concedida) y 35 (Concedida)	POSADAS, POSADAS & VECINO SOCIEDAD CIVIL	34
526760	28/10/2022	POSADAS	45 (Concedida), 42 (Concedida), 41 (Concedida), 36 (Concedida) y 35 (Concedida)	POSADAS, POSADAS & VECINO SOCIEDAD CIVIL	34
526761	04/11/2022	FORESTA PAISAJISMO (mixta)	44 (Concedida S/D)	CARRERO PONS, CRISTIAN GONZALO	34

N° Exp	Resolución	Marca	Clases	Titular	Ag.
526764	17/10/2022	TDX CONSTRUCCIONES VIALES Y CIVILES (mixta)	37 (Concedida)	TENDANIX S.A.	163
526768	17/10/2022	9 ELEMENTS (mixta)	3 (Concedida S/D)	The Procter & Gamble Company	212
526770	17/10/2022	FOODIE SIMPLE, RICO Y SALUDABLE. (mixta)	35 (Concedida S/D) y 29 (Concedida S/D)	Homero Maria Nolla y Inés Frolik	
526781	17/10/2022	RODATECH AUTOMOTIVE (mixta)	35 (Concedida)	VAZQUEZ LOYA, FIDENCIO	201
526782	17/10/2022	CONGA	7 (Concedida S/D)	CECOTEC RESEARCH AND DEVELOPMENT, S.L.	201
526783	17/10/2022	CONGA ROCKSTAR (mixta)	7 (Concedida S/D)	CECOTEC RESEARCH AND DEVELOPMENT, S.L.	201
526784	17/10/2022	MAMBO	7 (Concedida S/D)	CECOTEC RESEARCH AND DEVELOPMENT, S.L.	201
526786	24/10/2022	PASEOS EN FAMILIA	41 (Concedida) y 28 (Concedida)	Virginia Coubrough	154
526787	17/10/2022	BUXIS	42 (Concedida) y 9 (Concedida S/D)	Alvaro Darío Vigliola	154
526788	24/10/2022	AIRES DE CAMPO (mixta)	25 (Concedida)	Catherine Oliver y Martina Bruné	167
526790	24/10/2022	CIC	24 (Concedida S/D) y 20 (Concedida S/D)	Compañías CIC S.A.	181
526791	24/10/2022	ENCORA (mixta)	42 (Concedida S/D)	Encora Holdings Limited	216
526792	24/10/2022	ELTULVY	5 (Concedida S/D)	Bioverativ Therapeutics Inc.	165
526793	24/10/2022	LOLITAS	30 (Concedida)	Juan Carlos Roda Hernández	144
526795	24/10/2022	MILESTAR	12 (Concedida S/D)	Tireco, Inc.	179
526798	24/10/2022	FABIFLU	5 (Concedida)	URUFARMA S.A.	34
526799	24/10/2022	BATERAX (mixta)	9 (Concedida S/D)	BATERAX INDUSTRIA E COMERCIO DE ACUMULADORES LTDA.	34
526802	25/11/2022	HOTEL ROMIMAR (mixta)	43 (Concedida S/D)	Walter Rolando Lopez	181
526833	25/11/2022	CASAS G ACUERDOS INMOBILIARIOS (mixta)	36 (Concedida S/D)	GONZALEZ BARU LEONARDO GABRIEL Y GONZALEZ HERRERA MARCOS SOCIEDAD	194

N° Exp	Resolución	Marca	Clases	Titular	Ag.
				DE HECHO	
526837	25/11/2022	NUESTRO PAN, SALUDABLE SIN GLUTEN	30 (Concedida S/D)	TOMASI ZUNINO, ENRIQUE	201
526849	07/10/2022	FARMACITY SKIN	5 (Concedida) y 3 (Concedida)	FARMACITY S.A.	245
526872	07/10/2022	AIRSHOCK	25 (Concedida S/D) y 18 (Concedida S/D)	GRUPO FLEXI DE LEÓN, S.A.P.I. DE C.V	181
526891	07/10/2022	AIRSHOCK (mixta)	25 (Concedida S/D) y 18 (Concedida S/D)	GRUPO FLEXI DE LEÓN, S.A.P.I. DE C.V	181
526893	17/10/2022	BEAUTY CLUB EXPERTAS EN SER ÚNICAS (mixta)	36 (Concedida) y 35 (Concedida)	COBOE S.A	212
526902	07/10/2022	KOKOWEI	25 (Concedida S/D)	Zhang Wendu	245
526903	07/10/2022	KICKS (mixta)	35 (Concedida S/D) y 25 (Concedida S/D)	SPORTLINE AMERICA INC.	34
526904	07/10/2022	FEMIGEL	5 (Concedida)	CRAVERI S.A.	144
526906	07/10/2022	ISABEL MARIA IM (mixta)	25 (Concedida) y 18 (Concedida)	FREDERICK, JOSEFINA	245
526907	07/10/2022	KELER	32 (Concedida S/D)	Sociedad Anónima Damm	181
526910	07/10/2022	V VERSUS JEANS (mixta)	35 (Concedida) y 25 (Concedida S/D)	Leonardo Javier Barcelo Bentancur	144
526913	17/10/2022	DE ARRIBA UN RAYO	35 (Concedida), 25 (Concedida), 18 (Concedida) y 9 (Concedida)	TUBÍO RODRÍGUEZ, JUAN JOSÉ	189
526914	07/10/2022	TRAINING PONETE EN MOVIMIENTO (mixta)	35 (Concedida) y 25 (Concedida)	GASWIL S.A.	21
526922	07/10/2022	FORBES	41 (Concedida S/D), 16 (Concedida S/D)	Forbes LLC	218

N° Exp	Resolución	Marca	Clases	Titular	Ag.
			y 9 (Concedida S/D)		
526928	07/10/2022	TRE SAPORI (mixta)	43 (Concedida) y 30 (Concedida)	POSEDI S.R.L.	212
526929	07/10/2022	SPORTLINE AMERICA (mixta)	25 (Concedida S/D)	SPORTLINE AMERICA INC.	34
526934	07/10/2022	LN LUMINOVA PHARMA GROUP (mixta)	5 (Concedida S/D)	LUMINOVA PHARMA CORPORATION GmbH	202
526937	07/10/2022	SERVIPORT SECURITY SOLUTIONS	45 (Concedida S/D) y 37 (Concedida S/D)	Mauricio Xavier y Elisa Fonseca	
526940	07/10/2022	ASEPXIA GEN	3 (Concedida)	GENOMMA LAB INTERNACIONAL, S.A.B. DE C.V.	245
526945	07/10/2022	ASEPXIA GENOMMA	3 (Concedida)	GENOMMA LAB INTERNACIONAL, S.A.B. DE C.V.	245
526946	07/10/2022	ASEPXIA GENÉTICA	3 (Concedida)	GENOMMA LAB INTERNACIONAL, S.A.B. DE C.V.	245
526947	07/10/2022	ASEPXIA GEN	5 (Concedida)	GENOMMA LAB INTERNACIONAL, S.A.B. DE C.V.	245
526948	07/10/2022	ASEPXIA GENOMMA	5 (Concedida)	GENOMMA LAB INTERNACIONAL, S.A.B. DE C.V.	245
526949	07/10/2022	ASEPXIA GENÉTICA	5 (Concedida)	GENOMMA LAB INTERNACIONAL, S.A.B. DE C.V.	245
526952	07/10/2022	TOUCH ME BY GROOMEN	3 (Concedida)	GENOMMA LAB INTERNACIONAL, S.A.B. DE C.V.	245
526955	07/10/2022	URECURE-A	3 (Concedida)	GENOMMA LAB INTERNACIONAL, S.A.B. DE C.V.	245
526956	07/10/2022	KARBOON BY GROOMEN	3 (Concedida)	GENOMMA LAB INTERNACIONAL, S.A.B. DE C.V.	245
526958	07/10/2022	KARBOON BY GROOMEN	8 (Concedida)	GENOMMA LAB INTERNACIONAL, S.A.B. DE C.V.	245
526960	17/10/2022	CO2 NEUTRAL (mixta)	3 (Concedida S/D)	GENOMMA LAB INTERNACIONAL, S.A.B. DE C.V.	245

N° Exp	Resolución	Marca	Clases	Titular	Ag.
526961	07/10/2022	MULTICAMIONES	42 (Concedida S/D), 39 (Concedida S/D), 38 (Concedida S/D) y 35 (Concedida S/D)	FEDERICO NICOLÁS GONZALEZ GARCIA	
526963	07/10/2022	GROOMEN PINK	3 (Concedida)	GENOMMA LAB INTERNACIONAL, S.A.B. DE C.V.	245
526964	07/10/2022	GROOMEN PINK	8 (Concedida)	GENOMMA LAB INTERNACIONAL, S.A.B. DE C.V.	245
526965	17/10/2022	SUEROX FUSION	5 (Concedida)	GENOMMA LAB INTERNACIONAL, S.A.B. DE C.V.	245
526966	07/10/2022	SUEROX FUSSION	5 (Concedida)	GENOMMA LAB INTERNACIONAL, S.A.B. DE C.V.	245
526967	17/10/2022	SUEROX FUSION	32 (Concedida)	GENOMMA LAB INTERNACIONAL, S.A.B. DE C.V.	245
526968	07/10/2022	SUEROX FUSSION	32 (Concedida)	GENOMMA LAB INTERNACIONAL, S.A.B. DE C.V.	245
526970	17/10/2022	ICE HAUS	30 (Concedida S/D)	Fabrizio Brasesco; Ezequiel Delpino Dorado y Fernando Gabriel Núñez Dios	
526979	07/10/2022	DTECTS REHABILITACIÓN OLFATORIA (mixta)	10 (Concedida S/D) y 5 (Concedida S/D)	SIGRID GROUP SAS	
526980	07/10/2022	TAMARINDO (mixta)	43 (Concedida)	FIBAMAR S.A.	94
526982	17/10/2022	THE WELLNESS LAB MEDICINA FUNCIONAL ENDOCANNABINOLOGIA (mixta)	44 (Concedida)	MARIA FERNANDA COUTINHO da SILVA TORT	
526995	17/10/2022	SOUTHRING THE SOUTHERN FRONTIER SEAFOODS (mixta)	35 (Concedida S/D) y 29 (Concedida S/D)	AUSTRALIS MAR S.A.	34
526996	07/10/2022	VIRIDIA	42 (Concedida S/D), 37 (Concedida S/D), 36 (Concedida S/D)	LM VENTES	212

N° Exp	Resolución	Marca	Clases	Titular	Ag.
			y 35 (Concedida S/D)		
526999	07/10/2022	ACE ADVANCED CORNEAL EXPLORER (mixta)	10 (Concedida S/D)	Technolas Perfect Vision GmbH	212
527004	07/10/2022	CONDONES DILDO	10 (Concedida S/D)	ZUNINO SATRAGNI, AGUSTIN	189
527007	03/10/2022	JBROMERO	41 (Concedida)	José Benito Romero Sum	
527008	03/10/2022	CAFFEGIANO	29 (Concedida)	LOGISTICA DEL PLATA S.R.L.	220
527009	07/10/2022	ZONA SALTO	39 (Concedida S/D)	Gonzalo Troche	
527010	07/10/2022	DAP SALTO	39 (Concedida S/D)	Gonzalo Troche	
527011	07/10/2022	HN BARRACA HIERROS NITECA (mixta)	35 (Concedida)	BARRACA HN TERRA PEREIRA SAS	201
527019	03/10/2022	LAS CAMPANAS VIDA DE CAMPO (mixta)	35 (Concedida)	Matias Beer y Virazen S.A.	144
527020	03/10/2022	DESALAMBRE (mixta)	35 (Concedida)	Matias Beer y Virazen S.A.	144
527024	17/10/2022	VESPA VXL	12 (Concedida S/D)	PIAGGIO & C. S.P.A.	144
527032	07/10/2022	RUTH CARE (mixta)	3 (Concedida S/D)	UNIÃO FABRIL EXPORTADORA S.A.	34
527039	07/10/2022	YUNEX TRAFFIC	42 (Concedida S/D), 41 (Concedida S/D), 39 (Concedida S/D), 37 (Concedida S/D), 35 (Concedida S/D), 12 (Concedida S/D) y 9 (Concedida S/D)	Yunex GmbH	219
527040	03/10/2022	PIMI (mixta)	25 (Concedida)	Jackelin Sofía Barrantes Ayala	179
527041	07/10/2022	CELESTE (mixta)	25 (Concedida)	Jackelin Sofía Barrantes Ayala	179
527042	07/10/2022	TENIS POINT (mixta)	41 (Concedida)	CAMBON SILVA MARTIN SEBASTIAN, ROSELLI REBORI LEANDRO Y OTROS SOCIEDAD DE HECHO	194
527047	03/10/2022	CHILLOS	25 (Concedida S/D)	Wolverine Outdoors, Inc.	194
527048	15/11/2022	NUTEX NUTRITION EXPERIENCE (mixta)	31 (Concedida)	FODIMOR S.A.	94

N° Exp	Resolución	Marca	Clases	Titular	Ag.
527049	07/10/2022	CONVERGINT (mixta)	42 (Concedida S/D) y 37 (Concedida S/D)	Convergint Technologies LLC	216
527050	07/10/2022	CONVERGINT	42 (Concedida S/D) y 37 (Concedida S/D)	Convergint Technologies LLC	216
527055	07/10/2022	+BRASAS (mixta)	4 (Concedida)	Pablo Ruso	212
527063	03/10/2022	CANNAMAX	44 (Concedida S/D)	Octabel SAS	
527066	03/10/2022	VIDA PROSPERA	25 (Concedida S/D)	Gustavo Rodriguez	
527067	07/10/2022	THRIVING LIFE	25 (Concedida S/D)	Gustavo Rodriguez	
527072	03/10/2022	¡MANOS A LA OBRA! (mixta)	2 (Concedida)	POLAKOF Y CIA S.A.	94
527073	07/10/2022	HELPSTORE (mixta)	35 (Concedida) y 9 (Concedida)	HELP STORE SAS	201
527076	03/10/2022	HERMANDAD	30 (Concedida) y 29 (Concedida)	Guemiper Srl	181
527078	07/10/2022	V (mixta)	25 (Concedida S/D)	Vans, Inc.	136
527080	07/10/2022	DIA DE LOS HIJOS (mixta)	35 (Concedida)	BOLSA DE COMERCIO S.A.	144
527081	03/10/2022	V (mixta)	25 (Concedida S/D)	Vans, Inc.	136
527090	07/10/2022	ARC	10 (Concedida S/D)	Starkey Laboratories, Inc.	194
527091	03/10/2022	AVON LOV U (mixta)	3 (Concedida S/D)	AVON PRODUCTS, INC.	194
527095	07/10/2022	RURALLINK	9 (Concedida S/D)	HUAWEI TECHNOLOGIES CO., LTD.	34
527096	07/10/2022	FIXPLAN	5 (Concedida S/D)	SYNTEX S.A.	34
527097	07/10/2022	FIXPLAN-R	5 (Concedida S/D)	SYNTEX S.A.	34
527098	07/10/2022	KING LONG (mixta)	12 (Concedida)	Claudio Rafael Querol Netto y Julio Sebastián López Plavan	212
527099	07/10/2022	AZUL WIFI (mixta)	38 (Concedida S/D)	AZUL S.A.	34
527100	07/10/2022	OCHO NUDOS	43 (Concedida)	Mauro Roibal	212
527101	07/10/2022	COLINA BIER (mixta)	32 (Concedida S/D)	VIVANT ASSESSORIA COMERCIAL LTDA.	34
527103	07/10/2022	PICCOLINO (mixta)	30 (Concedida S/D)	Pedro Pivotto	
527105	07/10/2022	COLON VITAL GYM (mixta)	41 (Concedida)	Leonardo Taranto	

N° Exp	Resolución	Marca	Clases	Titular	Ag.
527106	07/10/2022	NAILSCOK	44 (Concedida S/D)	CELINA BONINI	
527109	07/10/2022	ZORBA (mixta)	41 (Concedida)	osvaldo carratú	
527114	12/10/2022	EPICA STAR (mixta)	8 (Concedida S/D)	MINGZHAN IMPORT & EXPORT CO.,LTD	201
527119	07/10/2022	AZOPT	5 (Concedida S/D)	NOVARTIS AG.	201
527120	07/10/2022	MCCANN (mixta)	42 (Concedida S/D), 35 (Concedida S/D) y 9 (Concedida S/D)	McCann-Erickson Marketing, Inc.	94
527121	07/10/2022	MCCANN	42 (Concedida S/D), 35 (Concedida S/D) y 9 (Concedida S/D)	McCann-Erickson Marketing, Inc.	94
527124	07/10/2022	CHIAGRAAL (mixta)	32 (Concedida), 29 (Concedida) y 3 (Concedida S/D)	Chiagraal SAS	144
527132	07/10/2022	PERMUTAFACIL (mixta)	35 (Concedida)	Federico Fernández y Diego Santos	
527137	07/10/2022	GXC	42 (Concedida)	GXC S.A.	172
527140	07/10/2022	¡VAMOS EQUIPO! ESCUELA- DEPORTE-COMUNIDAD (mixta)	41 (Concedida S/D)	SECRETARIA NACIONAL DEL DEPORTE	
527143	07/10/2022	TECNOWEB TECNOLOGÍA Y RESPALDO (mixta)	37 (Concedida) y 35 (Concedida)	TECNOWEB SRL	216
527145	07/10/2022	LUCHADORAS	45 (Concedida), 41 (Concedida), 38 (Concedida) y 35 (Concedida)	ANDRES GALLO DUBOURG	220
527146	07/10/2022	LA PATRIADA	45 (Concedida), 41 (Concedida), 38 (Concedida) y 35 (Concedida)	ANDRES GALLO DUBOURG	220
527147	07/10/2022	NO TE RINDAS	45 (Concedida), 41 (Concedida), 38 (Concedida) y 35 (Concedida)	ANDRES GALLO DUBOURG	220

N° Exp	Resolución	Marca	Clases	Titular	Ag.
527149	07/10/2022	ASURFII (mixta)	5 (Concedida S/D)	OTSUKA PHARMACEUTICAL Co., Ltd.	34
527156	07/10/2022	100 URUGUAYOS DICEN	41 (Concedida S/D)	FremantleMedia Netherland BV	34
527159	17/10/2022	PURO MALTE CERVEZA AGUA CEBADA LUPULO CERVEZA PURA MALTA (mixta)	32 (Concedida S/D)	CERVEJARIA CIDADE IMPERIAL PETRÓPOLIS LTDA	34
527164	07/10/2022	CUBOX CONTAINERS URUGUAY (mixta)	6 (Concedida S/D)	PEZZANO MARTINEZ GABRIEL HERNAN, TORII MARINI MAXIMILIANO KAYUSHI Y OTROS SOCIEDAD DE HECHO	
527171	07/10/2022	PRIMER PENSAMIENTO, MEJOR PENSAMIENTO	41 (Concedida) y 9 (Concedida)	Sebastián Estévez Tato y Sebastián Fernández Migliarina	212
527175	07/10/2022	LOS CARDINALES	36 (Concedida)	Federico Ricardo Delgue Alvez	181
527176	07/10/2022	ZARA ORIGINS	25 (Concedida), 18 (Concedida), 14 (Concedida) y 9 (Concedida)	INDUSTRIA DE DISEÑO TEXTIL, S.A. (INDITEX, S.A.)	201
527177	07/10/2022	MAXON OIL (mixta)	4 (Concedida S/D)	TECLUB INDÚSTRIA E COMÉRCIO DE LUBRIFICANTES LTDA.	212
527179	07/10/2022	SANTALU	25 (Concedida)	AUGUSTO NUÑEZ LOURIDO	202
527182	07/10/2022	KENTA. (mixta)	25 (Concedida) y 18 (Concedida)	DIEGO POZIOMEK	192
527201	07/10/2022	DTECTS KIT	10 (Concedida S/D) y 5 (Concedida S/D)	SIGRID GROUP SAS	
527203	07/10/2022	AEK CYBER (mixta)	9 (Concedida)	ROLACOR S. A.	220
527204	07/10/2022	M MITRA CONSULTORES (mixta)	35 (Concedida)	Javier Domínguez	181
527206	17/10/2022	CAPRINO SI ES DE CABRA ES DE CAPRINO CAPRINO ALTO PRODUCTOS PREMIUM (mixta)	29 (Concedida S/D)	Florencia Lizziero	
527207	17/10/2022	AMBIPAR RESPONSE (mixta)	41 (Concedida S/D) y 39 (Concedida S/D)	AMBIPAR PARTICIPAÇÕES E EMPREENHIMENTOS S.A.	34

N° Exp	Resolución	Marca	Clases	Titular	Ag.
527208	07/10/2022	(figurativa)	25 (Concedida) y 18 (Concedida)	JUAN ARTOLA PUERTA	34
527209	07/10/2022	BE EDUCATION CAMPUS (mixta)	41 (Concedida S/D)	CECILIA DE LA PAZ SUZACQ	34
527212	07/10/2022	CUMPL0360 (mixta)	9 (Concedida)	BRODITEC S.A	212
527213	07/10/2022	CALDERO	28 (Concedida)	Cuñarro Duhalde, Marcela	245
527218	07/10/2022	PUNTA DEL ESTE WEST SIDE (mixta)	43 (Concedida), 41 (Concedida) y 36 (Concedida)	TRELLES MONTEVERDI, GUSTAVO MARIA	245
527222	07/10/2022	CLICK & DRIVE (mixta)	41 (Concedida S/D)	Fernando Romero	
527223	07/10/2022	FESTILINDO	41 (Concedida) y 38 (Concedida)	GROZAV MEDIA LLC	220
527230	25/11/2022	SUPER BOLSA PARA ESCOMBRO (mixta)	16 (Concedida S/D)	Federico Ajemlat	
527231	07/10/2022	BZ	12 (Concedida S/D)	TOYOTA JIDOSHA KABUSHIKI KAISHA (also trading as TOYOTA MOTOR CORPORATION)	94
527234	07/10/2022	LETSFIT (mixta)	41 (Concedida)	MASTEY S.A.	201
527237	07/11/2022	POKHARA HOME STORE ONLINE R (mixta)	35 (Concedida), 25 (Concedida) y 3 (Concedida)	JOSE CARDOZO	
527238	15/11/2022	TOO GOOD TO GO	43 (Concedida S/D), 42 (Concedida S/D), 41 (Concedida S/D), 35 (Concedida S/D), 32 (Concedida S/D), 31 (Concedida S/D), 30 (Concedida S/D), 29 (Concedida S/D) y 9 (Concedida S/D)	Too Good To Go ApS	144
527241	07/10/2022	JAFER SEGUROS (mixta)	36 (Concedida S/D)	Nestor Javier Ferraro Fabre	
527242	07/10/2022	ARTICO (mixta)	29 (Concedida)	DANILO CORDONE	144

N° Exp	Resolución	Marca	Clases	Titular	Ag.
527244	07/10/2022	ARTICO (mixta)	43 (Concedida)	DANILO CORDONE	144
527245	07/10/2022	VIBRA (mixta)	43 (Concedida S/D), 42 (Concedida S/D), 40 (Concedida S/D), 39 (Concedida S/D), 37 (Concedida S/D), 36 (Concedida S/D), 35 (Concedida S/D), 9 (Concedida S/D), 4 (Concedida S/D) y 1 (Concedida S/D)	VIBRA ENERGIA S.A.	144
527247	07/10/2022	BORCAM SISTEMAS INTEGRALES (mixta)	42 (Concedida S/D)	Diego Borba	
527249	07/10/2022	FLUIR EN FUSIÓN	41 (Concedida S/D)	Florencia Villaverde	
527257	07/10/2022	(figurativa)	5 (Concedida S/D)	Amgen Inc.	245
527258	07/10/2022	CUMPLO360 (mixta)	45 (Concedida)	BRODITEC S.A	212
527261	07/10/2022	ENTERSHOP	43 (Concedida), 35 (Concedida) y 9 (Concedida)	ALBERTO MARTIN SCASSO VOLONTE	
527264	17/10/2022	CRÉDITO SI (mixta)	35 (Concedida)	NALTILEX S A	220
527265	25/11/2022	CRÉDITO SI (mixta)	36 (Concedida S/D)	NALTILEX S A	220
527273	17/10/2022	LA MALETA ROJA (mixta)	35 (Concedida), 25 (Concedida) y 3 (Concedida)	Ummed Dinya Hoerneck	
527275	07/10/2022	TECNOLIGHT	24 (Concedida)	BABAT BURCATOVSKY, GREGORIO	189
527277	07/10/2022	LAPASIVA.UY	38 (Concedida) y 9 (Concedida S/D)	FLORIAN S.A.	189
527278	07/10/2022	THE DONUTS HOUSE (mixta)	43 (Concedida), 35 (Concedida) y 30 (Concedida)	DUGA, MARÍA FERNANDA	189
527281	07/10/2022	CANNEFF	5 (Concedida S/D) y	CB21 Pharma, s.r.o.	34

N° Exp	Resolución	Marca	Clases	Titular	Ag.
			3 (Concedida S/D)		
527294	17/10/2022	IN VITRO URUGUAY (mixta)	44 (Concedida)	In Vitro Uruguay SRL	194
527296	07/10/2022	MOLTOK	35 (Concedida)	Moltok s.a.	194
527301	07/10/2022	DIORSHOW ON SET BROW	3 (Concedida S/D)	PARFUMS CHRISTIAN DIOR	245
527303	28/10/2022	ESSENZA (mixta)	43 (Concedida), 35 (Concedida), 30 (Concedida S/D) y 29 (Concedida)	ODASUPED SRL	212
527305	17/10/2022	GC&A GRIECO CHAMPRET & ASOCIADOS (mixta)	42 (Concedida S/D), 41 (Concedida S/D) y 35 (Concedida S/D)	Instituto GCA SAS	
527309	12/10/2022	AGROVET MARKET (mixta)	35 (Concedida)	AGROVET MARKET S.A.	189
527310	12/10/2022	(figurativa)	5 (Concedida)	AGROVET MARKET S.A.	189
527311	12/10/2022	SINCROM	35 (Concedida)	MARTINEZ HELLBUSCH, MARCELO DANIEL	201
527313	12/10/2022	CUENTA JOVEN	36 (Concedida)	BANCO DE LA REPUBLICA ORIENTAL DEL URUGUAY	154
527325	24/10/2022	DEUTSCHE RÜCK (mixta)	36 (Concedida S/D)	Deutsche Rückversicherung Aktiengesellschaft	94
527327	17/10/2022	LA MEJOR (mixta)	35 (Concedida) y 25 (Concedida)	Victorio Giroldi Sosa	
527335	17/10/2022	(figurativa)	44 (Concedida S/D), 43 (Concedida S/D) y 41 (Concedida S/D)	Adventist Development and Relief Agency International	245
527339	17/10/2022	SPIRALINA	17 (Concedida S/D) y 6 (Concedida S/D)	Merlett Tecnoplastic S.P.A.	218
527343	17/10/2022	EVENTOS BARTORA	41 (Concedida)	BARTORA FERRARO GERARDO MILTON	179
527347	17/10/2022	EXP ASU (mixta)	5 (Concedida S/D) y 1 (Concedida S/D)	LABORATOIRES EXPANSCIENCE	219
527352	17/10/2022	CYBERRACERS (mixta)	28 (Concedida S/D)	MAY CHEONG TOY PRODUCTS FACTORY	181

N° Exp	Resolución	Marca	Clases	Titular	Ag.
				LIMITED	
527370	24/10/2022	PALISAD	25 (Concedida S/D), 18 (Concedida S/D) y 8 (Concedida S/D)	MATRIZE Handels-GmbH	201
527372	24/10/2022	MAGNOLIO CAMPUS (mixta)	41 (Concedida)	LA RULA PRODUCCIONES SRL	194
527375	24/10/2022	MTX (mixta)	25 (Concedida S/D), 22 (Concedida S/D), 18 (Concedida S/D), 12 (Concedida S/D) y 8 (Concedida S/D)	MATRIZE Handels-GmbH	201
527377	24/10/2022	GROSS (mixta)	25 (Concedida S/D), 18 (Concedida S/D) y 8 (Concedida S/D)	MATRIZE Handels-GmbH	201
527378	24/10/2022	KUALOX (mixta)	35 (Concedida), 8 (Concedida), 7 (Concedida) y 3 (Concedida)	Martin Leonardo Cox	94
527382	24/10/2022	UNIVERSAL SHIPPING AGENCY URUGUAY (mixta)	39 (Concedida) y 35 (Concedida)	UNIVERSAL SHIPPING AGENCY S.A.	216
527384	24/10/2022	UNIVERSAL SHIPPING AGENCY URUGUAY (mixta)	39 (Concedida) y 35 (Concedida)	UNIVERSAL SHIPPING AGENCY S.A.	216
527385	24/10/2022	ERNST & YOUNG	35 (Concedida S/D)	EYGN LIMITED	194
527386	24/10/2022	LA SOSTENIBLE (mixta)	24 (Concedida S/D), 21 (Concedida S/D) y 8 (Concedida S/D)	Vanessa Lucena Rodriguez Arévalo	
527387	24/10/2022	OVINOS URUGUAY	35 (Concedida) y 9 (Concedida)	Jorge Pablo Gonzalez Lopez	
527388	28/10/2022	FLS FREIGHT&LOGISTIC SERVICES (mixta)	39 (Concedida S/D) y 35 (Concedida)	FLS SRL	189
527389	28/10/2022	VEGAN SHOES MODA CONSCIENTE	25 (Concedida S/D)	DISTRIBUIDORA DEL POLO SAS	220

N° Exp	Resolución	Marca	Clases	Titular	Ag.
527391	24/10/2022	HAUSSER (mixta)	35 (Concedida), 12 (Concedida) y 7 (Concedida)	Bruno Hausser Grant	
527392	24/10/2022	ONIRICO ... DISEÑANDO EL LUGAR DE TUS SUEÑOS (mixta)	35 (Concedida)	LIZARRAGA GONZALEZ, ANDREA GABRIELA	201
527395	24/10/2022	EPIC FUTUREPROOF (mixta)	9 (Concedida S/D)	EPIC SYSTEMS Co., Ltd.	144
527396	24/10/2022	GRATISSIMA. ÁREAS VERDES ESTUDIO	42 (Concedida S/D) y 16 (Concedida S/D)	GIANCARLOS GEYMONAT SCHAFFNER	
527397	24/10/2022	CON VERONICA D´ANDREA	41 (Concedida) y 38 (Concedida)	VERONICA D´ANDREA LUCADAME	19
527398	24/10/2022	ACTIVA TV	38 (Concedida)	TAUROZZI NEGRI, CARLOS DIEGO	189
527399	24/10/2022	MAGFORCE INTERNATIONAL (mixta)	25 (Concedida) y 18 (Concedida)	CHANG, TENG-YAO	94
527400	11/10/2022	ONDA	43 (Concedida)	Francisco Urioste	
527401	11/10/2022	PRUDENCE BELLEUP	10 (Concedida S/D)	DKT Uruguay S.A.	94
527402	11/10/2022	PITIBUM (mixta)	35 (Concedida) y 28 (Concedida)	Paula Celina Soiza Ardid	
527403	15/11/2022	BHJ (mixta)	35 (Concedida S/D), 31 (Concedida S/D), 29 (Concedida S/D), 4 (Concedida S/D) y 1 (Concedida S/D)	BHJ A/S	192
527409	17/10/2022	FERBI (mixta)	37 (Concedida S/D) y 35 (Concedida S/D)	GMRA S.A.	94
527410	17/10/2022	FERBI (mixta)	37 (Concedida S/D) y 35 (Concedida S/D)	GMRA S.A.	94
527419	19/10/2022	NG PALETAS HELADAS ARTESANALES (mixta)	43 (Concedida) y 30 (Concedida)	Canciani Sarasola Nicolas Beethoven y Fugassa Peña Ana Laura Sociedad de Hecho	

N° Exp	Resolución	Marca	Clases	Titular	Ag.
527420	11/10/2022	ENRIVON	5 (Concedida S/D)	BASF SE	144
527422	14/11/2022	CALU CARRY ON & WOMAN BAGS (mixta)	18 (Concedida S/D)	Romero Arrau SpA	144
527424	12/10/2022	SPEEDSPRAY	7 (Concedida S/D)	Samsung Electronics Co., Ltd.	245
527425	19/10/2022	DUALSTORM (mixta)	7 (Concedida S/D)	Samsung Electronics Co., Ltd.	245
527426	19/10/2022	PARQUE INDUSTRIAL RUTA 5 TECNOLÓGICO Y LOGÍSTICO A MEMBER OF GRUPO RAS (mixta)	39 (Concedida), 37 (Concedida) y 36 (Concedida)	RUBEN AZAR SCARONE	118
527427	12/10/2022	BUBBLESTORM (mixta)	7 (Concedida S/D)	Samsung Electronics Co., Ltd.	245
527428	16/11/2022	VARIEDADES B (mixta)	31 (Concedida)	BARRACA JORGE WALTER ERRO S.A	34
527429	16/11/2022	I+D (mixta)	31 (Concedida)	BARRACA JORGE WALTER ERRO S.A.	34
527430	11/10/2022	DAME (mixta)	44 (Concedida S/D)	ACOMPÑANTES DESAFIO S.A.	
527431	25/10/2022	LA GRANJA HONEY	30 (Concedida S/D)	Jonathan Lavandeira	
527432	19/10/2022	FG CORTINAS DE ENROLLAR (mixta)	24 (Concedida S/D), 20 (Concedida S/D) y 19 (Concedida S/D)	Felipe Gambetta	
527433	24/10/2022	GRECO MAYORISTA	35 (Concedida S/D)	LEONARDO MARTIN MICHELENA GEORGIADIS	
527435	19/10/2022	LA VOZ DEL CAMPO	41 (Concedida) y 38 (Concedida)	MARTIN JESUS OLAVERRY LEMME	179
527442	12/10/2022	CELEREST (mixta)	10 (Concedida) y 5 (Concedida)	BIOPARK SCIENTIFIC S.A.	181
527444	21/11/2022	LA MÁS LINDA CENTRO ESTÉTICO INTEGRAL (mixta)	44 (Concedida S/D) y 3 (Concedida S/D)	MOIRA ALEJANDRA BRUN CABEZUDO	
527445	12/10/2022	FIND THE WAY (mixta)	25 (Concedida) y 8 (Concedida)	RAFAEL GOMENSORO ETCHEVERRY	194
527446	12/10/2022	DRX DURABOX (mixta)	12 (Concedida)	Franco José Yuale	220
527448	24/10/2022	FERIA MADRE DOMINICAL	41 (Concedida)	Ricardo Javier Cozzano Ferreira	144
527449	19/10/2022	COLECTIVO CULTURAL FERIA DE TRISTÁN NARVAJA	41 (Concedida)	Ricardo Javier Cozzano Ferreira	144

N° Exp	Resolución	Marca	Clases	Titular	Ag.
527453	11/10/2022	UMITEM	5 (Concedida)	MEGA LABS S.A.	144
527454	11/10/2022	KOLITISA	5 (Concedida)	MEGA LABS S.A.	144
527455	11/10/2022	ATRITAS	5 (Concedida)	MEGA LABS S.A.	144
527456	11/10/2022	GIBELA	5 (Concedida)	MEGA LABS S.A.	144
527460	11/10/2022	FICUS (mixta)	37 (Concedida) y 36 (Concedida)	VENTURA RENTALS S.A.S.	181
527461	11/10/2022	COSMOPOLITAN (mixta)	37 (Concedida) y 36 (Concedida)	VENTURA RENTALS S.A.S.	181
527462	19/10/2022	LA GRANJA COLONIA VALDENSE (mixta)	29 (Concedida)	GRANJA BRASSETTI S.R.L.	144
527465	11/10/2022	NÓRDICO (mixta)	36 (Concedida)	VENTURA RENTALS S.A.S.	181
527466	24/10/2022	COSTANERA VILLAGE (mixta)	37 (Concedida) y 36 (Concedida)	VENTURA RENTALS S.A.S.	181
527469	11/10/2022	EVOLV	10 (Concedida S/D)	Starkey Laboratories, Inc.	194
527470	12/10/2022	DUREVITY	5 (Concedida S/D)	ELANCO US INC.	194
527472	12/10/2022	TENGEN (mixta)	9 (Concedida S/D)	ZHEJIANG TENGEN ELECTRIC CO., LTD.	34
527473	17/10/2022	CARRASCO CAR SERVICE (mixta)	37 (Concedida)	CENAFIN S.A.	201
527474	12/10/2022	SOVERNA	1 (Concedida S/D)	Marrone Bio Innovations, Inc.	216
527475	12/10/2022	CANAFFECT	5 (Concedida S/D)	ELANCO US INC.	194
527476	12/10/2022	KOPEL SÁNCHEZ (mixta)	37 (Concedida) y 36 (Concedida)	Kopel Sanchez SRL	181
527480	12/10/2022	MARCUS&MARCUS	28 (Concedida), 25 (Concedida), 24 (Concedida), 21 (Concedida), 20 (Concedida), 10 (Concedida) y 8 (Concedida)	Gift Concept Products Limited	220
527482	12/10/2022	OCS ORGANIZACIÓN CANELONES (mixta)	36 (Concedida) y 35 (Concedida)	IRIS JUSTET	220
527483	12/10/2022	ALBA (mixta)	36 (Concedida)	INÉS FERNÁNDEZ	220

N° Exp	Resolución	Marca	Clases	Titular	Ag.
527487	12/10/2022	FUTURA RESIDENCIA S.A.S	43 (Concedida)	CESAR GUSTAVO MARTINEZ	
527490	12/10/2022	GO - GOTRACK (mixta)	39 (Concedida)	keider vargas	
527491	12/10/2022	CABAÑA EL TERRENO (mixta)	35 (Concedida) y 29 (Concedida)	VIRÉ AVONDET, RAMIRO DAMIÁN	201
527505	17/10/2022	GOSTRONG	32 (Concedida S/D) y 29 (Concedida S/D)	Société des Produits Nestlé S.A.	156
527506	19/10/2022	NARAKAN	43 (Concedida) y 41 (Concedida)	MARIANO IRIBARREN	194
527509	25/10/2022	LA DULZURA DE BEJAMIA LA DULZURA DE BEJAMIA (mixta)	35 (Concedida) y 30 (Concedida)	SERGIO FERNANDO TORRES BOVE	194
527512	17/10/2022	BARILLA DAL 1877 (mixta)	43 (Concedida S/D), 30 (Concedida S/D) y 29 (Concedida S/D)	Barilla G. e R. Fratelli - Società per Azioni	194
527516	19/10/2022	CHARTEALO	35 (Concedida)	FEDERICO ANDRÉSURETA CUADRADO; MARIA INES PRILASSNIG CUNHA y ALEJANDRO FABIÁN CIAVATTINI	163
527520	19/10/2022	PETROPLAS (mixta)	21 (Concedida)	PETROPLAS SRL	220
527522	24/10/2022	LALULA SLOW TOYS (mixta)	28 (Concedida S/D)	Natalia Jorcin	
527525	07/11/2022	GRECO AUTOSERVICE	35 (Concedida S/D)	LEONARDO MARTIN MICHELENA GEORGIADIS	
527526	25/10/2022	P K	17 (Concedida) y 2 (Concedida)	PELIART SZTERMAN, DIEGO MARCEL y PÍRIZ DOS SANTOS, DANIEL	189
527527	18/10/2022	MEJOR AMIGO ® (mixta)	31 (Concedida S/D)	Miguel Pacheco	
527528	28/10/2022	ADULTO MAYOR VITAL	16 (Concedida)	PIRRI GARGIULO MARIA ALEJANDRA Y PIRRI GARGIULO MARIA NOEL SOCIEDAD DE HECHO	
527540	25/10/2022	ITIMAT	11 (Concedida S/D)	MIROVAI S.A.	
527544	24/10/2022	SLOW (mixta)	21 (Concedida S/D)	BETTANIN S/A.	144
527545	19/10/2022	LANOSSI (mixta)	21 (Concedida S/D)	BETTANIN S/A.	144

N° Exp	Resolución	Marca	Clases	Titular	Ag.
527546	24/10/2022	LUXIMO	5 (Concedida S/D) y 1 (Concedida S/D)	BASF Agro B.V. Arnhem (NL), Zweigniederlassung Freienbach	144
527548	25/10/2022	TIENDAS OCULTAS	38 (Concedida) y 35 (Concedida)	LITERIX S.A.	144
527553	31/10/2022	ITEM (mixta)	3 (Concedida S/D)	Item Beauty, LLC	94
527554	31/10/2022	ITEM (mixta)	3 (Concedida S/D)	Item Beauty, LLC	94
527556	20/10/2022	GANCIA (mixta)	33 (Concedida S/D)	SPEED PUBLICIDAD S.A.C.I.F.	34
527558	21/11/2022	UTIL QUIMICA FACILITA SUA VIDA (mixta)	3 (Concedida)	UTIL QUIMICA INDUSTRIA E COMERCIO LTDA	34
527559	28/10/2022	O2 (mixta)	38 (Concedida S/D) y 9 (Concedida S/D)	O2 Worldwide Limited	216
527561	24/10/2022	REMITEX (mixta)	36 (Concedida) y 9 (Concedida)	BITEX URUGUAY SRL	34
527563	28/10/2022	BARRIO SAN NICOLÁS (mixta)	36 (Concedida)	DATYLCO S.A.	181
527564	25/10/2022	AGROCOPPER	5 (Concedida S/D)	Compañía Minera San Gerónimo	205
527565	25/10/2022	FERTICOPPER	1 (Concedida S/D)	Compañía Minera San Gerónimo	205
527566	28/10/2022	RTM	18 (Concedida S/D)	CIA HERING	212
527567	31/10/2022	RTM	25 (Concedida S/D)	CIA HERING	212
527568	28/10/2022	RTM	35 (Concedida S/D)	CIA HERING	212
527569	24/10/2022	SOFTIA	42 (Concedida S/D)	Pedro Ibarguren	
527570	24/10/2022	SANTA MAZZA (mixta)	43 (Concedida S/D)	Martin Alvarez	
527571	24/10/2022	STAYER	5 (Concedida S/D)	Miguel Pacheco	
527572	25/10/2022	BINGO BURGER; LOCAL & REAL (mixta)	43 (Concedida S/D)	Nicolás De Marco	
527573	25/10/2022	READY TO MOVE	18 (Concedida S/D)	CIA HERING	212
527574	07/11/2022	CAMEDUR I.A.M.P.P. (mixta)	44 (Concedida)	CAMEDUR IAMPP	192
527575	28/10/2022	READY TO MOVE	25 (Concedida S/D)	CIA HERING	212
527576	16/11/2022	READY TO MOVE	35 (Concedida S/D)	CIA HERING	212
527582	24/10/2022	CAREFREE (mixta)	5 (Concedida S/D)	JOHNSON & JOHNSON	194
527583	24/10/2022	FEEL ESCUELA DE MÚSICA (mixta)	41 (Concedida S/D)	Carolina Abella	

N° Exp	Resolución	Marca	Clases	Titular	Ag.
527584	28/10/2022	D GGS (mixta)	44 (Concedida)	Walter Rodriguez	
527585	11/11/2022	ROYAL PRESTIGE	21 (Concedida), 11 (Concedida), 8 (Concedida) y 7 (Concedida)	Hy Cite Enterprises, LLC	201
527586	28/10/2022	(figurativa)	21 (Concedida), 11 (Concedida), 8 (Concedida) y 7 (Concedida)	Hy Cite Enterprises, LLC	201
527587	11/11/2022	EXPERT FILLER CELLULAR (mixta)	3 (Concedida S/D)	Beiersdorf AG	136
527588	28/10/2022	NBHA NATIONAL BARREL HORSE URUGUAY (mixta)	41 (Concedida) y 25 (Concedida)	Federico Delgado Gutiérrez	220
527589	07/11/2022	EXPERT FILLER CELLULAR (mixta)	3 (Concedida S/D)	Beiersdorf AG	136
527604	24/10/2022	MERIDIONAL REPRESENTACIONES (mixta)	39 (Concedida)	ANTONIO WALTER GALLICCHIO	165
527608	28/10/2022	BLACKBERRY IVY	42 (Concedida S/D)	BlackBerry Limited	34
527611	28/10/2022	IVY	42 (Concedida S/D)	BlackBerry Limited	34
527612	17/10/2022	FILTEK (mixta)	10 (Concedida S/D)	3M Company	212
527613	24/10/2022	SPRITE (mixta)	32 (Concedida)	THE COCA-COLA COMPANY	94
527632	17/10/2022	PINTASIL	2 (Concedida S/D)	carlos hoffmann	
527635	24/10/2022	FUTURE CHICK'N	29 (Concedida S/D)	Fazenda Futuro Produtos Alimenticios SA	194
527636	24/10/2022	FUTURE MEATBALL	29 (Concedida S/D)	Fazenda Futuro Produtos Alimenticios SA	194
527637	24/10/2022	FUTURE SAUSAGE	29 (Concedida S/D)	Fazenda Futuro Produtos Alimenticios SA	194
527638	24/10/2022	FUTURE MINCE	29 (Concedida S/D)	Fazenda Futuro Produtos Alimenticios SA	194
527643	28/10/2022	CIMIENTOS CONSTRUYAMOS DESDE LA EDUCACIÓN (mixta)	41 (Concedida)	FUNDACION CIMIENTOS	94
527647	17/10/2022	SAVENA	1 (Concedida S/D)	FITOQUIMICA S.A.	94
527648	17/10/2022	SAVENA	5 (Concedida S/D)	FITOQUIMICA S.A.	94
527649	24/10/2022	SECURED BY KNOX	42 (Concedida S/D) y 9 (Concedida S/D)	Samsung Electronics Co., Ltd.	194
527650	17/10/2022	BREIT	36 (Concedida)	Blackstone TM L.L.C.	194

N° Exp	Resolución	Marca	Clases	Titular	Ag.
527651	14/11/2022	FIDELITY MARKETING (mixta)	35 (Concedida S/D)	FIDELITY MARKETING GROUP S. DE R.L. DE C.V.	194
527652	24/10/2022	MCC MOVIMIENTO CORPORAL CONSCIENTE (mixta)	41 (Concedida S/D)	Natalia Pulgar	
527653	17/10/2022	BABYSEC	5 (Concedida)	CMPC TISSUE S.A.	221
527655	17/10/2022	HOGAX	36 (Concedida)	DIEGO SUAREZ GIANELLI	144
527656	24/10/2022	MEAT ME BOUTIQUE DE CARNES (mixta)	35 (Concedida) y 29 (Concedida S/D)	MEAT YOU S.A.S.	194
527657	24/10/2022	ELITE (mixta)	16 (Concedida)	CMPC TISSUE S.A.	221
527659	24/10/2022	TONY´S (mixta)	43 (Concedida S/D) y 30 (Concedida S/D)	ACC S.A.S.	220
527660	24/10/2022	MI CARE (mixta)	9 (Concedida S/D)	XIAOMI INC.	34
527661	28/10/2022	MI CARE (mixta)	35 (Concedida S/D)	XIAOMI INC.	34
527663	24/10/2022	MI CARE (mixta)	36 (Concedida S/D)	XIAOMI INC.	34
527664	24/10/2022	MI CARE (mixta)	37 (Concedida S/D)	XIAOMI INC.	34
527667	24/10/2022	CLEVER LEAVES (mixta)	1 (Concedida S/D)	Eagle Canada Holdings, Inc.	212
527668	24/10/2022	CLEVER LEAVES (mixta)	2 (Concedida S/D)	Eagle Canada Holdings, Inc.	212
527670	24/10/2022	CLEVER LEAVES (mixta)	5 (Concedida S/D)	Eagle Canada Holdings, Inc.	212
527671	24/10/2022	CLEVER LEAVES (mixta)	29 (Concedida S/D)	Eagle Canada Holdings, Inc.	212
527672	24/10/2022	CLEVER LEAVES (mixta)	30 (Concedida S/D)	Eagle Canada Holdings, Inc.	212
527675	24/10/2022	CLEVER LEAVES (mixta)	32 (Concedida S/D)	Eagle Canada Holdings, Inc.	212
527676	24/10/2022	CLEVER LEAVES (mixta)	34 (Concedida S/D)	Eagle Canada Holdings, Inc.	212
527678	24/10/2022	CLEVER LEAVES (mixta)	42 (Concedida S/D)	Eagle Canada Holdings, Inc.	212
527679	24/10/2022	CLEVER LEAVES (mixta)	44 (Concedida S/D)	Eagle Canada Holdings, Inc.	212
527680	24/10/2022	TRES INDIAS	32 (Concedida)	juan marcelo hernandez	
527685	24/10/2022	PADME MATS ECOLÓGICOS (mixta)	27 (Concedida S/D)	IORELLA ALEJANDRA PASARELLO CONLAZO	
527687	24/10/2022	LIMOL 420	32 (Concedida)	PABEWIL SOCIEDAD ANÓNIMA	189
527710	25/10/2022	BRUNCHIES	29 (Concedida)	CATTIVELLI HNOS. S.A.	129

N° Exp	Resolución	Marca	Clases	Titular	Ag.
527713	25/10/2022	CHOCHA Y NENA	43 (Concedida)	VIRÉ AVONDET, RAMIRO DAMIÁN	201
527714	24/10/2022	VITA BELLA (mixta)	25 (Concedida)	CINTIA ROMINA BELLA	219
527716	24/10/2022	MODAR	1 (Concedida S/D)	INEOS COMPOSITES IP, LLC	194
527718	24/10/2022	ARTENGO	28 (Concedida), 25 (Concedida), 24 (Concedida), 18 (Concedida) y 9 (Concedida)	PROJETCLUB SA	194
527719	24/10/2022	FORCLAZ	28 (Concedida), 25 (Concedida), 22 (Concedida), 21 (Concedida), 20 (Concedida), 18 (Concedida), 11 (Concedida), 9 (Concedida), 5 (Concedida) y 3 (Concedida)	DECATHLON SE	194
527720	24/10/2022	INESIS	28 (Concedida), 25 (Concedida) y 18 (Concedida)	DECATHLON SE	194
527721	24/10/2022	ITIWIT	28 (Concedida), 25 (Concedida), 21 (Concedida), 18 (Concedida), 12 (Concedida) y 9 (Concedida)	PROJETCLUB SA	194
527723	24/10/2022	KALENJI	28 (Concedida), 25 (Concedida), 21 (Concedida), 18 (Concedida), 14 (Concedida)	DECATHLON SE	194

N° Exp	Resolución	Marca	Clases	Titular	Ag.
			(Concedida) y 9 (Concedida)		
527724	24/10/2022	KIPRUN	28 (Concedida), 25 (Concedida), 21 (Concedida), 18 (Concedida), 14 (Concedida), 11 (Concedida) y 9 (Concedida)	DECATHLON SE	194
527725	24/10/2022	NABAIJI	28 (Concedida), 25 (Concedida), 24 (Concedida), 18 (Concedida), 14 (Concedida) y 9 (Concedida)	PROJETCLUB SA	194
527726	24/10/2022	MÓBEL (mixta)	35 (Concedida)	MOBELUY SAS	181
527727	24/10/2022	KIPSTA	28 (Concedida), 25 (Concedida), 18 (Concedida) y 9 (Concedida)	DECATHLON SE	194
527729	24/10/2022	OLAIAN	28 (Concedida), 25 (Concedida), 18 (Concedida) y 9 (Concedida)	PROJETCLUB SA	194
527730	24/10/2022	OFFLOAD	28 (Concedida), 25 (Concedida), 18 (Concedida) y 9 (Concedida)	DECATHLON SE	194
527731	24/10/2022	GRAFFITI (mixta)	9 (Concedida)	Ivan Vegovich	
527732	24/10/2022	OUTSHOCK	28 (Concedida), 25 (Concedida), 18	PROJETCLUB SA	194

N° Exp	Resolución	Marca	Clases	Titular	Ag.
			(Concedida) y 9 (Concedida)		
527734	24/10/2022	OXELO	28 (Concedida), 25 (Concedida), 18 (Concedida) y 9 (Concedida)	PROJETCLUB SA	194
527735	24/10/2022	SUBEA	28 (Concedida), 25 (Concedida), 18 (Concedida), 11 (Concedida) y 9 (Concedida)	DECATHLON SE	194
527736	24/10/2022	TARMAK	28 (Concedida), 25 (Concedida) y 18 (Concedida)	PROJETCLUB SA	194
527737	24/10/2022	TRIBAN	28 (Concedida), 25 (Concedida), 21 (Concedida), 18 (Concedida), 12 (Concedida), 11 (Concedida), 9 (Concedida) y 8 (Concedida)	DECATHLON SE	194
527738	24/10/2022	TRIBORD	28 (Concedida), 25 (Concedida), 24 (Concedida), 22 (Concedida), 18 (Concedida), 12 (Concedida) y 9 (Concedida)	DECATHLON SE	194
527739	24/10/2022	WED'ZE	28 (Concedida), 25 (Concedida), 18	PROJETCLUB SA	194

N° Exp	Resolución	Marca	Clases	Titular	Ag.
			(Concedida) y 9 (Concedida)		
527740	24/10/2022	VAN RYSEL	28 (Concedida), 25 (Concedida), 21 (Concedida), 18 (Concedida), 12 (Concedida), 11 (Concedida), 9 (Concedida) y 8 (Concedida)	DECATHLON SE	194
527741	24/10/2022	ROCKRIDER	28 (Concedida), 25 (Concedida), 21 (Concedida), 18 (Concedida), 11 (Concedida), 9 (Concedida) y 8 (Concedida)	DECATHLON SE	194
527744	24/10/2022	JOKR	43 (Concedida S/D), 42 (Concedida S/D), 39 (Concedida S/D), 35 (Concedida S/D) y 9 (Concedida S/D)	JOKR S.à.r.l.	34
527748	24/10/2022	WATERLOO	32 (Concedida S/D)	Waterloo Sparkling Water Corp.	212
527750	24/10/2022	AV ANDAMOS VOLANDO.COM (mixta)	43 (Concedida) y 39 (Concedida)	ANDAMOS S.A.	212
527751	31/10/2022	SOLEIL URUCUM (mixta)	3 (Concedida)	DENISSE NUNES NICOLA	212
527752	24/10/2022	SALVIARE	5 (Concedida S/D)	LUMINOVA PHARMA CORPORATION GmbH	212
527754	24/10/2022	NORADOLET	5 (Concedida S/D)	LUMINOVA PHARMA CORPORATION GmbH	212
527755	24/10/2022	SERADOM	5 (Concedida S/D)	LUMINOVA PHARMA CORPORATION GmbH	212
527756	24/10/2022	AZELAFLU	5 (Concedida S/D)	LUMINOVA PHARMA CORPORATION GmbH	212
527758	24/10/2022	MAC FIESTAS (mixta)	35 (Concedida)	Dora Gauthier	212

N° Exp	Resolución	Marca	Clases	Titular	Ag.
527759	24/10/2022	DREAMS OF POWER (mixta)	45 (Concedida S/D)	Georgina Batista	
527761	15/11/2022	PASTURE GENETICS URUGUAY	31 (Concedida)	Guillermo CUBAS NORANDO	
527762	25/10/2022	EL DÍA DEL ALFAJOR	35 (Concedida)	ZUNINO SATRAGNI, AGUSTIN	189
527764	25/10/2022	WORLD TRADING	35 (Concedida)	Gonzalo Troche	
527767	25/10/2022	DECO (mixta)	9 (Concedida S/D)	TP-LINK CORPORATION LIMITED	179
527768	24/10/2022	HOMECARE (mixta)	9 (Concedida S/D)	TP-LINK CORPORATION LIMITED	179
527769	24/10/2022	OMADA (mixta)	9 (Concedida S/D)	TP-LINK CORPORATION LIMITED	179
527770	24/10/2022	TAPO	11 (Concedida S/D) y 9 (Concedida S/D)	TP-LINK CORPORATION LIMITED	179
527772	24/10/2022	LA CROISSANTERIA (mixta)	43 (Concedida) y 30 (Concedida)	CECILIA AGUIRRE	
527773	24/10/2022	NOBUTAKI	18 (Concedida S/D)	Federico Schlimovich	234
527775	24/10/2022	GOOD FOR YOU (mixta)	44 (Concedida) y 3 (Concedida)	Good For You SAS	144
527778	24/10/2022	KERTESIN	5 (Concedida S/D)	VIRBAC LATAM SpA	201
527780	25/10/2022	CRYO SYSTEMS (mixta)	11 (Concedida S/D)	Guangzhou Cryo Systems Refrigeration Equipment Co.,Ltd	201
527784	24/10/2022	LL LINGLONG (mixta)	12 (Concedida S/D)	SHANDONG LINGLONG TYRE CO., LTD.	201
527785	25/10/2022	VINI (mixta)	35 (Concedida S/D)	Vini Industrial Co., Ltd.	34
527787	07/11/2022	FUELTECH (mixta)	35 (Concedida), 12 (Concedida) y 9 (Concedida)	FUELTECH LTDA.	34
527788	24/10/2022	SUPRASUR (mixta)	35 (Concedida)	SUPRASUR S.A.	181
527789	07/11/2022	FTE ELECTRIC POWER (mixta)	12 (Concedida) y 9 (Concedida)	FUELTECH LTDA.	34
527791	25/10/2022	UNITY	42 (Concedida S/D) y 9 (Concedida S/D)	Alcon Inc.	194
527792	24/10/2022	VILLAVICENCIO	32 (Concedida)	AGUAS DANONE DE ARGENTINA S.A.	245
527797	31/10/2022	PEPAS ALEMANAS (mixta)	30 (Concedida) y 29 (Concedida)	PRODUCTOS TRIO S.A.	245
527798	15/11/2022	DITERAN ACTIVE	31 (Concedida), 5	Mundo Surcos S.A.	220

N° Exp	Resolución	Marca	Clases	Titular	Ag.
			(Concedida) y 1 (Concedida)		
527801	24/10/2022	VISIÓN LABORAL (mixta)	41 (Concedida)	Nelson Larrañaga	218
527802	24/10/2022	DIHOLA (mixta)	42 (Concedida) y 9 (Concedida)	CURBELO PEREZ MARCOS GONZALO Y GOMEZ JUAN BAUTISTA SOCIEDAD DE HECHO	
527807	24/10/2022	VECATOY'S EL MUNDO DEL JUGUETE (mixta)	35 (Concedida)	CARLA GRAFFIGNA	
527808	24/10/2022	CARIPRAL	5 (Concedida)	BALIARDA S.A.	201
527810	24/10/2022	SIAGLIX	5 (Concedida)	BALIARDA S.A.	201
527811	24/10/2022	ASEPIX	5 (Concedida S/D)	BALIARDA S.A.	201
527812	24/10/2022	DAPAX	5 (Concedida)	BALIARDA S.A.	201
527814	24/10/2022	TELICAR	5 (Concedida)	BALIARDA S.A.	201
527815	24/10/2022	RONDINA (mixta)	25 (Concedida)	Grupo Internacional Mercosur Sociedad Anónima	
527817	24/10/2022	RND SPORT (mixta)	25 (Concedida)	Grupo Internacional Mercosur Sociedad Anónima	
527818	24/10/2022	VIVIR (mixta)	41 (Concedida), 38 (Concedida) y 35 (Concedida)	SOCIEDAD TELEVISORA LARRANAGA S.A. y Mueca Films SRL	220
527819	04/11/2022	SAMUD	30 (Concedida)	Daniel Alonzo	
527827	24/10/2022	ON CAPACITACIONES (mixta)	41 (Concedida)	Federico Agustín Cerón Barrios	
527829	24/10/2022	DOÑA CHIPA (mixta)	43 (Concedida) y 30 (Concedida)	GRUPO CORTEZA S.R.L.	189
527830	04/11/2022	ESPACIO ZEN (mixta)	44 (Concedida)	GREAT VICTORIA CORP.	144
527831	24/10/2022	VOICE OF COLOUR	42 (Concedida S/D), 16 (Concedida S/D), 9 (Concedida S/D) y 2 (Concedida S/D)	PPG ARCHITECTURAL FINISHES, INC.	144
527832	21/11/2022	WINGS COSMETICS (mixta)	35 (Concedida) y 3 (Concedida)	BASSI, RAÚL y CAPLAN, MAURICIO	189
527836	28/10/2022	(figurativa)	25 (Concedida S/D) y 18 (Concedida)	Ciro Paone S.p.A.	219

N° Exp	Resolución	Marca	Clases	Titular	Ag.
			S/D)		
527837	28/10/2022	A.S.U.S. ANNUAL SUPPORT & UPDATE SERVICE (mixta)	9 (Concedida)	NALTILEX S A	220
527838	21/11/2022	A.S.U.S. ANNUAL SUPPORT & UPDATE SERVICE (mixta)	39 (Concedida)	NALTILEX S A	220
527840	28/10/2022	OESTROGEL	5 (Concedida S/D)	BESINS HEALTHCARE LUXEMBOURG S.A.R.L.	165
527846	11/11/2022	LUZMILIBROS (mixta)	41 (Concedida S/D) y 16 (Concedida S/D)	ZAFIRO BAY SAS	220
527847	28/10/2022	INMOBILIARIA ÉXITO (mixta)	36 (Concedida S/D)	ROMERO FAGUAGA, MARIANELA	34
527849	11/11/2022	AMBIFY (mixta)	42 (Concedida S/D), 35 (Concedida S/D) y 9 (Concedida S/D)	AMBIPAR ENVIRONMENTAL SOLUTIONS - SOLUÇÕES AMBIENTAIS LTDA.	34
527852	28/10/2022	PUBLIBOLSA (mixta)	35 (Concedida)	ADRIANA BENITEZ MUNDO y MARISA ALEGRE TELLERÍA	
527858	28/10/2022	UNPLASTIFY	41 (Concedida S/D)	Unplastify S.R.L.	181
527859	28/10/2022	FERRERO ROCHER (mixta)	30 (Concedida S/D)	FERRERO S.P.A.	212
527860	28/10/2022	AGRANEL (mixta)	3 (Concedida S/D)	LABORIOT SAS	
527861	28/10/2022	HALVETIC	5 (Concedida S/D) y 1 (Concedida S/D)	CIECH Sarzyna S.A.	212
527862	28/10/2022	MUJERES CONSTRUCTORAS (mixta)	37 (Concedida S/D)	MUJERES CONSTRUCTORAS SAS	
527863	03/11/2022	MODISTA EN URUGUAY	25 (Concedida)	Joseline Pereira	
527865	14/11/2022	MUEBLES EXPRESS (mixta)	20 (Concedida S/D)	WELAMAN S.A.	189
527866	03/11/2022	TIMI A TENCENT GAMES STUDIO (mixta)	42 (Concedida S/D), 41 (Concedida S/D) y 9 (Concedida S/D)	TENCENT HOLDINGS LIMITED	144
527867	11/11/2022	CESANA CENTRO SALUD NATURAL (mixta)	44 (Concedida S/D)	Jose Walter Bonvin Chaves	
527868	28/10/2022	LITHIC	42 (Concedida S/D), 36 (Concedida S/D)	Pay With Privacy, Inc.	144

N° Exp	Resolución	Marca	Clases	Titular	Ag.
			y 9 (Concedida S/D)		
527869	04/11/2022	PROMEL SMART IDEAS (mixta)	28 (Concedida S/D) y 21 (Concedida S/D)	Rodrigo Melgar	
527872	03/11/2022	DERMADOCTOR	35 (Concedida S/D) y 3 (Concedida S/D)	Dermadoctor LLC	144
527874	04/11/2022	ROCKLANDER (mixta)	9 (Concedida S/D)	YAN, QI	34
527875	23/11/2022	RICCIARDI JOYAS (mixta)	36 (Concedida), 35 (Concedida S/D), 20 (Concedida), 14 (Concedida S/D) y 9 (Concedida)	ALEJANDRA BENZADON	163
527876	04/11/2022	LA FLEUR GREENPACHA RITUALS & WELLNESS (mixta)	3 (Concedida)	EVOLOVE LLC	34
527877	04/11/2022	GREENPACHA (mixta)	25 (Concedida) y 18 (Concedida)	EVOLOVE LLC	34
527878	04/11/2022	ANTONIAZZI	36 (Concedida), 35 (Concedida), 20 (Concedida), 14 (Concedida) y 9 (Concedida)	BRIAN BENZADON	163
527879	04/11/2022	MESMERIZE FLAME	3 (Concedida S/D)	AVON PRODUCTS, INC.	194
527881	04/11/2022	ANTONIAZZI CHIAPPE	36 (Concedida), 35 (Concedida), 20 (Concedida), 14 (Concedida) y 9 (Concedida)	BRIAN BENZADON	163
527882	04/11/2022	WILD COUNTRY RUSH	3 (Concedida S/D)	AVON PRODUCTS, INC.	194
527883	04/11/2022	FAR AWAY SPLENDORIA	3 (Concedida S/D)	AVON PRODUCTS, INC.	194
527885	04/11/2022	SEGNO	3 (Concedida S/D)	AVON PRODUCTS, INC.	194
527886	11/11/2022	FREE SHIPPING DAY ECOMSUR	38 (Concedida S/D),	Ecomsur Holding S.A.	144

N° Exp	Resolución	Marca	Clases	Titular	Ag.
		(mixta)	36 (Concedida S/D) y 35 (Concedida S/D)		
527887	04/11/2022	SEGNO IMPACT	3 (Concedida S/D)	AVON PRODUCTS, INC.	194
527888	11/11/2022	DAVINCI TRUSTED PARTNER (mixta)	36 (Concedida)	DV Trusted Partners S.A.	194
527890	04/11/2022	RADIO PLAY	38 (Concedida) y 35 (Concedida)	ALBERTO MARTIN SCASSO VOLONTE	
527895	04/11/2022	TATÚ (mixta)	9 (Concedida)	Jorge Pastorino y Asociados Ltda.	101
527898	11/11/2022	NBN LIVING COLÁGENO HIDROLIZADO MAX (mixta)	5 (Concedida S/D)	OSCAR HUMBERTO HERNANDEZ GARCÍA	212
527899	04/11/2022	LONCOPHYLL (mixta)	5 (Concedida S/D)	OSCAR HUMBERTO HERNANDEZ GARCÍA	212
527901	15/11/2022	TANGO BAR (mixta)	43 (Concedida S/D)	TANGO BAR SAS	212
527902	28/10/2022	CONTROL KILOS ¡APRENDER A COMER! (mixta)	44 (Concedida) y 41 (Concedida)	DANIEL KLIMAN	212
527904	24/10/2022	(figurativa)	35 (Concedida S/D) y 3 (Concedida S/D)	Dermadoctor LLC	144
527908	28/10/2022	LA TRIGUEÑA QUERIDA MARÍA M (mixta)	30 (Concedida)	P. R. LIMITADA	189
527909	04/11/2022	LA TRIGUEÑA ABUELA MARÍA (mixta)	30 (Concedida)	P. R. LIMITADA	189
527913	28/10/2022	HUGGIES MAX CLEAN	3 (Concedida S/D)	Kimberly-Clark Worldwide, Inc.	201
527921	28/10/2022	UMAKA (mixta)	25 (Concedida) y 18 (Concedida)	Maria Carolina De Cunto	
527925	28/10/2022	CHENDRA (mixta)	25 (Concedida) y 18 (Concedida)	Maria Carolina De Cunto	
527928	04/11/2022	NATURPLUS (mixta)	40 (Concedida S/D)	Ernesto Codina	
527934	31/10/2022	AGORA	30 (Concedida) y 29 (Concedida)	FERNILAND S.A.	201
527935	04/11/2022	MERCADO DISEGNO (mixta)	43 (Concedida) y 41 (Concedida)	DECOSOL S.A.	201

N° Exp	Resolución	Marca	Clases	Titular	Ag.
527938	31/10/2022	PAGLIFLOZ	5 (Concedida)	URUFARMA S.A.	34
527946	31/10/2022	JACK DANIEL'S	25 (Concedida S/D)	Jack Daniel's Properties, Inc.	192
527947	04/11/2022	TURISTA ROYAL (mixta)	28 (Concedida)	MOSCA HNOS. S.A.	192
527949	15/11/2022	NETAGRO (mixta)	36 (Concedida) y 35 (Concedida)	EDELFOR S.A.	192
527951	04/11/2022	MIARROZ ARROZ BLANCO INDUSTRIA URUGUAYA 8 TIEMPO DE COCCIÓN GRANO LARGO FINO CONT. NETO 1 KG. (mixta)	30 (Concedida S/D)	S.A. MOLINOS ARROCEROS NACIONALES	192
527953	04/11/2022	TAREUS (mixta)	9 (Concedida)	SERGIO ROBERTO PODESTA CARRATO	192
527955	11/11/2022	OBRADOR	41 (Concedida)	INFANZÓN ROSAS, NICOLÁS ISAAC	189
527966	04/11/2022	TVS RONIN (mixta)	12 (Concedida S/D)	SUNDARAM-CLAYTON LIMITED	94
527968	11/11/2022	CPE CONOCER PARA TRANSFORMAR (mixta)	41 (Concedida)	Daniela Jaureguiberry	
527970	14/11/2022	SUSTEON	5 (Concedida S/D)	BASF SE	144
527971	14/11/2022	NVL – THE DNA OF SHIPBUILDING	42 (Concedida S/D), 41 (Concedida S/D), 37 (Concedida S/D) y 12 (Concedida S/D)	NVL B.V. & Co. KG	144
527972	14/11/2022	CALORFLAT	11 (Concedida S/D)	MENDOCLIMA S.A.	220
527973	14/11/2022	TANGUS	29 (Concedida)	Ganadera Sur SRL	194
527974	14/11/2022	SUNITER TUTEUR	5 (Concedida S/D)	TUTEUR S.A.C.I.F.I.A.	201
527975	14/11/2022	ESTETICAN (mixta)	44 (Concedida), 35 (Concedida) y 18 (Concedida)	CATALDI ROSSELLO, SILVANA INES	194
527976	14/11/2022	SORJAN	25 (Concedida S/D)	Jannet Heredia	
527978	14/11/2022	MBC (mixta)	32 (Concedida), 30 (Concedida) y 29 (Concedida)	Urucompany S.A.	172
527982	14/11/2022	SNOW BABY (mixta)	3 (Concedida S/D)	R2M DO BRASIL INDUSTRIA DE	34

N° Exp	Resolución	Marca	Clases	Titular	Ag.
				COSMÉTICOS LTDA.	
527988	15/11/2022	SEMBRANDO (mixta)	45 (Concedida) y 41 (Concedida)	Presidencia de la República	
527990	21/11/2022	PROGRAMA SEMBRANDO EMPRENDEDORES	45 (Concedida), 41 (Concedida) y 35 (Concedida)	Presidencia de la República	
527991	14/11/2022	LÉNERGY (mixta)	25 (Concedida)	ABILER S.A.	101
527992	14/11/2022	(figurativa)	25 (Concedida)	Faniliat S.A.	101
527994	21/11/2022	PURE WELLNESS (mixta)	32 (Concedida), 30 (Concedida), 29 (Concedida) y 5 (Concedida S/D)	FARMCITY S.A.	245
527995	21/11/2022	PURE WELLNESS	32 (Concedida), 30 (Concedida), 29 (Concedida) y 5 (Concedida S/D)	FARMCITY S.A.	245
527996	21/11/2022	LEARN INC (mixta)	41 (Concedida)	Marco Moscardi y María Mercedes Remedi Correa	181
528000	03/11/2022	MENTALIUM MAKING EEG AFFORDABLE (mixta)	35 (Concedida) y 10 (Concedida)	MENTALIUM S.A.S.	189
528003	24/10/2022	BETRIOL	5 (Concedida) y 3 (Concedida)	LABORATORIOS ANDROMACO S.A.I.C.I.	144
528004	24/10/2022	VOYAH (mixta)	37 (Concedida) y 12 (Concedida)	DONGFENG MOTOR CORPORATION	201
528012	15/11/2022	NEXT FEED (mixta)	31 (Concedida)	Compañía de Alimentos y Cereales S.A.	144
528013	24/10/2022	CENTER APPS (mixta)	38 (Concedida) y 35 (Concedida)	SERCOTEL S.A. DE C.V.	181
528014	24/10/2022	SLS	36 (Concedida S/D)	SBE HOTEL LICENSING, LLC	144
528017	24/10/2022	IBERIA	21 (Concedida)	INDUSTRIAS IBERIA S.A.	219
528018	24/10/2022	GENNUINE (mixta)	5 (Concedida)	Laret SAS	101
528022	24/10/2022	U UNINUTRA (mixta)	5 (Concedida S/D)	LUMINOVA PHARMA CORPORATION GmbH	212

N° Exp	Resolución	Marca	Clases	Titular	Ag.
528023	14/11/2022	AURA	10 (Concedida S/D)	3M Company	212
528024	14/11/2022	1860	10 (Concedida S/D) y 9 (Concedida S/D)	3M Company	212
528025	14/11/2022	P TU PLAN (mixta)	36 (Concedida)	MAIORANO & CIA. S.B. S.A.	201
528026	28/10/2022	SUPER BARATO (mixta)	35 (Concedida)	Sonia González	
528027	14/11/2022	35 SUR (mixta)	41 (Concedida S/D)	Aníbal Patricio Bresque Delmonte	
528028	28/10/2022	SU SOMOS URUGUAY (mixta)	41 (Concedida), 35 (Concedida) y 16 (Concedida)	MARIO LEV BURCIKUS	219
528031	28/10/2022	MODERNA	42 (Concedida S/D), 5 (Concedida S/D) y 1 (Concedida S/D)	ModernaTX, Inc. (a corporation of Delaware, U.S.A.)	34
528042	03/11/2022	CORONA SUNBREW	32 (Concedida S/D)	Cervecería Modelo de México, S. de R.L. de C.V.	144
528043	28/10/2022	VOCCARE (mixta)	38 (Concedida S/D) y 35 (Concedida S/D)	Inversiones y Capitales American Assist, LLC	201
528044	28/10/2022	LAS ZAPAS	35 (Concedida)	JEROME LIMITADA	189
528045	28/10/2022	CASAFORTE URUGUAY ARQUITECTURA ECO SUSTENTABLE (mixta)	37 (Concedida), 35 (Concedida) y 19 (Concedida)	CASAFORTE URUGUAY S.A.S.	34
528046	15/11/2022	UMI PET FOOD	31 (Concedida S/D)	LAOR S.A.	34
528047	28/10/2022	A SIGN OF LOVE	43 (Concedida S/D), 30 (Concedida S/D) y 29 (Concedida S/D)	Barilla G. e R. Fratelli - Società per Azioni	194
528048	23/11/2022	PURASANGRE LA INDUSTRIA DEL TURF (mixta)	38 (Concedida) y 16 (Concedida)	L.H IMPORTACIONES S.A.S.	201
528049	28/10/2022	CASA PERFUM LLUM (mixta)	4 (Concedida S/D)	Melina Tamara Solari	212
528052	28/10/2022	CASA PERFUM LLUM (mixta)	35 (Concedida S/D)	Melina Tamara Solari	212
528053	28/10/2022	CASA PERFUM LLUM (mixta)	3 (Concedida S/D)	Melina Tamara Solari	212
528057	14/11/2022	ALMA FUERTE (mixta)	37 (Concedida S/D)	Francisco Di Salvo	

N° Exp	Resolución	Marca	Clases	Titular	Ag.
			y 12 (Concedida S/D)		
528060	28/10/2022	LEGIÓN (mixta)	35 (Concedida)	CRISTINA ELIZABETH SANCHEZ DE GOLDARACENA	
528067	28/10/2022	LILÁS (mixta)	25 (Concedida S/D) y 18 (Concedida S/D)	INVERSIONES AMIGU CHILE LIMITADA	220
528068	28/10/2022	FABE (mixta)	38 (Concedida S/D)	FALABELLA S.A.	181
528069	28/10/2022	FABE (mixta)	38 (Concedida S/D)	FALABELLA S.A.	181
528070	28/10/2022	(figurativa)	38 (Concedida S/D)	FALABELLA S.A.	181
528073	28/10/2022	OPINEL (mixta)	8 (Concedida S/D)	OPINEL SAS	201
528075	28/10/2022	HEMOQUIC	5 (Concedida S/D)	NIPRO CORPORATION	94
528077	03/11/2022	ORIUNDO	43 (Concedida)	PDM SAS	
528084	03/11/2022	RESERVA (mixta)	25 (Concedida)	QBX COMERCIAL IMPORTAÇÃO E EXPORTAÇÃO DE MERCADORIAS EM GERAL EIRELI	34
528085	03/11/2022	ABFY	42 (Concedida S/D), 35 (Concedida S/D) y 9 (Concedida S/D)	AMBIPAR ENVIRONMENTAL SOLUTIONS - SOLUÇÕES AMBIENTAIS LTDA.	34
528087	03/11/2022	LACC (mixta)	39 (Concedida)	TCU S.A.	212
528089	03/11/2022	LATIN AMERICA CARGO CITY (mixta)	39 (Concedida)	TCU S.A.	212
528090	14/11/2022	JO'S LAUNDRY	3 (Concedida S/D)	Gaz & Jo Intellectual Property Holdings Limited	245
528091	04/11/2022	LABBI (mixta)	9 (Concedida)	Labbi Ventures S.A.	212
528092	04/11/2022	LABBI (mixta)	35 (Concedida)	Labbi Ventures S.A.	212
528093	03/11/2022	LABBI (mixta)	36 (Concedida)	Labbi Ventures S.A.	212
528094	03/11/2022	LABBI (mixta)	42 (Concedida)	Labbi Ventures S.A.	212
528095	03/11/2022	LABBI (mixta)	44 (Concedida)	Labbi Ventures S.A.	212
528096	14/11/2022	ECODESIGN (mixta)	35 (Concedida), 32 (Concedida), 30 (Concedida), 29 (Concedida)	DECATHLON SE	194

N° Exp	Resolución	Marca	Clases	Titular	Ag.
			(Concedida), 28 (Concedida), 25 (Concedida), 24 (Concedida), 22 (Concedida), 21 (Concedida), 20 (Concedida), 18 (Concedida), 14 (Concedida), 12 (Concedida), 11 (Concedida), 9 (Concedida) y 3 (Concedida)		
528097	03/11/2022	PAMPA	32 (Concedida)	LA YUNGERÉ S.A.	201
528098	03/11/2022	GRIN	36 (Concedida)	FUCAC VERDE COOPERATIVA DE AHORRO Y CREDITO	201
528104	24/10/2022	SANSUEÑA	44 (Concedida), 43 (Concedida) y 41 (Concedida)	David Rafael Rivera	
528108	24/10/2022	ALIÑO (mixta)	5 (Concedida)	MARIO LEV BURCIKUS	219
528110	24/10/2022	TRES FUEGOS (mixta)	43 (Concedida)	Ana Montiel y Sergio Sebastian Mattos	94
528116	28/10/2022	TEZACAR	5 (Concedida S/D)	LABORATORIO GADOR S.A.	165
528117	28/10/2022	STARLIA+	41 (Concedida S/D) y 38 (Concedida S/D)	Disney Enterprises, Inc.	144
528118	28/10/2022	STARLIA	41 (Concedida S/D) y 38 (Concedida S/D)	Disney Enterprises, Inc.	144
528119	11/11/2022	KUMAGRO	31 (Concedida S/D)	KUMAGRO S.A.U.	144
528129	24/10/2022	SOME BY MI (mixta)	3 (Concedida S/D)	PERENNEBELL Co., Ltd	34
528136	24/10/2022	B BIDÚ (mixta)	32 (Concedida)	KALSTEIN, EDGAR	34

N° Exp	Resolución	Marca	Clases	Titular	Ag.
528145	24/10/2022	LECTURITA (mixta)	35 (Concedida S/D)	ALONSO, MARIA CELINA	201
528148	24/10/2022	LITUMBIA	5 (Concedida S/D)	F. HOFFMANN-LA ROCHE AG	201
528149	24/10/2022	PIASKY	5 (Concedida S/D)	CHUGAI SEIYAKU KABUSHIKI KAISHA (Chugai Pharmaceutical Co., Ltd.)	201
528150	24/10/2022	TUTTI CATTI	29 (Concedida)	CATTIVELLI HNOS. S.A.	129
528152	24/10/2022	MOLÉ (mixta)	29 (Concedida)	MOLE S.R.L.	179
528161	24/10/2022	SUNLUMIO	5 (Concedida S/D)	F. HOFFMANN-LA ROCHE AG	201
528171	28/10/2022	HIGHFIELD (mixta)	12 (Concedida S/D)	HIGHFIELD BOATS AUSTRALIA PTY LTD	94
528174	28/10/2022	URBAN AUTHENTIC EST. 1970 (mixta)	25 (Concedida)	INDUSTRIAS CALZAR, S.A.	144
528175	24/10/2022	EE (mixta)	42 (Concedida S/D) y 1 (Concedida S/D)	Spogen Biotech, Inc.	194
528177	24/10/2022	VISMAX	1 (Concedida S/D)	Spogen Biotech, Inc.	194
528178	24/10/2022	VISMAX (mixta)	1 (Concedida S/D)	Spogen Biotech, Inc.	194
528179	24/10/2022	ACRIMAR	2 (Concedida)	RENNER HERRMANN S.A.	194
528180	24/10/2022	MARTIN (mixta)	7 (Concedida S/D)	MARTIN SPROCKET & GEAR, INC.	194
528181	24/10/2022	MARTIN (mixta)	7 (Concedida S/D)	MARTIN SPROCKET & GEAR, INC.	194
528183	24/10/2022	OATIBIX	30 (Concedida S/D)	Weetabix Limited	212
528184	28/10/2022	SOFIDERM (mixta)	10 (Concedida S/D), 5 (Concedida S/D) y 3 (Concedida S/D)	HANGZHOU TECHDERM BIOLOGICAL PRODUCTS CO., LTD.	34
528186	28/10/2022	MUST ENERGY (mixta)	9 (Concedida S/D)	Must Energy(Guangdong)Technology Co.,LTD	34
528188	28/10/2022	ANA MEDICIONES (mixta)	42 (Concedida), 38 (Concedida) y 35 (Concedida)	ANA MEDICIONES SAS	212
528189	28/10/2022	ANA ANALISIS DE AUDIENCIA (mixta)	42 (Concedida), 38 (Concedida) y 35 (Concedida)	ANA MEDICIONES SAS	212
528191	28/10/2022	DRONE CNTROL (mixta)	41 (Concedida S/D), 39 (Concedida S/D) y 35 (Concedida)	Diego Martín Barreto Palacio	

N° Exp	Resolución	Marca	Clases	Titular	Ag.
			S/D)		
528193	28/10/2022	FIONA INDUMENTARIA (mixta)	35 (Concedida) y 25 (Concedida S/D)	Florencia Merica	
528194	28/10/2022	6 X 6 FULL	5 (Concedida S/D)	COMPANÍA CIBELES S.A.	184
528196	28/10/2022	COMPASS INFINITY	9 (Concedida S/D) y 7 (Concedida S/D)	Otis Elevator Company	179
528204	28/10/2022	BIOJET-LIFE	10 (Concedida S/D)	BIOSIDUS S.A.	201
528205	11/11/2022	WENANCE	38 (Concedida), 36 (Concedida) y 9 (Concedida)	Alejandro Muszak	229
528207	28/10/2022	GLASHAUS (mixta)	19 (Concedida S/D)	Edir Luiz Nonino	
528208	28/10/2022	SINERXIA INNOVAMOS TU CAMINO (mixta)	19 (Concedida S/D) y 17 (Concedida S/D)	Fernando Marcelo Coppola Novo	
528209	28/10/2022	ARMONÍA COUNTRY CLUB (mixta)	41 (Concedida S/D)	Fernando Marcelo Coppola Novo	
528210	28/10/2022	RIB´S THE BEST BURGER (mixta)	43 (Concedida) y 35 (Concedida)	ELBIO WASHINGTON RUIZ	239
528215	28/10/2022	SARLUX S.A. (mixta)	42 (Concedida) y 37 (Concedida)	SARLUX S.A.	189
528216	28/10/2022	YOLIFE (mixta)	29 (Concedida)	VILLANUEVA, EDGARDO IGNACIO	245
528219	28/10/2022	VIOZA	5 (Concedida S/D)	Himalaya Global Holdings Ltd.	144
528221	28/10/2022	BE HAPPY BE SAFE	5 (Concedida) y 3 (Concedida)	ELECTRON S.A.	165
528225	28/10/2022	VYLEESI	5 (Concedida S/D)	Palatin Technologies, Inc.	216
528226	28/10/2022	PORFIADO RECORDS (mixta)	35 (Concedida) y 9 (Concedida)	PIANA FRADILETTI VERONICA, PINTOS VALLES ALVARO DANIEL Y OTROS SOCIEDAD DE HECHO	216
528232	28/10/2022	HAIR FARMACITY	3 (Concedida)	FARMCITY S.A.	245
528238	28/10/2022	HAIR FARMACITY (mixta)	3 (Concedida)	FARMCITY S.A.	245
528242	11/11/2022	PROTERLINE	31 (Concedida)	ALICAN S.A.	212
528243	14/11/2022	HOMEMADE DELIGHTS (mixta)	31 (Concedida)	ALICAN S.A	212

N° Exp	Resolución	Marca	Clases	Titular	Ag.
528245	23/11/2022	SMARTLINK (mixta)	42 (Concedida) y 35 (Concedida)	Alvaro Dominguez Castillo; Mathias Gratadoux Tancredi y Martin Calloia Busto	212
528246	28/10/2022	GYNODERM	3 (Concedida S/D)	LABORATORIOS IMVI S.A.	220
528247	28/10/2022	VARISEDAN	5 (Concedida S/D) y 3 (Concedida S/D)	LABORATORIOS IMVI S.A.	220
528249	03/11/2022	DERMAVIVE	44 (Concedida S/D) y 5 (Concedida S/D)	UAS PHARMACEUTICALS PTY LTD.	189
528253	28/10/2022	MESTIZA & CO.	25 (Concedida), 23 (Concedida) y 18 (Concedida)	ANGI MARIQUENA REYES ROSALES y CINDY ROSALIA TUR RAMIREZ	
528254	28/10/2022	S-5! (mixta)	6 (Concedida S/D)	Caught Fish Enterprises, L.L.C.	136
528257	21/11/2022	INMOBILIARIA PUNTA COLORADA (mixta)	36 (Concedida S/D)	OJEDA DIAZ, VICTOR JOSE	201
528259	28/10/2022	DOSESAVER	10 (Concedida S/D)	NIPRO CORPORATION	136
528260	28/10/2022	KAURI	21 (Concedida)	María Victoria Díaz Lago	217
528263	28/10/2022	OPTIMA	9 (Concedida S/D)	CPS Technology holdings LLC	165
528265	28/10/2022	ALTERCARGO	39 (Concedida)	Andrew Raquet	181
528268	28/10/2022	REMEDY & ASOCIADOS (mixta)	41 (Concedida S/D) y 35 (Concedida S/D)	Antonio Nicolás Remedi Rumi	
528273	28/10/2022	PEDIDOSYA FRESH	39 (Concedida S/D) y 35 (Concedida S/D)	DELIVERY HERO LATAM MARKETPLACE HOLDING S.A.	34
528274	28/10/2022	PEDIDOSYA MERCHANT	42 (Concedida S/D), 39 (Concedida S/D), 35 (Concedida S/D) y 9 (Concedida S/D)	DELIVERY HERO LATAM MARKETPLACE HOLDING S.A.	34
528279	28/10/2022	NETTE DESIGN (mixta)	42 (Concedida)	Florencia Andregnette Irazabal	212
528280	14/11/2022	NAT (mixta)	35 (Concedida), 32 (Concedida), 31 (Concedida), 30	FARMCITY S.A.	245

N° Exp	Resolución	Marca	Clases	Titular	Ag.
			(Concedida) y 29 (Concedida)		
528284	28/10/2022	2DO ALMACEN DEL CABALLITO (mixta)	43 (Concedida)	Martín Gastaldi Peyrou	194
528285	28/10/2022	QUETE DISEÑO (mixta)	42 (Concedida), 35 (Concedida) y 16 (Concedida)	BOTTARO CARVE MARIA MAGDALENA Y CARBAJALES DUPONT MARIA DOLORES (sociedad de hecho)	
528290	15/11/2022	SMIDEL BAR	43 (Concedida S/D) y 41 (Concedida)	Luis Manuel Campelo Rodriguez	212
528292	11/11/2022	MARTINI LINEA GELATO (mixta)	35 (Concedida), 31 (Concedida), 30 (Concedida S/D) y 29 (Concedida)	Unigrà S.r.l.	194
528293	28/10/2022	MM MASTER MARTINI (mixta)	35 (Concedida), 30 (Concedida) y 29 (Concedida)	Unigrà S.r.l.	194
528294	11/11/2022	ORASI (mixta)	35 (Concedida), 32 (Concedida), 31 (Concedida), 30 (Concedida) y 29 (Concedida)	Unigrà S.r.l.	194
528295	11/11/2022	U UNIGRA (mixta)	35 (Concedida), 31 (Concedida), 30 (Concedida) y 29 (Concedida)	Unigrà S.r.l.	194
528297	28/10/2022	SISTEMA COMFORT TECNOLOGÍA RPT (mixta)	6 (Concedida)	ALUMINIOS DEL URUGUAY S.A.	212
528298	28/10/2022	SISTEMA COMFORT TECNOLOGÍA RPT (mixta)	19 (Concedida)	ALUMINIOS DEL URUGUAY S.A.	212
528299	28/10/2022	BURGER MOOD (mixta)	43 (Concedida)	Federico Lorenzo	
528300	31/10/2022	LTH (mixta)	9 (Concedida S/D)	CPS Technology holdings LLC	144

N° Exp	Resolución	Marca	Clases	Titular	Ag.
528302	31/10/2022	FESTILINDO	35 (Concedida), 16 (Concedida) y 9 (Concedida)	GROZAV MEDIA LLC	220
528303	31/10/2022	VITA	5 (Concedida S/D) y 3 (Concedida S/D)	Venus Laboratories, Inc.	194
528309	31/10/2022	BENTEVEO	42 (Concedida S/D) y 20 (Concedida S/D)	Nicolas Echeverria	
528311	07/11/2022	SEGUÍTUBUS (mixta)	9 (Concedida)	GRALADO S.A.	34
528323	31/10/2022	ENTERIA (mixta)	42 (Concedida)	DRAUNIA S.A.	201
528324	31/10/2022	ALOT (mixta)	28 (Concedida)	OFFICENET S.A.	201
528331	31/10/2022	NAN JI REN (mixta)	25 (Concedida S/D), 24 (Concedida S/D) y 18 (Concedida S/D)	Nanji E-commerce (Shanghai) Ltd.	245
528332	31/10/2022	HEPCLUDEX	5 (Concedida S/D)	MYR GmbH	245
528337	01/11/2022	LA FAMILIA DEL PANE	30 (Concedida S/D)	CASTELLANOS, MAURICIO	189
528341	01/11/2022	+DEPORTES UY -OTRA FORMA DE VER DEPORTE- (mixta)	41 (Concedida S/D) y 38 (Concedida S/D)	SECRETARIA NACIONAL DEL DEPORTE	
528342	07/11/2022	+DEPORTES UY -OTRA FORMA DE VER DEPORTE- (mixta)	41 (Concedida S/D) y 38 (Concedida S/D)	SECRETARIA NACIONAL DEL DEPORTE	
528343	31/10/2022	TU MATE (mixta)	21 (Concedida S/D) y 18 (Concedida S/D)	RICARDO ARIEL LAIN	
528344	31/10/2022	EMPORIO FERRETERO (mixta)	35 (Concedida)	DANIEL PESCE	
528345	31/10/2022	H R HUAFA PPR FITTING (mixta)	17 (Concedida)	DANIEL PESCE	
528346	01/11/2022	PERFECT POWER (mixta)	7 (Concedida S/D)	GUANGZHOU JINGJIA AUTO EQUIPMENT CO., LTD.	201
528347	31/10/2022	BEROTEC	5 (Concedida S/D)	Boehringer Ingelheim Pharma GmbH & Co. KG	136

N° Exp	Resolución	Marca	Clases	Titular	Ag.
528348	31/10/2022	TARASHI (mixta)	28 (Concedida)	William Povero	
528349	31/10/2022	BOEHRINGER INGELHEIM	5 (Concedida S/D)	Boehringer Ingelheim Pharma GmbH & Co. KG	136
528351	01/11/2022	RADIGITAL RED ACADÉMICA PARA LA TRANSFORMACIÓN DIGITAL (mixta)	42 (Concedida S/D), 41 (Concedida S/D) y 9 (Concedida S/D)	ASOCIACIÓN RED ACADÉMICA PARA LA TRANSFORMACIÓN DIGITAL	94
528353	01/11/2022	DANZATERAPIA&DMT URUGUAY 1ER. CENTRO DEL URUGUAY (mixta)	44 (Concedida) y 41 (Concedida)	Mariana Maggiari	
528354	31/10/2022	PRESENT (mixta)	21 (Concedida), 20 (Concedida) y 11 (Concedida)	SORIA SUAREZ JORGE EFRAIN	220
528357	31/10/2022	OPTIMA (mixta)	9 (Concedida S/D)	CPS Technology holdings LLC	144
528359	31/10/2022	VISMA (mixta)	42 (Concedida S/D) y 9 (Concedida S/D)	WOLFTECH SRL	144
528362	01/11/2022	LA VOZ URUGUAY (mixta)	41 (Concedida S/D) y 9 (Concedida S/D)	ITV Studios Netherlands Content B.V.	34
528363	31/10/2022	(figurativa)	29 (Concedida)	CRUFI S.A.	212
528366	31/10/2022	JUNTOS + (mixta)	42 (Concedida S/D), 38 (Concedida S/D), 35 (Concedida S/D) y 9 (Concedida S/D)	Coca-Cola Femsa S.A.B. de C.V.	216
528367	14/11/2022	NEW AGE DATA SOLUCIONES INFORMÁTICAS EMPRESARIALES (mixta)	36 (Concedida) y 35 (Concedida)	PHOENIX S.A.	216
528369	31/10/2022	SUPERSTORE	36 (Concedida) y 35 (Concedida)	PHOENIX S.A.	216
528371	31/10/2022	GENAI CONSULTING	42 (Concedida S/D)	AILOGSYS SRL	
528372	10/11/2022	NAD-CAJA	36 (Concedida) y 35 (Concedida)	PHOENIX S.A.	216
528374	31/10/2022	WAV	25 (Concedida), 24 (Concedida), 16	FINANGROUP S.A.	245

N° Exp	Resolución	Marca	Clases	Titular	Ag.
			(Concedida), 14 (Concedida), 5 (Concedida), 3 (Concedida) y 1 (Concedida)		
528376	31/10/2022	WAV (mixta)	25 (Concedida), 24 (Concedida), 16 (Concedida), 14 (Concedida), 5 (Concedida), 3 (Concedida) y 1 (Concedida)	FINANGROUP S.A.	245
528381	31/10/2022	RED BULL BRAGANTINO (mixta)	25 (Concedida)	Red Bull GmbH	192
528383	31/10/2022	4 SQUARE (mixta)	3 (Concedida S/D)	SORA KOZMETIK SANAYI TICARET ANONIM SIRKETI	192
528384	31/10/2022	FERRETERÍA 88	35 (Concedida)	NESTOR WULF	129
528391	31/10/2022	(figurativa)	38 (Concedida S/D)	Pettigo Comércio Internacional, Lda	179
528401	16/11/2022	PCSO-524	5 (Concedida)	PHARMALINK INTERNATIONAL LIMITED	105
528402	16/11/2022	FLO FRONTINI	41 (Concedida)	FRONTINI MEDINA, MARIA FLORENCIA	94
528403	28/10/2022	SUENAUUGUAY (mixta)	41 (Concedida), 38 (Concedida) y 35 (Concedida)	ANDRES SANABRIA y RODRIGO DANIEL BORRAZÁS ESQUIVEL	94
528404	28/10/2022	BE YOU (mixta)	41 (Concedida)	FRONTINI MEDINA, MARIA FLORENCIA	94
528405	24/11/2022	BE HEALTHY (mixta)	41 (Concedida)	FRONTINI MEDINA, MARIA FLORENCIA	94
528406	21/11/2022	BE MINDFUL (mixta)	41 (Concedida)	FRONTINI MEDINA, MARIA FLORENCIA	94
528409	28/10/2022	ROBOROCK (mixta)	9 (Concedida S/D)	Beijing Roborock Technology Co., Ltd.	144
528410	31/10/2022	Z (mixta)	9 (Concedida S/D)	Beijing Roborock Technology Co., Ltd.	144
528425	16/11/2022	ESPO-572	29 (Concedida S/D) y 5 (Concedida S/D)	PHARMALINK INTERNATIONAL LIMITED	105
528427	07/11/2022	VERBANO	21 (Concedida)	FAIART ARGENTINA S.A.	34
528428	07/11/2022	CAMARA DE COMERCIO E	35 (Concedida)	Cámara de Comercio e Industria Franco	34

N° Exp	Resolución	Marca	Clases	Titular	Ag.
		INDUSTRIA FRANCO URUGUAYA CCIFU		Uruguaya	
528430	28/10/2022	OPTA (mixta)	42 (Concedida) y 37 (Concedida)	Sergio Brizouski y Rafael Ferreira	181
528431	24/11/2022	YPF ELAION AURO TEC TECNOLOGÍA EN EVOLUCIÓN CONSTANTE (mixta)	4 (Concedida S/D) y 1 (Concedida S/D)	YPF S.A.	34
528432	28/10/2022	VASSER	11 (Concedida)	VASSER S.A.	34
528436	31/10/2022	PETBA	35 (Concedida), 31 (Concedida) y 5 (Concedida)	PETBA SA.	181
528437	15/11/2022	DE CAMPO NATURAL GRSSLIFE URUGUAY (mixta)	43 (Concedida), 42 (Concedida), 35 (Concedida), 29 (Concedida) y 18 (Concedida)	CARNES DEL PASTIZAL LIMITADA	
528438	07/11/2022	CN CASA NARANJA (mixta)	35 (Concedida)	Basicenter SA	181
528442	15/11/2022	RELX (mixta)	34 (Concedida S/D)	Shenzhen Relx Technology Co., Ltd	34
528444	28/10/2022	CAPITAN CUAC	30 (Concedida)	MANTRA S.A.	144
528450	31/10/2022	GALVACRYL	2 (Concedida S/D)	PPG INDUSTRIAL DO BRASIL-TINTAS E VERNIZES-LTDA.	144
528451	07/11/2022	H HISTORY (mixta)	41 (Concedida S/D), 38 (Concedida S/D) y 9 (Concedida S/D)	A&E Television Networks, LLC	144
528452	03/11/2022	TRICHODERMIL (mixta)	1 (Concedida S/D)	KOPPERT DO BRASIL HOLDING LTDA.	212
528453	11/11/2022	TRICHODERMIL (mixta)	5 (Concedida S/D)	KOPPERT DO BRASIL HOLDING LTDA.	212
528455	07/11/2022	BOVERIL (mixta)	5 (Concedida S/D)	KOPPERT DO BRASIL HOLDING LTDA.	212
528456	16/11/2022	METARRIL (mixta)	5 (Concedida S/D)	KOPPERT DO BRASIL HOLDING LTDA.	212
528458	03/11/2022	CHALLENGER (mixta)	5 (Concedida S/D)	KOPPERT DO BRASIL HOLDING LTDA.	212
528459	11/11/2022	TRIANUM (mixta)	1 (Concedida S/D)	KOPPERT DO BRASIL HOLDING LTDA.	212
528462	28/10/2022	TRIANUM (mixta)	5 (Concedida S/D)	KOPPERT DO BRASIL HOLDING LTDA.	212

N° Exp	Resolución	Marca	Clases	Titular	Ag.
528464	11/11/2022	VERANEIO (mixta)	1 (Concedida S/D)	KOPPERT DO BRASIL HOLDING LTDA.	212
528465	03/11/2022	VERANEIO (mixta)	5 (Concedida S/D)	KOPPERT DO BRASIL HOLDING LTDA.	212
528466	31/10/2022	SPICAL (mixta)	5 (Concedida S/D)	KOPPERT DO BRASIL HOLDING LTDA.	212
528467	11/11/2022	PRETIO BUG (mixta)	5 (Concedida S/D)	KOPPERT DO BRASIL HOLDING LTDA.	212
528468	11/11/2022	GOFIT (mixta)	44 (Concedida) y 41 (Concedida)	Ana Claudia Fuentes Gomez	101
528469	11/11/2022	GALLOI BUG (mixta)	5 (Concedida S/D)	KOPPERT DO BRASIL HOLDING LTDA.	212
528470	03/11/2022	PODISI BUG (mixta)	5 (Concedida S/D)	KOPPERT DO BRASIL HOLDING LTDA.	212
528474	21/11/2022	FUTBOLIKO FOOTBALL AGENCY BOUTIQUE BY GBG (mixta)	41 (Concedida) y 35 (Concedida)	BOSELLI OLIVERA, PABLO	201
528475	11/11/2022	ZONA LAB CIUDAD DEPORTIVA BY GBG (mixta)	41 (Concedida)	BOSELLI OLIVERA, PABLO	201
528476	28/10/2022	AZOKOP (mixta)	1 (Concedida S/D)	KOPPERT DO BRASIL HOLDING LTDA.	212
528477	03/11/2022	CAPSANEM (mixta)	5 (Concedida S/D)	KOPPERT DO BRASIL HOLDING LTDA.	212
528478	31/10/2022	AZOKOP (mixta)	5 (Concedida S/D)	KOPPERT DO BRASIL HOLDING LTDA.	212
528479	31/10/2022	LARVANEM (mixta)	5 (Concedida S/D)	KOPPERT DO BRASIL HOLDING LTDA.	212
528480	07/11/2022	METANIUM (mixta)	5 (Concedida S/D)	KOPPERT DO BRASIL HOLDING LTDA.	212
528481	11/11/2022	DAYTONA (mixta)	1 (Concedida S/D)	KOPPERT DO BRASIL HOLDING LTDA.	212
528482	11/11/2022	DAYTONA (mixta)	5 (Concedida S/D)	KOPPERT DO BRASIL HOLDING LTDA.	212
528483	07/11/2022	NATUTEC (mixta)	5 (Concedida S/D)	KOPPERT DO BRASIL HOLDING LTDA.	212
528484	03/11/2022	DETROIT (mixta)	5 (Concedida S/D)	KOPPERT DO BRASIL HOLDING LTDA.	212
528486	03/11/2022	FARMACITY (mixta)	45 (Concedida), 44 (Concedida), 43 (Concedida), 42 (Concedida), 41 (Concedida), 39 (Concedida), 38 (Concedida), 35 (Concedida), 32 (Concedida), 30 (Concedida), 29 (Concedida)	FARMACITY S.A.	245

N° Exp	Resolución	Marca	Clases	Titular	Ag.
			(Concedida), 28 (Concedida), 26 (Concedida), 25 (Concedida), 24 (Concedida), 21 (Concedida), 20 (Concedida), 18 (Concedida), 16 (Concedida), 14 (Concedida), 12 (Concedida), 11 (Concedida), 10 (Concedida), 9 (Concedida), 8 (Concedida), 6 (Concedida), 5 (Concedida), 4 (Concedida), 3 (Concedida) y 1 (Concedida)		
528487	11/11/2022	490°C, O, 490 GRADOS CELSIUS	43 (Concedida S/D)	Felipe Gonzalez	
528488	24/11/2022	HARD ROCK CASINO	41 (Concedida S/D) y 9 (Concedida)	Hard Rock Limited	179
528489	11/11/2022	SALIO VIAJE	39 (Concedida)	Gustavo Gutierrez	
528491	21/11/2022	HARD ROCK POKER	41 (Concedida) y 9 (Concedida)	Hard Rock Limited	179
528492	21/11/2022	HARD ROCK POKER (mixta)	41 (Concedida) y 9 (Concedida)	Hard Rock Limited	179
528493	03/11/2022	EXO IJ (mixta)	10 (Concedida S/D)	JOHNNY CARDOZO y Ruben Ismael Acosta Laurini	
528495	17/11/2022	HARD ROCK SPORTS (mixta)	41 (Concedida) y 9	Hard Rock Limited	179

N° Exp	Resolución	Marca	Clases	Titular	Ag.
			(Concedida)		
528496	08/11/2022	HARD ROCK SPORTSBOOK	41 (Concedida), 25 (Concedida) y 9 (Concedida)	Hard Rock Limited	179
528497	21/11/2022	HARD ROCK SPORTSBOOK (mixta)	41 (Concedida), 25 (Concedida) y 9 (Concedida)	Hard Rock Limited	179
528501	03/11/2022	HAY OTRA MIRADA (mixta)	33 (Concedida S/D)	Pernod Ricard Argentina S.R.L.	205
528504	03/11/2022	SAXO GROUP (mixta)	36 (Concedida S/D)	Saxo Bank A/S	94
528505	03/11/2022	SAXO BANK (mixta)	36 (Concedida S/D)	Saxo Bank A/S	94
528507	03/11/2022	+DEPORTES UY -OTRA FORMA DE VER DEPORTE- (mixta)	41 (Concedida S/D) y 38 (Concedida S/D)	SECRETARIA NACIONAL DEL DEPORTE	
528510	03/11/2022	ACUDA	45 (Concedida S/D)	PROSEGUR Compañía de Seguridad, S.A.	144
528512	03/11/2022	CLEARSCORE PROTECT (mixta)	45 (Concedida S/D), 36 (Concedida S/D) y 35 (Concedida S/D)	Clear Score Technology Limited	216
528514	03/11/2022	THALOZ. (mixta)	42 (Concedida)	CASSIEL S.A.S.	220
528515	04/11/2022	ZYNYZ	16 (Concedida S/D)	Incyte Holdings Corporation	212
528520	04/11/2022	ZYNYZ Z (mixta)	16 (Concedida S/D)	Incyte Holdings Corporation	212
528521	04/11/2022	Z (mixta)	16 (Concedida S/D)	Incyte Holdings Corporation	212
528530	21/11/2022	LOVE IS IN MY HAIR	44 (Concedida S/D)	The Procter & Gamble Company	212
528532	03/11/2022	MI MÁ (mixta)	30 (Concedida)	Amira Nemer Jourdan	19
528533	03/11/2022	MUNDO FW (mixta)	18 (Concedida) y 16 (Concedida)	RUGGIERO, ALDO FABIO	201
528535	03/11/2022	FW (mixta)	18 (Concedida) y 16 (Concedida)	RUGGIERO, ALDO FABIO	201
528537	03/11/2022	GELATÍSSIM (mixta)	30 (Concedida S/D)	GELATS EL VETERÀ, S.L.	201
528538	03/11/2022	OASIS	17 (Concedida) y 1 (Concedida)	Smithers-Oasis Company	201

N° Exp	Resolución	Marca	Clases	Titular	Ag.
528539	03/11/2022	KENTUCKY FUEGO DESDE 1942 (mixta)	43 (Concedida S/D) y 30 (Concedida S/D)	COMERIX S.A.	94
528540	03/11/2022	TERRABRICK (mixta)	17 (Concedida S/D) y 1 (Concedida S/D)	Smithers-Oasis Company	201
528541	23/11/2022	DESIGN MASTER	2 (Concedida)	Smithers-Oasis Company	201
528542	03/11/2022	NUTRIKIDS (mixta)	30 (Concedida)	FIGLIOLIO GROSSO PAOLA ANALIA	220
528543	04/11/2022	(tridimensional)	30 (Concedida)	FIGLIOLIO GROSSO PAOLA ANALIA	220
528544	03/11/2022	PUZZLE DE CHOCLO	30 (Concedida)	FIGLIOLIO GROSSO PAOLA ANALIA	220
528548	03/11/2022	EH EL HORNERO (mixta)	25 (Concedida)	EL HORNERO S.A.	192
528555	03/11/2022	(figurativa)	2 (Concedida S/D)	PPG INDUSTRIES OHIO, INC.	144
528558	03/11/2022	MIDATUS (mixta)	5 (Concedida S/D)	INSTITUTO BIOLOGICO ARGENTINO S.A.I.C.	219
528562	03/11/2022	CHEEZ-IT	30 (Concedida S/D)	KELLOGG COMPANY	194
528563	04/11/2022	HOME SWEET HOME PROPIEADADES (mixta)	36 (Concedida)	Dahiana Señorís Sabate	212
528566	03/11/2022	HEXAFLUORINE	5 (Concedida S/D)	Joël BLOMET	34
528567	03/11/2022	ORGANISMO URUGUAYO DE ACREDITACIÓN (mixta)	42 (Concedida) y 35 (Concedida)	Organismo Uruguayo de Acreditación	245
528569	03/11/2022	OPZELURA	44 (Concedida S/D), 16 (Concedida S/D) y 5 (Concedida S/D)	Incyte Holdings Corporation	212
528571	04/11/2022	SPLASH ! (mixta)	43 (Concedida)	CVIZONAS LASZCZOWER NICOLE NURIT Y CARDOZO RIFRAN ARMANDO	245
528572	04/11/2022	SOY PEPE EL REY DE LAS TORTAFRITAS, EL REY DE LA TORTAFRITA (mixta)	43 (Concedida) y 30 (Concedida S/D)	CARABALLO, JOSE	245
528573	04/11/2022	RITUAL TATTOO (mixta)	44 (Concedida)	Pablo Brea	212
528574	03/11/2022	DIPHOTERINE	45 (Concedida S/D), 41 (Concedida S/D), 11 (Concedida S/D),	Joël BLOMET	34

N° Exp	Resolución	Marca	Clases	Titular	Ag.
			10 (Concedida S/D), 9 (Concedida S/D), 5 (Concedida S/D), 3 (Concedida S/D) y 1 (Concedida S/D)		
528575	14/11/2022	EDM EMPANADAS DEL MUNDO (mixta)	43 (Concedida), 31 (Concedida), 30 (Concedida S/D) y 29 (Concedida)	ANA LETICIA CHAPPE HERNANDEZ	
528576	03/11/2022	(figurativa)	43 (Concedida S/D), 41 (Concedida S/D), 34 (Concedida S/D), 33 (Concedida S/D), 32 (Concedida S/D), 30 (Concedida S/D), 28 (Concedida S/D) y 25 (Concedida)	Red Bull GmbH	192
528582	14/11/2022	DE RAIZ (mixta)	44 (Concedida) y 31 (Concedida S/D)	BENTANCOR REVUELTA, ARIEL NICOLAS	
528592	04/11/2022	PRIME AGRO (mixta)	35 (Concedida S/D)	PRIME AGRO PRODUTOS AGRÍCOLAS LTDA	144
528593	04/11/2022	PRIME NUTRE BORO (mixta)	1 (Concedida S/D)	PRIME AGRO PRODUTOS AGRÍCOLAS LTDA	144
528594	04/11/2022	CASTER (mixta)	1 (Concedida S/D)	PRIME AGRO PRODUTOS AGRÍCOLAS LTDA	144
528595	04/11/2022	CARTOSI (mixta)	1 (Concedida S/D)	PRIME AGRO PRODUTOS AGRÍCOLAS LTDA	144
528596	04/11/2022	UNDERI (mixta)	1 (Concedida S/D)	PRIME AGRO PRODUTOS AGRÍCOLAS LTDA	144
528597	04/11/2022	FOCUS (mixta)	1 (Concedida S/D)	PRIME AGRO PRODUTOS AGRÍCOLAS LTDA	144

N° Exp	Resolución	Marca	Clases	Titular	Ag.
528599	03/11/2022	ARCOR CHOCO BOX (mixta)	30 (Concedida S/D)	ARCOR S.A.I.C.	154
528600	01/11/2022	AMAMOS LA PIZZA	43 (Concedida S/D)	COMERIX S.A.	94
528601	01/11/2022	NH DISCOVERY (mixta)	43 (Concedida S/D)	NH HOTEL GROUP, S.A.	144
528602	01/11/2022	FUEGO DESDE 1942	43 (Concedida S/D)	COMERIX S.A.	94
528604	01/11/2022	LA MEJOR PIZZA DESDE 1942	43 (Concedida S/D)	COMERIX S.A.	94
528605	31/10/2022	DANDY (mixta)	43 (Concedida S/D)	COMERIX S.A.	94
528606	01/11/2022	LA CENA DE LOS SENTIDOS	43 (Concedida)	MARTINEZ RIBERO, CARLOS ULISES	201
528607	01/11/2022	MYRENOVA.COM RENOVA (mixta)	16 (Concedida S/D)	RENOVA - Fábrica de Papel do Almonda, S.A.	34
528611	01/11/2022	TECVAYLI	5 (Concedida S/D)	JOHNSON & JOHNSON	194
528612	07/11/2022	LINEUP (mixta)	41 (Concedida), 38 (Concedida) y 35 (Concedida)	LINEUP SAS	34
528615	01/11/2022	DOMINI (mixta)	37 (Concedida), 36 (Concedida) y 35 (Concedida)	ALFREDO KAPLAN; JULIO DOLDÁN y PABLO SZAMES	34
528616	10/11/2022	VINILO DE ORO	14 (Concedida S/D)	CAMARA URUGUAYA DEL DISCO (CUD)	
528619	10/11/2022	VINILO DE PLATINO	14 (Concedida S/D)	CAMARA URUGUAYA DEL DISCO (CUD)	52
528621	21/11/2022	LA MORADA FIESTAS & EVENTOS (mixta)	43 (Concedida) y 41 (Concedida S/D)	Andrea Carolina Riera Lereté	232
528625	14/11/2022	AKER CLEAN HYDROGEN (mixta)	42 (Concedida S/D), 41 (Concedida S/D), 40 (Concedida S/D), 39 (Concedida S/D), 37 (Concedida S/D), 36 (Concedida S/D), 35 (Concedida S/D), 12 (Concedida S/D), 11 (Concedida S/D), 9 (Concedida S/D), 7 (Concedida S/D), 4 (Concedida S/D) y	Intellectual Property Holdings AS	245

N° Exp	Resolución	Marca	Clases	Titular	Ag.
			1 (Concedida S/D)		
528626	31/10/2022	CARINO	11 (Concedida), 9 (Concedida), 8 (Concedida) y 7 (Concedida)	SIMFER DAYANIKLI TÜKETİM MAMÜLLERİ TICARET VE SANAYİ ANONİM ŞİRKETİ	201
528627	16/11/2022	SPM SISTEMA PANELIZADO MONTFRIO (mixta)	37 (Concedida), 19 (Concedida), 17 (Concedida) y 11 (Concedida)	Joaquín Olaso	220
528628	07/11/2022	DISTRIBUIDORA ALL IN ONE	39 (Concedida) y 35 (Concedida)	GABRIEL VALLS SPOSITO	129
528629	07/11/2022	ALL IN ONE	39 (Concedida) y 35 (Concedida)	GABRIEL VALLS SPOSITO	129
528630	01/11/2022	DISTRIBUIDORA DEL BUCEO	39 (Concedida) y 35 (Concedida)	GABRIEL VALLS SPOSITO	129
528631	01/11/2022	DISTRIBUIDORA FRUGONI	39 (Concedida) y 35 (Concedida)	GABRIEL VALLS SPOSITO	129
528632	31/10/2022	GAXY	1 (Concedida S/D)	UPL Corporation Ltd	144
528638	07/11/2022	SICAMBIO (mixta)	16 (Concedida)	juan Borrelli	
528639	31/10/2022	PETMED	5 (Concedida S/D)	VALLECILLA B Y VALLECILLA M Y CIA SCA CARVAL DE COLOMBIA	94
528640	01/11/2022	SUPER MARIO	28 (Concedida S/D), 25 (Concedida S/D), 18 (Concedida S/D) y 9 (Concedida S/D)	Nintendo of America Inc.	136
528641	14/11/2022	CICLA CONTROL INTELIGENTE DE CAUDALIMETROS (mixta)	42 (Concedida S/D), 9 (Concedida S/D) y 7 (Concedida S/D)	Luis Alberto Puga	181
528642	10/11/2022	MOBIL DELVAC MODERN	4 (Concedida S/D)	Exxon Mobil Corporation	136
528643	01/11/2022	PARITERIB TUTEUR	5 (Concedida S/D)	TUTEUR S.A.C.I.F.I.A.	201
528646	07/11/2022	FRANQUICIAS QUE CRECEN (mixta)	35 (Concedida)	SIMONETTI, DANIEL LORENZO	201

N° Exp	Resolución	Marca	Clases	Titular	Ag.
528648	01/11/2022	PRIMAVERA SOUND	41 (Concedida S/D), 35 (Concedida S/D), 25 (Concedida S/D), 16 (Concedida S/D) y 9 (Concedida S/D)	PRIMAVERA SOUND, S.L.	34
528649	01/11/2022	PRIMAVERA PRO	41 (Concedida S/D) y 35 (Concedida S/D)	PRIMAVERA SOUND, S.L.	34
528650	01/11/2022	JARDINES DEL ESTE (mixta)	44 (Concedida)	MACHADO BERMUDEZ, NICOLAS CARLOS	201
528651	01/11/2022	SEEDLIP	32 (Concedida S/D)	Seedlip Ltd	212
528652	14/11/2022	BARRACA GALLINAL TRABAJANDO JUNTOS (mixta)	35 (Concedida) y 19 (Concedida S/D)	AGINTUR SOCIEDAD ANONIMA	34
528654	31/10/2022	EXIMIA (mixta)	36 (Concedida)	BENCH SAS	186
528658	01/11/2022	GET THE LOOK	44 (Concedida), 38 (Concedida), 35 (Concedida), 25 (Concedida), 18 (Concedida), 14 (Concedida), 11 (Concedida), 9 (Concedida), 8 (Concedida), 5 (Concedida) y 3 (Concedida)	FARMCITY S.A.	245
528659	01/11/2022	GET THE LOOK (mixta)	44 (Concedida), 38 (Concedida), 35 (Concedida), 25 (Concedida), 18 (Concedida), 14 (Concedida), 11 (Concedida), 9	FARMCITY S.A.	245

N° Exp	Resolución	Marca	Clases	Titular	Ag.
			(Concedida), 8 (Concedida), 5 (Concedida) y 3 (Concedida)		
528660	10/11/2022	QUALIS GOURMET (mixta)	43 (Concedida)	CHRISTIAN ADRIAN CASTRO DIAZ	168
528663	10/11/2022	DIGITAL MARK	9 (Concedida S/D)	Javier Gancio	
528667	14/11/2022	LTECH (mixta)	35 (Concedida S/D)	Lorena Gonzalez	
528668	07/11/2022	PUNTOS GO	36 (Concedida) y 35 (Concedida)	THE BANK OF NOVA SCOTIA	94
528669	01/11/2022	SAXOWEALTHCARE	36 (Concedida S/D)	Saxo Bank A/S	94
528672	31/10/2022	FLEXIO (mixta)	42 (Concedida) y 35 (Concedida)	FINWRX URUGUAY S.A.S	220
528673	01/11/2022	DANDY DELI (mixta)	43 (Concedida S/D)	COMERIX S.A.	94
528674	01/11/2022	GRILL DANDY (mixta)	43 (Concedida S/D)	COMERIX S.A.	94
528675	31/10/2022	2 PRINCESAS	32 (Concedida)	Ruben Varaldo	
528678	31/10/2022	NUME (mixta)	1 (Concedida S/D)	PRIME AGRO PRODUTOS AGRÍCOLAS LTDA	226
528682	31/10/2022	COLBER	5 (Concedida S/D)	LUMINOVA PHARMA CORPORATION GmbH	212
528683	01/11/2022	RUXICOL	5 (Concedida S/D)	LUMINOVA PHARMA CORPORATION GmbH	212
528684	31/10/2022	SUVIAR	5 (Concedida S/D)	LUMINOVA PHARMA CORPORATION GmbH	212
528685	01/11/2022	ACRUX INMUEBLES (mixta)	36 (Concedida)	Marco Marella	181
528686	03/11/2022	EFINEX	5 (Concedida S/D)	LUMINOVA PHARMA CORPORATION GmbH	212
528687	03/11/2022	FLAMYDOL	5 (Concedida S/D)	LUMINOVA PHARMA CORPORATION GmbH	212
528688	03/11/2022	ILACOX	5 (Concedida S/D)	LUMINOVA PHARMA CORPORATION GmbH	212
528689	10/11/2022	BAMBUSER	38 (Concedida S/D), 35 (Concedida S/D) y 9 (Concedida S/D)	Bambuser AB	194
528692	03/11/2022	DIABEGLIC	5 (Concedida S/D)	LUMINOVA PHARMA CORPORATION GmbH	212
528694	03/11/2022	VIDARTIL	5 (Concedida S/D)	LUMINOVA PHARMA CORPORATION GmbH	212
528696	07/11/2022	ESCUELA DE NATUROPATÍA DEL URUGUAY (mixta)	41 (Concedida)	Isabel Yost	

N° Exp	Resolución	Marca	Clases	Titular	Ag.
528699	07/11/2022	DERMO TATTOO (mixta)	3 (Concedida)	DETAT S.A.S	101
528700	03/11/2022	GASVERIUM	5 (Concedida S/D)	LUMINOVA PHARMA CORPORATION GmbH	212
528701	03/11/2022	RESINITE	16 (Concedida)	LEPINPLAST S.A.	194
528702	03/11/2022	MENTA	39 (Concedida S/D)	LOPEZ BENITEZ, LUIS ALBERTO	201
528704	03/11/2022	OROPRIM	5 (Concedida S/D)	LUMINOVA PHARMA CORPORATION GmbH	212
528705	03/11/2022	VOE NIO	39 (Concedida S/D)	LOPEZ BENITEZ, LUIS ALBERTO	201
528706	03/11/2022	INSUGLAR	5 (Concedida S/D)	LUMINOVA PHARMA CORPORATION GmbH	212
528709	03/11/2022	CLAVUCID	5 (Concedida S/D)	LUMINOVA PHARMA CORPORATION GmbH	212
528711	03/11/2022	MINAGLIM	5 (Concedida S/D)	LUMINOVA PHARMA CORPORATION GmbH	212
528712	03/11/2022	STRONG (mixta)	11 (Concedida S/D), 9 (Concedida S/D) y 7 (Concedida S/D)	Shenzhen Skyworth Digital Technology Co., Ltd.	34
528713	04/11/2022	RIDA	10 (Concedida S/D) y 5 (Concedida S/D)	R - Biopharm AG	34
528714	04/11/2022	PERIPRIL	5 (Concedida S/D)	LUMINOVA PHARMA CORPORATION GmbH	212
528715	04/11/2022	SPORTMANIA FITNESS (mixta)	28 (Concedida S/D)	SPORTMANIA INDÚSTRIA E COMÉRCIO DE APARELHOS PARA GINÁSTICA LTDA.	34
528716	04/11/2022	ASPRAX	5 (Concedida S/D)	LUMINOVA PHARMA CORPORATION GmbH	212
528717	04/11/2022	STUDIO 9	21 (Concedida), 14 (Concedida), 8 (Concedida) y 3 (Concedida)	FINANGROUP S.A.	245
528718	07/11/2022	STUDIO 9 (mixta)	21 (Concedida), 14 (Concedida), 8 (Concedida) y 3 (Concedida)	FINANGROUP S.A.	245
528719	04/11/2022	JOBST	10 (Concedida S/D)	BSN medical GmbH	240
528721	04/11/2022	STUDIO 9 PROFESSIONAL	21 (Concedida), 14 (Concedida), 9 (Concedida), 8 (Concedida) y 3	FINANGROUP S.A.	245

N° Exp	Resolución	Marca	Clases	Titular	Ag.
			(Concedida)		
528722	04/11/2022	STUDIO 9 PROFESSIONAL (mixta)	21 (Concedida), 14 (Concedida), 9 (Concedida), 8 (Concedida) y 3 (Concedida)	FINANGROUP S.A.	245
528723	14/11/2022	LA ALFAJORERIA BY TELIZZIA (mixta)	43 (Concedida) y 30 (Concedida)	TELIZ SOSA MARTINA y COMESAÑA OUTEDA MATÍAS SOCIEDAD DE HECHO	
528726	04/11/2022	CATTIVELLI EXTRA (mixta)	29 (Concedida)	CATTIVELLI HNOS. S.A.	129
528727	04/11/2022	SENSAH (mixta)	12 (Concedida S/D)	Sensah Smart Sports Equipment Co., Ltd.	144
528728	04/11/2022	WIZELINE	42 (Concedida S/D), 41 (Concedida S/D) y 35 (Concedida S/D)	Wizeline, Inc.	144
528729	04/11/2022	KYMINASI	6 (Concedida)	BALMELLI, Fulvio	201
528732	11/11/2022	FUNDACION VERDE	45 (Concedida) y 41 (Concedida)	FUNDACION FUCAC	201
528737	11/11/2022	HOMEOPATÍA BOTÁNICA (mixta)	44 (Concedida) y 5 (Concedida)	Maria Claudia Begino Rodríguez	
528738	11/11/2022	E&A PERFORMANCE (mixta)	25 (Concedida)	SORIA SUAREZ JORGE EFRAIN	220
528739	11/11/2022	FAIRTRADE (mixta)	30 (Concedida S/D) y 3 (Concedida S/D)	Fairtrade Labelling Organizations International e.V.	219
528743	11/11/2022	TERRUÑO	30 (Concedida) y 29 (Concedida)	ALONZO MORENO, ALEX GASTÓN	189
528747	11/11/2022	JUSTANY (mixta)	37 (Concedida), 36 (Concedida) y 19 (Concedida)	JUSTANY S.A.	201
528748	11/11/2022	CCELL	34 (Concedida S/D) y 11 (Concedida S/D)	SHENZHEN SMOORE TECHNOLOGY LIMITED	185
528749	11/11/2022	PEUGEOT 301	12 (Concedida S/D)	Automobiles PEUGEOT	144

N° Exp	Resolución	Marca	Clases	Titular	Ag.
528750	23/11/2022	S HOTEL SOLERIOS (mixta)	43 (Concedida S/D)	LONEMAR S.A.	144
528753	11/11/2022	CHERVÒ	25 (Concedida) y 18 (Concedida)	Chervò S.p.A.	201
528754	11/11/2022	PARALEVA	30 (Concedida S/D)	LESAFFRE ET COMPAGNIE	144
528755	11/11/2022	INDEPENDENT GROUP (mixta)	39 (Concedida)	INDEPENDENT SHIP AGENTS S.A.	94
528758	11/11/2022	HUÉ (mixta)	25 (Concedida) y 18 (Concedida)	FERNANDEZ BORRAS, MARIA PIA	245
528759	14/11/2022	YIELD GIVING	41 (Concedida S/D), 36 (Concedida S/D) y 35 (Concedida S/D)	Yield Giving LLC	212
528762	11/11/2022	AUZOA	29 (Concedida)	Ebelco SA	212
528766	11/11/2022	PERMASURE	1 (Concedida S/D)	SAPPI LIMITED	201
528778	14/11/2022	GANADERIA.UY (mixta)	41 (Concedida S/D) y 38 (Concedida S/D)	Eduardo Blasina	174
528779	14/11/2022	MERCADO DEL POLO 100% NATURAL (mixta)	43 (Concedida), 41 (Concedida) y 35 (Concedida)	GASWIL S.A.; RODRÍGUEZ OGARA, VALENTÍN y RIVERO GARCÍA, ALVARO MIGUEL	21
528780	14/11/2022	DONATE (mixta)	42 (Concedida) y 38 (Concedida)	DECORA SRL	
528781	14/11/2022	URUGUAY CARBONO POSITIVO	41 (Concedida S/D) y 38 (Concedida S/D)	Eduardo Blasina	
528782	14/11/2022	FIND.UY	36 (Concedida S/D)	ignacio spiess	
528785	14/11/2022	SHIFTERS (mixta)	28 (Concedida) y 25 (Concedida)	Nazario Pérez Berois	222
528786	14/11/2022	LOTTO	12 (Concedida)	MONTEVERDE INVESTMENT & TRADE LTDA.	201
528788	14/11/2022	OMA (mixta)	43 (Concedida S/D)	RESTCAFE S.A.S	201
528789	14/11/2022	FILORGA NCEF	3 (Concedida S/D)	LABORATOIRES FILORGA COSMETIQUES	201

N° Exp	Resolución	Marca	Clases	Titular	Ag.
528791	14/11/2022	LA FACTURERÍA AL MEJOR ESTILO ARGENTINO (mixta)	35 (Concedida) y 30 (Concedida)	Nidia Lourdes Olivera Ustria	144
528806	04/11/2022	LOWEX	5 (Concedida S/D)	LUMINOVA PHARMA CORPORATION GmbH	212
528812	14/11/2022	BK ESTILO BUNKER (mixta)	35 (Concedida)	SOBADJIAN MORALES MARTIN	194
528813	04/11/2022	TRODER (mixta)	42 (Concedida), 35 (Concedida) y 9 (Concedida)	IDZER ADVISORS SA	216
528814	04/11/2022	LEWITT	9 (Concedida S/D)	LEWITT GmbH	212
528815	04/11/2022	(figurativa)	9 (Concedida S/D)	LEWITT GmbH	212
528816	04/11/2022	REMOCON	9 (Concedida)	Diaz de Armas, Adriana Gabriela	245
528818	04/11/2022	ITO	25 (Concedida S/D)	Carolina Rychtenberg	
528822	04/11/2022	VAXXILIVE	5 (Concedida S/D)	Boehringer Ingelheim Vetmedica GmbH	136
528823	11/11/2022	A. ALPRESTAMO MÁS CERCA DE LO QUE QUERÉS (mixta)	36 (Concedida S/D) y 35 (Concedida S/D)	Galerent SRL	144
528824	04/11/2022	VAXXINACT	5 (Concedida S/D)	Boehringer Ingelheim Vetmedica GmbH	136
528825	04/11/2022	XXI	5 (Concedida S/D)	Boehringer Ingelheim Vetmedica GmbH	136
528826	11/11/2022	RX	42 (Concedida S/D)	THE NEW ZEALAND MERINO COMPANY LIMITED	136
528827	11/11/2022	PETEMBARK	39 (Concedida S/D)	American Airlines, Inc.	136
528829	11/11/2022	MOTARRO (mixta)	16 (Concedida)	HE GUOHUA	28
528831	11/11/2022	EDUCANADA	41 (Concedida) y 35 (Concedida)	Her Majesty the Queen in right of Canada as represented by the Minister for International Trade	201
528832	11/11/2022	FXI (mixta)	25 (Concedida) y 18 (Concedida)	GRUPO FLEXI DE LEÓN, S.A.P.I. DE C.V.	181
528833	11/11/2022	FXI BY FLEXI (mixta)	25 (Concedida) y 18 (Concedida)	GRUPO FLEXI DE LEÓN, S.A.P.I. DE C.V	181
528834	04/11/2022	(figurativa)	25 (Concedida) y 18 (Concedida)	GRUPO FLEXI DE LEÓN, S.A.P.I. DE C.V	181
528835	11/11/2022	MEEDZO	5 (Concedida S/D)	LASA LABORATORIOS LLC	144

N° Exp	Resolución	Marca	Clases	Titular	Ag.
528836	14/11/2022	BA BULLPADEL ACADEMY (mixta)	41 (Concedida S/D)	AGUIRRE Y COMPAÑIA, S.A.	144
528837	14/11/2022	FXI	25 (Concedida) y 18 (Concedida)	GRUPO FLEXI DE LEÓN, S.A.P.I. DE C.V	181
528840	14/11/2022	TUDOR MASTER CHRONOMETER (mixta)	14 (Concedida S/D)	Montres Tudor SA	144
528841	11/11/2022	FXI BY FLEXI	25 (Concedida) y 18 (Concedida)	GRUPO FLEXI DE LEÓN, S.A.P.I. DE C.V	181
528842	14/11/2022	NEOMED TECNOLOGÍA MEDICA (mixta)	10 (Concedida)	NEOMED S.A.S.	194
528843	14/11/2022	DE LA CASA SIN GLUTEN (mixta)	30 (Concedida S/D)	Vanessa Berrueta	
528844	14/11/2022	CAPITAL ORIENTAL SUSTAINABLE EQUITY (mixta)	42 (Concedida), 36 (Concedida) y 35 (Concedida)	Capital Oriental SAS	186
528845	11/11/2022	BAMBOZZI	35 (Concedida), 9 (Concedida) y 7 (Concedida)	BRAZILIAN WELDING INDÚSTRIA E COMÉRCIO DE MÁQUINAS LTDA.	34
528849	11/11/2022	UNIHOUSE (mixta)	6 (Concedida)	Azzollini Construcciones SRL	220
528852	14/11/2022	ANTEAGROUP (mixta)	42 (Concedida S/D)	ANTEA IBEROLATAM, S.L.U.	216
528854	14/11/2022	WORLD IS CURVED	41 (Concedida S/D), 28 (Concedida S/D) y 25 (Concedida S/D)	Teqball Holding S.A.R.L	212
528855	11/11/2022	STYLEADAPT	21 (Concedida S/D), 11 (Concedida S/D) y 8 (Concedida S/D)	Spectrum Brands, Inc.	194
528856	14/11/2022	TEQ	41 (Concedida S/D), 28 (Concedida S/D), 25 (Concedida S/D) y 9 (Concedida S/D)	Teqball Holding S.A.R.L	212
528857	14/11/2022	(figurativa)	41 (Concedida S/D), 28 (Concedida S/D),	Teqball Holding S.A.R.L	212

N° Exp	Resolución	Marca	Clases	Titular	Ag.
			25 (Concedida S/D), 18 (Concedida S/D) y 9 (Concedida S/D)		
528858	14/11/2022	TEQBALL	45 (Concedida S/D) y 18 (Concedida S/D)	Teqball Holding S.A.R.L	212
528859	14/11/2022	MIENNIE LANNDIE (mixta)	43 (Concedida), 41 (Concedida) y 25 (Concedida)	ADRIANA BERMÚDEZ	
528861	14/11/2022	DESPERDICIØ (mixta)	41 (Concedida)	Guillermina Bauer	
528862	11/11/2022	JUMBO (mixta)	35 (Concedida)	HORST PAULMANN	94
528871	14/11/2022	DOÑA INÉS (mixta)	29 (Concedida)	RODRIGUEZ CARBAJAL MARCELA EDITH Y RODRIGUEZ CARBAJAL DANIELA INES SOCIEDAD DE HECHO	
528878	14/11/2022	ABOVE BY BASTON	3 (Concedida S/D)	BASTON INDÚSTRIA DE AEROSSÓIS LTDA.	144
528882	14/11/2022	HIOPOS	9 (Concedida S/D)	INICIATIVES DE COMUNICACIONS GEMINIS, S.L.	34
528886	14/11/2022	BRASCOLA	16 (Concedida) y 1 (Concedida)	L.H IMPORTACIONES S.A.S.	201
528887	14/11/2022	CONFICON (mixta)	37 (Concedida), 36 (Concedida) y 35 (Concedida)	GASTON MARCEL CATAUMBERT y PABLO ANDRES CATAUMBERT	219
528888	14/11/2022	FARMACITY	45 (Concedida), 43 (Concedida), 41 (Concedida), 39 (Concedida), 38 (Concedida), 32 (Concedida), 30 (Concedida), 29 (Concedida), 28 (Concedida), 26	FARMCITY S.A.	245

N° Exp	Resolución	Marca	Clases	Titular	Ag.
			(Concedida), 25 (Concedida), 24 (Concedida), 21 (Concedida), 20 (Concedida), 18 (Concedida), 16 (Concedida), 14 (Concedida), 12 (Concedida), 11 (Concedida), 10 (Concedida), 9 (Concedida), 8 (Concedida), 6 (Concedida), 4 (Concedida), 3 (Concedida) y 1 (Concedida)		
528889	14/11/2022	CW CARGO WAY (mixta)	41 (Concedida S/D) y 39 (Concedida S/D)	CARGO WAY EVENTS AND PROJECTS LOGISTICS LTDA.-ME	34
528892	14/11/2022	TEQBALL	41 (Concedida S/D)	Teqball Holding S.A.R.L	212
528893	14/11/2022	LOS VERDES	4 (Concedida S/D)	BOYERCO S.A.	
528894	14/11/2022	TEQBALL	42 (Concedida S/D), 28 (Concedida S/D), 25 (Concedida S/D) y 9 (Concedida S/D)	Teqball Holding S.A.R.L	212
528896	14/11/2022	GOL AL FUTURO (mixta)	41 (Concedida S/D)	SECRETARIA NACIONAL DEL DEPORTE	
528901	14/11/2022	BOSQUEJA MOTIVÁNDOTE A CREAR	35 (Concedida)	RUBINI VIGANÓ, MARIO JORGE	189
528905	07/11/2022	LEONARDO	30 (Concedida)	VANACITY S.A.	201
528907	16/11/2022	FONDO DE SOLIDARIDAD - MÁS	36 (Concedida)	Fondo de Solidaridad	

N° Exp	Resolución	Marca	Clases	Titular	Ag.
		EDUCACIÓN PARA MÁS JÓVENES (mixta)			
528909	21/11/2022	FDS - MÁS EDUCACIÓN PARA MÁS JÓVENES (mixta)	36 (Concedida)	Fondo de Solidaridad	
528910	14/11/2022	(figurativa)	36 (Concedida)	Fondo de Solidaridad	
528913	14/11/2022	MARY KAY ILLUMINEA DREAMS	3 (Concedida S/D)	MARY KAY INC.	144
528918	14/11/2022	TU DINERO HABLA	41 (Concedida) y 36 (Concedida)	SHELLMAN BRUMFIELD, STEPHANIE LYNN	201
528920	14/11/2022	P (mixta)	43 (Concedida S/D), 42 (Concedida S/D), 39 (Concedida S/D), 35 (Concedida S/D) y 9 (Concedida S/D)	DELIVERY HERO LATAM MARKETPLACE HOLDING S.A.	34
528921	14/11/2022	CEMEDU CENTRO MÉDICO DEL URUGUAY (mixta)	44 (Concedida)	CENTRO MEDICO DEL URUGUAY S.R.L.	201
528922	14/11/2022	MAISON MARGIELA	35 (Concedida), 25 (Concedida), 18 (Concedida), 14 (Concedida), 9 (Concedida), 4 (Concedida) y 3 (Concedida)	MARGIELA	194
528923	14/11/2022	0 1 2 3 4 5 6 7 8 9 10 11 12 13 14 15 16 17 18 19 20 21 22 23 (mixta)	35 (Concedida), 25 (Concedida), 18 (Concedida), 14 (Concedida), 9 (Concedida), 4 (Concedida) y 3 (Concedida)	MARGIELA	194
528925	14/11/2022	MM6 (mixta)	25 (Concedida), 18 (Concedida) y 14	MARGIELA	194

N° Exp	Resolución	Marca	Clases	Titular	Ag.
			(Concedida)		
528936	14/11/2022	MONTERROJO	41 (Concedida)	Juan Carlos Caceres Tamilia	101
528937	14/11/2022	CHOCOLATE	41 (Concedida)	Juan Carlos Caceres Tamilia	101
528940	14/11/2022	LA ESPUMITA	43 (Concedida)	hector daniel de leon	
528941	14/11/2022	LO DE MOLINA (mixta)	43 (Concedida), 41 (Concedida) y 16 (Concedida)	Rengache SAS	
528942	14/11/2022	CERVECERIA LA ESPUMITA	43 (Concedida)	hector daniel de leon	
528943	16/11/2022	MERCADO DE LA COSTA (mixta)	43 (Concedida)	MARTIN WLASIUK CABRERA	220
528944	14/11/2022	UEFA EURO 2024 GERMANY (mixta)	41 (Concedida S/D), 38 (Concedida S/D), 28 (Concedida S/D) y 25 (Concedida S/D)	Union des Associations Européennes de Football (UEFA)	144
528945	14/11/2022	920 920CONF	41 (Concedida S/D) y 35 (Concedida S/D)	Gustavo Armagno y Macarena Flores Weigle	
528949	07/11/2022	EL CHIRINGO JOSÉ IGNACIO (mixta)	43 (Concedida)	Diego Agustin Curi	220
528953	14/11/2022	GIRARD'S	30 (Concedida S/D)	T. Marzetti Company	194
528954	14/11/2022	CHIARAMO	14 (Concedida)	ROSARIA IORIO	144
528957	14/11/2022	GLOBALDENT (mixta)	44 (Concedida) y 35 (Concedida)	AMERICANUY SRL	201
528960	14/11/2022	GELLYCITA	29 (Concedida S/D)	CIA INDUSTRIAL DE ALIMENTAÇÃO TRADING COMPANY	34
528962	14/11/2022	BRESH (mixta)	41 (Concedida S/D)	JAIME MARTIN JAMES	34
528965	14/11/2022	NEVIOT	5 (Concedida S/D)	PROCAPS S.A.	34
528968	14/11/2022	GLUCONTIGO (mixta)	44 (Concedida S/D), 42 (Concedida S/D), 41 (Concedida S/D), 35 (Concedida S/D), 10 (Concedida S/D),	DIABETRICS HEALTHCARE S.A.S.	34

N° Exp	Resolución	Marca	Clases	Titular	Ag.
			9 (Concedida S/D) y 5 (Concedida S/D)		
528971	14/11/2022	Z ZUTRICS (mixta)	44 (Concedida S/D), 42 (Concedida S/D), 41 (Concedida S/D), 35 (Concedida S/D), 10 (Concedida S/D), 9 (Concedida S/D) y 5 (Concedida S/D)	DIABETRICS HEALTHCARE S.A.S	34
528979	14/11/2022	EXPO CANDOMBE IBEROAMERICANO	41 (Concedida)	Luis Pereyra	
528980	16/11/2022	ROPA DE CAMPO PA' CAMPAÑA (mixta)	43 (Concedida), 35 (Concedida) y 25 (Concedida)	MARIA AGUSTINA CAMEJO RODRIGUEZ	
528982	07/11/2022	ECHARLY	35 (Concedida), 21 (Concedida), 12 (Concedida), 9 (Concedida) y 7 (Concedida)	Carlos Enrique Seoane Da Fonseca	
528987	14/11/2022	MASTER DATEJUST	14 (Concedida S/D)	ROLEX SA	144
528988	15/11/2022	GOLDEN SKY	9 (Concedida S/D)	OKLO URUGUAY LTDA.	
528995	21/11/2022	MILLER GENUINE DRAFT	32 (Concedida S/D)	Coors Brewing Company	192
528996	07/11/2022	HHT	10 (Concedida S/D)	BIOSIDUS S.A.	201
528997	14/11/2022	BROMADENE	5 (Concedida S/D)	BIOSIDUS S.A.	201
528999	14/11/2022	MILLER HIGH LIFE	32 (Concedida S/D)	Coors Brewing Company	192
529002	11/11/2022	GRIN (mixta)	36 (Concedida)	FUCAC VERDE COOPERATIVA DE AHORRO Y CREDITO	201
529003	11/11/2022	MSC. MOVING THE WORLD, TOGETHER	39 (Concedida S/D)	MSC MEDITERRANEAN SHIPPING COMPANY HOLDING S.A.	192
529004	11/11/2022	REPASSA (mixta)	35 (Concedida)	LOJAS RENNER S.A.	34
529005	11/11/2022	EEC ESTUDIOS ENERGÉTICOS	42 (Concedida) y 35	Estudios Energéticos Consultores S.A.	34

N° Exp	Resolución	Marca	Clases	Titular	Ag.
		CONSULTORES	(Concedida)		
529006	11/11/2022	ESTUDIOS ENERGETICOS CONSULTORES (mixta)	42 (Concedida) y 35 (Concedida)	Estudios Energéticos Consultores S.A.	34
529007	11/11/2022	GME - GLOBAL ENERGY MARKET CONSULTANTS	42 (Concedida) y 35 (Concedida)	GME - GLOBAL ENERGY MARKET CONSULTANTS SAS	34
529008	11/11/2022	NUECA (mixta)	37 (Concedida) y 19 (Concedida)	SHAKESPEAR, LORENZO; CAROSI, JUAN GABRIEL; PITETTA, LUIS MAURICIO y CAROSI, AUGUSTO MATIAS	201
529010	11/11/2022	GME (mixta)	42 (Concedida) y 35 (Concedida)	GME - GLOBAL ENERGY MARKET CONSULTANTS SAS	34
529011	11/11/2022	(figurativa)	33 (Concedida S/D)	ALLIED DOMEQ SPIRITS & WINE LIMITED	221
529013	11/11/2022	RYBELSUS	5 (Concedida S/D)	Novo Nordisk A/S	181
529015	23/11/2022	ACADEMY FITNESS & PERFORMANCE (mixta)	44 (Concedida), 41 (Concedida) y 35 (Concedida)	ACADEMY FITNESS & PERFORMANCE S.A.D (EN FORMACION)	220
529016	11/11/2022	EL EXPENDIO	35 (Concedida)	EL EXPENDIO S.R.L.	201
529017	11/11/2022	Ñ ÑERI (mixta)	38 (Concedida)	CHAMYAN MARACHLIAN, MARTIN PAUL	201
529029	11/11/2022	CENTRUM (mixta)	5 (Concedida S/D)	GlaxoSmithKline Consumer Healthcare Holdings (US) LLC.	216
529030	11/11/2022	(figurativa)	5 (Concedida S/D)	GlaxoSmithKline Consumer Healthcare Holdings (US) LLC.	216
529037	11/11/2022	SEOULCEUTICALS	3 (Concedida)	Digital Beauty Group LLC	201
529039	14/11/2022	ADMIRE MY SKIN	5 (Concedida)	Digital Beauty Group LLC	201
529048	14/11/2022	GALACTIC BEYOND IMAGINATION (mixta)	42 (Concedida)	Enrique Silvano D'Amato Calo	194
529052	14/11/2022	ADDA (mixta)	35 (Concedida) y 25 (Concedida)	POLAKOF Y CIA S.A.	94
529057	14/11/2022	MAMMA DUCK (mixta)	25 (Concedida)	INES FLORES	
529059	14/11/2022	ALCONEXT HABLAMOS TU MISMO IDIOMA. (mixta)	35 (Concedida)	ALCON URUGUAY SAS	129

N° Exp	Resolución	Marca	Clases	Titular	Ag.
529060	14/11/2022	K2B	42 (Concedida)	Magalink S.A.	172
529063	14/11/2022	ENRAIZADA ESTUDIO TEXTIL (mixta)	24 (Concedida)	PITTA, MARTINA	189
529067	14/11/2022	RADIUS	39 (Concedida)	WTT, INC. (d/b/a Radius Travel)	94
529070	23/11/2022	COFFEE CRAS PREMIUM QUALITY (mixta)	43 (Concedida S/D)	COFFEE CRAS S.R.L.	189
529076	14/11/2022	2976	25 (Concedida S/D)	GFM GmbH Trademarks	136
529084	14/11/2022	B31 (mixta)	25 (Concedida)	CLUB BIGUA DE VILLA BIARRITZ	21
529085	23/11/2022	(figurativa)	35 (Concedida S/D)	BeiGene, Ltd.	216
529086	15/11/2022	AERO EXECUTIVE (mixta)	39 (Concedida)	Nuñez Mariano C.	144
529087	15/11/2022	AERO CARE (mixta)	39 (Concedida)	Nuñez Mariano C.	144
529098	14/11/2022	IPATI (mixta)	37 (Concedida) y 36 (Concedida)	IPATI SRL	
529109	21/11/2022	POLIRON	9 (Concedida S/D)	YOFC Poliron Indústria e Comércio de Cabos Especiais Ltda	184
529110	11/11/2022	RR ROBIN RUTH (mixta)	35 (Concedida S/D), 25 (Concedida S/D), 18 (Concedida S/D) y 9 (Concedida S/D)	BOAZ AVRAHAMI	34
529112	11/11/2022	GLOWSTICK	32 (Concedida S/D)	HACK LTD.	34
529120	11/11/2022	MIFLOW	32 (Concedida S/D)	HACK LTD.	34
529122	21/11/2022	AIRTAP (mixta)	7 (Concedida S/D)	FUJITEC CO., LTD	245
529126	21/11/2022	PIER 21	32 (Concedida S/D)	HACK LTD.	34
529137	11/11/2022	SML (mixta)	3 (Concedida)	SAMELA S.A.	34
529139	14/11/2022	PREVOR	45 (Concedida S/D), 41 (Concedida S/D), 17 (Concedida S/D), 11 (Concedida S/D), 10 (Concedida S/D), 9 (Concedida S/D), 7 (Concedida S/D),	BLOMET, Joël	34

N° Exp	Resolución	Marca	Clases	Titular	Ag.
			6 (Concedida S/D), 5 (Concedida S/D), 3 (Concedida S/D), 2 (Concedida S/D) y 1 (Concedida S/D)		
529142	11/11/2022	WAO	30 (Concedida S/D)	HELADOS ESTIU, S.A.	201
529146	21/11/2022	UNIVISA	41 (Concedida S/D), 38 (Concedida S/D), 35 (Concedida S/D) y 9 (Concedida S/D)	UNIVISION COMMUNICATIONS INC.	194
529147	14/11/2022	(figurativa)	36 (Concedida S/D)	Insigneo Financial Group, LLC.	245
529148	14/11/2022	VIX+ (mixta)	41 (Concedida S/D), 38 (Concedida S/D) y 9 (Concedida S/D)	Univision Digital IP Holdings, LLC	194
529149	11/11/2022	VIVERO (mixta)	44 (Concedida), 43 (Concedida) y 32 (Concedida)	VIVERO DEL NORTE SAS	220
529152	11/11/2022	HC3 (mixta)	7 (Concedida S/D)	JLG Industries, Inc.	194
529156	21/11/2022	XCODE CLOUD	42 (Concedida)	APPLE INC.	245
529157	21/11/2022	HERBO VIDA (mixta)	35 (Concedida S/D)	FAUSTO DE LEON	
529166	16/11/2022	(figurativa)	42 (Concedida S/D), 38 (Concedida S/D) y 9 (Concedida S/D)	TELIA COMPANY AB; TELEFÓNICA, S.A.; VODAFONE GROUP PUBLIC LIMITED COMPANY; DEUTSCHE TELEKOM AG y ORANGE SA	201
529170	21/11/2022	AGRICULTURA INTELIGENTE NATURALMENTE HOMEOPÁTICA (mixta)	5 (Concedida) y 1 (Concedida)	MENDELTIR SA	220
529177	14/11/2022	IDEARTE (mixta)	37 (Concedida) y 36 (Concedida)	Matías Guillén Fernández	220
529181	15/11/2022	BONANZA (mixta)	36 (Concedida)	Matías Guillén Fernández y Fiorella Turra Marangós	220

N° Exp	Resolución	Marca	Clases	Titular	Ag.
529197	11/11/2022	PICLEO	10 (Concedida S/D)	Bayer Aktiengesellschaft	218
529198	21/11/2022	VARINTER (mixta)	39 (Concedida) y 35 (Concedida)	VARINTER S.A.	168
529199	11/11/2022	EVERGOL	1 (Concedida S/D)	Bayer Aktiengesellschaft	218
529201	14/11/2022	DOMS (mixta)	16 (Concedida S/D)	Doms Industries Private Limited	201
529202	14/11/2022	BRIXTON (mixta)	25 (Concedida), 18 (Concedida), 14 (Concedida) y 3 (Concedida)	EMESE S.R.L.	186
529204	14/11/2022	C3 (mixta)	16 (Concedida S/D)	Doms Industries Private Limited	201
529205	14/11/2022	(figurativa)	16 (Concedida S/D)	Doms Industries Private Limited	201
529210	14/11/2022	MURATORE	20 (Concedida) y 19 (Concedida)	Zamplex SA	
529213	14/11/2022	URUFLORA (mixta)	35 (Concedida), 5 (Concedida) y 1 (Concedida)	SEMILLERIA DENUCIO LTDA.	194
529215	21/11/2022	NODO	36 (Concedida) y 35 (Concedida)	MULTERY COMPANY S.A.	229
529216	15/11/2022	DURAMÁS+ (mixta)	37 (Concedida S/D), 35 (Concedida S/D), 12 (Concedida S/D), 4 (Concedida S/D) y 1 (Concedida S/D)	DISLUB COMBUSTÍVEIS S/A	34
529217	21/11/2022	MASTER MIND	41 (Concedida), 36 (Concedida) y 35 (Concedida)	MULTERY COMPANY SA	229
529219	14/11/2022	KATIN	25 (Concedida)	Katin Partners, LLC	194
529222	15/11/2022	LUTIAN (mixta)	7 (Concedida S/D)	LUTIAN MACHINERY CO., LTD.	34
529223	15/11/2022	K (mixta)	35 (Concedida S/D), 25 (Concedida S/D), 18 (Concedida S/D)	Target Brands, Inc.	194

N° Exp	Resolución	Marca	Clases	Titular	Ag.
			y 14 (Concedida S/D)		
529224	15/11/2022	COMUNICARE APARELHOS AUDITIVOS (mixta)	44 (Concedida) y 40 (Concedida)	COMUNICARE COMERCIO DE APARELHOS AUDITIVOS LTDA	220
529225	23/11/2022	LOS SENDEROS QUESO DE PASTOR (mixta)	29 (Concedida S/D)	MARCELO MARTINO	154
529227	23/11/2022	QUESO CORONILLA	29 (Concedida S/D)	MARCELO MARTINO	154
529228	23/11/2022	QUESO ARAZÁ	29 (Concedida S/D)	MARCELO MARTINO	154
529229	21/11/2022	QPARIKQ (mixta)	44 (Concedida S/D), 16 (Concedida S/D) y 5 (Concedida S/D)	Incyte Holdings Corporation	212
529240	21/11/2022	BOWI (mixta)	25 (Concedida S/D)	Patricia Greciet	
529242	21/11/2022	RYM PROPIEDADES (mixta)	36 (Concedida S/D)	ROBERTO MARTINEZ	
529249	21/11/2022	SPIDER (mixta)	9 (Concedida S/D)	GRUPO AUTOCAR, S.A. DE C.V.	181
529255	21/11/2022	TUCSON (mixta)	9 (Concedida) y 8 (Concedida)	AMAZ TRADING INC.	118
529256	21/11/2022	RIZA	28 (Concedida)	Paz Cardoso	181
529260	21/11/2022	DALE QUE VA	41 (Concedida), 38 (Concedida) y 35 (Concedida)	Unpub S.A.	101
529261	21/11/2022	ESTUDIO RECONQUISTA GESTION EMPRESARIAL (mixta)	45 (Concedida), 36 (Concedida) y 35 (Concedida)	ER CONSULTORES S.A.S.	181
529263	21/11/2022	M MAREA (mixta)	9 (Concedida S/D)	BRANDS 2020, S.L	144
529265	21/11/2022	EDIFICIO ALTOS DE SANTIAGO DE CHILE (mixta)	37 (Concedida) y 19 (Concedida)	JUSTANY S.A.	201
529266	21/11/2022	EDIFICIO ALTOS DE SAN RAFAEL (mixta)	37 (Concedida) y 19 (Concedida)	JUSTANY S.A.	201
529267	21/11/2022	EL BESO BY ANDREA MENACHE (mixta)	35 (Concedida)	ANDREA MENACHE	194
529269	21/11/2022	RHINOMEC PARTS (mixta)	7 (Concedida S/D)	TOYAMA DO BRASIL MÁQUINAS LTDA.	201

N° Exp	Resolución	Marca	Clases	Titular	Ag.
529272	21/11/2022	PARNOR	30 (Concedida)	PARNOR S.A.	201
529275	21/11/2022	PITUSAS	30 (Concedida)	PARNOR S.A.	201
529280	21/11/2022	UKIYO	3 (Concedida)	ANDREA MENACHE	194
529284	21/11/2022	TERO	12 (Concedida S/D)	Specialized Bicycle Components, Inc.	194
529287	21/11/2022	SMART PHARMACY OLIVA (mixta)	44 (Concedida)	SWISS MEDICAL URUGUAY S.A.	245
529295	21/11/2022	H. A. FLOWERS	5 (Concedida)	LABORATORIO HOMEOALEMÁN S.R.L.	189
529296	21/11/2022	ENEMY WWW.ENEMY.COM.UY (mixta)	41 (Concedida)	SERRA, BRUNO y SERRA, FRANCO	189
529297	21/11/2022	BZ4X	12 (Concedida S/D)	TOYOTA JIDOSHA KABUSHIKI KAISHA (also trading as TOYOTA MOTOR CORPORATION)	94
529298	21/11/2022	BZ1X	12 (Concedida S/D)	TOYOTA JIDOSHA KABUSHIKI KAISHA (also trading as TOYOTA MOTOR CORPORATION)	94
529299	21/11/2022	BZ2X	12 (Concedida S/D)	TOYOTA JIDOSHA KABUSHIKI KAISHA (also trading as TOYOTA MOTOR CORPORATION)	94
529304	21/11/2022	DIESEL LIDER URUGUAY	11 (Concedida S/D) y 7 (Concedida S/D)	Diesel Lider Uruguay S.A.S.	
529306	15/11/2022	PANKO SEVENCO	30 (Concedida S/D)	joacan srl	
529307	23/11/2022	ZENNA	9 (Concedida S/D)	GONZALO MORATORIO; nicolas keuroglian y leonardo rinaldi	
529312	16/11/2022	ELECTRIFIED (mixta)	1 (Concedida S/D)	BASF SE	144
529320	16/11/2022	ENTRE TODOS (mixta)	16 (Concedida)	TECNOVIL S.A	245
529322	21/11/2022	CRTV CAMPORURAL (mixta)	41 (Concedida) y 38 (Concedida)	CAMPO RURAL SAS	201
529329	16/11/2022	MERCEDES SHOPPING (mixta)	41 (Concedida), 38 (Concedida), 36 (Concedida) y 35 (Concedida)	FILLEY S.A.	34
529330	16/11/2022	SUMMA (mixta)	6 (Concedida)	ALUMINIOS DEL URUGUAY S.A.	212

N° Exp	Resolución	Marca	Clases	Titular	Ag.
529333	16/11/2022	SUMMA (mixta)	19 (Concedida)	ALUMINIOS DEL URUGUAY S.A.	212
529335	16/11/2022	NOVELLO (mixta)	6 (Concedida)	ALUMINIOS DEL URUGUAY S.A.	212
529337	16/11/2022	NOVELLO (mixta)	19 (Concedida)	ALUMINIOS DEL URUGUAY S.A.	212
529338	16/11/2022	GALA (mixta)	6 (Concedida)	ALUMINIOS DEL URUGUAY S.A.	212
529339	16/11/2022	GALA (mixta)	19 (Concedida)	ALUMINIOS DEL URUGUAY S.A.	212
529345	16/11/2022	METTA (mixta)	6 (Concedida)	ALUMINIOS DEL URUGUAY S.A.	212
529346	21/11/2022	METTA (mixta)	19 (Concedida)	ALUMINIOS DEL URUGUAY S.A.	212
529348	21/11/2022	TERRASANA	30 (Concedida S/D) y 29 (Concedida S/D)	Fernando Baz	
529351	21/11/2022	PIZZA QUICK R DELIVERY (mixta)	43 (Concedida)	Antonio Vizintín	154
529362	21/11/2022	INVERTEC	9 (Concedida S/D)	THE LINCOLN ELECTRIC COMPANY	144
529363	21/11/2022	INVERTEC	7 (Concedida S/D)	THE LINCOLN ELECTRIC COMPANY	144
529372	21/11/2022	FARMACITY (mixta)	45 (Concedida), 44 (Concedida), 43 (Concedida), 42 (Concedida), 41 (Concedida), 39 (Concedida), 38 (Concedida), 35 (Concedida), 32 (Concedida), 30 (Concedida), 29 (Concedida), 28 (Concedida), 26 (Concedida), 25 (Concedida), 24 (Concedida), 21 (Concedida), 20 (Concedida), 18 (Concedida), 16 (Concedida)	FARMACITY S.A.	245

N° Exp	Resolución	Marca	Clases	Titular	Ag.
			(Concedida), 14 (Concedida), 12 (Concedida), 11 (Concedida), 10 (Concedida), 9 (Concedida), 8 (Concedida), 6 (Concedida), 5 (Concedida), 4 (Concedida), 3 (Concedida) y 1 (Concedida)		
529374	21/11/2022	FARMACITY (mixta)	45 (Concedida), 44 (Concedida), 43 (Concedida), 42 (Concedida), 41 (Concedida), 39 (Concedida), 38 (Concedida), 35 (Concedida), 32 (Concedida), 30 (Concedida), 29 (Concedida), 28 (Concedida), 26 (Concedida), 25 (Concedida), 24 (Concedida), 21 (Concedida), 20 (Concedida), 18 (Concedida), 16 (Concedida), 14	FARMCITY S.A.	245

N° Exp	Resolución	Marca	Clases	Titular	Ag.
			(Concedida), 12 (Concedida), 11 (Concedida), 10 (Concedida), 9 (Concedida), 8 (Concedida), 6 (Concedida), 5 (Concedida), 4 (Concedida), 3 (Concedida) y 1 (Concedida)		
529378	21/11/2022	(figurativa)	36 (Concedida)	FOUR SEASONS HOTELS (NETHERLANDS) B.V.	194
529386	21/11/2022	LASILASOL (mixta)	40 (Concedida) y 9 (Concedida)	Daiana Orgueira Hernández y Sebastián Acosta Techera	222
529390	23/11/2022	FARIZON AUTO (mixta)	37 (Concedida S/D) y 12 (Concedida S/D)	ZHEJIANG GEELY HOLDING GROUP CO., LTD.	34
529392	21/11/2022	(figurativa)	37 (Concedida S/D) y 12 (Concedida S/D)	ZHEJIANG GEELY HOLDING GROUP CO., LTD.	34
529396	23/11/2022	HOMTRUCK (mixta)	12 (Concedida S/D)	ZHEJIANG GEELY HOLDING GROUP CO., LTD.	34
529403	16/11/2022	ALIRÉ	16 (Concedida S/D)	Rafael Mediza	
529406	16/11/2022	PLASMARTE	6 (Concedida)	VEINSA LTDA.	163
529410	16/11/2022	YAY! PAPER (mixta)	35 (Concedida S/D)	ASTERIOL S.A.	201
529415	21/11/2022	GREEN DOT FLIGHT	41 (Concedida S/D) y 39 (Concedida S/D)	Carlos Gregorini	
529416	21/11/2022	TYGITUDE	5 (Concedida S/D)	F. Hoffmann-La Roche AG	201
529417	21/11/2022	BTL (mixta)	44 (Concedida S/D)	BTL ARGENTINA S.R.L.	144

N° Exp	Resolución	Marca	Clases	Titular	Ag.
			y 10 (Concedida S/D)		
529420	21/11/2022	EMSELLA	44 (Concedida S/D) y 10 (Concedida S/D)	BTL ARGENTINA S.R.L.	144
529421	21/11/2022	EMTONE	44 (Concedida S/D) y 10 (Concedida S/D)	BTL ARGENTINA S.R.L.	144
529423	21/11/2022	(figurativa)	28 (Concedida)	M&M VENTURES (2014) LIMITED	144
529424	21/11/2022	RUMMIKUB	28 (Concedida)	M&M VENTURES (2014) LIMITED	144
529425	21/11/2022	GRANDSPHERE	12 (Concedida S/D)	AUDI AG	219
529428	21/11/2022	ADDOC	42 (Concedida), 39 (Concedida) y 35 (Concedida)	ADDOC ADMINISTRACIÓN DE DOCUMENTOS S.A.	201
529430	23/11/2022	ADDOC (mixta)	42 (Concedida), 39 (Concedida) y 35 (Concedida)	ADDOC ADMINISTRACIÓN DE DOCUMENTOS S.A.	201
529432	21/11/2022	XGROUP (mixta)	36 (Concedida)	PEDRO LUIS SPORLEDER	34
529436	23/11/2022	PUEBLOMIO (mixta)	36 (Concedida)	PEDRO LUIS SPORLEDER	34
529442	21/11/2022	STORMWASH PLUS (mixta)	7 (Concedida S/D)	SAMSUNG ELECTRONICS CO., LTD.	245
529446	21/11/2022	FELMINI (mixta)	25 (Concedida S/D) y 18 (Concedida S/D)	GONZALEZ MEGRO, DÉBORA JOSELIN	189
529453	21/11/2022	PYM (mixta)	36 (Concedida)	Floder S.A.	172
529454	21/11/2022	REXONA	5 (Concedida)	Unilever Global IP Limited	136
529458	21/11/2022	SERENA MIA (mixta)	25 (Concedida S/D)	CASSARINO SILVEIRA MARIA FLORENCIA Y AGUIRRE GRAÑA MARIA NOEL	
529462	21/11/2022	VECORIS	5 (Concedida S/D)	SANOFI	144
529468	21/11/2022	REY TORO	35 (Concedida)	Rey Toro S.a.	245
529474	21/11/2022	AIWA	35 (Concedida)	AUDIO MOBILE AMERICAS, S.A.	212
529475	21/11/2022	MAGNA (mixta)	32 (Concedida S/D)	PRITTY S.A.	219

N° Exp	Resolución	Marca	Clases	Titular	Ag.
529476	21/11/2022	AIWA (mixta)	35 (Concedida)	AUDIO MOBILE AMERICAS, S.A	212
529483	23/11/2022	REINA VACA (mixta)	44 (Concedida)	Reina Vaca S.A.	245
529484	23/11/2022	LA TARAMBANA (mixta)	44 (Concedida) y 29 (Concedida)	La Tarambana S.A.R.L.	245
529518	21/11/2022	DE LA TIERRA DEL GEOPARQUE (mixta)	35 (Concedida)	INTENDENCIA DEPARTAMENTAL DE FLORES	212
529522	21/11/2022	DE LA TIERRA DEL GEOPARQUE (mixta)	39 (Concedida)	INTENDENCIA DEPARTAMENTAL DE FLORES	212
529523	21/11/2022	DE LA TIERRA DEL GEOPARQUE (mixta)	43 (Concedida)	INTENDENCIA DEPARTAMENTAL DE FLORES	212
529524	21/11/2022	DE LA TIERRA DEL GEOPARQUE (mixta)	41 (Concedida)	INTENDENCIA DEPARTAMENTAL DE FLORES	212
529530	14/11/2022	PRODEXA	5 (Concedida S/D)	LABORATORIOS IFA S.A.	212
529531	14/11/2022	PROBBA (mixta)	6 (Concedida)	ALUMINIOS DEL URUGUAY S.A.	212
529532	14/11/2022	PROBBA (mixta)	19 (Concedida)	ALUMINIOS DEL URUGUAY S.A.	212
529541	15/11/2022	ATOCARE (mixta)	5 (Concedida S/D)	BIOIBERICA, S.A.U.	94
529543	21/11/2022	CONCRETO INGENIERIA SAS	37 (Concedida S/D), 19 (Concedida S/D) y 6 (Concedida S/D)	CONCRETO INGENIERIA SAS	
529548	14/11/2022	SAKS (mixta)	36 (Concedida)	DIF Markets Agente de Valores, S.A.	94
529549	14/11/2022	SAKS (mixta)	36 (Concedida)	DIF Markets Agente de Valores, S.A.	94
529553	14/11/2022	ILLÁRY	25 (Concedida)	Virginia Cardozo Sosa	
529558	14/11/2022	VDENMENV (mixta)	9 (Concedida S/D)	Dongguan Denmen Electronic Technology Co.,LTD	34
529560	14/11/2022	LA CALITA (mixta)	19 (Concedida), 17 (Concedida), 4 (Concedida) y 1 (Concedida)	Farinelli, Agustín Alejandro	201
529561	14/11/2022	FROM (mixta)	35 (Concedida)	PUNTO S.A.	186
529566	21/11/2022	BAMBUSER (mixta)	38 (Concedida S/D), 35 (Concedida S/D)	Bambuser AB	194

N° Exp	Resolución	Marca	Clases	Titular	Ag.
			y 9 (Concedida S/D)		
529567	16/11/2022	P CENTROS PYMES (mixta)	35 (Concedida)	AGENCIA NACIONAL DE DESARROLLO (ANDE)	201
529568	16/11/2022	P CENTRO PYME (mixta)	35 (Concedida)	AGENCIA NACIONAL DE DESARROLLO (ANDE)	201
529578	21/11/2022	FIDEICOMITENTE METRO CUADRADO	37 (Concedida S/D), 36 (Concedida S/D) y 35 (Concedida S/D)	Javier Agustín Vigo Gasparotti	
529580	21/11/2022	FIDEICOMITENTE M2	37 (Concedida S/D), 36 (Concedida S/D) y 35 (Concedida S/D)	Javier Agustín Vigo Gasparotti	
529581	14/11/2022	UNIDAD DE REFERENCIA	37 (Concedida S/D), 36 (Concedida S/D) y 35 (Concedida S/D)	Javier Agustín Vigo Gasparotti	
529586	21/11/2022	ETER MAX (mixta)	42 (Concedida S/D), 41 (Concedida S/D), 35 (Concedida S/D) y 9 (Concedida S/D)	Etermax S.A.	179
529595	21/11/2022	LADY MARION (mixta)	43 (Concedida) y 30 (Concedida)	ALTGELT RICHARDSON MARION CECILIA	220
529596	21/11/2022	FILLERS (mixta)	44 (Concedida) y 3 (Concedida)	FILLERS SAS	220
529599	14/11/2022	RIO ASSET MANAGEMENT (mixta)	36 (Concedida)	GRELANA S.A.	94
529600	21/11/2022	RIO RENTAS INMOBILIARIAS ORIENTALES (mixta)	36 (Concedida)	GRELANA S.A.	94
529618	21/11/2022	OGGI PASTA E BIRRA (mixta)	43 (Concedida)	JORGE ISAÍAS DELGADO VILORIA	34
529623	21/11/2022	DEPPTO (mixta)	43 (Concedida)	Deppto.com S.A.	101
529650	21/11/2022	EL MUNDO DE LA HERRAMIENTA	35 (Concedida)	BENTANCOUR FERNANDEZ CHAVES,	201

N° Exp	Resolución	Marca	Clases	Titular	Ag.
		(mixta)		WILSON ENRIQUE	
529652	21/11/2022	DISTRIPARK MAYORISTA (mixta)	35 (Concedida)	MAREJO SAS	201
529653	21/11/2022	REUSE (mixta)	35 (Concedida S/D)	SERVICIOS INTERMEDIARIOS REUSE CHILE SpA.	94
529659	21/11/2022	RHODIUM PLASTIC SURGERY (mixta)	44 (Concedida S/D) y 3 (Concedida S/D)	Gustavo Mantrana	
529663	21/11/2022	TRIXACAR	5 (Concedida)	LABORATORIO GADOR S.A.	165
529668	21/11/2022	BONMETIQUE	3 (Concedida)	PLUMARI, VICTOR DOMINGO	194
529671	21/11/2022	CELAE CENTRO DE LOGOTERAPIA Y ANÁLISIS EXISTENCIAL (mixta)	41 (Concedida S/D)	ALEJANDRO DE BARBIERI SABATINO	94
529672	21/11/2022	DAMA HEROICA INDUMENTARIA TEXTIL (mixta)	25 (Concedida S/D)	GUERRERO MARTINEZ ALEXIS JAVIER Y JESUS IFRAN ADRIANA LUCRECIA SOCIEDAD DE HECHO	
529679	21/11/2022	RUBI (mixta)	20 (Concedida S/D), 8 (Concedida S/D) y 7 (Concedida S/D)	GERMANS BOADA, S.A.	34
529680	21/11/2022	MEDTUG	39 (Concedida S/D)	MSC MEDITERRANEAN SHIPPING COMPANY HOLDING SA	216
529685	21/11/2022	OJOS.UY (mixta)	44 (Concedida)	CHAGAS PUIG, CARLOS ANDRÉS; CORUJO CHACÓN, FEDERICO y ROSENBERG PÉREZ, NOELIA YANET	189
529687	21/11/2022	SAKAI	30 (Concedida)	DOMINAL S.A.	186
529688	21/11/2022	TOSTEX	30 (Concedida)	Tostex S.A.	201
529696	21/11/2022	MATICES	41 (Concedida)	Diego Villar	
529710	24/11/2022	CITREA	36 (Concedida)	Actian Corporation	154
529721	21/11/2022	BORGIA	43 (Concedida)	LITISOL SAS	181
529725	24/11/2022	CREDIFAMA (mixta)	36 (Concedida)	CREDIFAMA SOCIEDAD POR ACCIONES SIMPLIFICADA	181
529727	24/11/2022	CALANTIC	44 (Concedida S/D), 42 (Concedida S/D), 38 (Concedida S/D),	Bayer Aktiengesellschaft	218

N° Exp	Resolución	Marca	Clases	Titular	Ag.
			35 (Concedida S/D), 10 (Concedida S/D) y 9 (Concedida S/D)		
529728	21/11/2022	Q (mixta)	44 (Concedida S/D), 16 (Concedida S/D) y 5 (Concedida S/D)	Incyte Holdings Corporation	212
529729	24/11/2022	APPLE AIRTAG	18 (Concedida) y 14 (Concedida)	APPLE INC.	245
529731	24/11/2022	SCOTCH-BRITE	7 (Concedida S/D) y 3 (Concedida S/D)	3M Company	212
529735	24/11/2022	(figurativa)	33 (Concedida S/D) y 32 (Concedida S/D)	Zero Proof International Limited	194
529743	24/11/2022	SCAN & GO (mixta)	35 (Concedida)	HENDERSON & CIA. S.A.	181
529745	24/11/2022	METROVEINTE	41 (Concedida)	FACTORYDAY LTDA	144
529746	24/11/2022	SINGER	35 (Concedida)	KALEA S.A.	144
529761	24/11/2022	TIENDAS D1 DE TODOS! (mixta)	35 (Concedida S/D)	KOBA COLOMBIA S.A.S.	34
529762	24/11/2022	HAPPY NEST (mixta)	41 (Concedida S/D)	SILVINA MARIA GOMEZ GONZALEZ	
529765	24/11/2022	LIFEGUARD	4 (Concedida S/D)	ZF Friedrichshafen AG	216
529767	25/11/2022	MANOLO (mixta)	32 (Concedida)	AUGTAIM S.A.	34
529768	24/11/2022	EL IMPERIO SI A TODO (mixta)	43 (Concedida)	DONALD YOUNG	194
529769	24/11/2022	Z FOLD	9 (Concedida S/D)	Samsung Electronics Co., Ltd.	194
529772	24/11/2022	MULTILAN	9 (Concedida)	FURUKAWA ELECTRIC LATAM S.A	34
529773	24/11/2022	SAPUTO INGREDIENTS (mixta)	29 (Concedida S/D), 5 (Concedida S/D) y 1 (Concedida S/D)	Saputo Dairy Products Canada G.P.	194
529776	21/11/2022	BOOOM (mixta)	12 (Concedida S/D)	ZHEJIANG APOLLO MOTORCYCLE MANUFACTURER CO., LTD.	212
529777	24/11/2022	RFN (mixta)	12 (Concedida S/D)	ZHEJIANG APOLLO MOTORCYCLE MANUFACTURER CO., LTD.	212
529783	24/11/2022	FONK X MOSCA (mixta)	35 (Concedida), 28	MOSCA HNOS. S.A.	192

N° Exp	Resolución	Marca	Clases	Titular	Ag.
			(Concedida) y 16 (Concedida)		
529787	24/11/2022	MURESCA	2 (Concedida S/D)	Crisoles S.A	
529794	21/11/2022	BEAGLE (mixta)	25 (Concedida S/D)	K2 COMERCIO E INDUSTRIA LTDA	94
529795	24/11/2022	COLUMVI	5 (Concedida S/D)	F. HOFFMANN-LA ROCHE AG	201
529797	21/11/2022	LUNSUMIO	5 (Concedida S/D)	F. HOFFMANN-LA ROCHE AG	201
529799	24/11/2022	TUGALTO	5 (Concedida S/D)	NOVARTIS AG.	201
529803	21/11/2022	PREXISO (mixta)	9 (Concedida S/D)	Prexiso AG	144
529809	21/11/2022	SUNMI (mixta)	9 (Concedida S/D)	SHANGHAI SUNMI TECHNOLOGY CO., LTD.	34
529812	21/11/2022	ADPARPGA	5 (Concedida S/D)	JOHNSON & JOHNSON	194
529814	21/11/2022	CLICRURAL	39 (Concedida) y 35 (Concedida)	Rural LLC	172
529815	21/11/2022	QUANTIKGROUP (mixta)	42 (Concedida), 38 (Concedida) y 9 (Concedida)	ODANER S.A.	245
529818	23/11/2022	OTERRA	2 (Concedida S/D)	Oterra A/S	240
529819	23/11/2022	OTERRA (mixta)	2 (Concedida S/D)	Oterra A/S	240
529904	23/11/2022	EMOJITOWN	25 (Concedida)	emoji company GmbH	201
529906	23/11/2022	METAADS + (mixta)	42 (Concedida S/D) y 35 (Concedida S/D)	Federico Rodriguez	
529911	23/11/2022	82 (mixta)	5 (Concedida S/D)	Merck Sharp & Dohme B.V.	216
529914	23/11/2022	MEXORYL	3 (Concedida S/D) y 1 (Concedida S/D)	L'OREAL	144
529919	23/11/2022	CRONOS (mixta)	44 (Concedida) y 43 (Concedida)	FERIA DOMÍNGUEZ, GUILLERMO FEDERICO	194
529922	23/11/2022	LUTÁN 360° VITENO (mixta)	5 (Concedida S/D)	SOPHIA HOLDINGS, S.A. DE C.V.	34
529925	23/11/2022	AIRTAG (mixta)	42 (Concedida), 18 (Concedida), 14 (Concedida) y 9	APPLE INC.	245

N° Exp	Resolución	Marca	Clases	Titular	Ag.
			(Concedida)		
529927	23/11/2022	G-MET	5 (Concedida S/D)	PROCAPS S.A.	34
529928	23/11/2022	G-MET G-TABS	5 (Concedida S/D)	PROCAPS S.A.	34
529929	23/11/2022	APPLE AIRTAG	9 (Concedida)	APPLE INC.	245
529935	23/11/2022	PACA & NEVIO	25 (Concedida)	Fiorella D'Angelo y Maria Eugenia Mayans	244
529940	23/11/2022	BARRACAONLINE.COM (mixta)	37 (Concedida), 35 (Concedida) y 20 (Concedida)	Heber Mautone Duarte	
529943	23/11/2022	PTC THERAPEUTICS (mixta)	5 (Concedida S/D)	PTC Therapeutics, Inc.	201
529945	23/11/2022	BIOANTS	5 (Concedida S/D)	QUALAB S.A.S.	94
529946	23/11/2022	ICONEKTA (mixta)	35 (Concedida) y 9 (Concedida)	IAXGlobal Connect LLC	94
529947	23/11/2022	WELLNESS CONCEPTS LIFE (mixta)	25 (Concedida S/D)	NORITEX S.A.	34
529961	23/11/2022	IATEC	38 (Concedida), 36 (Concedida), 35 (Concedida), 28 (Concedida), 12 (Concedida) y 9 (Concedida)	INDUSTRIA AUSTRAL DE TECNOLOGIA S.A	94
529997	23/11/2022	EL VUELO DE UN ÁGUILA	35 (Concedida S/D)	Eduardo Pastorino	
530100	25/11/2022	ABU ISA	32 (Concedida)	BABASAL SRL	201
530101	25/11/2022	CLAJUS	32 (Concedida)	BABASAL SRL	201
530102	25/11/2022	MANSALVA	30 (Concedida)	CASCO BONEFON, MATIAS GONZALO	201
530106	25/11/2022	ÁNCORA HOME & DECO (mixta)	27 (Concedida S/D), 24 (Concedida S/D), 21 (Concedida S/D), 20 (Concedida S/D) y 11 (Concedida S/D)	ELEVVA LLC.	234
530110	25/11/2022	ELEVVA (mixta)	36 (Concedida S/D) y 35 (Concedida)	ELEVVA LLC	234

N° Exp	Resolución	Marca	Clases	Titular	Ag.
			S/D)		
530111	25/11/2022	DILETTO (mixta)	35 (Concedida) y 30 (Concedida)	Diletto Uruguay SAS	163
530112	25/11/2022	GOJIRAF (mixta)	45 (Concedida) y 9 (Concedida)	GOJIRAF HOLDING LIMITED	105
530118	25/11/2022	CHEBATAROFF	30 (Concedida S/D)	CHEBATAROFF ALIMENTOS LTDA	
530121	25/11/2022	EUREKA (mixta)	7 (Concedida)	Midea America Corp.	201
530123	25/11/2022	SERABRIC	5 (Concedida S/D)	SYNGENTA CROP PROTECTION AG	194
530124	25/11/2022	ROBICIA	5 (Concedida S/D)	SYNGENTA CROP PROTECTION AG	194
530137	25/11/2022	ENVICOOL (mixta)	11 (Concedida S/D)	Shenzhen Envicool Technology Co., Ltd.	34
530157	25/11/2022	LIFETYCON	42 (Concedida)	Nicolas Nimo	
530174	25/11/2022	PROQUIDENT	3 (Concedida S/D)	Proquident S.A.	144
530182	25/11/2022	REVUELE	3 (Concedida)	REVUELE Ltd.	220
530194	25/11/2022	COLOROS	9 (Concedida S/D)	GUANGDONG OPPO MOBILE TELECOMMUNICATIONS CORP., LTD.	34
530407	24/11/2022	TRUSS (mixta)	3 (Concedida S/D)	LOMA LICENCIAMIENTO DE MARCAS LTDA	34
530408	24/11/2022	TRUSS	3 (Concedida S/D)	LOMA LICENCIAMIENTO DE MARCAS LTDA	34
530452	24/11/2022	BZ (mixta)	12 (Concedida S/D)	TOYOTA JIDOSHA KABUSHIKI KAISHA (also trading as TOYOTA MOTOR CORPORATION)	94
530454	24/11/2022	(figurativa)	35 (Concedida) y 16 (Concedida)	SOFTYS S.A.	221
530478	24/11/2022	MANOS A LA BIRRA (mixta)	43 (Concedida), 41 (Concedida), 38 (Concedida) y 32 (Concedida)	FNC SOCIEDAD ANONIMA	144

RESOLUCIONES DE FRASES PUBLICITARIAS, CONCEDIDAS

N° Exp	Resolución	Marca	Clases	Titular	Ag.
479619	17/10/2022	CÓMO TE QUERÉS SENTIR?	30 (Concedida)	GRUPO BIMBO S.A.B. DE C.V.	29
479787	17/10/2022	VIAJAMOS CONTIGO	35 (Concedida)	ADMINISTRACION NACIONAL DE COMBUSTIBLES ALCOHOL Y PORTLAND	201
504475	17/10/2022	COTIDIAN, CUANDO PASA, NO PASA NADA	5 (Concedida S/D)	CMPC TISSUE S.A.	221
505438	07/10/2022	ANTEL ARENA LA EMOCIÓN ES DE TODOS (mixta)	42 (Concedida), 41 (Concedida), 38 (Concedida) y 9 (Concedida)	ADMINISTRACION NACIONAL DE TELECOMUNICACIONES (ANTEL)	144
523597	11/10/2022	GENUINA EXPRESIÓN DE LA TIERRA	33 (Concedida)	RAPPA ANIDO, MARIO RAFAEL	34
526954	07/10/2022	CON CONDONES M, VOY A LA SEGURA	10 (Concedida)	GENOMMA LAB INTERNACIONAL, S.A.B. DE C.V.	245
526957	07/10/2022	MAGIA DE VERDAD	32 (Concedida)	THE COCA-COLA COMPANY	94
526959	07/10/2022	TUKOL JARABE, UNA CUCHARADA DE ALIVIO QUE EXPULSA TODO TIPO DE TOS	5 (Concedida)	GENOMMA LAB INTERNACIONAL, S.A.B. DE C.V.	245
527111	07/10/2022	EL PRIMER ALFAJOR CON CORAZÓN DEL URUGUAY	30 (Concedida)	ZUNINO SATRAGNI, AGUSTIN	189
527122	07/10/2022	CORAZONCITOS FELICES	41 (Concedida)	ADRIANA BERMÚDEZ	
527166	07/10/2022	DÍAS MARAVILLOSOS	41 (Concedida)	ADRIANA BERMÚDEZ	
527167	07/10/2022	APRENDE, BRILLA, CRECE, RESPLANDECE	41 (Concedida)	ADRIANA BERMÚDEZ	
527168	07/10/2022	PARA TUS HIJOS E HIJAS LO MEJOR	41 (Concedida)	ADRIANA BERMÚDEZ	
527180	07/10/2022	TU LUGAR PARA COMPARTIR	41 (Concedida)	ADRIANA BERMÚDEZ	
527214	07/10/2022	CORAZONCITOS FELICES	43 (Concedida) y 25 (Concedida)	ADRIANA BERMÚDEZ	
527215	07/10/2022	DÍAS MARAVILLOSOS	43 (Concedida) y 25	ADRIANA BERMÚDEZ	

N° Exp	Resolución	Marca	Clases	Titular	Ag.
			(Concedida)		
527216	07/10/2022	BRILLA, CRECE, RESPLANDECE	43 (Concedida) y 25 (Concedida)	ADRIANA BERMÚDEZ	
527217	07/10/2022	PARA TUS HIJOS E HIJAS LO MEJOR	43 (Concedida) y 25 (Concedida)	ADRIANA BERMÚDEZ	
527221	07/10/2022	TU LUGAR PARA COMPARTIR	43 (Concedida) y 25 (Concedida)	ADRIANA BERMÚDEZ	
527579	21/11/2022	KROSER, UN MUNDO DE SOLUCIONES	35 (Concedida)	CROSER SOCIEDAD ANÓNIMA	189
527662	17/10/2022	EN EL CORAZÓN DE LOS BARRIOS	36 (Concedida) y 35 (Concedida)	DESARROLLO VERDE SAS	216
527776	24/10/2022	SABEMOS LO QUE NECESITAS	44 (Concedida) y 3 (Concedida)	Good For You SAS	144
527800	24/10/2022	PUNKTAL, LA CONFIANZA DE SIEMPRE	35 (Concedida)	PUNKTAL S.A.	189
527854	28/10/2022	DISFRUTÁ DE LO SIMPLE	35 (Concedida)	TA -TA S.A.	245
527855	28/10/2022	ES MÁS SIMPLE CUANDO TE CUESTA MENOS	35 (Concedida)	TA -TA S.A.	245
527856	28/10/2022	BAS, MÁS SIMPLE QUE UN CLICK	35 (Concedida)	TA -TA S.A.	245
527857	28/10/2022	BAS, TU MARCA URUGUAYA	35 (Concedida)	TA -TA S.A.	245
527864	28/10/2022	PUNKTAL, NOS CONOCEMOS DE TODA LA VIDA	35 (Concedida)	PUNKTAL S.A.	189
528033	28/10/2022	TU FUTURO, TU PLAN	36 (Concedida)	MAIORANO & CIA. S.B. S.A.	201
528083	03/11/2022	CICATRICURE, EYE CREAM FOR FACE	3 (Concedida)	GENOMMA LAB INTERNACIONAL, S.A.B. DE C.V.	245
528252	28/10/2022	DISFRUTEMOS ESTE MOMENTO OTRA VEZ	32 (Concedida)	THE COCA-COLA COMPANY	94
528463	31/10/2022	TODO POR ABRIR	21 (Concedida S/D) y 16 (Concedida S/D)	S. C. JOHNSON & SON, INC.	194
528708	03/11/2022	EL TERMO DE LOS URUGUAYOS	21 (Concedida)	ALEJANDRO SCHEIN	144

N° Exp	Resolución	Marca	Clases	Titular	Ag.
528847	04/11/2022	VITALFORCE FORTALECIENDO SU PRODUCCION (mixta)	1 (Concedida)	VITAL BRASIL CHEMICAL INDUSTRIA E COMERCIO PRODUTOS QUIMICOS LTDA. ME	34
529082	14/11/2022	CONSULTORIO SAGRADINI TU SONRISA ES ÚNICA (mixta)	44 (Concedida)	Edgardo Miguel Sagradini De Los Santos	
529136	21/11/2022	TWO WHEEL LIFE VIPER (mixta)	12 (Concedida S/D)	THIAGO HONORIO DE ALMEIDA	34
529569	15/11/2022	BAYGON. MATA INSECTOS Y PREOCUPACIONES	21 (Concedida S/D), 11 (Concedida S/D) y 5 (Concedida S/D)	S. C. JOHNSON & SON, INC.	194
529589	14/11/2022	GIGANTES DE LA COCINA (mixta)	35 (Concedida)	PUNKTAL S.A.	189

RESOLUCIONES DE FRASES PUBLICITARIAS, DESESTIMADAS

N° Exp	Resolución	Marca	Clases	Titular	Ag.
497808	24/11/2022	EVENTO A CIELO ABIERTO	41 (Denegada)	Joaquin Pastorino	

RESOLUCIONES DE MARCAS, DESESTIMADAS

N° Exp	Resolución	Marca	Clases	Titular	Ag.
423269	11/11/2022	CHECKPOINT	42 (Denegada S/D)	THOMSON REUTERS GLOBAL RESOURCES	20
428820	01/11/2022	PORTO BELO ALIMENTOS DEL MAR FRESHNESS & QUALITY (mixta)	29 (Denegada S/D)	MARDI S.A.	25
429239	11/11/2022	PORTOBELO	30 (Denegada) y 29 (Denegada)	DURULTE S.A.	101
442720	31/10/2022	URUGUAY ARGENTINA 2030	44 (Denegada), 39 (Denegada), 33 (Denegada), 29 (Denegada), 27 (Denegada), 18 (Denegada), 14 (Denegada) y 4	ALBERTO MARTIN SCASSO VOLONTE	

N° Exp	Resolución	Marca	Clases	Titular	Ag.
			(Denegada)		
446927	16/11/2022	URUGUAY ARGENTINA 2030	40 (Denegada), 37 (Denegada), 36 (Denegada), 34 (Denegada), 31 (Denegada), 28 (Denegada), 26 (Denegada), 24 (Denegada), 23 (Denegada), 22 (Denegada), 21 (Denegada), 20 (Denegada), 19 (Denegada), 17 (Denegada), 15 (Denegada), 13 (Denegada), 12 (Denegada), 11 (Denegada), 10 (Denegada), 8 (Denegada), 7 (Denegada), 6 (Denegada), 5 (Denegada), 2 (Denegada) y 1 (Denegada)	ALBERTO MARTIN SCASSO VOLONTE	
452229	16/11/2022	DOÑA PETRONA	30 (Denegada) y 29 (Denegada)	GABRIEL NICOLAS DEVIA IBARRA	
456183	16/11/2022	RAINBOW LOOM	28 (Denegada S/D)	CHOON'S DESIGN INC.	216
478336	24/11/2022	NORATIL	5 (Denegada)	ZODIAC INTERNATIONAL CORPORATION	18
478945	18/10/2022	CRAFT BEARINGS QUALITY	12 (Denegada S/D)	UAB CRAFT BEARINGS	180

N° Exp	Resolución	Marca	Clases	Titular	Ag.
		MINDED (mixta)	y 7 (Denegada S/D)		
479520	14/10/2022	SERRANA-SERRANA PRODUCTO URUGUAYO Y NATURAL- ARROZ BLANCO - GRANO NATURAL- LISTO EN 10 MINUTOS - RICO Y NATURAL (mixta)	30 (Denegada S/D)	NABITUR SOCIEDAD ANONIMA	129
479539	18/10/2022	EL PRECIO IRRESISTIBLE (mixta)	35 (Denegada)	NATALIA DO NACIMIENTO	193
481432	24/11/2022	OSKAR	34 (Denegada S/D)	BMJ Industries FZCO	34
487456	07/10/2022	NEBRASKA FERAL	31 (Denegada)	BcBD Medicinal S.A.	18
487807	25/10/2022	PROFARM	5 (Denegada)	AKUMS DRUGS AND PHARMACEUTICALS LTD	129
489275	17/10/2022	EL LIDER PARA TODAS LAS MARCAS	37 (Denegada S/D), 35 (Denegada S/D), 20 (Denegada S/D), 12 (Denegada S/D), 11 (Denegada S/D), 9 (Denegada S/D), 4 (Denegada S/D) y 1 (Denegada S/D)	PACCAR INC	34
489404	07/10/2022	ENJOY VACATIONS	43 (Denegada) y 41 (Denegada)	ENJOY GESTIÓN LIMITADA	94
489565	25/10/2022	DIOL	4 (Denegada S/D)	EXXON MOBIL CORPORATION	136
489832	18/10/2022	ORIGEN	41 (Denegada) y 16 (Denegada)	EDITORIAL SUDAMERICANA URUGUAYA S.A.	181
489914	18/10/2022	BOLERO	41 (Denegada S/D)	VIRGINIA LOPEZ GÓMEZ	212
489992	11/11/2022	BRIT (mixta)	31 (Denegada S/D)	VAFO Brands s.r.o.	34
490603	01/11/2022	ATLANTIZA	41 (Denegada)	HUGO MARICHAL	172
490891	14/11/2022	SPACEMEN	9 (Denegada S/D)	adp Gauselmann GmbH	34
491036	08/11/2022	ABC CHEF (mixta)	25 (Denegada S/D)	Macfisan SA.	212
491794	01/11/2022	IRACEMA	29 (Denegada S/D)	GLOBALBEV BEBIDAS E ALIMENTOS LTDA.	144

N° Exp	Resolución	Marca	Clases	Titular	Ag.
493695	07/10/2022	THE WORLD'S FAVOURITE INDIAN	35 (Denegada S/D) y 12 (Denegada S/D)	Bajaj Auto Limited	216
494273	31/10/2022	NOME (mixta)	21 (Denegada S/D), 20 (Denegada S/D), 9 (Denegada S/D) y 3 (Denegada S/D)	Guangdong Puss Investment Co., Ltd.	201
499662	31/10/2022	INVICTA	25 (Denegada)	Invicta S.p.A	34
500630	31/10/2022	ARRABALERA	32 (Denegada)	Julio Facal	172
502027	31/10/2022	SAN JOSÉ DE MAYO CAPITAL DE LA PAYADA (mixta)	41 (Denegada)	Raul Romero Lemos	
502626	17/10/2022	FARMINA CHEF DOG (mixta)	31 (Denegada)	FARMINA PET FOODS BRASIL LTDA	212
502758	19/10/2022	KORVETTO	5 (Denegada S/D)	Corteva Agriscience LLC	144
502819	25/10/2022	YERBA BRAVA (mixta)	30 (Denegada S/D)	Carlos Cisneros	
502922	26/10/2022	ESTEBAN GUERRIERI 86 (mixta)	41 (Denegada)	Oleovole S.A.	
503502	16/11/2022	CARSPOTTING	38 (Denegada S/D)	Mariana Sanguinetti	
503717	22/11/2022	CUENTOS MEDIO DE MIEDO	41 (Denegada), 38 (Denegada) y 16 (Denegada)	TERIDAL SRL	
503823	22/11/2022	LU LEGALTECH URUGUAY ASOCIACIÓN CIVIL (mixta)	45 (Concedida S/D) y 41 (Concedida S/D)	MERCEDES ARAMENDIA	
503916	22/11/2022	FREE FRAME	9 (Denegada)	OPTEC S.A.	201
504306	07/10/2022	POWER PLAYERS	41 (Denegada S/D), 28 (Denegada S/D) y 9 (Denegada S/D)	Zag America, LLC	192
504309	14/10/2022	LAXAL	5 (Denegada)	FARMACO URUGUAYO S.A.	181
504354	14/10/2022	AUTO TRADER	35 (Denegada)	EYEPEA HOLDINGS, LLC.	201
504361	14/10/2022	SOROCABANA	43 (Denegada S/D)	FEDERICO PEDRO FORNI PAYSSE	
504374	31/10/2022	PET CHEF CASERO & SALUDABLE (mixta)	31 (Denegada S/D)	PET CHEF SRL	

N° Exp	Resolución	Marca	Clases	Titular	Ag.
504417	17/10/2022	CROMANTIC (mixta)	3 (Denegada S/D)	PROSALON DISTRIBUCIONES SAS	212
504792	14/11/2022	NOKIAN FLOAT KING	12 (Denegada S/D)	NOKIAN TYRES PLC	201
504793	14/11/2022	NOKIAN MULTI KING	12 (Denegada S/D)	NOKIAN TYRES PLC	
504794	14/11/2022	NOKIAN TRACTOR KING	12 (Denegada S/D)	NOKIAN TYRES PLC	201
504796	14/11/2022	NOKIAN GROUND KING	12 (Denegada S/D)	NOKIAN TYRES PLC	201
504851	16/11/2022	CARMENSE	33 (Denegada)	CENTRO VITIS LTDA.	201
505052	16/11/2022	UNICO	5 (Denegada)	PROQUIMUR S.A.	172
505138	07/10/2022	OTROS MUNDOS OTRAS VOCES (mixta)	41 (Denegada)	PABLO MARESCA y MARIA LAURA CABRERA	220
505144	14/10/2022	EXCELLENT	37 (Denegada)	CLEMENTINO ALBERNAZ	
505224	01/11/2022	MAPEI AQUAFLEX TECHOS (mixta)	17 (Denegada), 2 (Denegada) y 1 (Denegada)	MAPEI S.p.A.	194
505231	07/10/2022	SHENGSHOU	28 (Denegada)	NICOLAS GOÑI BUKOVEC	
505278	07/10/2022	PHALCON	9 (Denegada)	Gabriel Benchoa	
505605	31/10/2022	WAY	12 (Denegada S/D)	FCA FIAT CHRYSLER AUTOMOVEIS BRASIL LTDA.	144
505906	14/10/2022	LA PRADERA GAUCHO BREEDING TRUST (mixta)	29 (Denegada)	FRIGORIFICO TACUAREMBO S.A.	201
505944	01/11/2022	CARBONERAS (mixta)	41 (Denegada)	Andrea Becerra	
506202	17/10/2022	ZARZUELA	43 (Denegada)	Virginia Lopez	212
506252	31/10/2022	SANTA BIBLIA REINA-VALERA TRADICIONAL RVT CASA PUBLICADORA PAULISTA (mixta)	16 (Denegada S/D)	CASA PUBLICADORA PAULISTA EDITORA E GRÁFICA LTDA.	34
506402	11/11/2022	SALIDA (mixta)	33 (Denegada S/D)	"MISTRAL ALKO"	94
506403	11/11/2022	SALIDA (mixta)	33 (Denegada S/D)	"MISTRAL ALKO"	94
506404	11/11/2022	SALIDA (mixta)	33 (Denegada S/D)	"MISTRAL ALKO"	94
506459	01/11/2022	INKA CHICKEN (mixta)	43 (Denegada)	WEINBERGER TORRES, ALBERTO	212
508629	19/10/2022	TOP TIER	1 (Denegada S/D)	GENERAL MOTORS LLC	136

RESOLUCIONES DE MARCAS, DESESTIMADAS (Art. 92, D. 34/999)

N° Exp	Resolución	Marca	Clases	Titular	Ag.
527236	07/10/2022	LA SOSTENIBLE (mixta)	21 (Denegada S/D)	Vanessa Rodriguez Arévalo	

RESOLUCIONES DE RENOVACIONES, DESESTIMADAS (Art. 92, D. 34/999)

N° Exp	Resolución	Marca	Clases	Titular	Ag.
495665	20/10/2022	WARING	11 (Denegada) y 7 (Denegada)	RIDEL S.A.	129
508712	14/10/2022	SUBLIME	30 (Denegada S/D) y 29 (Denegada S/D)	LEX S.A.	201
511375	14/10/2022	SIP	32 (Denegada)	EDUARDO JOSÉ PERONE PEREYRA	94
515845	14/10/2022	PRODUCTO CERTIFICADO XXXXXXXXXXXXXXXXXXXXX LATU XXXXXXXXXXXXXXXXXXXXX (mixta)	28 (Denegada), 12 (Denegada) y 11 (Denegada)	LABORATORIO TECNOLOGICO DEL URUGUAY (LATU)	220
521056	17/11/2022	RIPTIDE	35 (Concedida), 18 (Concedida), 14 (Concedida), 9 (Concedida) y 3 (Concedida S/D)	EPSZTEJN, JENNY	189
521134	17/11/2022	ALADINO FIESTAS (mixta)	43 (Concedida) y 41 (Concedida S/D)	Christian Crocco	
523334	14/10/2022	SALTO (mixta)	32 (Concedida S/D)	MARZUREL S.A.	241
523344	14/10/2022	SALTO (mixta)	32 (Concedida S/D)	MARZUREL S.A.	241
524410	10/11/2022	SASHA	32 (Anulada), 30 (Anulada) y 29 (Anulada)	CRISTALBLUE S.A.	186
525552	18/11/2022	SS SUBLIME SOLUTIONS (mixta)	38 (Concedida) y 35 (Concedida)	Luis Rinaldi	
526380	28/10/2022	POLIFILMS	37 (Concedida)	Marcelo Ferrari	

N° Exp	Resolución	Marca	Clases	Titular	Ag.
526541	25/10/2022	PROYECTARTE	40 (Concedida)	Proyectarte Corte y Grabado Laser	
526584	25/10/2022	AURORIX	5 (Concedida S/D)	MEDA AB	34
526586	25/10/2022	KAMILLOSAN	5 (Concedida)	MEDA PHARMA GMBH & CO.KG	34
528220	08/11/2022	COCOMIEL	25 (Concedida)	BURINA SOCIEDAD ANÓNIMA	189
528846	15/11/2022	MARGARD	17 (Concedida S/D)	SABIC Global Technologies B.V.	34

RESOLUCIONES DE MARCAS, DESISTIDAS (Art. 90, D. 34/999)

N° Exp	Resolución	Marca	Clases	Titular	Ag.
526038	28/10/2022	FONDOS CENTENARIO	35 (Pendiente)	CAPELAR S.A.	94
526667	28/10/2022	PUTZMEISTER	7 (Desistida S/D)	Putzmeister Engineering GmbH	221
526762	17/10/2022	PROGRAMA SEMBRANDO EMPRENEDORES	45 (Desistida), 41 (Desistida) y 35 (Desistida)	Lorena Ponce de León	212
526763	17/10/2022	(figurativa)	35 (Desistida)	Lorena Ponce de León	212
526765	17/10/2022	SEMBRANDO (mixta)	45 (Desistida) y 41 (Desistida)	Lorena Ponce de León	212
527293	07/10/2022	GOSTRONG	32 (Desistida S/D) y 29 (Desistida S/D)	Société des Produits Nestlé S.A.	156
528502	03/11/2022	ATOMSTACK (mixta)	9 (Desistida)	DISER LTDA	220

RESOLUCIONES DE MARCAS, DESISTIDAS (Art. 92, D. 34/999)

N° Exp	Resolución	Marca	Clases	Titular	Ag.
495214	11/11/2022	INMÓBILI	36 (Desistida)	FABRIZIO LÁZZARO PURRA LÓPEZ	
506819	22/11/2022	GEOPAY	42 (Desistida) y 9 (Desistida)	FIRST DATA URUGUAY S.R.L.	201
507558	14/11/2022	M-WAVE	12 (Desistida S/D), 11 (Desistida S/D) y 7 (Desistida S/D)	Messingschlager GmbH & Co. KG	94
507593	17/10/2022	APPETITE	43 (Desistida S/D)	rodrigo coitino	
507943	17/10/2022	BLACK OPAL	44 (Desistida S/D),	Black Opal Agropecuária S.A.	194

N° Exp	Resolución	Marca	Clases	Titular	Ag.
			31 (Desistida S/D) y 29 (Desistida S/D)		
507945	17/10/2022	O BLACK OPAL (mixta)	44 (Desistida S/D), 31 (Desistida S/D) y 29 (Desistida S/D)	Black Opal Agropecuária S.A.	194
516513	04/11/2022	KENDER HEMP BIOTECH (mixta)	31 (Desistida S/D)	TOFIRIX SA	
516806	11/10/2022	MALHARIA ECRAN (mixta)	25 (Desistida)	Nicolas Pablo Estefan	172
516998	28/10/2022	ESPARTA SERVICIOS (mixta)	37 (Desistida S/D)	Matias Saravia	
519052	03/10/2022	DISTRASA	39 (Desistida)	Trasa Ltda	172
519313	11/11/2022	JCR (mixta)	5 (Concedida S/D)	JCR Pharmaceuticals Co., Ltd.	212
519314	11/11/2022	(figurativa)	5 (Concedida S/D)	JCR Pharmaceuticals Co., Ltd.	212
519681	22/11/2022	CREDISOL PREPAGA	36 (Desistida)	FLODER S.A.	94
520701	25/10/2022	SEMILLAS QUINTERO (mixta)	31 (Desistida S/D)	MATEO QUINTERO	
520885	17/10/2022	EKO MUSIC (mixta)	41 (Desistida S/D)	matias gonzalez	
521434	24/10/2022	TRINCHE (mixta)	25 (Desistida)	Luis Miguel Andrada Dutra	172
522593	17/10/2022	(tridimensional)	30 (Desistida)	GRUPO BIMBO S.A.B. DE C.V.	181
522720	04/11/2022	ALMAR	39 (Desistida S/D)	Maria del Carmen Alpuin Duque	
522889	14/11/2022	ÁGATA (mixta)	35 (Desistida) y 14 (Desistida)	María Agustina González García	
524611	04/11/2022	TRAELO	1 (Desistida)	TRAELO SRL	
526405	03/10/2022	TATUCA	25 (Desistida) y 18 (Desistida)	Inciarte Gurmendez, Martin	
527834	28/10/2022	35SUR (mixta)	41 (Desistida S/D)	Aníbal Patricio Bresque	
528206	28/10/2022	UN-ATO ADAPTADOR DE TERMO ORIENTAL (mixta)	26 (Desistida), 24 (Desistida), 23 (Desistida) y 21 (Desistida S/D)	Claudia Ferreira	
528283	28/10/2022	DESPEGANDO IDEAS (mixta)	35 (Desistida S/D)	Yasmine Tejera	
528528	03/11/2022	DOÑA INES (mixta)	29 (Desistida)	Daniela Inés Rodríguez Carbajal	
529218	15/11/2022	(figurativa)	36 (Desistida S/D) y 35 (Desistida S/D)	MULTERY COMPANY SA	229

N° Exp	Resolución	Marca	Clases	Titular	Ag.
529230	15/11/2022	LUCYBEL	3 (Desistida S/D)	Valeria Alejandra Camilo Muniz	
529252	21/11/2022	FUTURE (mixta)	42 (Desistida S/D)	Ignacio Lopes	
529941	23/11/2022	RICAFLOWER	35 (Desistida)	Ricaflower	
542565	23/11/2022	GRUPO GEN URUGUAY (mixta)	39 (Desistida S/D) y 35 (Desistida S/D)	FEDERICO MONTELATICI	

RESOLUCIONES DE FRASES PUBLICITARIAS, DESISTIDAS (Art. 92, D. 34/999)

N° Exp	Resolución	Marca	Clases	Titular	Ag.
519682	22/11/2022	CREDISOL, CUANTO MÁS TE CONOCEMOS, MENOS PAGÁS	36 (Desistida)	FLODER S.A.	94

RESOLUCIONES DE RENOVACIONES, DESISTIDAS (Art. 90, D. 34/999)

N° Exp	Resolución	Marca	Clases	Titular	Ag.
402144	01/07/2009	ECO-AGUA	11 (Desistida S/D)	ECO-AGUA S.A.	130
478760	28/10/2022	SHOE EXPRESS (mixta)	35 (Pendiente S/D) y 25 (Pendiente)	URUFORUS S.A.	181
482863	14/10/2022	SESA SELECT (mixta)	35 (Denegada S/D)	RANDSTAD UK HOLDING LIMITED	165
490157	14/10/2022	AIR BP	36 (Pendiente) y 4 (Pendiente)	BP P.L.C.	18
490397	14/10/2022	DEPILISSIMA MAGLÉ (mixta)	3 (Pendiente)	DAVOS GROUP LIMITADA	101
519355	27/10/2022	METADATE	5 (Pendiente S/D)	UCB PHARMA, S.A.	34
522113	27/10/2022	EQUASYM	5 (Pendiente S/D)	SHIRE PHARMACEUTICALS IRELAND LIMITED	34
523327	13/10/2022	FRAGATA (mixta)	30 (Concedida) y 29 (Concedida)	GRUPO ÁNGEL CAMACHO, S.L.	34
526990	26/10/2022	ISOLRAP	19 (Concedida) y 17 (Concedida)	BROMYROS S.A.	201
526992	26/10/2022	ISOLTECO	19 (Concedida) y 17 (Concedida)	BROMYROS S.A.	201

RESOLUCIONES DE RENOVACIONES, DESISTIDAS (Art. 92, D. 34/999)

N° Exp	Resolución	Marca	Clases	Titular	Ag.
243961	14/10/2022	UNILOY	26 (Desistida), 25 (Desistida), 24 (Desistida), 23 (Desistida), 22 (Desistida), 21 (Desistida), 20 (Desistida), 18 (Desistida) y 16 (Desistida S/D)	UNILOY S.R.L.	18
496939	14/10/2022	RICARDITO- RICARD- CHOCOLATE POR FUERA, MERENGUE DE CORAZÓN - RICARDITO- CHOCOLATE RELLENO DE MERENGUE- RICARDITO - CHOCOLATE FILLED WITH MERINGUE - RICARD- RICARDITOCHOCOLATE RECREADO DE MERENGUE- RICARD (mixta)	30 (Desistida)	Panificadora Bimbo del Uruguay S.A.	
502750	01/11/2022	D'ALITANE ESENCIAL (mixta)	3 (Desistida)	LILIANA GRACIELA D'AGOSTINO	
503593	01/11/2022	REAL HOTELS & RESORTS (mixta)	43 (Desistida S/D)	REAL HOTELS AND RESORTS, INC.	201
507828	03/11/2022	JONTEX	10 (Desistida S/D)	Nances Holdings S.A.	165

RESOLUCIONES DE MARCAS, MODIFICADAS

N° Exp	Resolución	Marca	Clases	Notas	Ag.
469343	25/10/2022	PRINCIPAL (mixta) / Principal Financial Services, Inc.	36 (Concedida S/D)		136
476964	27/10/2022	FUNSA (mixta) / COOPERATIVA 7 DE SETIEMBRE- FUNSACOOOP	35 (Concedida), 21 (Concedida) y 12		219

N° Exp	Resolución	Marca	Clases	Notas	Ag.
			(Concedida)		
483246	14/10/2022	ANTIFLAM / LABORATORIOS DISPERT S.A.	5 (Concedida S/D)		201
512527	31/10/2022	AVEXIS (mixta) / AveXis, Inc	5 (Concedida S/D)		201
517238	07/10/2022	GENIOL / URUFARMA S.A.	5 (Pendiente)		34
519313	07/11/2022	JCR (mixta) / JCR Pharmaceuticals Co., Ltd.	5 (Concedida S/D)		212
519314	07/11/2022	(figurativa) / JCR Pharmaceuticals Co., Ltd.	5 (Concedida S/D)		212
522621	07/10/2022	HAWKS TALON GC (mixta) / NBA PROPERTIES, INC.	41 (Concedida S/D)		205
523215	22/11/2022	PETRA (mixta) / PETRA STORE SRL	25 (Concedida)		34
524944	07/10/2022	APPLE FIND MY / APPLE INC.	42 (Pendiente), 38 (Pendiente) y 9 (Pendiente)		245

RESOLUCIONES DE MARCAS, ANULADAS

N° Exp	Resolución	Marca	Clases	Notas	Ag.
411308	25/10/2022	MR. PET (mixta)	35 (Anulada) y 31 (Anulada)	ANKOLAN S.A.	101
419900	14/10/2022	IN (mixta)	43 (Anulada) y 41 (Anulada)	DOCRILAN S.A.	
428452	20/10/2022	MAXXI RUBER	2 (Anulada)	BURGOS GARCÍA, MARY BEATRIZ	144
440401	07/10/2022	MAD FOR DESIGN	42 (Anulada)	DE LEÓN LOMONACO, VALENTINA	154
441495	31/10/2022	ADELGAMATE	30 (Concedida) y 5 (Concedida)	AUGUSTO COELHO IMPORTADORES S.A.	194
459255	31/10/2022	CORAL	35 (Anulada)	GERARDO CARDONA	

RESOLUCIONES DE RENOVACIONES, MODIFICADAS

N° Exp	Resolución	Marca	Clases	Notas	Ag.
494780	08/11/2022	JOYA / NUEVOGAR S.A.	11 (Concedida S/D)		
509217	01/11/2022	WÜRTH (mixta) / WÜRTH INTERNATIONAL AG	20 (Concedida), 17 (Concedida), 16 (Concedida), 11 (Concedida), 9 (Concedida), 8 (Concedida), 7 (Concedida), 6 (Concedida), 3 (Concedida), 2 (Concedida) y 1 (Concedida)		201
514121	01/11/2022	GROFILLEX / GROFILLEX SAS	21 (Concedida S/D), 20 (Concedida S/D) y 19 (Concedida S/D)		144
520709	26/10/2022	VALLÉ EQUIPAMIENTOS ESPECIALES (mixta) / R & O VALLE S.A.	35 (Concedida), 12 (Concedida) y 10 (Concedida)		201
521846	31/10/2022	PICTET / Banque Pictet & Cie SA	36 (Concedida S/D)		201
523106	01/11/2022	MSD / Merck Sharp & Dohme Corp.	5 (Concedida)		192
523406	01/11/2022	HAN / HARTING ELECTRIC GMBH & CO. KG	9 (Concedida S/D)		34
523845	07/11/2022	SIERRA SILVER - ELABORADO DE AGAVE AZUL (mixta) / BORCO-MARKEN-IMPORT MATTHIESEN GMBH & CO. KG	33 (Concedida S/D)		219
523918	13/10/2022	BARNY'S / HENDERSON & CIA. S.A.	43 (Concedida) y 35 (Concedida S/D)		181

N° Exp	Resolución	Marca	Clases	Notas	Ag.
525747	01/11/2022	VETALGINA / INTERVET INTERNATIONAL B.V.	5 (Concedida S/D)		192

RESOLUCIONES DE RENOVACIONES, ANULADAS

N° Exp	Resolución	Marca	Clases	Notas	Ag.
433681	18/10/2022	KINESIA	5 (Anulada S/D) y 3 (Anulada S/D)	LABORATORIOS GENESSE, S.L.	220
453297	11/11/2022	ALGIOPROFEN	5 (Anulada)	LAZAR S.A.	165
457241	07/10/2022	RECUPERAT-ION	32 (Anulada S/D) y 5 (Anulada S/D)	RECUPERATION ELECTROLITOS, S.L.	34
458732	19/10/2022	BARRAS DE MAHOMA	33 (Anulada)	ESTABLECIMIENTO JUANICO S.A.	180
468041	24/11/2022	DIAGLIT URUFARMA	5 (Concedida)	URUFARMA S.A.	34
469391	25/10/2022	KONAKION	5 (Anulada S/D)	Cheplapharm Arzneimittel GmbH	180
481192	22/11/2022	RAPTOR	5 (Anulada S/D)	COMPAÑÍA CIBELES S.A.	184
494506	20/10/2022	VISOCAP	5 (Anulada S/D)	PROCAPS S.A.	34
524410	14/10/2022	SASHA	32 (Anulada), 30 (Anulada) y 29 (Anulada)	CRISTALBLUE S.A.	186

RESOLUCIONES DE RENOVACIONES, CONCEDIDAS

N° Exp	Resolución	Denominación	Clases	Titular	Vigencia	Ag.
474828	06/10/2022	OCA	30	OCA S.A.	27/06/2016	18
480241	06/10/2022	HIMALAYA HERBAL HEALTHCARE (mixta)	5 (S/D) y 30 (S/D)	HIMALAYA GLOBAL HOLDINGS LTD.	23/02/2017	144
480421	06/10/2022	URSOFALK	5 (S/D)	DR.FALK PHARMA GMBH	15/01/2017	165
480660	06/10/2022	OLD SPICE HIGH ENDURANCE	3 (S/D)	SHULTON, INC.	20/05/2017	212
480673	06/10/2022	MONTE CUDINE	2 (S/D), 3 (S/D), 4 (S/D), 21 (S/D), 29 (S/D), 30 (S/D) y 31 (S/D)	LUIS G. BONOMI & CIA. S.A.	10/02/2017	212

N° Exp	Resolución	Denominación	Clases	Titular	Vigencia	Ag.
480753	03/10/2022	TACUABÉ (mixta)	9	EDICIONES TACUABE S.R.L.	27/01/2017	179
480934	03/10/2022	B BARCEL TOREADAS (mixta)	30	GRUPO BIMBO S.A.B. DE C.V.	28/03/2017	181
480947	03/10/2022	ECOFLEX	6, 16 y 17	ALUMINIOS DEL URUGUAY S.A.	16/06/2017	212
481008	03/10/2022	LLONGUERAS (mixta)	3	LLUJO & LLONO S.L.	12/03/2017	29
481191	06/10/2022	ECOTOP	5	COMPAÑÍA CIBELES S.A.	16/04/2017	184
481214	03/10/2022	JAGUAR	14 (S/D)	MANUFACTURE DES MONTRES JAGUAR S.A.	09/05/2017	212
481223	03/10/2022	POUPURRI	21	RAUL KEMPER	28/03/2017	144
481227	03/10/2022	SPRING AGE	3	TERRY S.A.	02/04/2017	144
481228	03/10/2022	HAPPY HOUR	3	TERRY S.A.	09/04/2017	144
481229	03/10/2022	BAVIERA	32 (S/D) y 33 (S/D)	FNC SOCIEDAD ANONIMA	03/04/2017	144
481230	05/10/2022	PILSEN STOUT	32	FNC SOCIEDAD ANONIMA	25/04/2017	144
481231	05/10/2022	LACTOFAR	5	SPEFAR S.A.	09/04/2017	144
481232	27/10/2022	ADORMIN	5 (S/D)	ICLOS S.A.	17/04/2017	144
481233	05/10/2022	GOTABIOTIC	5	THE LATIN AMERICA TRADEMARK CORPORATION	29/04/2017	144
481237	05/10/2022	POEME (mixta)	3 (S/D)	L'OREAL	03/04/2017	144
481238	05/10/2022	NORMADERM	3 (S/D)	L' OREAL	03/04/2017	144
481240	28/10/2022	GARNIER TAKE CARE (mixta)	3 (S/D)	L' OREAL	25/04/2017	144
481241	05/10/2022	LINE PEEL	3 (S/D)	BIO THERM	25/04/2017	144
481242	05/10/2022	EAU LIBRE	3 (S/D)	YVES SAINT LAURENT PARFUMS	29/04/2017	144
481243	05/10/2022	FANACOLA	1 (S/D) y 16 (S/D)	FANA QUIMICA S.A.I.C.F. E I.	19/03/2017	144
481394	11/10/2022	ST DALFOUR	29 (S/D)	ST DALFOUR SAS	19/02/2017	165
482159	05/10/2022	DYNAMIC COOL	11 (S/D)	BSH HAUSGERÄTE GMBH	10/04/2017	136
482261	05/10/2022	DICUPAL	5 (S/D)	Mega Labs S.A.	24/05/2017	144
482267	28/10/2022	R ROEMMERS (mixta)	1, 3, 5, 42 (S/D) y 44	Mega Labs S.A.	05/06/2017	144
482270	05/10/2022	REBOTE	30	MARENCO S.A.	05/06/2017	144
482591	05/10/2022	HRG (mixta)	9 (S/D), 35 (S/D), 39 (S/D), 41 (S/D),	HOGG ROBINSON PLC	16/04/2017	136

N° Exp	Resolución	Denominación	Clases	Titular	Vigencia	Ag.
			42 (S/D) y 43 (S/D)			
482621	05/10/2022	YAESU	9 (S/D)	YAESU USA, INC.	03/04/2017	18
483046	05/10/2022	KNOCKANDO	33 (S/D)	JUSTERINI & BROOKS LIMITED	08/10/2017	212
483471	05/10/2022	DUAL C MIX	5 (S/D) y 32	GRUPO OMNILIFE, S.A. DE C.V.	07/09/2017	156
483575	07/10/2022	MULTIPOINT - SHIP AGENCIES NETWORK (mixta)	39	REPREMAR S.A.	29/07/2017	154
483830	05/10/2022	DIPROGENTA	5	MERCK SHARP & DOHME CORP.	26/08/2017	18
483970	05/10/2022	(figurativa)	2, 9, 14, 16, 18, 20, 24, 25 y 28	THE POLO/LAUREN COMPANY, L.P.	07/11/2017	212
484035	05/10/2022	LICHROSOLV	1 (S/D) y 9 (S/D)	MERCK KGAA	23/07/2017	129
484204	07/10/2022	(figurativa)	9 (S/D), 16 (S/D), 18 (S/D), 24 (S/D), 28 (S/D), 32 (S/D) y 35 (S/D)	LONSDALE SPORTS LIMITED	25/05/2017	165
484263	05/10/2022	MONTANA	12 (S/D)	GENERAL MOTORS LLC	05/06/2017	136
484265	05/10/2022	CAPTIVA	12	GENERAL MOTORS LLC	01/06/2017	136
484487	05/10/2022	P PERGOL (mixta)	6, 7, 35 y 37	Pergol Maquinaria S.A.	05/06/2017	101
484574	05/10/2022	DAIKYO RSV (mixta)	10 (S/D)	DAIKYO SEIKO, LTD.	28/09/2017	94
484575	05/10/2022	RSV (mixta)	10 (S/D)	DAIKYO SEIKO, LTD.	28/09/2017	94
484691	05/10/2022	ARIZU	33	FEDERACIÓN DE COOPERATIVAS VITIVINÍCOLAS ARGENTINAS COOP. LTDA.	09/06/2017	216
485274	05/10/2022	MELATOL	5	ELISIUM S.A.	02/07/2017	212
485402	03/10/2022	TURPINAL (mixta)	1 (S/D)	ITALMATCH CHEMICALS S.P.A.	24/07/2017	194
485488	18/10/2022	FILA (mixta)	25	FILA LUXEMBOURG SÀRL.	07/11/2017	156
485639	03/10/2022	ELECTROLUX	16 (S/D)	AKTIEBOLAGET ELECTROLUX	13/08/2017	201
485857	03/10/2022	(figurativa)	7 (S/D) y 12 (S/D)	THE GATES CORPORATION	20/08/2017	136
486280	03/10/2022	LUMIERE	24	INCUER S.A.	20/08/2017	18
486419	03/10/2022	FC FLUICONNECTO (mixta)	6, 17 y 35	MANULI RUBBER INDUSTRIES S.P.A.	09/08/2017	212
486665	03/10/2022	SELEGIT	5	EUROFARMA URUGUAY S.A.	10/09/2017	201

N° Exp	Resolución	Denominación	Clases	Titular	Vigencia	Ag.
487026	03/10/2022	VIRTUOSE	3 (S/D)	L'OREAL	12/10/2017	144
487105	03/10/2022	WOLF GARDEN (mixta)	7 y 8	MTD PRODUCTS INC.	26/02/2017	201
487110	14/11/2022	FUNGOSEL	5 (S/D)	GRAMON BAGO DE URUGUAY S.A.	26/08/2017	212
487215	03/10/2022	BACTROVET PLATA	5 (S/D)	KONIG URUGUAY SOCIEDAD ANONIMA	03/09/2017	129
487457	03/10/2022	FACYLDAN	29 y 30	AVEX S.A.	07/09/2017	94
487471	03/10/2022	CK (mixta)	8 (S/D), 9 (S/D), 14 (S/D), 16 (S/D), 18 (S/D), 20 (S/D), 21 (S/D), 24 (S/D), 25 (S/D), 26 (S/D), 27 (S/D), 35 (S/D) y 42 (S/D)	CALVIN KLEIN TRADEMARK TRUST	18/09/2017	136
488054	03/10/2022	JATAMANSIN	5	LABORATORIO LIBRA SOCIEDAD ANONIMA	28/09/2017	129
489961	07/10/2022	AZZARO NOW	3 (S/D)	L'OREAL	21/12/2017	144
490666	07/10/2022	(figurativa)	1 (S/D), 2 (S/D), 3 (S/D), 4 (S/D), 6 (S/D), 7 (S/D), 8 (S/D), 9 (S/D), 11 (S/D), 13 (S/D), 14 (S/D), 16 (S/D), 17 (S/D), 18 (S/D), 19 (S/D), 20 (S/D), 21 (S/D), 22 (S/D), 23 (S/D) y 27 (S/D)	SPORLOISIRS S.A.	30/06/2018	212
491310	05/10/2022	FENILAG	5	KANGSHENYUNGA S.A.	31/01/2018	136
491743	18/10/2022	I IBS.ITECH (mixta)	9	IMPACT-ITECH INC.	13/03/2018	156
492443	06/10/2022	SIGNO (mixta)	16 (S/D)	MITSUBISHI PENCIL COMPANY, LIMITED	24/08/2018	136
492451	06/10/2022	INCRESCENDO PRODUCCIONES	9	JEANNETTE EMY DREIFUS	06/03/2018	201

N° Exp	Resolución	Denominación	Clases	Titular	Vigencia	Ag.
		(mixta)		BRECHNER		
492455	06/10/2022	FITNESS	30 (S/D)	SOCIETE DES PRODUITS NESTLÉ S.A.	04/09/2018	156
492484	06/10/2022	SHIRAGIKU (mixta)	30	KABUSHIKI KAISHA MIZKAN HOLDINGS	26/03/2018	136
492501	31/10/2022	PPA (mixta)	35	PPA URUGUAY S.R.L.	28/04/2018	163
492671	06/10/2022	TRIGALIGHT	29 y 30	EL TRIGAL S.A.	11/03/2018	165
492679	06/10/2022	SOULMAX	39	FELIPE BARTOLOMÉ HUIDOBRO y CÉSAR CARLOS DE TEZANOS PINTO	14/03/2018	201
492682	06/10/2022	DEUTSCHE TELEKOM	9, 38 y 42	DEUTSCHE TELEKOM AG	12/05/2018	144
492882	14/11/2022	DD DELIA DIAZ (mixta)	3	DELIA CLARA ROISEMBERG	07/04/2018	
492911	06/10/2022	CRECIENDO	35	ADOLFO ALFREDO HAAS	24/03/2018	219
494020	31/10/2022	TERMINATOR	5 (S/D)	NIMBRA S.A.	05/06/2018	
494780	31/10/2022	JOYA	11 (S/D)	NUEVOCAR S.A.	12/05/2018	
496580	27/10/2022	FINCA SPG (mixta)	33	FINCA SPG S.A	04/11/2018	
496735	27/10/2022	NAUTIKA	9	ROLAND STANLEY STOYSICH	13/07/2018	154
497428	28/10/2022	AZABACHE (mixta)	33 (S/D), 41 (S/D) y 43 (S/D)	APARDIAN BAGHTCHEJIAN, RODOLFO	24/08/2018	245
497644	27/10/2022	AQUASOURCE	3 (S/D)	BIO THERM	07/10/2018	144
497968	05/10/2022	BERKEL (mixta)	9 (S/D)	ILLINOIS TOOL WORKS INC.	06/09/2018	34
500906	06/10/2022	KUMA	7 y 11	LEONARDO MARTIN MAMOME NUÑEZ	19/12/2021	189
501474	01/11/2022	CLINITEK ADVANTUS	10 (S/D)	SIEMENS HEALTHCARE DIAGNOSTICS INC.	21/01/2019	219
503622	25/10/2022	TUARE	30	EMPRESAS CAROZZI S.A.	15/05/2019	201
503803	25/10/2022	TOYOTA 4RUNNER (mixta)	12	TOYOTA JIDOSHA KABUSHIKI KAISHA	30/08/2019	144
503837	26/10/2022	CARDURA	1 (S/D), 2 (S/D) y 17 (S/D)	HEXION VAD B.V.	13/04/2019	165
504049	31/10/2022	CON - FIB	5	SPEFAR S.A.	28/06/2019	144

N° Exp	Resolución	Denominación	Clases	Titular	Vigencia	Ag.
505117	31/10/2022	MUNCHI'S (mixta)	30	Goyaike S.A.A.C.I. Y F	28/06/2019	144
506396	28/10/2022	NEW HOLLAND (mixta)	7 y 12	CNH INDUSTRIAL N.V.	13/07/2019	144
508066	01/11/2022	BAGO (mixta)	5 (S/D)	GRUPO EMPRESARIAL BAGO S.A.	25/09/2019	181
510662	01/11/2022	LA ABUNDANCIA	3 (S/D), 21 (S/D), 29 (S/D), 30 (S/D) y 31 (S/D)	SILCOM S.A.	09/02/2020	144
511791	01/11/2022	GINKAN BRANDT	5	BALIARDA S.A.	09/02/2020	201
511881	07/11/2022	PORTER	1 y 5 (S/D)	STOLLER ARGENTINA S.A	18/02/2020	144
512365	04/10/2022	XYZAL	5 (S/D)	GlaxoSmithkline Trading Services Limited	30/05/2020	218
513297	31/10/2022	JUANICO	33	ESTABLECIMIENTO JUANICO S.A	17/04/2020	201
513642	31/10/2022	CLÍNICA LUDERE	41 y 44	Sylvana Riba	07/05/2020	
513951	03/10/2022	LASPLACES (mixta)	35 y 44	Nelson Guarneri	28/06/2020	
514524	31/10/2022	LITE ACE (mixta)	12 (S/D)	TOYOTA JIDOSHA KABUSHIKI KAISHA	09/11/2020	144
515767	31/10/2022	SIXTYSEVEN	18, 25 y 35	AYMERICH INVER, S.L.	26/07/2020	34
516648	20/10/2022	MINGA (mixta)	35	Florencia Quagliotti y María Eugenia Esteves	18/01/2021	
516656	20/10/2022	TE DA AAALAS	32 (S/D)	RED BULL GMBH	20/12/2020	194
516727	20/10/2022	VERRUTOPIC	5	LABORATORIOS ANDROMACO S.A.	02/10/2020	165
516775	20/10/2022	MANTRA	33 (S/D)	DELTA ESTE S.A.	30/08/2020	144
516884	18/10/2022	GAES (mixta)	10	AMPLIFON IBÉRICA, S.A.	29/08/2020	201
517189	06/10/2022	M N G	25	CONSOLIDATED ARTISTS B.V.	23/10/2020	34
517900	18/10/2022	DUCKBACK	21	IRLER S.A.	20/06/2020	18
517945	25/10/2022	DALE CARNEGIE	16 (S/D)	DALE CARNEGIE & ASSOCIATES, INC.	10/10/2020	201
518493	18/10/2022	LA ABUNDANCIA CIRUELAS PRESIDENT (mixta)	29 (S/D)	SILCOM S.A.	04/12/2020	144
518544	18/10/2022	TERGEN PHARMA (mixta)	5	JOSÉ IGNACIO FERNANDEZ MARTÍNEZ	29/12/2020	181

N° Exp	Resolución	Denominación	Clases	Titular	Vigencia	Ag.
519531	28/10/2022	CERRO NEGRO	29	CIRO ALEJANDRO RODRIGUEZ HERNANDEZ	07/06/2020	
519861	27/10/2022	ENERFOS	5 y 31	NORTESUR S.A.	21/02/2021	144
520140	05/10/2022	FINAL FANTASY	9 (S/D) y 41 (S/D)	KABUSHIKI KAISHA SQUARE ENIX HOLDINGS (comerciendo tambien como Square Enix Holdings Co.,Ltd.)	11/01/2021	194
520495	01/11/2022	ANCHOR (mixta)	21 (S/D)	Anchor Consumer Products Private Limited	11/01/2021	181
521047	17/11/2022	(figurativa)	5 (S/D)	SANOFI-AVENTIS DEUTSCHLAND GMBH	28/04/2021	165
521099	17/11/2022	AVL	1 (S/D) y 10 (S/D)	AVL LIST GMBH	12/03/2021	245
521214	17/11/2022	CRESTOR	5 (S/D)	IPR PHARMACEUTICALS INC.	30/05/2021	201
521260	17/11/2022	INTUITIVE SURGICAL	10 (S/D)	Intuitive Surgical Operations, Inc.	02/08/2021	245
521421	17/11/2022	NOILLY PRAT -NP&C NOILLY PRAT - NP&C NOILLY PRAT & CIE 1, RUE NOILLY-MARSEILLAN-FRANCE- DEPOIS 1843 (mixta)	33	ETABLISSEMENTS NOILLY PRAT & CIE. SOCIÉTÉ PAR ACTIONS SIMPLIFIÉES	04/03/2021	194
521464	18/10/2022	SEALY	20 (S/D)	SEALY TECHNOLOGY LLC	22/03/2021	194
521483	24/11/2022	METEOR	3 (S/D)	LOUIS VUITTON MALLETIER	01/03/2021	245
521500	17/11/2022	CHEVROLET	37 (S/D)	GENERAL MOTORS LLC	03/03/2021	136
521525	17/11/2022	MICKEY MOUSE (mixta)	9 (S/D)	DISNEY ENTERPRISES, INC.	26/04/2021	144
521557	18/10/2022	VISUAL STUDIO	9 (S/D)	Microsoft Corporation	22/06/2021	228
521575	26/10/2022	MIRAFLEX	9	MIRAFLEX S.A.S	24/03/2021	218
521619	18/10/2022	MANZANARES UN CLASICO MUY URUGUAYO	3, 29, 30 y 33	FOOD GROUP SOLUTIONS SAS	09/02/2021	
521637	18/10/2022	3 L'IMPÉRATRICE (mixta)	3 (S/D)	DOLCE & GABBANA TRADEMARKS S.R.L.	04/03/2021	144
521701	03/10/2022	EL PALACIO DEL CAFÉ (mixta)	30 (S/D)	EL PALACIO DEL CAFÉ S.A.	28/02/2021	189
521751	03/10/2022	ALTOS DE JOSÉ IGNACIO PUNTA DEL ESTE (mixta)	36 y 37	BRATOLY S.A.	18/08/2021	94
522220	17/11/2022	STIRRUP	14 (S/D)	THE POLO/LAUREN COMPANY, L.P.	19/05/2021	212

N° Exp	Resolución	Denominación	Clases	Titular	Vigencia	Ag.
522343	17/11/2022	ARKANO SOFTWARE (mixta)	42 (S/D)	ARKANOSOFT S.A.	16/03/2021	
522518	17/11/2022	RESPONSIBLE CARE OUR COMMITMENT TO SUSTAINABILITY PROGRAMA CUIDADO RESPONSABLE DEL MEDIO AMBIENTE (mixta)	1, 35, 41 y 42	ASOCIACION DE INDUSTRIAS QUIMICAS	29/07/2021	94
523226	17/11/2022	ELEA	42 y 44	LABORATORIO ELEA PHOENIX S.A.	15/06/2021	34
523373	17/11/2022	CIMARRON (mixta)	25 (S/D)	MELOPHONE - CONSULTORES E SERVICOS, Ltd.	23/05/2021	216
523547	03/10/2022	LOVE ME BY CANNON	3	Cannon S.A.	03/05/2021	104
523818	03/10/2022	UNION FILTER	7 (S/D)	Filtromax SAS	04/05/2021	101
523917	17/11/2022	(figurativa)	5 (S/D)	BOEHRINGER INGELHEIM PHARMA G.M.B.H. & CO. KG.	27/05/2021	201
523925	07/10/2022	G - GREMEDA - COOPERATIVA MÉDICA DE ARTIGAS (mixta)	35, 39, 42 y 44	GREMEDA IAMPP SIN FINES DE LUCRO	30/09/2021	189
524006	03/10/2022	THERMAL ANTIFADE COMPLEX (mixta)	3 (S/D)	L'OREAL	03/08/2021	144
524220	17/11/2022	SANTA MARIA (mixta)	32 y 33	ivane raquel silva altesor	29/12/2020	
524226	17/11/2022	OVACIÓN	16	EL PAIS S.A.	03/06/2021	245
524266	17/11/2022	GORGA INMOBILIARIA (mixta)	35 y 36 (S/D)	MARIA IRENE GORGA AROSA	02/06/2021	194
524323	28/10/2022	RESTORADERM	3 (S/D), 5 (S/D) y 10 (S/D)	Galderma Holding S.A.	18/11/2021	245
524394	17/11/2022	CARNICENTRO	29 (S/D) y 31 (S/D)	FRIGORIFICO SAN JACINTO NIREA S.A.	23/10/2021	118
524418	03/10/2022	AZOLON	1	AGLUKON Spezialdünger GmbH & Co. KG	20/11/2021	194
524427	17/11/2022	DAYCO (mixta)	7 (S/D)	DAYCO IP HOLDINGS, LLC	05/07/2021	245
524572	03/10/2022	CEPSA (mixta)	4 (S/D)	COMPAÑIA ESPAÑOLA DE PETRÓLEOS, S.A.	31/05/2021	181
524601	03/10/2022	DAEWOO (mixta)	12	POSCO INTERNATIONAL Corporation	20/11/2021	179
524692	13/10/2022	IHT INSTANT HEAT TECHNOLOGY	9	DUNA ENTERPRISES S.L	27/05/2021	144

N° Exp	Resolución	Denominación	Clases	Titular	Vigencia	Ag.
		(mixta)				
524714	03/10/2022	CYNAR (mixta)	33 (S/D)	DAVIDE CAMPARI- MILANO N.V.	11/07/2021	34
524771	03/10/2022	CUESTA	30 (S/D) y 32	ALBA SIMONE	29/11/2021	144
524782	03/10/2022	VERA WILLIAMS CASA (mixta)	24, 25 y 35	BOGIATZIAN, OHANES	03/06/2021	189
524891	18/10/2022	URUCAFE	30	ABEMOL S.A.	14/07/2021	144
524905	17/11/2022	ALCON (mixta)	10 (S/D)	Alcon Inc.	30/09/2021	34
524924	06/10/2022	PIONEER	16	GONZALEZ JIMENEZ, EVARISTO ALFREDO y GONZALEZ JIMENEZ, VIRGINIA ELENA	08/06/2021	189
524927	06/10/2022	TDN	9, 38 y 41	TELEVISA S.A. DE C.V.	02/08/2021	212
524928	24/11/2022	ANNITA	5	ROEMMERS S.A.I.C.F.	18/10/2021	212
524929	06/10/2022	TDN (mixta)	9, 38 y 41	TELEVISA, S.A. DE C.V.	03/08/2021	212
524996	08/11/2022	ATP	41	ATP TOUR, INC.	15/06/2026	221
525081	07/10/2022	GALAX	25	AZOUBEL TEITELBAUM, NATHALIE	12/06/2021	194
525082	11/10/2022	LITTLE STONE	24 (S/D) y 25 (S/D)	JEROME LIMITADA	05/07/2021	189
525176	18/10/2022	J & J (mixta)	1 (S/D), 5 y 10 (S/D)	JOHNSON & JOHNSON	12/06/2021	194
525178	14/10/2022	J & J (mixta)	3 (S/D)	JOHNSON & JOHNSON	12/06/2021	194
525179	17/11/2022	REGAINE	3 (S/D)	JOHNSON & JOHNSON	20/06/2021	194
525228	14/10/2022	TRUMATCH	10 (S/D)	DePuy Synthes, Inc.	30/06/2021	194
525249	24/11/2022	TROP	5 (S/D)	ADAMA Agan Ltd.	12/06/2021	201
525257	18/10/2022	L JE SEME A TOUT VENT (mixta)	16 y 41	LAROUSSE, UNA SOCIEDAD POR ACCIONES SIMPLIFICADAS DE FRANCIA	25/10/2021	144
525307	14/10/2022	NOTABLE PUBLICIDAD (mixta)	35 (S/D)	STEIN LEV, FELIPE	09/07/2021	201
525310	03/10/2022	EC. BRUCHOU & ASOCIADOS	35 (S/D), 36 (S/D) y 42 (S/D)	Maria del Carmen Bruchou Hernandez	05/08/2021	
525313	03/10/2022	LEITZ	16 (S/D)	Esselte IPR AB	21/11/2021	219
525314	03/10/2022	AXA	38 (S/D)	AXA	25/06/2021	34
525317	03/10/2022	TRAUMAX	5 (S/D)	JOSÉ IGNACIO FERNANDEZ	11/07/2021	181

N° Exp	Resolución	Denominación	Clases	Titular	Vigencia	Ag.
				MARTÍNEZ		
525319	03/10/2022	BIO KUR (mixta)	5 (S/D)	SADECO S.A.	05/07/2021	218
525321	03/10/2022	DREAMGEAR (mixta)	9	dreamGEAR, LLC.	27/07/2021	218
525322	03/10/2022	TENDOACTIVE	1 (S/D) y 5 (S/D)	LABORATORIO REIG JOFRE, S.A.	21/06/2021	181
525327	03/10/2022	GALA	6 y 19	ALUMINIOS DEL URUGUAY S.A.	30/11/2021	212
525328	03/10/2022	MECAL25	6 (S/D) y 19 (S/D)	ALUMINIOS DEL URUGUAY S.A.	13/09/2021	212
525331	03/10/2022	(figurativa)	7 (S/D) y 12 (S/D)	PERKINS HOLDINGS LIMITED	20/11/2021	94
525336	20/10/2022	LOVER (mixta)	29	BALDASUR SA	12/09/2021	
525341	03/10/2022	GARNIER SKIN NATURALS (mixta)	3 (S/D)	L'OREAL	09/11/2021	144
525342	03/10/2022	(figurativa)	12 (S/D)	SAIC-GM WULING AUTOMOBILE CO., LTD	12/12/2021	34
525343	03/10/2022	EFFACLAR	3 (S/D) y 5	LA ROCHE-POSAY LABORATOIRE DERMATOLOGIQUE	14/11/2021	144
525344	06/10/2022	RENACER	33	ASESORIAS E INVERSIONES ROCA S.A.	25/07/2021	34
525345	03/10/2022	MAG.C	3 (S/D)	L'OREAL	21/11/2021	144
525347	03/10/2022	DERMO-CALM	3 (S/D)	L'OREAL	21/11/2021	144
525348	03/10/2022	MAJL.CONTRAST	3 (S/D)	L'OREAL	21/11/2021	144
525349	03/10/2022	PANORAMIC	3 (S/D)	L'OREAL	21/11/2021	144
525350	03/10/2022	BRACOL (mixta)	25	BSB PARTICIPAÇÕES LTDA.	22/10/2021	34
525351	03/10/2022	CHROMA SENSITIVE	3 (S/D)	L' OREAL	21/11/2021	144
525353	03/10/2022	YLANG	3 (S/D)	L' OREAL	24/11/2021	144
525354	03/10/2022	BARCELÓ BUSINESS TRAVEL	38 (S/D) y 39 (S/D)	BARCELO CORPORACION EMPRESARIAL S.A.	21/07/2021	216
525355	03/10/2022	AGE PERFECT	3 (S/D)	L'OREAL	26/11/2021	144
525357	27/10/2022	YVES SAINT LAURENT NU (mixta)	3 (S/D)	YVES SAINT LAURENT PARFUMS	30/11/2021	144
525359	04/10/2022	DELCO	7 (S/D), 9 (S/D), 11 (S/D) y 12 (S/D)	GENERAL MOTORS LLC	05/07/2021	136
525361	04/10/2022	3 DESEOS	29 y 30	Durulte S.A.	17/06/2021	101
525362	04/10/2022	BARCELÓ VIAJES	39 (S/D)	BARCELO CORPORACION	29/07/2021	216

N° Exp	Resolución	Denominación	Clases	Titular	Vigencia	Ag.
				EMPRESARIAL S.A.		
525364	04/10/2022	PURATE	1 (S/D)	ECOLAB INC.	17/06/2021	216
525365	04/10/2022	(figurativa)	1, 2, 4, 6, 7, 8, 9, 10, 11, 12, 14, 16, 17, 18, 21 y 28	KABUSHIKI KAISHA HITACHI SEISAKUSHO (D/B/A HITACHI,LTD)	16/07/2021	216
525370	04/10/2022	ESPACIO BA	18 y 23	INDUTOP S.A.	01/07/2021	201
525371	06/10/2022	DANIEL CASSIN	3, 14 y 18	INDUTOP S.A.	01/07/2021	201
525372	04/10/2022	REEF USA	25	Trestles IP Holdings, LLC	11/07/2021	201
525375	04/10/2022	DECORE "C" (mixta)	35	Registro Textil S.R.L.	17/06/2021	101
525376	04/10/2022	GLISERB	5 (S/D)	TAMPA S.A.	25/10/2021	186
525379	04/10/2022	VIRAZON	41, 43, 44 y 45	RAÑA RISSO, SEBASTIAN	22/06/2021	245
525380	04/10/2022	IVOMEK GOLD	5	Boehringer Ingelheim Vetmedica GmbH	03/09/2021	245
525381	04/10/2022	VILLA MARGARITA	29	PETAR LTDA.	13/07/2021	244
525383	06/10/2022	DEFINICILS (mixta)	3 (S/D)	L'OREAL	20/11/2021	144
525384	06/10/2022	LOS QUINTEROS	33	SUPERMERCADOS DISCO DEL URUGUAY S.A.	16/12/2021	165
525385	06/10/2022	AVIA	25	American Sporting Goods Corporation	12/09/2021	194
525387	06/10/2022	KEYPLEX	1	MORSE ENTERPRISES LIMITED, INC.	01/07/2021	194
525392	06/10/2022	EMANA	23 (S/D), 24 (S/D) y 25 (S/D)	RHODIA BRASIL S.A.	20/07/2021	194
525393	06/10/2022	WESTWOOD	5 (S/D)	BRISTOL-MYERS SQUIBB COMPANY	05/07/2021	194
525394	06/10/2022	QUESNACK!	29	COOPERATIVA NACIONAL DE PRODUCTORES DE LECHE (CONAPROLE)	05/12/2021	194
525395	06/10/2022	COLUMBIA PICTURES (mixta)	9 (S/D)	Columbia Pictures Industries, Inc.	05/07/2021	194
525403	06/10/2022	DOLCE	34	Netco United Pte. Ltd.	02/07/2021	201
525408	06/10/2022	EXCELLENCE. SIMPLY DELIVERED. DHL (mixta)	39 (S/D)	DHL INTERNATIONAL GMBH	09/12/2021	245
525409	06/10/2022	LABORATORIOS BUSSIE	3	LABORATORIOS BUSSIE S.A.	02/08/2021	245
525411	06/10/2022	FRESENIUS MEDICAL CARE	5 (S/D), 10 (S/D) y	FRESENIUS MEDICAL CARE	20/07/2021	34

N° Exp	Resolución	Denominación	Clases	Titular	Vigencia	Ag.
			44 (S/D)	DEUTSCHLAND GMBH		
525416	06/10/2022	(figurativa)	16 y 18	MOLAK S.A.	16/07/2021	220
525418	06/10/2022	AA.COM	35, 39, 41 y 43	American Airlines, Inc.	21/06/2021	136
525419	06/10/2022	NIVARIA	29, 30 y 31	AUGUSTO COELHO IMPORTADORES S.A.	24/06/2021	194
525421	06/10/2022	SANCHO PANZA	35	MIGUEL ANGEL GIMENEZ	10/08/2021	220
525424	06/10/2022	(figurativa)	3, 16, 35, 39 y 44	American Airlines, Inc.	21/06/2021	136
525428	06/10/2022	DOCKERS	18 (S/D)	LEVI STRAUSS & CO.	11/07/2021	194
525430	17/11/2022	BRITANNICA	9 y 42	Encyclopaedia Britannica, Inc.	11/07/2021	194
525432	06/10/2022	TREVIRA (mixta)	22 (S/D), 23 (S/D), 24 (S/D) y 25 (S/D)	TREVIRA GMBH	12/07/2021	194
525433	17/11/2022	EUROFARMA (mixta)	5	EUROFARMA LABORATÓRIOS S.A.	22/09/2021	228
525437	07/10/2022	ARTE MAYOR	33	DAGOL S.A.	07/06/2021	245
525438	07/10/2022	NARANJO AMARGO CASA DE CAMPO (mixta)	41 y 43	MARIA VIRGINIA MUJICA SILVEIRA	02/05/2021	144
525439	07/10/2022	PATRIA	5	DAGOL S.A.	12/06/2021	245
525440	07/10/2022	PORTONES SHOPPING	3, 16, 18, 20, 21, 24, 25, 28, 29, 30, 35, 36, 38, 41 y 43	HARRISON S.A.	14/10/2021	34
525441	07/10/2022	SULTANA	29 (S/D), 30 (S/D) y 31 (S/D)	DAGOL S.A.	23/05/2021	245
525442	07/10/2022	GLADIADOR	29 (S/D)	DAGOL S.A.	23/05/2021	245
525443	07/10/2022	VIVAMAX	9 y 11	A.C.I. JAPAN CORPORATION	27/12/2020	94
525447	07/10/2022	MARCASUR	16 y 35	LA CHACRA VENTURES S.A.	28/06/2021	181
525453	07/10/2022	SKYRICH (mixta)	9 (S/D)	HANGZHOU SKYRICH POWER CO., LTD.	15/09/2021	212
525458	07/10/2022	VONIC	7 y 9	FUJITEC CO., LTD	11/07/2021	245
525459	07/10/2022	ELVIC	7 y 9	FUJITEC CO., LTD	05/09/2021	245
525464	07/10/2022	BUNDY	6 (S/D) y 7 (S/D)	TI GROUP AUTOMOTIVE SYSTEMS, L.L.C.	27/05/2021	216

N° Exp	Resolución	Denominación	Clases	Titular	Vigencia	Ag.
525471	07/10/2022	CLICK.EASY	10	MERCK KGaA	25/06/2021	129
525472	07/10/2022	SEVENELLE	5	MERCK KGaA	22/06/2021	129
525474	17/11/2022	BALL PARK (mixta)	29 (S/D)	Sara Lee Foods, LLC	08/07/2021	136
525481	26/10/2022	GRANT THORNTON	35 y 36	GRANT THORNTON INTERNATIONAL LIMITED	12/07/2021	194
525482	07/10/2022	AEREOMAR	5 (S/D)	LABORATORIOS CELSIUS S.A.	26/11/2021	144
525483	07/10/2022	VITADERM	5	LABORATORIOS CELSIUS S.A.	29/11/2021	144
525484	07/10/2022	CALMASILAN	5	LABORATORIOS HAYMANN S.A.	28/11/2021	144
525485	07/10/2022	ROLAST	5	LABORATORIOS HAYMANN S.A.	13/12/2021	144
525486	07/10/2022	COVERSUN	3 (S/D)	Mega Labs S.A.	05/12/2021	144
525487	07/10/2022	PLAGREL	5	Megalabs Uruguay S.A.	26/11/2021	144
525488	07/10/2022	ACTIVIGIL GALIEN	5	Megalabs Uruguay S.A.	06/12/2021	144
525489	07/10/2022	ADAXIL PLUS	5	Megalabs Uruguay S.A.	06/12/2021	144
525490	07/10/2022	CALMOL GALIEN	5	Megalabs Uruguay S.A.	06/12/2021	144
525491	07/10/2022	CANCOR GALIEN	5	Megalabs Uruguay S.A.	06/12/2021	144
525492	07/10/2022	DOLCOX	5	Megalabs Uruguay S.A.	06/12/2021	144
525493	07/10/2022	ESOMAC GALIEN	5	Megalabs Uruguay S.A.	06/12/2021	144
525495	07/10/2022	MAXFAST	5	Megalabs Uruguay S.A.	06/12/2021	144
525496	07/10/2022	HPB GALIEN	5	Megalabs Uruguay S.A.	09/12/2021	144
525497	24/11/2022	IMUSA (mixta)	21 (S/D)	GROUPE SEB ANDEAN S.A.	21/11/2021	34
525499	07/10/2022	LATRIGIN	5	Megalabs Uruguay S.A.	09/12/2021	144
525500	07/10/2022	MAXFIL	5	Megalabs Uruguay S.A.	09/12/2021	144
525501	07/10/2022	OLPAX GALIEN	5	Megalabs Uruguay S.A.	09/12/2021	144
525502	07/10/2022	OSTEONATO	5	Megalabs Uruguay S.A.	09/12/2021	144
525503	07/10/2022	ZIPRADON GALIEN	5	Megalabs Uruguay S.A.	12/12/2021	144
525504	07/10/2022	AMINOVITAL	5 (S/D)	Megalabs Uruguay S.A.	19/12/2021	144
525518	07/10/2022	MONTESOL	5	CASTERA HNOS. S.A.	19/12/2021	245
525519	11/10/2022	CUCHARITA	30 y 31	INFUSIONES S.A.	30/09/2021	245
525526	11/10/2022	UBROLEXIN	5 (S/D)	BOEHRINGER INGELHEIM VETMEDICA GMBH	08/07/2021	201

N° Exp	Resolución	Denominación	Clases	Titular	Vigencia	Ag.
525527	11/10/2022	SLOGGI	25 (S/D)	TRIUMPH INTERTRADE AG	05/07/2021	201
525529	11/10/2022	XTRA (mixta)	3 (S/D)	Church & Dwight Co., Inc.	03/09/2021	34
525530	11/10/2022	COMPLIMENT (mixta)	25 (S/D)	TRIUMPH INTERTRADE AG	05/07/2021	201
525531	11/10/2022	AMO	25 (S/D)	TRIUMPH INTERTRADE AG	05/07/2021	201
525535	11/10/2022	ONE PUNTA DEL ESTE (mixta)	35 y 37	FELEVAI SOCIEDAD ANÓNIMA	21/11/2021	189
525537	11/10/2022	SHAFEL (mixta)	9, 19 y 20	SHAFEL S.A.	15/07/2021	194
525539	11/10/2022	BAMBU	34	BAMBU SALES INC.	30/06/2021	144
525541	11/10/2022	MATUA	33 (S/D)	Treasury Wine Estates (Matua) Limited	07/07/2021	144
525542	11/10/2022	WOLF BLASS	33 (S/D)	Bilyara Vineyards Pty Ltd	07/07/2021	144
525543	11/10/2022	BERINGER	33 (S/D)	Treasury Wine Estates Americas Company	07/07/2021	144
525544	11/10/2022	CHATEAU ST. JEAN	33 (S/D)	Treasury Wine Estates Americas Company	30/09/2021	144
525545	11/10/2022	YELLOWGLEN	33 (S/D)	Treasury Wine Estates Vintners Limited	07/10/2021	144
525546	11/10/2022	SINGLE LEAF	34	Dunhill Tobacco of London Limited	20/07/2021	194
525547	11/10/2022	BRANCA BRANCA INTERNATIONAL (mixta)	36 (S/D)	BRANCA INTERNATIONAL S.p.A.	12/08/2021	144
525548	18/10/2022	SHAREPOINT	9 (S/D), 35 (S/D), 38 (S/D) y 42 (S/D)	MICROSOFT CORPORATION	03/08/2021	228
525551	11/10/2022	CBF	7	ROLAMENTOS CBF LTDA	12/07/2021	212
525557	11/10/2022	EPOGEN	5	AMGEN INC.	16/07/2021	34
525560	11/10/2022	CALOI	12	CALOI NORTE S/A.	27/06/2021	34
525561	11/10/2022	(figurativa)	5 (S/D)	AMGEN INC.	04/07/2021	34
525566	11/10/2022	EUROPEAN	30	NUTRIGOLD URUGUAY SA	21/11/2021	233
525567	11/10/2022	NUTRIMEAT	29 y 30	NUTRIGOLD URUGUAY SA	21/11/2021	233
525572	11/10/2022	ARETHA (mixta)	25	HINCK S.A.	11/07/2021	201
525576	14/10/2022	STRUCTURA	33 (S/D)	GRUPO PEÑAFLORES S.A.	17/08/2021	94
525578	11/10/2022	USHAS	3	APRAXA S.A.	25/10/2021	201
525581	11/10/2022	DINERS CLUB INTERNATIONAL BELONG (mixta)	36 (S/D)	DINERS CLUB INTERNATIONAL LTD.	25/07/2021	194
525584	11/10/2022	PLANETA KIDS (mixta)	25	SOLEDAD AZPIROZ	05/08/2021	245
525588	17/11/2022	RENZACCI (mixta)	7	RENZACCI S.P.A. INDUSTRIA	19/12/2021	245

N° Exp	Resolución	Denominación	Clases	Titular	Vigencia	Ag.
				LAVATRICI		
525595	11/10/2022	PERFIL ESTRELLA GERDAU (mixta)	6 (S/D)	GERDAU S.A.	29/06/2021	194
525596	26/10/2022	FLORAIS DE SAINT GERMAIN (mixta)	5 (S/D)	NEIDE MARGONARI ME	20/07/2021	194
525597	11/10/2022	Q QUANTIK (mixta)	35	FRUCHEM S.A.	24/06/2021	101
525598	11/10/2022	ZAFIRO	44	RAFFO, LUIS	26/07/2021	194
525599	11/10/2022	SEDACNE	5	LABORATORIOS CAILLON & HAMONET S.A.C.I.	27/06/2021	201
525601	11/10/2022	RUPROF	5	LABORATORIOS CAILLON & HAMONET S.A.C.I.	20/07/2021	201
525602	11/10/2022	C & H (mixta)	5 (S/D)	LABORATORIOS CAILLON & HAMONET S.A.C.I.	05/07/2021	201
525603	11/10/2022	SUPERNET	38	SANTANDER INVESTMENT BANK LIMITED	26/07/2021	194
525604	11/10/2022	VIVERO LAVENDER (mixta)	44 (S/D)	GARCIA SALVO, CESAR	13/07/2021	194
525607	11/10/2022	SAP BUSINESSOBJECTS EXPLORER (mixta)	9 (S/D), 16 (S/D), 35 (S/D), 38 (S/D), 41 (S/D) y 42 (S/D)	SAP SE	08/07/2021	201
525609	12/10/2022	SAP (mixta)	9 (S/D), 16 (S/D), 41 (S/D) y 42 (S/D)	SAP SE	12/07/2021	201
525612	12/10/2022	COLGATE MAXIMA	21 (S/D)	Colgate-Palmolive Company	26/07/2021	201
525613	12/10/2022	VISUALIS (mixta)	9 (S/D), 36 (S/D), 42 (S/D) y 44 (S/D)	SANCOR COOPERATIVA DE SEGUROS LIMITADA	14/09/2021	34
525615	12/10/2022	CINEMA	20	PRONTOMETAL S.A	13/07/2021	144
525616	12/10/2022	HOLATV	41 (S/D)	HOLA, S.L.	12/08/2021	144
525617	12/10/2022	¡HOLA! TV (mixta)	41 (S/D)	HOLA, S.L.	12/08/2021	144
525618	12/10/2022	KANAFLEX (mixta)	17 (S/D)	KANAFLEX S/A INDÚSTRIA DE PLÁSTICO	05/07/2021	34
525620	17/11/2022	NEEDLE-PRO	10 (S/D)	Smiths Medical ASD Inc.	13/07/2021	201
525623	12/10/2022	EL GALGO	16 (S/D)	EL GALGO S.A.	29/06/2021	201
525625	12/10/2022	DOÑA MARÍA	29 (S/D)	MARUBY S.A.	22/10/2021	201

N° Exp	Resolución	Denominación	Clases	Titular	Vigencia	Ag.
525627	12/10/2022	DIS.P.NAT. (mixta)	29 y 30	COCCINO, CARLOS MARIA	04/10/2021	201
525633	25/10/2022	SWS SWAMI SANANDA (mixta)	3, 9, 11, 14, 16, 18, 20, 24, 25, 35, 40 y 41	ANGEL ALBERTO RINCON MAGGIOLO	25/07/2021	
525634	12/10/2022	UF6	14 (S/D)	TM Brands, LLC	19/08/2021	212
525637	12/10/2022	ENVY	3	GUCCIO GUCCI S.P.A.	09/08/2021	212
525640	13/10/2022	CHUPA CHUPS (mixta)	30 (S/D)	PERFETTI VAN MELLE S.P.A.	11/07/2021	245
525648	13/10/2022	KISBEE	12 (S/D)	PEUGEOT MOTOCYCLES	11/07/2021	94
525654	25/10/2022	CELTURA	5 (S/D)	Seqirus UK Limited	12/08/2021	194
525655	25/10/2022	FOCLIVIA	5 (S/D)	Seqirus UK Limited	08/09/2021	194
525656	13/10/2022	RODENSTOCK	9 (S/D)	RODENSTOCK GMBH	26/11/2021	194
525657	13/10/2022	EKOTRANS TRANSPORTE INTERNACIONAL (mixta)	39	EKOTRANS S.R.L.	29/06/2021	186
525663	13/10/2022	LATARJET - RUIZ LIARD	16	RUIZ LIARD, ALFREDO	18/11/2021	194
525671	13/10/2022	HALOGEN	18 y 25	DIEGO GARCIA ASIS y SERGIO GARCIA ASIS	28/06/2021	219
525678	13/10/2022	ZVA	9 (S/D) y 17 (S/D)	ELAFLEX - GUMMI EHLERS GMBH	14/10/2021	184
525680	13/10/2022	AVOCENT	9 (S/D), 41 (S/D) y 42 (S/D)	Vertiv IT Systems, Inc	28/06/2021	212
525681	13/10/2022	(figurativa)	1 (S/D), 4 (S/D), 9 (S/D), 11 (S/D), 37 (S/D), 39 (S/D), 42 (S/D) y 43 (S/D)	BP P.L.C.	26/11/2021	245
525682	13/10/2022	PIZZABATA	30	ITACARE S.A.	26/12/2021	218
525683	13/10/2022	POWER 1	4 (S/D)	CASTROL LIMITED	10/11/2021	245
525684	13/10/2022	PIZZABATTA	30	ITACARE S.A.	21/11/2021	218
525686	13/10/2022	ART&PAN	30 (S/D)	ITACARE S.A.	08/11/2021	218
525687	13/10/2022	PLAY GARDEN (mixta)	8	LAFAYETTE ZONA LIBRE, S.A.	24/11/2021	201
525688	13/10/2022	DURATOOL (mixta)	6 y 8	LAFAYETTE ZONA LIBRE, S.A.	18/11/2021	201
525689	13/10/2022	HUNTER (mixta)	7 y 8	LAFAYETTE ZONA LIBRE, S.A.	18/11/2021	201

N° Exp	Resolución	Denominación	Clases	Titular	Vigencia	Ag.
525693	13/10/2022	PAMPA	34	COMPAÑIA INDUSTRIAL DE TABACOS MONTE-PAZ S.A.	20/09/2021	245
525694	13/10/2022	CALIFORNIA (mixta)	34	COMPAÑIA INDUSTRIAL DE TABACOS MONTE-PAZ S.A.	14/07/2021	245
525695	13/10/2022	OCEAN (mixta)	34	COMPAÑIA INDUSTRIAL DE TABACOS MONTE-PAZ S.A.	08/07/2021	245
525696	13/10/2022	CRUZ DEL SUR	34	COMPAÑIA INDUSTRIAL DE TABACOS MONTE-PAZ S.A.	20/09/2021	245
525697	13/10/2022	MERIDIANO 60	34	COMPAÑIA INDUSTRIAL DE TABACOS MONTE-PAZ S.A.	20/09/2021	245
525698	13/10/2022	MADISON (mixta)	34	COMPAÑIA INDUSTRIAL DE TABACOS MONTE-PAZ S.A.	12/07/2021	245
525699	14/10/2022	NEVADA	33	COMPAÑIA INDUSTRIAL DE TABACOS MONTE-PAZ	13/08/2021	245
525702	14/10/2022	FUTURMAT	11 (S/D)	QUALITY ESPRESSO, S.A.	11/07/2021	34
525705	14/10/2022	TRANSPORTE CARRETERO (mixta)	16	FERNANDO SAPRIZA GOYRET	28/06/2021	34
525710	14/10/2022	DIGIPASS	9	ONESPAN NORTH AMERICA INC.	05/08/2021	34
525712	14/10/2022	ICAPS	5 (S/D)	Alcon Inc.	26/10/2021	34
525713	14/10/2022	TRISORB	5 (S/D)	Alcon Inc.	26/10/2021	34
525725	14/10/2022	C.O.M.S.A. (mixta)	29 y 30	GISEBA SOCIEDAD ANONIMA	11/07/2021	
525731	14/10/2022	SAÚDE (mixta)	30	SIOL ALIMENTOS LTDA.	08/11/2021	181
525732	14/10/2022	SAUDE (mixta)	29 y 30	SIOL ALIMENTOS LTDA.	01/07/2021	181
525737	18/10/2022	CARGOLINK URUGUAY	39	NELCA S.A.	11/07/2021	192
525740	18/10/2022	OPTILINE	5 (S/D), 8 (S/D) y 10 (S/D)	Elanco Tiergesundheit AG	16/09/2021	192
525741	18/10/2022	LGT (mixta)	36	LGT GRUPPE STIFTUNG	09/07/2021	201
525743	18/10/2022	LGT	36	LGT GRUPPE STIFTUNG	09/07/2021	201
525744	18/10/2022	LIECHTENSTEIN GLOBAL TRUST	36	LGT GRUPPE STIFTUNG	09/07/2021	201
525746	18/10/2022	CANARE (mixta)	9	CANARE ELECTRIC CO., LTD.	11/07/2021	201
525747	18/10/2022	VETALGINA	5 (S/D)	INTEVET INTERNATIONAL B.V.	19/09/2021	192

N° Exp	Resolución	Denominación	Clases	Titular	Vigencia	Ag.
525748	18/10/2022	METASIL	2	SWIMC LLC	11/07/2021	201
525749	19/10/2022	Z.E. (mixta)	12 (S/D)	RENAULT S.A.S.	11/07/2021	201
525750	19/10/2022	SCALIBOR	5 (S/D)	INTERVET INTERNATIONAL B.V.	29/09/2021	192
525751	19/10/2022	ALUMASA (mixta)	6 y 35	ALUMASA INDUSTRIA DE PLASTICO E ALUMINIO LTDA.	12/07/2021	201
525753	19/10/2022	PAMPLONA (mixta)	29	FRIGORIFICO RIOSULENSE S.A.	16/10/2021	201
525754	19/10/2022	LITORAL LA VIRGINIA (mixta)	30 (S/D)	CAFES LA VIRGINIA S.A.	26/10/2021	34
525757	19/10/2022	A&C ARQUITECTOS	42 (S/D)	Bruno Adrián Gonnet Malan	11/07/2021	218
525759	19/10/2022	ALICANTE	3, 5 (S/D), 29, 31 y 32	CAFES LA VIRGINIA S.A.	04/09/2021	34
525760	19/10/2022	BIPERID	5	EUROFARMA URUGUAY S.A.	11/07/2021	201
525763	19/10/2022	GAUTIER (mixta)	5	EUROFARMA URUGUAY S.A.	11/07/2021	201
525764	19/10/2022	BKM (mixta)	36	RUIZ DE OLANO, EDUARDO	08/07/2021	245
525772	19/10/2022	LA VIRGINIA (mixta)	32 y 33	CAFES LA VIRGINIA S.A.	21/11/2021	34
525775	19/10/2022	LA VIRGINIA (mixta)	5 (S/D)	CAFES LA VIRGINIA S.A.	21/11/2021	34
525776	19/10/2022	SAMSCA (TOLVAPTAN) (mixta)	5 (S/D)	OTSUKA PHARMACEUTICAL CO., LTD.	14/09/2021	34
525777	19/10/2022	SERVIPRACTIC	16	CELULOSA CAMPANA S.A.	09/08/2021	34
525779	19/10/2022	VITINA	5	MOLINOS RIO DE LA PLATA S.A.	26/12/2021	34
525785	15/11/2022	FERTIPRADO (mixta)	31 y 35	FERTIPRADO URUGUAY S.R.L.	28/07/2021	201
525789	15/11/2022	TRES CRUCES (mixta)	30	Jorge Washington Greno Peña	25/10/2021	222
525793	19/10/2022	HONORA (mixta)	30 (S/D)	COMPAÑIA NACIONAL DE LEVADURAS LEVAPAN S.A.	03/08/2021	216
525801	19/10/2022	INOAR (mixta)	3 (S/D)	INOAR COMÉRCIO DE COSMÉTICOS LTDA - ME	01/07/2021	94
525803	19/10/2022	POPURRÍ (mixta)	41	GABRIELA PEREZ DEL CASTILLO	08/07/2021	181
525815	19/10/2022	CITRÓNGE	33 (S/D)	Bacardi Martini Patron International GmbH	05/10/2021	194
525819	19/10/2022	COPPETTI	9, 16 y 41	CARLOS PABLO COPPETTI ABADIE	30/06/2021	212
525826	19/10/2022	(figurativa)	31 y 35	INSTITUTO NACIONAL DE	20/12/2021	34

N° Exp	Resolución	Denominación	Clases	Titular	Vigencia	Ag.
				INVESTIGACION AGROPECUARIA (INIA)		
525827	19/10/2022	RIGEL	31	INSTITUTO NACIONAL DE INVESTIGACION AGROPECUARIA (INIA)	20/12/2021	34
525837	14/10/2022	MIGRATAPSIN	5	LABORATORIO MAVER S.A.	11/07/2021	201
525838	14/10/2022	DOLORUB	5	LABORATORIO MAVER S.A.	11/07/2021	201
525839	14/10/2022	FIBRASOL	5	LABORATORIO MAVER S.A.	09/11/2021	201
525841	14/10/2022	DOMUSLIFT	7	IGV GROUP S.P.A.	13/07/2021	201
525843	14/10/2022	ALTAMA	29, 30 y 31	ALTAMA S.A.	25/10/2021	201
525845	14/10/2022	MOSKOVSKAYA (mixta)	32 (S/D), 33 (S/D) y 35 (S/D)	Amber IP Brands Sàrl	03/08/2021	181
525846	14/10/2022	MOSKOVSKAYA	32 (S/D), 33 (S/D) y 35 (S/D)	Amber IP Brands Sàrl	03/08/2021	181
525847	14/10/2022	STOLICHNAYA (mixta)	32 (S/D), 33 (S/D) y 35 (S/D)	ZHS IP Americas Sàrl	03/08/2021	181
525848	14/10/2022	STOLICHNAYA	32 (S/D), 33 (S/D) y 35 (S/D)	ZHS IP Americas Sàrl	03/08/2021	181
525850	14/10/2022	SHREK FOREVER AFTER	9 y 28	DreamWorks Animation L.L.C.	19/07/2021	94
525855	14/10/2022	PLOTT (mixta)	37	PABLO PEREYRA	02/12/2021	144
525863	17/11/2022	VICTORIA'S SECRET VERY SEXY FOR HIM	3 (S/D)	Victoria's Secret Stores Brand Management, LLC.	01/07/2021	144
525864	17/11/2022	VICTORIA'S SECRET VERY SEXY FOR HER	3 (S/D)	VICTORIA'S SECRET STORES BRAND MANAGEMENT, LLC.	01/07/2021	144
525865	17/11/2022	SEXY LITTLE THINGS	3 (S/D)	VICTORIA'S SECRET STORES BRAND MANAGEMENT, LLC.	01/07/2021	144
525867	17/11/2022	DREAM ANGELS WISH	3 (S/D)	VICTORIA'S SECRET STORES BRAND MANAGEMENT, LLC.	01/07/2021	144
525868	14/10/2022	(figurativa)	3, 5 y 16	Gramón Bagó de Uruguay S.A.	08/07/2021	181
525869	17/11/2022	DREAM ANGELS HEAVENLY	3 (S/D)	VICTORIA'S SECRET STORES BRAND MANAGEMENT, LLC.	01/07/2021	144

N° Exp	Resolución	Denominación	Clases	Titular	Vigencia	Ag.
525878	14/10/2022	SIL-X (mixta)	4 (S/D)	CHEVRON INTELLECTUAL PROPERTY LLC	05/09/2021	144
525879	14/10/2022	DACOTA (mixta)	24	CIA. FIAÇÃO E TECIDOS GUARATINGUETÁ	03/01/2021	144
525880	14/10/2022	ROCKET	12	Osvaldo Gago Valles	30/05/2021	222
525881	14/10/2022	URUCITRUS	31	URUD'OR S.A.	06/12/2021	245
525883	14/10/2022	(figurativa)	12 y 37	PIRELLI TYRE S.P.A.	10/08/2021	192
525889	14/10/2022	RUSTY	12	Binze S.A.	17/06/2021	222
525894	14/10/2022	MR. CHLOR (mixta)	1	LAS MALVINAS S.R.L.	02/01/2021	94
525895	14/10/2022	MADO ORIGINALS	3 (S/D)	MARIANNA LUKETICH	05/07/2021	101
525896	14/10/2022	MOLINO CAÑUELAS (mixta)	29 y 30	MOLINO CAÑUELAS S.A.C.I.F.I.A.	02/07/2021	192
525900	28/10/2022	FEBULOX	5	LAZAR S.A.	12/08/2021	165
525902	28/10/2022	NEBLIC	5	LAZAR S.A.	05/09/2021	165
525903	28/10/2022	URUGEN	42 y 44	LAZAR S.A.	23/08/2021	165
525908	14/10/2022	FOXETIN	5	LABORATORIO GADOR S.A.	06/08/2021	165
525909	14/10/2022	GADOXIFEN	5	LABORATORIO GADOR S.A.	13/08/2021	165
525911	14/10/2022	RADESCA	9, 37 y 42	JUAN J. RADESCA S.A.	28/11/2021	165
525913	14/10/2022	RADESCA (mixta)	9 y 42	JUAN J. RADESCA S.A.	28/11/2021	165
525918	31/10/2022	HAIG'S WHISKY (mixta)	33 (S/D)	DIAGEO BRANDS B.V.	05/07/2021	212
525921	14/10/2022	MERCK	35, 42, 43 y 44	MERCK KGaA	05/07/2021	129
525922	14/10/2022	POLO OESTE (mixta)	35, 36 y 39	DORALINE S.A.	06/10/2021	34
525926	14/10/2022	OSIRIS	33	ANTIGUA BODEGA STAGNARI S.A.	07/07/2021	189
525927	14/10/2022	METVISA	7 (S/D)	METALÚRGICA VISA LTDA.	10/08/2021	34
525928	17/11/2022	NUTRITERNERA	31 (S/D)	BARRACA JORGE WALTER ERRO S.A.	04/10/2021	34
525929	17/11/2022	KELLER (mixta)	31 (S/D)	LODYTEX S.A.	31/10/2021	34
525930	17/11/2022	CRIZANZAS CASERAS (mixta)	31 (S/D)	LODYTEX S.A.	31/10/2021	34
525931	09/11/2022	OKTOBERFEST	41	DEUTSCHER RUDERVEREIN MONTEVIDEO/CLUB ALEMAN DE REMO MONTEVIDEO	21/07/2021	186

N° Exp	Resolución	Denominación	Clases	Titular	Vigencia	Ag.
525936	14/10/2022	CREMODAN	1 (S/D)	DANISCO A/S:	05/09/2021	165
525939	14/10/2022	(figurativa)	37	DONGFENG MOTOR CORPORATION	04/01/2022	34
525941	14/10/2022	DFM	37	DONGFENG MOTOR CORPORATION	04/01/2022	34
525942	14/10/2022	TENCEL	22	LENZING AKTIENGESELLSCHAFT	21/11/2021	94
525944	14/10/2022	GOLF	12	VOLKSWAGEN AKTIENGESELLSCHAFT	06/08/2021	34
525946	14/10/2022	BVLGARI (mixta)	41, 42, 43 y 44	BULGARI S.P.A.	29/11/2021	212
525948	14/10/2022	TENCEL	24	LENZING AKTIENGESELLSCHAFT	05/09/2021	94
525949	14/10/2022	CHATEAU FOMBRAUGE	33 (S/D)	CHATEAU FOMBRAUGE	03/08/2021	216
525950	14/10/2022	CHATEAU PAPE CLEMENT	33	CHATEAU PAPE CLEMENT	03/08/2021	216
525951	14/10/2022	LE CLEMENTIN DU PAPE CLEMENT	33 (S/D)	CHATEAU PAPE CLEMENT	03/08/2021	216
525952	14/10/2022	DONGFENG	37	DONGFENG MOTOR CORPORATION	04/01/2022	34
525953	17/10/2022	BEN 10	3 (S/D), 14, 20, 21, 24, 29, 30 y 32	THE CARTOON NETWORK, INC.	21/07/2021	216
525955	17/10/2022	CARTOON NETWORK (mixta)	25 y 41	THE CARTOON NETWORK, INC.	11/07/2021	216
525956	17/10/2022	FUJITSU (mixta)	9 (S/D)	FUJITSU LTD.	06/08/2021	216
525958	17/10/2022	ICOM (mixta)	9 (S/D)	ICOM INCORPORATED	16/08/2021	216
525960	17/10/2022	OKI (mixta)	9	OKI ELECTRIC INDUSTRY CO., LTD.	02/08/2021	216
525962	17/10/2022	LAROBETA	5 (S/D)	BAYER CONSUMER CARE AG	05/09/2021	218
525964	17/10/2022	TARMAC	12 (S/D)	Specialized Bicycle Components, Inc.	13/07/2021	194
525965	17/10/2022	STUMPJUMPER	12 (S/D)	Specialized Bicycle Components, Inc.	13/07/2021	194
525969	17/10/2022	SIRRUS	12 (S/D)	Specialized Bicycle Components, Inc.	13/07/2021	194
525970	17/10/2022	S-WORKS	9 (S/D), 12 (S/D) y 25 (S/D)	Specialized Bicycle Components, Inc.	13/07/2021	194
525971	17/10/2022	S WORKS (mixta)	9 (S/D), 12 (S/D) y 25 (S/D)	Specialized Bicycle Components, Inc.	13/07/2021	194
525973	17/10/2022	S (mixta)	9 (S/D), 12 (S/D), 25 (S/D), 28 (S/D) y 35 (S/D)	Specialized Bicycle Components, Inc.	13/07/2021	194
525974	17/10/2022	ROVAL	12 (S/D)	Specialized Bicycle Components, Inc.	13/07/2021	194

N° Exp	Resolución	Denominación	Clases	Titular	Vigencia	Ag.
525975	17/10/2022	ROUBAIX	12 (S/D)	Specialized Bicycle Components, Inc.	13/07/2021	194
525976	17/10/2022	ALLEZ	12 (S/D)	Specialized Bicycle Components, Inc.	14/07/2021	194
525981	17/10/2022	BRAIN	12 (S/D)	Specialized Bicycle Components, Inc.	14/07/2021	194
525982	17/10/2022	DEMO	12 (S/D)	Specialized Bicycle Components, Inc.	14/07/2021	194
525983	17/10/2022	ERA	12 (S/D)	Specialized Bicycle Components, Inc.	14/07/2021	194
525984	17/10/2022	FSR	12 (S/D)	Specialized Bicycle Components, Inc.	14/07/2021	194
525985	17/10/2022	PAVE	12 (S/D)	Specialized Bicycle Components, Inc.	14/07/2021	194
525986	17/10/2022	ROCKHOPPER	12 (S/D)	Specialized Bicycle Components, Inc.	14/07/2021	194
525987	17/10/2022	BODY GEOMETRY	12 (S/D), 25 (S/D) y 28 (S/D)	Specialized Bicycle Components, Inc.	12/08/2021	194
525989	17/10/2022	TERRACAN (mixta)	12	HYUNDAI MOTOR COMPANY	12/07/2021	216
525991	17/10/2022	BEN 10 ALIEN FORCE (mixta)	3 (S/D), 14, 18, 20, 21, 24, 29, 30 y 32	THE CARTOON NETWORK, INC.	26/07/2021	216
525993	17/10/2022	GLOBE	12 (S/D)	Globe motem LLC	14/07/2021	194
525997	17/10/2022	PROCTOFALK	5	Dr. FALK PHARMA GmbH	30/08/2021	165
525999	17/10/2022	INTESTICORT	5	Dr. FALK PHARMA GmbH	14/08/2021	165
526006	17/10/2022	BARRY BLACK	25	LULITRADE LLC	07/07/2021	118
526008	18/10/2022	ZORRO	3	ALICORP ARGENTINA S.C.A.	06/07/2021	212
526009	17/10/2022	DL (mixta)	30 y 33	D/CE HOLDINGS LLC.	06/07/2021	212
526011	18/10/2022	DELEÓN DL (mixta)	33	D/CE HOLDINGS LLC.	06/07/2021	212
526022	18/10/2022	GEOGARDEN (mixta)	1, 5 y 31	DAPAMA URUGUAY S.A.	07/07/2021	245
526023	18/10/2022	SHALIMAR (mixta)	3 (S/D)	GUERLAIN	18/09/2021	245
526024	18/10/2022	MITSOUKO (mixta)	3 (S/D)	GUERLAIN	19/12/2021	245
526025	18/10/2022	HOTEL CASINO SAN RAFAEL	41 (S/D) y 43 (S/D)	FOSARA SOCIEDAD ANÓNIMA	12/10/2021	212
526030	18/10/2022	FLESH	25 y 28	GÓMEZ LARRIERA, FRANCISCO	25/07/2021	189
526031	18/10/2022	E. GOYARD (mixta)	18 (S/D)	GOYARD ST- HONORE SOCIÉTÉ ANONYME	08/09/2021	212
526034	17/11/2022	BOTTO GIUSEPPE (mixta)	24 (S/D)	BOTTO GIUSEPPE & FIGLI S.P.A.	02/08/2021	212
526035	28/10/2022	PANVAX	5 (S/D)	Seqirus UK Limited	04/01/2022	194
526037	18/10/2022	SONHARE	5 (S/D) y 29 (S/D)	GINSANA S.A.	10/08/2021	34

N° Exp	Resolución	Denominación	Clases	Titular	Vigencia	Ag.
526043	18/10/2022	DOMECQ	32 (S/D) y 33 (S/D)	DOMECQ BODEGA LAS COPAS, S.L.	21/08/2021	144
526045	18/10/2022	CORMORAN	5 (S/D)	ADAMA Makhteshim Ltd.	22/07/2021	165
526046	18/10/2022	BIC (mixta)	8 (S/D)	SOCIETE BIC	05/09/2021	212
526048	18/10/2022	BX7	34 (S/D)	SOCIETE BIC	05/09/2021	212
526051	18/10/2022	BAJITNKA (mixta)	32	BALTIKA BREWERIES	15/07/2021	34
526052	18/10/2022	ENCIENDA Y LLAME!	9 (S/D)	SOCIETE BIC	13/09/2021	212
526054	18/10/2022	SOLEIL (mixta)	8 (S/D)	SOCIETE BIC	19/09/2021	212
526058	18/10/2022	COVERSYL	5	BIOFARMA	09/09/2021	212
526060	28/10/2022	AZUFERTIL (mixta)	1	Nutrien Ag Solutions Argentina S.A.	08/07/2021	94
526061	28/10/2022	ASP URUGUAY (mixta)	31, 35 y 44	Nutrien Ag Solutions Argentina S.A.	28/11/2021	94
526062	28/10/2022	ASP URUGUAY (mixta)	1 (S/D) y 5 (S/D)	Nutrien Ag Solutions Argentina S.A.	28/11/2021	94
526065	28/10/2022	ASP URUGUAY HACE LA DIFERENCIA (mixta)	31, 35 y 44	Nutrien Ag Solutions Argentina S.A.	28/11/2021	94
526068	28/10/2022	ASP URUGUAY HACE LA DIFERENCIA (mixta)	1 (S/D) y 5 (S/D)	Nutrien Ag Solutions Argentina S.A.	28/11/2021	94
526069	18/10/2022	SLALOM	10 (S/D)	Cardinal Health 529, LLC	23/08/2021	194
526070	19/10/2022	DALYCOR	5	FARMACO URUGUAYO S.A.	05/09/2021	181
526073	18/10/2022	GLOBE AUSTRALIA (mixta)	25	GLOBE INTERNATIONAL NOMINEES PTY. LTD.	30/08/2021	245
526074	18/10/2022	DETER JANE (mixta)	3	The Clorox International Company	11/07/2021	228
526077	18/10/2022	GALISAN ROSENBUSCH	5 (S/D)	LABORATORIOS ROSENBUSCH S.A.	24/07/2021	219
526078	18/10/2022	ENERBOV	31	VETERINARIA BORTAGARAY Y CIA. LTDA.	29/07/2021	219
526079	18/10/2022	MC2	32	JULIO CESAR ESTABLE MEXIGOS	26/07/2021	
526081	18/10/2022	LOS 4 ASES (mixta)	35	LOS 4 ASES S.A.	12/07/2021	220
526082	18/10/2022	PERSONA	5 y 10	SPD Swiss Precision Diagnostics GmbH	19/11/2021	136
526084	18/10/2022	PUEBLO BARRANCAS	43	Jorge Tiscornia Ventura	12/07/2021	144
526087	18/10/2022	MCT	12 (S/D)	DECELESTE S.A.	13/07/2021	189
526088	18/10/2022	PALERMO ULTRA LIGHT (mixta)	34	TABACALERA DEL ESTE S.A.	17/10/2021	144
526089	18/10/2022	YUANXING	12	DECELESTE S.A.	13/07/2021	189

N° Exp	Resolución	Denominación	Clases	Titular	Vigencia	Ag.
526099	19/10/2022	GUALY	19 y 20	Gualy S.A.	08/07/2021	101
526101	19/10/2022	BARCELÓ BUSINESS TRAVEL (mixta)	38 (S/D) y 39 (S/D)	BARCELÓ CORPORACIÓN EMPRESARIAL, S.A.	23/08/2021	216
526104	19/10/2022	GBS (mixta)	33 (S/D) y 41 (S/D)	ALLIED DOMEQ SPIRITS AND WINE LIMITED	06/10/2021	205
526105	19/10/2022	ALTEZZA	14, 18 y 25	TAMIBEL GROUP S.A.	05/08/2021	181
526110	15/11/2022	HAIR ONE	20 y 21	Silvia Alicia Muñiz Cucurullo	11/07/2021	
526125	19/10/2022	EDIMBURGO	32 (S/D) y 33 (S/D)	FNC SOCIEDAD ANONIMA	03/08/2021	144
526126	19/10/2022	NEWPORT	3	GALYFER S.A.	02/08/2021	144
526128	19/10/2022	TUBACERO	6, 7 y 11	TUBACERO S.A.	20/11/2021	144
526129	19/10/2022	LA ABUNDANCIA	3, 16, 29, 30, 31, 32, 33 y 41	SILCOM S.A.	17/08/2021	144
526130	15/11/2022	VITALIDE	5	PHARMOS S.A.	09/08/2021	144
526131	15/11/2022	MONTECABLE VOS TENÉS EL CONTROL. DIGITAL (mixta)	38 y 41	MONTE CABLEVIDEO S.A.	08/08/2021	144
526132	19/10/2022	COLEGIO RICHARD ANDERSON (mixta)	41	COLEGIO RICHARD ANDERSON S.A.	25/10/2021	144
526133	19/10/2022	ANANÁ	25	DIEGO LONGO	28/11/2021	144
526135	19/10/2022	(figurativa)	25 (S/D)	KICKERS INTERNATIONAL BV	22/08/2021	194
526136	19/10/2022	CLEAN WAY	5	FADOWEL S.A.	02/08/2021	194
526139	28/10/2022	INTIMA HOGAR (mixta)	24	Grupo Zet Internacional, S.A. de CV	12/07/2021	104
526143	19/10/2022	LIBERATE	1 (S/D)	Loveland Products, Inc.	26/10/2021	220
526145	19/10/2022	MARLUVAS	9	Marluvas Calçados de Segurança Ltda.	11/07/2021	101
526146	19/10/2022	FLÖSSER	9 (S/D) y 11 (S/D)	FLÖSSER GmbH & Co. KG,	12/07/2021	101
526151	19/10/2022	ESCRITORIO PAGES MAÑAY	35 y 36	CARLOS RUFINO PAGES PINEDA	13/07/2021	219
526154	19/10/2022	H2OH! (mixta)	32	PORTFOLIO CONCENTRATE SOLUTIONS UNLIMITED COMPANY	14/07/2021	201
526155	19/10/2022	PACKINEXPRES	16	FERRARI, MYRIAM	13/07/2021	201
526157	19/10/2022	ALLISON TRANSMISSION (mixta)	7 (S/D), 12 (S/D) y 37 (S/D)	ALLISON TRANSMISSION, INC.	16/07/2021	201

N° Exp	Resolución	Denominación	Clases	Titular	Vigencia	Ag.
526158	19/10/2022	MULTI CEREAL RICARD	30 (S/D)	Panificadora Bimbo del Uruguay S.A.	26/10/2021	181
526159	19/10/2022	CUBAN CRACKER	30	Panificadora Bimbo del Uruguay S.A.	30/11/2021	181
526162	19/10/2022	JARLSBERG (mixta)	29 (S/D)	TINE S.A.	13/07/2021	194
526164	19/10/2022	SANIDETER	3 (S/D) y 5 (S/D)	ELECTROQUIMICA S.A.	09/08/2021	194
526165	19/10/2022	SUBMARINER	14	ROLEX SA	04/10/2021	144
526166	19/10/2022	COSMOGRAPH	14	ROLEX SA	30/08/2021	144
526167	19/10/2022	YACHT-MASTER	14	ROLEX SA	04/10/2021	144
526169	19/10/2022	DELI & CIA.	29, 30 y 31	COMPAÑIA OLEAGINOSA URUGUAYA S.A	09/08/2021	144
526170	19/10/2022	SIBARITA	29 (S/D)	COMPAÑIA OLEAGINOSA URUGUAYA S.A.	30/08/2021	144
526171	19/10/2022	ATIBAX FABOP	5	SAVANT PHARM S.A.	24/08/2021	144
526172	19/10/2022	VIVERO - MONTES (mixta)	31 y 35	JAVIER MONTES FARIÑA	05/09/2021	144
526173	19/10/2022	HARI	29	MOLINOS SAN JOSE S.A.	23/09/2021	144
526175	19/10/2022	CONNECTATE	42	NIFELCO S.A.	26/11/2021	165
526177	19/10/2022	BAKUGAN	9, 28 y 41	SPIN MASTER LTD.	12/07/2021	212
526178	19/10/2022	BAKUGAN BATTLE BRAWLERS (mixta)	9, 28 y 41	SPIN MASTER LTD.	12/07/2021	212
526193	28/10/2022	CONFITERIA ESMERALDA	43	LÓPEZ Y PARDIÑAS LTDA.	16/10/2021	189
526194	19/10/2022	RICCI RICCI	3 (S/D)	PUIG FRANCE, Société par Actions Simplifiée.	02/08/2021	245
526195	19/10/2022	L'AIR DU TEMPS	3 (S/D), 8 (S/D), 22 (S/D) y 26 (S/D)	PUIG FRANCE, Société par Actions Simplifiée.	26/11/2021	245
526197	28/10/2022	DAIVONEX	5 (S/D)	LEO Pharma A/S	16/08/2021	194
526200	19/10/2022	FIFA WORLD CUP	33	Fédération Internationale de Football Association (FIFA)	18/08/2021	194
526202	19/10/2022	SIGNORICCI	3 (S/D), 8 (S/D), 22 (S/D) y 26 (S/D)	PUIG FRANCE, Société par Actions Simplifiée.	26/11/2021	245
526203	19/10/2022	PACO RABANNE	3 (S/D)	PUIG FRANCE, Société par Actions Simplifiée.	21/08/2021	245

N° Exp	Resolución	Denominación	Clases	Titular	Vigencia	Ag.
526205	20/10/2022	PITNEY BOWES	7 y 9	PITNEY BOWES INC.	16/07/2021	201
526207	20/10/2022	CEBO Y VOY CANARIAS (mixta)	30 y 35	CANARIAS S.A.	06/12/2021	94
526208	20/10/2022	LA RUEDA DEL MATE MAS GRANDE DEL MUNDO	30 y 35	CANARIAS S.A.	27/12/2021	94
526211	20/10/2022	RED SURCOS (mixta)	1, 5 y 44	Mundo Surcos S.A.	20/01/2021	220
526212	20/10/2022	MICROACTIVE	1 y 5	Mundo Surcos S.A.	27/07/2021	220
526213	20/10/2022	NERO	5	Mundo Surcos S.A.	25/07/2021	220
526217	20/10/2022	EUTHYROX	5 (S/D)	MERCK KGaA	14/07/2021	129
526219	20/10/2022	RAPACAN	5	LABORATORIO LIBRA SOCIEDAD ANONIMA	14/07/2021	129
526220	20/10/2022	ORLITROY	5	LABORATORIO LIBRA SOCIEDAD ANONIMA	14/07/2021	129
526221	20/10/2022	ETOCHEM	3, 5 y 38	KÖNIG URUGUAY SOCIEDAD ANONIMA	14/07/2021	129
526223	20/10/2022	GAGGENAU	7 (S/D), 9 (S/D), 10 (S/D), 11 (S/D), 16 (S/D), 20 (S/D), 21 (S/D), 35 (S/D), 37 (S/D) y 41 (S/D)	BSH Hausgeräte GmbH	19/10/2021	136
526224	20/10/2022	PALMESANO (mixta)	30	OSVALDO ANTONIO PALMESANO	20/06/2021	144
526229	20/10/2022	AMALFI	3 (S/D)	QUIMI ROMAR, S.L.	01/10/2021	94
526230	20/10/2022	SISTEMIS SURCOS	5 (S/D)	Mundo Surcos S.A.	02/08/2021	220
526232	20/10/2022	WRIGHTSON PAS (mixta)	31 y 44	PGG Wrightson Uruguay Limited S.A.	13/01/2021	194
526234	20/10/2022	SECTEUR	12 (S/D)	Specialized Bicycle Components, Inc.	13/07/2021	194
526235	20/10/2022	BIG HIT	12 (S/D)	Specialized Bicycle Components, Inc.	14/07/2021	194
526236	20/10/2022	DUTY POINT	35	NAVINTEN S.A.	20/07/2021	201
526237	20/10/2022	PITCH	12 (S/D)	Specialized Bicycle Components, Inc.	14/07/2021	194
526238	20/10/2022	HOTROCK	12 (S/D)	Specialized Bicycle Components, Inc.	14/07/2021	194
526239	20/10/2022	CROSSTRAIL	12 (S/D)	Specialized Bicycle Components, Inc.	14/07/2021	194
526240	20/10/2022	TRICROSS	12 (S/D)	Specialized Bicycle Components, Inc.	14/07/2021	194

N° Exp	Resolución	Denominación	Clases	Titular	Vigencia	Ag.
526242	20/10/2022	AEG	9 (S/D)	AB ELECTROLUX	02/08/2021	201
526243	20/10/2022	FABER-CASTELL	16 (S/D)	FABER-CASTELL AG.	05/11/2021	194
526244	20/10/2022	RENAULT DYNAMIQUE	12	RENAULT S.A.S.	03/08/2021	201
526248	20/10/2022	COMMAND POST	12 (S/D)	Specialized Bicycle Components, Inc.	14/07/2021	194
526250	20/10/2022	ARMADILLO	12 (S/D)	Specialized Bicycle Components, Inc.	14/07/2021	194
526251	20/10/2022	HARDROCK	12 (S/D)	Specialized Bicycle Components, Inc.	14/07/2021	194
526252	20/10/2022	FUSE	12 (S/D)	Specialized Bicycle Components, Inc.	14/07/2021	194
526253	20/10/2022	FORESTAL ORIENTAL (mixta)	1, 19, 31, 40, 42 y 44	FORESTAL ORIENTAL S.A.	22/08/2021	205
526255	20/10/2022	CARNAVAL	21 (S/D)	SOLO CUP OPERATING CORPORATION	04/09/2021	194
526256	20/10/2022	ABSOLUT COUNTRY OF SWEDEN KURANT (mixta)	33	THE ABSOLUT COMPANY AKTIEBOLAG	22/10/2021	205
526258	20/10/2022	ABSOLUT COUNTRY OF SWEDEN MANDRIN (mixta)	33 (S/D)	THE ABSOLUT COMPANY AKTIEBOLAG	22/10/2021	205
526260	20/10/2022	ULTRALIMP. PROTEGE EL MEDIO AMBIENTE. PRODUCTO NATURAL (mixta)	1, 3 y 5	Gustavo Daniel Liesegang Fernandez	14/07/2021	
526280	20/10/2022	ESPRIT (mixta)	9 (S/D), 14 (S/D), 16 (S/D), 18 (S/D), 20 (S/D), 24 (S/D) y 35 (S/D)	ESPRIT INTERNATIONAL	12/08/2021	144
526287	20/10/2022	M (mixta)	30	Mars, Incorporated	20/11/2021	245
526288	20/10/2022	UNCLE BEN'S	25, 29 y 30	Mars, Incorporated	30/12/2021	245
526290	20/10/2022	HERRERA FOR MEN (mixta)	3	Carolina Herrera Ltd.	20/11/2021	245
526292	20/10/2022	EVOQUIN (mixta)	5 (S/D)	TEVA URUGUAY S.A.	03/09/2021	245
526293	20/10/2022	TAXAGON	5 (S/D)	TEVA URUGUAY S.A.	26/10/2021	245
526294	20/10/2022	LIPIBEC	5	IVAX ARGENTINA S.A.	22/10/2021	227
526296	20/10/2022	MCDUO	30	McDonald's Corporation	18/08/2021	186
526301	20/10/2022	MCDONALD'S (mixta)	43 (S/D)	McDonald's Corporation	23/10/2021	186
526302	20/10/2022	HISEN (mixta)	9 y 11	HISENSE CO., LTD.	30/11/2021	201

N° Exp	Resolución	Denominación	Clases	Titular	Vigencia	Ag.
526303	20/10/2022	RONALD MCDONALD (mixta)	43 (S/D)	McDonald's Corporation	23/10/2021	186
526304	21/10/2022	M (mixta)	43 (S/D)	McDonald's Corporation	23/10/2021	186
526306	21/10/2022	HISENSE (mixta)	9 y 11	HISENSE CO., LTD.	25/09/2021	201
526307	21/10/2022	MCDULZURAS (mixta)	29	McDonald's Corporation	09/11/2021	186
526308	21/10/2022	PRINT-RITE (mixta)	2 (S/D)	HANA COMPANY LIMITED	10/08/2021	201
526312	21/10/2022	MCCHEDDAR (mixta)	30	McDonald's Corporation	31/10/2021	186
526323	21/10/2022	F FUJIKURA (mixta)	9 (S/D)	FUJIKURA LTD.	04/07/2021	216
526324	21/10/2022	VAGARY (mixta)	14 (S/D)	CITIZEN TOKEI KABUSHIKI KAISHA ALSO TRADING AS CITIZEN WATCH CO., LTD	22/07/2021	216
526325	21/10/2022	YKK (mixta)	18 (S/D), 24 (S/D) y 26 (S/D)	YKK CORPORATION	20/07/2021	216
526326	21/10/2022	E FRIENDLY (mixta)	9 (S/D), 35 (S/D) y 37 (S/D)	FURUKAWA ELECTRIC CO., LTD.	05/09/2021	94
526327	21/10/2022	SHARP (mixta)	16, 38, 42 (S/D) y 43 (S/D)	SHARP KABUSHIKI KAISHA (TAMBIEN COMERCIANDO COMO SHARP CORPORATION)	19/09/2021	216
526328	21/10/2022	TIME WARNER	9, 16, 35, 38 y 41	Warner Media, LLC	18/04/2021	216
526330	21/10/2022	R LA ESTANCIA 1937 (mixta)	33	RODRIGUEZ HNOS. Y CIA. LTDA.	19/08/2021	220
526331	15/11/2022	(figurativa)	6 (S/D)	EJ EMEA	30/08/2021	181
526335	21/10/2022	PRO PERFORMANCE	5	GNC HOLDINGS, LLC	15/02/2021	94
526338	21/10/2022	REFENAX	5	LABORATORIOS MONSERRAT Y ECLAIR SOCIEDAD ANONIMA	21/11/2021	144
526339	21/10/2022	PULMOCLER	5	LABORATORIOS MONSERRAT Y ECLAIR SOCIEDAD ANONIMA	21/11/2021	144
526340	21/10/2022	PALATROBIL	5	LABORATORIOS MONSERRAT Y ECLAIR SOCIEDAD ANONIMA	21/11/2021	144
526341	21/10/2022	KRITEL	5	LABORATORIOS MONSERRAT Y ECLAIR SOCIEDAD ANONIMA	24/11/2021	144
526342	21/10/2022	KIPERGRIP	5	LABORATORIOS MONSERRAT Y ECLAIR SOCIEDAD ANONIMA	21/11/2021	144

N° Exp	Resolución	Denominación	Clases	Titular	Vigencia	Ag.
526343	21/10/2022	BUCOTRICIN	5	LABORATORIOS MONSERRAT Y ECLAIR SOCIEDAD ANONIMA	24/11/2021	144
526344	21/10/2022	THE GORDON HIGHLANDERS	33 (S/D)	WILLIAM GRANT & SONS LIMITED	22/10/2021	144
526345	21/10/2022	HERCULES (mixta)	8 (S/D) y 21 (S/D)	HERCULES S.A FABRICA DE TALHERES	20/07/2021	194
526354	21/10/2022	ORANGE (mixta)	16 (S/D), 18 (S/D), 25 (S/D), 28 (S/D), 35 (S/D), 36 (S/D), 37 (S/D), 39 (S/D), 41 (S/D), 42 (S/D), 43 (S/D), 44 (S/D) y 45 (S/D)	ORANGE BRAND SERVICES LIMITED	26/10/2021	212
526362	21/10/2022	VITAMINLIFE WELLNESS SCIENCE R (mixta)	5 (S/D), 30 y 31	FARMACEUTICA MEDCELL LIMITADA	01/08/2021	221
526363	21/10/2022	RETRO	29 y 30	PEPSICO, INC.	21/07/2021	201
526364	21/10/2022	NAKED	29 (S/D) y 30 (S/D)	PEPSICO, INC.	21/07/2021	201
526365	21/10/2022	VILASAR	33	VINOS FINOS JUAN CARRAU S.A.	03/08/2021	201
526382	21/10/2022	VALENT (mixta)	29	PRODUCTOS VALENT, S.A.	18/10/2021	181
526384	21/10/2022	PENNZOIL (mixta)	4 (S/D)	PENNZOIL-QUAKER STATE COMPANY	03/12/2021	144
526386	21/10/2022	TSUBO	25	RICH DEVELOPMENT LIMITED	14/11/2021	34
526387	21/10/2022	DELINUT	30	CIA INDUSTRIAL DE ALIMENTAÇÃO TRADING COMPANY	12/01/2022	34
526388	21/10/2022	QUANTUM	1	LAGE & CIA . S.A.	04/08/2021	201
526389	21/10/2022	LAFEM DISPERT	5	LABORATORIOS DISPERT S.A.	09/08/2021	201
526390	21/10/2022	MABEL	32 (S/D)	CIPA INDUSTRIAL DE PRODUTOS ALIMENTARES LTDA.	09/08/2021	201
526393	21/10/2022	TIP (mixta)	9, 35, 36, 37 y 39	TIP DE MEXICO S.A.P.I. DE C.V.	22/10/2021	181
526396	21/10/2022	TIP	9, 35, 36, 37 y 39	TIP DE MEXICO, S.A.P.I. DE C.V.	22/10/2021	181
526397	21/10/2022	SOMAR	7 y 8	Schulz S.A.	12/09/2021	101
526398	21/10/2022	LAGUNA DE ROCHA LT 32°	35 y 36	MARTIN BALACIANO y ANDRES	02/05/2021	118

N° Exp	Resolución	Denominación	Clases	Titular	Vigencia	Ag.
		40°LATITUD SUR - 54° 16'LONGITUD OESTE RESERVA DE BIOSFERA (mixta)		BALACIANO		
526400	21/10/2022	FOX	38 y 41	FOX MEDIA LLC.	28/11/2021	245
526402	21/10/2022	LABORATORIO VEINFAR URUGUAY S.A. ESPECIALIDADES FARMACÉUTICAS LARJAN	5 (S/D)	LABORATORIO VEINFAR URUGUAY S.A.	26/07/2021	189
526404	21/10/2022	YUMBO 4 TRACK	12	DECELESTE S.A.	30/09/2021	189
526408	24/10/2022	BRENNTAG	1 (S/D), 2 (S/D), 3 (S/D), 4 (S/D), 37 (S/D), 39 (S/D), 40 (S/D) y 42 (S/D)	Brenntag Holding GmbH	28/07/2021	219
526409	24/10/2022	HIGHER	3 (S/D)	Parfums Christian Dior, S.A.	14/08/2021	227
526410	24/10/2022	MIPROL URUFARMA	5	URUFARMA S.A.	19/07/2021	34
526412	24/10/2022	SEALSURE	10 (S/D)	ASP Global Manufacturing GmbH	24/01/2021	194
526413	24/10/2022	MILLER	9 (S/D)	Honeywell Safety Products USA, Inc	19/07/2021	34
526414	16/11/2022	SOLGAR (mixta)	5	SOLGAR HOLDINGS,INC.	05/09/2021	216
526417	24/10/2022	SENSORMATIC	9	TYCO FIRE & SECURITY GMBH	25/10/2021	144
526425	24/10/2022	OH! ONE HARBOUR SHOPS (mixta)	35 y 36	STOLOVITSKY COLB, JAVIER	24/08/2021	201
526426	24/10/2022	CEYS	1, 16 y 17	COMERCIAL DE EXCLUSIVAS Y SUMINISTROS S.A.	05/09/2021	220
526427	24/10/2022	MOTO MADE FOR WINNERS (mixta)	4 (S/D)	TotalEnergies SE	08/08/2021	201
526428	24/10/2022	187 CHANDON	33 (S/D)	MHCS	16/08/2021	201
526429	24/10/2022	MOËT IMPERIAL	33 (S/D)	MHCS	17/08/2021	201
526430	24/10/2022	SONY MUSIC (mixta)	9 (S/D), 16 (S/D), 35 (S/D) y 41 (S/D)	SONY CORPORATION	12/08/2021	201
526431	24/10/2022	ORTOPÉ (mixta)	25	PAQUETÁ CALÇADOS LTDA.	24/08/2021	201
526432	24/10/2022	MERCILON	5 (S/D)	N. V. ORGANON	22/10/2021	201
526434	24/10/2022	INVANZ (mixta)	5	Merck Sharp & Dohme Corp.	26/10/2021	192
526435	24/10/2022	UHRENHOLT	29 (S/D), 30 (S/D), 31 (S/D) y 35 (S/D)	F. UHRENHOLT HOLDING A/S	16/08/2021	192

N° Exp	Resolución	Denominación	Clases	Titular	Vigencia	Ag.
526437	24/10/2022	ALLFUNDS BANK (mixta)	38	ALLFUNDS BANK S.A.	26/07/2021	194
526438	24/10/2022	ALLFUNDS BANK (mixta)	36	ALLFUNDS BANK S.A.	26/07/2021	194
526439	24/10/2022	ALLFUNDS BANK (mixta)	16	ALLFUNDS BANK S.A.	26/07/2021	194
526443	24/10/2022	TNT	39 (S/D)	TNT HOLDINGS B.V.	19/08/2021	194
526447	24/10/2022	CARTOONS	18, 25 y 28	ENCATEX S.A.	29/11/2021	94
526449	24/10/2022	MELACIDE	16	TECNICAS QUIMICAS INDUSTRIALES, S.A. (TEQUISA)	14/08/2021	144
526454	24/10/2022	ZUUM (mixta)	3 (S/D) y 5 (S/D)	US COTTON MÉXICO, S. DE R.L. DE C.V.	22/07/2021	34
526457	24/10/2022	LACTEOL FORT	5	ADARE PHARMACEUTICALS S.A.S.	16/08/2021	201
526461	24/10/2022	INGLES PARA TODA LA VIDA	41	INSTITUTO CULTURAL ANGLO-URUGUAYO	26/07/2021	201
526462	24/10/2022	THE ANGLO SCHOOL (mixta)	16, 25 y 41 (S/D)	INSTITUTO CULTURAL ANGLO URUGUAYO	23/08/2021	201
526463	24/10/2022	TRIBAL (mixta)	25	Claudia Isabel AGRASO MUIÑO - Oscar BARRAGAN	20/07/2021	163
526464	24/10/2022	INGLES SEGURO	41	INSTITUTO CULTURAL ANGLO-URUGUAYO	12/09/2021	201
526465	24/10/2022	MONTELLO	29 y 33	POLAKOF Y CIA. S.A.	06/12/2021	94
526472	24/10/2022	MUDD	25 (S/D)	Iconix Latin America LLC	20/07/2021	194
526473	24/10/2022	ESCAPE	12 (S/D)	FORD MOTOR COMPANY	25/10/2021	194
526478	24/10/2022	H (mixta)	12	HELVETICA S.A.	22/07/2021	245
526479	24/10/2022	HELVÉTICA (mixta)	12	HELVETICA S.A.	22/07/2021	245
526488	24/10/2022	RI-K	30 (S/D)	Unilever IP Holdings B.V.	04/10/2021	136
526489	24/10/2022	NINTENDODSI (mixta)	28 (S/D)	Nintendo of America Inc.	26/08/2021	136
526493	24/10/2022	SIMPLEXX	5 (S/D)	Novo Nordisk Health Care AG	14/11/2021	181
526494	24/10/2022	BACTIO-RHIN	5	TAKEDA GmbH	21/08/2021	34
526500	24/10/2022	LYSOFORM	21 (S/D)	S.C. JOHNSON & SON, INC.	04/01/2022	34
526502	24/10/2022	GRAFFITI	30 (S/D)	BAGLEY ARGENTINA S.A.	22/07/2021	154
526503	24/10/2022	ROCEPHIN	5	ROCHE INTERNATIONAL LTD	21/08/2021	201

N° Exp	Resolución	Denominación	Clases	Titular	Vigencia	Ag.
526505	24/10/2022	COAGUCHEK (mixta)	5 (S/D) y 10 (S/D)	ROCHE DIAGNOSTICS GMBH	19/09/2021	201
526507	24/10/2022	DALVIEV	5	F.HOFFMANN-LA ROCHE AG.	27/09/2021	201
526511	24/10/2022	NEFALGIC	5 (S/D)	BIOCODEX	13/10/2021	216
526515	25/10/2022	BONDUELLE (mixta)	29 (S/D), 30 (S/D) y 31 (S/D)	BONDUELLE SOCIÉTÉ ANONYME	01/08/2021	144
526516	15/11/2022	CAVILON	5 (S/D)	3M Company	18/11/2021	194
526517	25/10/2022	NOTEFIX	10 (S/D)	3M Company	21/11/2021	194
526518	25/10/2022	3M	36	3M Company	29/11/2021	194
526520	25/10/2022	3M	38	3M Company	29/11/2021	194
526521	25/10/2022	3M	39	3M Company	29/11/2021	194
526522	25/10/2022	3M	40	3M Company	29/11/2021	194
526523	25/10/2022	3M	41	3M Company	29/11/2021	194
526524	25/10/2022	3M	42	3M Company	29/11/2021	194
526525	25/10/2022	3M	43	3M Company	29/11/2021	194
526527	25/10/2022	3M	44	3M Company	29/11/2021	194
526531	25/10/2022	3M	45	3M Company	29/11/2021	194
526532	25/10/2022	VERSAFLO	9 (S/D)	3M Company	26/12/2021	194
526539	25/10/2022	HABÍA UNA VEZ	35 y 38	HUV SRL	22/07/2021	194
526547	25/10/2022	HYALUROLL (mixta)	5	RIPOLL NOVOA, JUAN CARLOS	25/07/2021	227
526554	25/10/2022	BRIK-COL	2 (S/D)	AKZO NOBEL COATINGS INTERNATIONAL B.V.	26/09/2021	34
526556	25/10/2022	INCAMAX TURBO	2	AKZO NOBEL COATINGS INTERNATIONAL B.V.	29/09/2021	34
526561	25/10/2022	PRO-ARGIN	3 (S/D), 5 (S/D) y 21	COLGATE-PALMOLIVE COMPANY	19/08/2021	201
526562	25/10/2022	ROHYPNOL	5	CHEPLAPHARM ARZNEIMITTEL GMBH	21/08/2021	201
526564	25/10/2022	SILENZIO	25	JOSE HUESPE E HIJOS S.A.I. Y C.	13/08/2021	144
526566	25/10/2022	PERRELET	14 (S/D)	PERRELET SA	24/11/2021	144
526567	25/10/2022	SOLUTEK	1 (S/D)	COMPAGNIE FINANCIERE ET DE	06/09/2021	144

N° Exp	Resolución	Denominación	Clases	Titular	Vigencia	Ag.
				PARTICIPATIONS ROULLIER		
526568	25/10/2022	AMOURETTE	25 (S/D)	TRIUMPH INTERTRADE AG	21/08/2021	201
526575	25/10/2022	RESTASIS (mixta)	5 (S/D)	ALLERGAN, INC.	30/08/2021	201
526576	25/10/2022	GENACOL	5	Corporation Genacol Canada Inc.	17/11/2021	94
526578	25/10/2022	BURTON (mixta)	24 (S/D) y 25 (S/D)	LEOPOLDO GROSS & ASOCIADOS S.A.	22/03/2021	192
526580	25/10/2022	LINDE (mixta)	4, 6, 9, 39, 42 y 44	Linde GmbH	08/08/2021	192
526581	25/10/2022	MEGASUR	35 y 37	MEGAPIN S.A.	12/08/2021	212
526582	25/10/2022	SINAMIDA	3 y 5	HIPERFARM S.A.	31/10/2021	94
526591	25/10/2022	XALACOM	5 (S/D)	UPJOHN US 1 LLC	30/08/2021	34
526593	25/10/2022	PATREX	5 (S/D)	UPJOHN US 1 LLC	05/09/2021	34
526595	25/10/2022	DANUBIO	3 (S/D)	CASA DANUBIO S.A.	06/08/2021	245
526601	25/10/2022	TAMANGO	3 (S/D)	LEONARD PARFUMS	03/12/2021	181
526602	25/10/2022	EL GORDO Y LA FLACA (mixta)	41 (S/D)	UNIVISION COMMUNICATIONS INC.	23/08/2021	194
526603	25/10/2022	OTTO KUNZ (mixta)	29 (S/D)	SOCIEDAD SUIZO PERUANA DE EMBUTIDOS S.A.	03/09/2021	181
526604	25/10/2022	NUESTRA BELLEZA LATINA (mixta)	41 (S/D)	UNIVISION COMMUNICATIONS INC.	27/09/2021	194
526605	25/10/2022	OSTER (mixta)	9 (S/D), 11 (S/D) y 18 (S/D)	Sunbeam Products, Inc.	29/09/2021	194
526606	25/10/2022	LILLO (mixta)	10 (S/D) y 21 (S/D)	Lillo do Brasil Indústria e Comércio de Produtos Infantis Ltda.	06/09/2021	194
526618	25/10/2022	NATIONAL GEOGRAPHIC (mixta)	18 y 25	NATIONAL GEOGRAPHIC SOCIETY	26/10/2021	34
526619	25/10/2022	SACRO (mixta)	25	Fernando Raul Espino Santorcieri	27/07/2021	101
526631	25/10/2022	PUREIT	3 (S/D), 5 (S/D), 11 (S/D), 21 (S/D), 32 (S/D) y 40 (S/D)	Unilever Global IP Limited	26/10/2021	136
526632	25/10/2022	C-VALE ESE NOMBRE TIENE SABOR (mixta)	29	C.VALE COOPERATIVA AGROINDUSTRIAL	07/09/2021	201
526633	25/10/2022	FRUIT OF THE LOOM (mixta)	6 (S/D), 18 (S/D), 19 (S/D), 20 (S/D), 22 (S/D), 24 (S/D),	FRUIT OF THE LOOM, INC.	21/08/2021	194

N° Exp	Resolución	Denominación	Clases	Titular	Vigencia	Ag.
			26 (S/D), 27 (S/D) y 28 (S/D)			
526635	26/10/2022	FRUIT OF THE LOOM (mixta)	18 (S/D) y 25 (S/D)	FRUIT OF THE LOOM, INC.	21/08/2021	194
526637	26/10/2022	FRUIT OF THE LOOM (mixta)	16 (S/D), 20 (S/D), 21 (S/D), 22 (S/D), 23 (S/D), 24 (S/D), 25 (S/D) y 26 (S/D)	FRUIT OF THE LOOM, INC.	21/08/2021	194
526638	26/10/2022	FRUIT OF THE LOOM (mixta)	2 (S/D), 3 (S/D), 6 (S/D), 7 (S/D), 8 (S/D), 18 (S/D), 21 (S/D), 25 (S/D) y 26 (S/D)	FRUIT OF THE LOOM, INC.	21/08/2021	194
526641	26/10/2022	SOLDO	38, 39 y 41	SOLDO HNOS. S.A.	26/09/2021	245
526642	26/10/2022	SOLDO	42	SOLDO HNOS. S.A.	27/09/2021	245
526643	26/10/2022	COMENTER	5	ZODIAC INTERNATIONAL CORPORATION	05/12/2021	245
526646	26/10/2022	SOLDO	36	SOLDO HNOS. S.A.	26/09/2021	245
526654	26/10/2022	ÖXXABSOLUT WILD AND FURIOUS (mixta)	25	Eslalon S.A.	05/08/2021	65
526661	26/10/2022	ARTESCO	16	ARTESCO S.A.	02/08/2021	194
526664	26/10/2022	ARTESCO (mixta)	16	ARTESCO S.A.	02/08/2021	194
526665	26/10/2022	ECOCLOR	3	INUR S.A	05/09/2021	156
526670	26/10/2022	INCONCERT (mixta)	9	TECNOLINK S.A.	30/11/2021	156
526674	26/10/2022	VANINI	30	JORGE VALSECCHI	02/08/2021	245
526676	26/10/2022	CONSUME ECO-LYZER	3 (S/D)	Spartan Chemical Company, Inc.	12/10/2021	136
526677	26/10/2022	SERVICAMPO SERVICIOS AGROPECUARIOS (mixta)	31 y 44	SERVICAMPO S.R.L.	20/12/2021	94
526684	26/10/2022	J JUVENTUS (mixta)	41 y 43	JUVENTUS	10/08/2021	105
526700	26/10/2022	SAKATA (mixta)	31	SAKATA SEED CORPORATION	23/01/2022	245
526701	26/10/2022	(figurativa)	31	SAKATA SEED CORPORATION	23/01/2022	245
526702	26/10/2022	SONHO DE VALSA	30 (S/D)	MONDELEZ BRASIL LTDA.	23/10/2021	227

N° Exp	Resolución	Denominación	Clases	Titular	Vigencia	Ag.
526709	26/10/2022	(tridimensional)	3 (S/D)	MAUBOUSSIN SAS	23/08/2021	192
526713	26/10/2022	TURIL (mixta)	39	TURIL S.A.	09/01/2022	192
526714	26/10/2022	SKODA (mixta)	12 (S/D)	SKODA AUTO A.S.	06/09/2021	34
526715	26/10/2022	BIMEDA	3 y 5	BIMEDA ANIMAL HEALTH LIMITED	05/09/2021	34
526717	26/10/2022	PLAZA BUSINESS CENTER (mixta)	35	VAWOY S.A.	22/09/2021	189
526719	26/10/2022	ECOFIBRA (mixta)	19	ARTECOLA INDÚSTRIAS QUÍMICAS LTDA.	11/01/2022	94
526723	26/10/2022	BIMBO (mixta)	29 y 30	GRUPO BIMBO S.A.B. DE C.V.	05/08/2021	181
526724	26/10/2022	B BIMBO (mixta)	25 y 28	GRUPO BIMBO S.A.B. DE C.V.	05/08/2021	181
526726	26/10/2022	BIMBO (mixta)	29 y 30	GRUPO BIMBO S.A.B. DE C.V.	05/08/2021	181
526727	26/10/2022	PROGRESSIVE	21	Progressive International Corporation	03/08/2021	218
526728	26/10/2022	CHOCOLATES LA CORONA 63 AÑOS DE EXPERIENCIA (mixta)	30 (S/D)	GRUPO BIMBO S.A.B. DE C.V.	11/08/2021	181
526730	26/10/2022	TIA ROSA SANISSIMO	30 (S/D)	GRUPO BIMBO S.A.B. DE C.V.	29/09/2021	181
526734	26/10/2022	PAYASO DE RICOLINO	30	GRUPO BIMBO S.A.B. DE C.V.	25/10/2021	181
526735	26/10/2022	RICOLINO	5, 29 y 30	GRUPO BIMBO S.A.B. DE C.V.	28/11/2021	181
526740	26/10/2022	NOOKS & CRANNIES	30	GRUPO BIMBO S.A.B. DE C.V.	04/10/2021	181
526743	26/10/2022	DAYMAN	33	MOREIRA BURASTERO, VIRGINIA ERIKA	03/08/2021	201
526745	26/10/2022	TRITTICO	5 (S/D)	AZIENDE CHIMICHE RIUNITE ANGELINI FRANCESCO A.C.R.A.F. S.P.A.	18/09/2021	201
526746	26/10/2022	JWS (mixta)	33 (S/D)	DIAGEO BRANDS B.V.	15/08/2021	212
526747	15/11/2022	HEINZ (mixta)	5, 29, 30, 31 y 32	H.J. Heinz Company Brands LLC	20/11/2021	194
526749	26/10/2022	SMIRNOFF	33 (S/D)	DIAGEO NORTH AMERICA, INC.	17/08/2021	212
526750	26/10/2022	TRUSOPT	5	MUNDIPHARMA AG	20/11/2021	194
526751	11/11/2022	RESTIVA	5 (S/D)	MUNDIPHARMA AG	16/10/2021	194
526753	26/10/2022	FIDELITY MARKETING (mixta)	35	FIDELITY MARKETING GROUP S. DE R.L. DE C.V.	23/08/2021	194
526756	26/10/2022	COMFORT (mixta)	43 (S/D)	Choice Hotels International, Inc.	03/08/2021	136

N° Exp	Resolución	Denominación	Clases	Titular	Vigencia	Ag.
526757	26/10/2022	(figurativa)	33 (S/D)	DIAGEO BRANDS B.V.	07/10/2021	212
526766	27/10/2022	N N NAFNAF (mixta)	25	NEW NAF NAF	23/08/2021	245
526767	27/10/2022	JAZZ	31	ALISUL ALIMENTOS S.A..	19/12/2021	245
526769	27/10/2022	WATTON	9	UBIPLAN S.A.	10/05/2021	34
526771	27/10/2022	HIGH PEAK	9	UBIPLAN S.A.	15/07/2021	34
526772	27/10/2022	KELLY	35	Kelly Properties, LLC.	06/12/2021	245
526773	27/10/2022	OCA METROS	41	OCA S.A.	27/11/2021	245
526774	27/10/2022	POLYDOR	9 (S/D)	DEUTSCHE GRAMMOPHON GESELLSCHAFT MBH	24/12/2021	245
526775	27/10/2022	OCA METROS	35	OCA S.A.	27/11/2021	245
526776	27/10/2022	OCA METROS	38	OCA S.A.	27/11/2021	245
526777	27/10/2022	BERBAU	30	INDUSTRIA DE BALAS FINAS MUNARFREY LTDA.	21/11/2021	34
526778	27/10/2022	KUKA (mixta)	8 (S/D) y 21 (S/D)	KUKA PRODUTOS INFANTIS LTDA.	30/01/2022	34
526780	27/10/2022	YBS (mixta)	26 (S/D)	NEW WORLD YBS CO., LTD.	16/08/2021	181
526794	04/11/2022	DON PROSPERO	33	LIBROSOL S.A	06/10/2021	
526797	27/10/2022	(figurativa)	25 (S/D)	Tos S.R.L.	25/10/2021	212
526807	28/10/2022	DON DIEGO	33	CIRLON S.A.	03/08/2021	219
526808	28/10/2022	ZARRANZ	32 y 33	CIRLON S.A.	03/08/2021	219
526810	09/11/2022	CIPRIANI (mixta)	43 y 44	ALTUNIS - TRADING, GESTAO E SERVICOS SOCIEDADE UNIPessoal, LDA.	15/11/2021	212
526811	27/10/2022	CIPRIANI (mixta)	32	ALTUNIS - TRADING, GESTAO E SERVICOS SOCIEDADE UNIPessoal, LDA.	30/11/2021	212
526814	20/10/2022	SUPERMERCADOS NORTE-SUR (mixta)	16 y 36	CLARIDEL S.A.	09/08/2021	192
526819	20/10/2022	AMICAN (mixta)	31	MARCOS ROHRER	01/08/2021	118
526821	20/10/2022	MUJERCITAS SUNNY (mixta)	3	Cannon S.A.	05/08/2021	104
526822	20/10/2022	MUJERCITAS FUNNY (mixta)	3	Cannon S.A.	05/08/2021	104

N° Exp	Resolución	Denominación	Clases	Titular	Vigencia	Ag.
526827	20/10/2022	MOTEL ONE 1 (mixta)	35 (S/D)	MOTEL ONE MANAGEMENT GMBH	10/08/2021	144
526828	20/10/2022	AQUABASE	2 (S/D)	PPG INDUSTRIES OHIO, INC.	14/09/2021	144
526829	20/10/2022	OLIMPIC	2	PPG ARCHITECTURAL FINISHES, INC.	17/09/2021	144
526831	20/10/2022	FASTURTEC	5 (S/D)	SANOFI	19/11/2021	144
526832	20/10/2022	CARDI AAS	5	SANOFI	21/10/2021	144
526835	20/10/2022	IMOVAX	5 (S/D)	SANOFI PASTEUR	19/12/2021	165
526836	20/10/2022	A (mixta)	16	ARTESCO S.A.	02/08/2021	194
526838	20/10/2022	JONEXA	5	GENZYME CORPORATION	17/10/2021	165
526839	20/10/2022	LASIX	5 (S/D)	SANOFI-AVENTIS DEUTSCHLAND GMBH	30/11/2021	165
526841	20/10/2022	ACCENTURE (mixta)	9, 16, 35, 36, 37, 41, 42 (S/D), 43 (S/D), 44 (S/D) y 45 (S/D)	ACCENTURE GLOBAL SERVICES LIMITED	31/10/2021	194
526842	20/10/2022	RONAY (mixta)	16, 35, 36, 39, 42, 43, 44 y 45	Ronay S.A.	02/02/2021	101
526843	20/10/2022	MOMO	12 (S/D)	MOMO S.R.L.	23/10/2021	144
526845	20/10/2022	TOPCOLOR	2	RENNER SAYERLACK S.A.	21/08/2021	34
526847	20/10/2022	FORUM TUFU DUEK	3	FORUM CONFECÇÕES LTDA	21/11/2021	34
526852	20/10/2022	SUPERFLO	4	PIRIZ SIMONE, VIRGINIA	20/09/2021	144
526853	20/10/2022	MOVICOL	5 (S/D)	PHARMOS S.A.	04/09/2021	144
526854	20/10/2022	REJUVEX	5 (S/D)	DINEL S.A.	05/09/2021	144
526861	20/10/2022	DE LEY	33	BARRACA DEAMBROSI S.A.	03/08/2021	154
526871	20/10/2022	DUFOUR	3	SOCIETE DUFOUR S.A.	22/10/2021	194
526873	21/10/2022	PATRICHES	3 (S/D)	Unilever Global IP Limited	28/10/2021	136
526874	21/10/2022	WONDERBRA	25 (S/D)	Canadelle Limited Partnership	25/10/2021	136
526875	21/10/2022	RICHIETTI	30 (S/D)	HORMADIL S.A.	09/08/2021	129
526876	21/10/2022	EVILIN	5	MERCK KGaA	09/08/2021	129
526877	21/10/2022	PRELUDE	7 (S/D), 12 (S/D) y 22 (S/D)	HONDA GIKEN KOGYO KABUSHIKI KAISHA (HONDA MOTOR CO., LTD.)	23/10/2021	94

N° Exp	Resolución	Denominación	Clases	Titular	Vigencia	Ag.
526878	21/10/2022	QUERUBIN	3	SOCIETE DUFOUR S.A.	31/10/2021	194
526880	21/10/2022	(figurativa)	5	SERVIMEDIC S.A.	05/09/2021	144
526881	21/10/2022	KOSIUKO (mixta)	14	ANTRIM S.A.	17/01/2022	144
526882	21/10/2022	(figurativa)	29 y 30 (S/D)	LA ELOISA S.A.	01/03/2021	144
526883	21/10/2022	RAPIDMATCH	9 (S/D)	PPG INDUSTRIES OHIO, INC.	26/09/2021	144
526884	21/10/2022	DIANETICA	16 (S/D) y 41 (S/D)	RELIGIOUS TECHNOLOGY CENTER	29/01/2022	144
526895	21/10/2022	CONFIDENTIA WEALTH MANAGEMENT (mixta)	36	FIGUEROA, SANTIAGO AUGUSTO	03/08/2021	194
526896	21/10/2022	HAMMERITE (mixta)	2 (S/D)	AKZO NOBEL COATINGS INTERNATIONAL B.V.	09/10/2021	34
526898	21/10/2022	TERRAMAR (mixta)	35 y 41	TERRAMAR PROPIEDADES S.A.	19/12/2021	181
526899	21/10/2022	GOYA	29, 30, 31, 32 y 33	Goya Foods, Inc.	06/08/2021	34
526901	21/10/2022	LUMIN	19 (S/D), 27 (S/D) y 39 (S/D)	URUPLY S.A.	26/09/2021	221
526908	21/10/2022	DIOXAFLEX MIGRA	5	Gramón Bagó de Uruguay S.A.	12/08/2021	181
526909	21/10/2022	MIGRA DIOXAFLEX	5	Gramón Bagó de Uruguay S.A.	12/08/2021	181
526915	21/10/2022	MEDELA	10 (S/D)	MEDELA HOLDING AG	01/09/2021	201
526916	21/10/2022	DISCONTINUADOS DIVINO	20 y 35	DIVINO S.A.	26/09/2021	201
526917	21/10/2022	DEPIMIEL	3	VILLANUEVA, RUBEN DANIEL	31/10/2021	201
526918	21/10/2022	PETER PAN	25 (S/D)	IVORY INDUSTRIAL HOLDINGS S.A.	18/11/2021	201
526919	21/10/2022	BY PASS	25	ESE S.A.	09/11/2021	201
526920	21/10/2022	R-K3T	25 y 41	ESE S.A.	09/11/2021	201
526923	21/10/2022	BLIZZARD (mixta)	18	Soc. Com. Maletas Chile Ltda.	23/09/2021	94
526926	21/10/2022	EL MILAGRO (mixta)	4, 6, 19 y 37	CEFAS S.A.	22/10/2021	216
526927	21/10/2022	BARUM (mixta)	12 (S/D) y 17 (S/D)	Continental Barum s.r.o.	23/10/2021	221
526935	21/10/2022	LA CLARABOYA EXPRESSO (mixta)	43	LA CLARABOYA S.A.	03/09/2021	34
526936	21/10/2022	LOS CUERVOS (mixta)	18, 25, 28 y 41	CLUB DE GOLF DEL URUGUAY	26/10/2021	245
526941	21/10/2022	LUGAREÑO	33 (S/D)	ANTIGUA BODEGA STAGNARI S.A.	21/08/2021	189
526942	24/10/2022	TRY (mixta)	5	VARELA RADIO S.A.	23/08/2021	194
526944	24/10/2022	CUESTA DE GRAVA	33	ANTIGUA BODEGA STAGNARI S.A.	13/08/2021	189

N° Exp	Resolución	Denominación	Clases	Titular	Vigencia	Ag.
526971	24/10/2022	QUE HACEMOS HOY	16	OSCAR LAGARMILLA y ADRIANA PEREZ STEWART	10/08/2021	163
526973	24/10/2022	ORO (mixta)	3 (S/D)	QUIMICAS ORO, S.A.	21/11/2021	144
526974	24/10/2022	SIMBIOFLOR	5	SymbioGruppe GmbH & Co. KG	03/02/2022	144
526976	24/10/2022	MALZBIER	32 (S/D)	FNC S.A.	10/09/2021	144
526978	24/10/2022	POPULAR (mixta)	32 (S/D)	FNC S.A.	18/09/2021	144
526981	24/10/2022	SECUFEM	5	URUFARMA S.A.	11/01/2022	34
526983	24/10/2022	CORRE CAMINATA (mixta)	35 y 41	SHOPPING CENTER'S (URUGUAY) S.A.	13/01/2022	34
526984	24/10/2022	RHEEM	11 (S/D)	RHEEM MANUFACTURING COMPANY	18/09/2021	194
526985	24/10/2022	RHEEM	11 (S/D)	RHEEM MANUFACTURING COMPANY	18/09/2021	194
526987	24/10/2022	TATITOS (mixta)	41	SILVA PINTOS, DIEGO	05/09/2021	194
526988	24/10/2022	SWISS LIFE PRIVATE PLACEMENT	36	SWISS LIFE INTELLECTUAL PROPERTY MANAGEMENT AG.	18/08/2021	201
526989	24/10/2022	BIOS (mixta)	41	ALESSANDRO ANSELMO; FERNANDO CONDE y MARCELLO CONDE	30/01/2022	181
526991	07/11/2022	GE	2, 3, 4, 6, 8, 14, 16, 18, 19, 25, 28, 35, 36, 38, 39, 40, 41, 42, 43, 44 y 45	GENERAL ELECTRIC COMPANY	05/09/2021	194
526993	15/11/2022	BINAXNOW	1 (S/D) y 5 (S/D)	Abbott Rapid Diagnostics International Unlimited Company	09/08/2021	136
526994	24/10/2022	RESPIMAT	5 (S/D)	Boehringer Ingelheim Pharma GmbH & Co. KG	05/09/2021	201
526997	24/10/2022	NULEV	5	ICU-VITA S.A.	05/09/2021	201
526998	24/10/2022	CAMPUS CLINICA ODONTOLOGICA INTEGRAL (mixta)	44 (S/D)	NATROM S.A.	01/10/2021	201
527000	24/10/2022	VOLARXMENOS.COM	39	TOURNIER CAIROLI, SERGIO	05/08/2021	245

N° Exp	Resolución	Denominación	Clases	Titular	Vigencia	Ag.
527003	24/10/2022	VEGETALES CONT. NETO 55G 5 SOBRES DE 11G (mixta)	29 (S/D)	Knorr-Nährmittel Aktiengesellschaft	31/10/2021	136
527012	04/11/2022	ZENIT	21	ALEJANDRO SCHEIN	29/08/2021	144
527013	24/10/2022	STECK (mixta)	9	STECK INDUSTRIA ELETRICA LTDA.	30/11/2021	144
527014	24/10/2022	FANS	43	Marcelo Hoizman	12/08/2021	
527015	24/10/2022	ESPRIT (mixta)	25 (S/D)	ESPRIT INTERNATIONAL	30/09/2021	144
527021	24/10/2022	CABLE & WIRELESS	9, 16, 35, 36, 37, 38, 42, 43, 44 y 45	CABLE & WIRELESS TRADE MARK MANAGEMENT LIMITED	27/11/2021	34
527026	24/10/2022	PROTECTNET	9 (S/D)	Schneider Electric IT Corporation	22/02/2021	245
527028	25/10/2022	CANTRIMOL	5	BIOGENESIS BAGÓ S.A.	31/10/2021	34
527029	25/10/2022	BEROCCA ES-3	5	BAYER CONSUMER CARE AG	25/10/2021	205
527030	25/10/2022	POLICLOSTRIGEN	5	BIOGENESIS BAGÓ S.A.	31/10/2021	34
527031	25/10/2022	BIOQUERATOGEN	5	BIOGENESIS BAGÓ S.A.	31/10/2021	34
527033	25/10/2022	KAIKEN	33 (S/D)	MONTES S.A.	17/08/2021	219
527034	25/10/2022	BIOABORTOGEN	5	BIOGENESIS BAGÓ S.A.	31/10/2021	34
527035	25/10/2022	IBUPIRAC MIGRA	5	URUFARMA S.A.	17/01/2022	34
527036	25/10/2022	IBUPIRAC FLEX	5	URUFARMA S.A.	17/01/2022	34
527037	25/10/2022	ONEADAY (mixta)	5 (S/D)	BAYER INTELLECTUAL PROPERTY GmbH	22/10/2021	205
527038	25/10/2022	ELEVIT PRONATAL (mixta)	5 (S/D)	BAYER CONSUMER CARE AG.	09/10/2021	205
527043	25/10/2022	(tridimensional)	30	PEPSICO INC.	23/08/2021	201
527044	25/10/2022	NESTORONE	5 (S/D)	THE POPULATION COUNCIL, INC.	05/09/2021	194
527045	25/10/2022	(tridimensional)	30	PEPSICO, INC.	30/08/2021	201
527046	25/10/2022	(tridimensional)	30	PEPSICO, INC.	30/08/2021	201
527051	25/10/2022	INSPECTA SHIELD (mixta)	1	JORGE OMAR GOMEZ	10/08/2021	212
527052	25/10/2022	BANOX	31	ALLTECH DO BRASIL AGROINDUSTRIAL LTDA.	19/11/2021	201
527053	25/10/2022	TRETORN	18 (S/D)	TRETORN AKTIEBOLAG	16/09/2021	201
527054	25/10/2022	GREG NORMAN	33 (S/D)	ABG-Shark, LLC	06/10/2021	201
527056	25/10/2022	NAUTICA JEANS COMPANY N	25 (S/D)	NAUTICA APPAREL, INC.	28/11/2021	201

N° Exp	Resolución	Denominación	Clases	Titular	Vigencia	Ag.
		(mixta)				
527057	25/10/2022	NAUTICA JEANS N (mixta)	25 (S/D)	NAUTICA APPAREL, INC.	28/11/2021	201
527058	25/10/2022	CITIGROUP	36 (S/D)	Citigroup Inc.	05/09/2021	194
527059	03/11/2022	CITICONNECT	36	Citigroup Inc.	25/09/2021	194
527061	25/10/2022	ACTARA	5 (S/D)	SYNGENTA PARTICIPATIONS AG	06/09/2021	194
527062	25/10/2022	(figurativa)	1 (S/D), 5 (S/D) y 44	SYNGENTA PARTICIPATIONS AG	20/09/2021	194
527065	27/10/2022	BARON B (mixta)	32 (S/D) y 33 (S/D)	BODEGAS CHANDON S.A.	26/04/2021	192
527068	26/10/2022	NEW WAY	18	CASA JORGE S.R.L.	15/08/2021	212
527069	26/10/2022	SAN NICANOR	43 y 44	FLORES SILVESTRES S.A.	08/08/2021	94
527070	26/10/2022	AROMAS Y SABORES CLASES DE COCINA (mixta)	41	CORPORACION GASTRONOMICA DE PUNTA DEL ESTE	08/08/2021	201
527074	26/10/2022	MISOPROL	5	URUFARMA S.A.	25/01/2022	34
527075	26/10/2022	LORABREX	5	URUFARMA S.A.	10/01/2022	34
527077	26/10/2022	CELEBREX	5 (S/D)	G. D. SEARLE LLC	13/08/2021	34
527079	26/10/2022	GOLDEX (mixta)	1, 2, 4, 6, 11, 12, 13, 17, 18, 19, 20, 21, 22, 25, 27 y 28	JUAN GOLDFARB S.A.	26/11/2021	181
527082	26/10/2022	APRIL	5 (S/D)	LABORATORIO GADOR S.A.	05/09/2021	165
527083	26/10/2022	ADROCAL	5	LABORATORIO GADOR S.A.	12/09/2021	165
527084	26/10/2022	MEMOBRAL	5	LABORATORIO GADOR S.A.	14/09/2021	165
527085	26/10/2022	AMILOFUR	5 (S/D)	LABORATORIO GADOR S.A.	18/09/2021	165
527086	26/10/2022	ASPERSIN	5 (S/D)	BIOGENESIS BAGÓ S.A.	30/10/2021	34
527087	26/10/2022	VASODYNAM	5 (S/D)	LABORATORIO GADOR S.A.	18/09/2021	165
527088	26/10/2022	ARISTAZINA	5 (S/D)	LABORATORIO GADOR S.A.	18/09/2021	165
527089	27/10/2022	FORESTRUCK	42 (S/D)	WEST FOREST INGENIERIA LIMITADA	21/09/2021	234
527092	27/10/2022	INTEGRACION AFAP (mixta)	36	INTEGRACION AFAP S.A.	11/08/2021	94
527093	27/10/2022	AVEDA	3	AVEDA CORPORATION	09/08/2021	194
527094	27/10/2022	AMALAYA	33 (S/D)	Hess Family Estates AG	14/08/2021	194

N° Exp	Resolución	Denominación	Clases	Titular	Vigencia	Ag.
527102	27/10/2022	MOODY'S	36	MIS QUALITY MANAGEMENT CORP.	25/09/2021	245
527107	27/10/2022	AXE	41	Unilever Global IP Limited	26/11/2021	136
527108	27/10/2022	DUBBLE BUBBLE	30	Concord Brands ULC	06/02/2022	136
527112	27/10/2022	VETOQUINOL	5 (S/D)	VETOQUINOL S.A.	10/08/2021	154
527115	27/10/2022	ZARA	4	INDUSTRIA DE DISEÑO TEXTIL S.A. (INDITEX S.A.)	05/09/2021	201
527116	27/10/2022	ZARA	5	INDUSTRIA DE DISEÑO TEXTIL S.A. (INDITEX S.A.)	05/09/2021	201
527117	27/10/2022	ZARA BASIC	18 (S/D) y 25 (S/D)	INDUSTRIA DE DISEÑO TEXTIL, S.A. (INDITEX, S.A.)	17/10/2021	201
527118	27/10/2022	ZARA	25 (S/D)	INDUSTRIA DE DISEÑO TEXTIL, S.A. (INDITEX, S.A.)	22/10/2021	201
527123	27/10/2022	KWS (mixta)	31 (S/D) y 42 (S/D)	KWS Saat SE.	18/08/2021	144
527125	27/10/2022	MICRODOL	1 (S/D)	KODAK AMERICAS, LTD.	21/08/2021	165
527126	04/11/2022	FEBRIMICINA	5	LAZAR S.A.	05/09/2021	165
527127	27/10/2022	INTERVALO	30	DISGAL S.A.	20/09/2021	165
527128	27/10/2022	A ALVARO (mixta)	44 (S/D)	DIAGNOSTICOS DA AMERICA S/A	14/09/2021	34
527129	27/10/2022	CREALIMENTOS	30	DISGAL S.A.	30/09/2021	165
527130	27/10/2022	TRIGALVITA	30	EL TRIGAL S.A.	30/09/2021	165
527131	27/10/2022	ANIMAL PLANET	9 (S/D), 38 (S/D) y 41 (S/D)	Discovery Communications, LLC	21/02/2021	194
527133	27/10/2022	AREPANRIX	5 (S/D)	GLAXOSMITHKLINE BIOLOGICALS S.A.	30/09/2021	216
527134	27/10/2022	PANDEMRIX	5 (S/D)	GLAXOSMITHKLINE BIOLOGICALS S.A.	30/09/2021	216
527135	01/11/2022	CUSHE	25	Saucony UK, Inc.	21/09/2021	194
527136	27/10/2022	SERETIDE	5 (S/D)	GLAXO GROUP LIMITED	05/09/2021	216
527138	27/10/2022	FRUIT SALT	5 (S/D)	GlaxoSmithKline Consumer Healthcare (UK) IP Limited	18/09/2021	216
527139	27/10/2022	HINDS	1 (S/D), 3 (S/D), 6 (S/D), 8 (S/D), 22	GlaxoSmithKline Consumer Healthcare (UK) IP Limited	18/09/2021	216

N° Exp	Resolución	Denominación	Clases	Titular	Vigencia	Ag.
			(S/D) y 26 (S/D)			
527141	27/10/2022	A LABORATÓRIO ALVARO (mixta)	44 (S/D)	DIAGNOSTICOS DA AMERICA S/A	14/09/2021	34
527142	27/10/2022	PROGESTAN URUFARMA	5	URUFARMA S.A.	17/01/2022	34
527148	27/10/2022	SOALJO	42	ETUXEO S.R.L.	24/11/2021	34
527153	27/10/2022	SOALJO	35	ETUXEO S.R.L.	24/11/2021	34
527154	27/10/2022	SPARC	16 (S/D)	SAQUIERES PARADEDA S.A.	26/11/2021	245
527173	03/11/2022	ENERGÍA ES MC2 (mixta)	32	Julio Cesar Estable	23/08/2021	
527174	03/11/2022	LINK	10 (S/D)	Waldemar Link GmbH & Co. KG	16/08/2021	179
527178	03/11/2022	SPARK	32 y 33	BODEGAS CHANDON S.A.	03/08/2021	192
527181	03/11/2022	STORAGETEK	9, 16 y 42 (S/D)	Oracle America, Inc.	14/11/2021	192
527183	03/11/2022	CASA DE CAMPO	35, 36 y 37	SERGIO SESSA	12/10/2021	181
527184	03/11/2022	POWER BROUWER	5 (S/D)	BROUWER S.A.	16/12/2021	94
527185	03/11/2022	ARTRIN BROUWER	5 (S/D)	BROUWER S.A.	16/12/2021	94
527186	03/11/2022	MELTRA	5 (S/D)	BROUWER S.A.	16/12/2021	94
527187	03/11/2022	OYSTER PERPETUAL	14	ROLEX SA	31/10/2021	144
527188	03/11/2022	ORCHID	14	ROLEX SA	09/10/2021	144
527189	03/11/2022	IBUGESIC	5	Dinel S.A.	26/10/2021	144
527190	03/11/2022	VIVIRUM	5	SERVIMEDIC S.A.	26/10/2021	144
527191	03/11/2022	SEA-DWELLER	14	ROLEX SA	31/10/2021	144
527192	03/11/2022	GMT-MASTER	14	ROLEX SA	01/11/2021	144
527193	03/11/2022	AQUA DI MARE	3	TERRY S.A.	12/10/2021	144
527194	03/11/2022	SURPRISE	30	MANTRA S.A.	25/10/2021	144
527195	03/11/2022	CALIBRE DE CARTIER	14 (S/D)	CARTIER INTERNATIONAL AG	26/01/2022	144
527196	03/11/2022	PILSEN SONIC (mixta)	32	FNC SOCIEDAD ANONIMA	03/10/2021	144
527197	03/11/2022	PILSEN SONIC (mixta)	32	FNC SOCIEDAD ANONIMA	03/10/2021	144
527198	03/11/2022	PILSEN (mixta)	32 (S/D)	FNC SOCIEDAD ANONIMA	16/10/2021	144
527199	03/11/2022	NIASI	3 (S/D)	Coty Geneva S.A. Versoix	16/08/2021	34
527200	03/11/2022	RISQUE	3 (S/D)	Coty Geneva S.A. Versoix	16/08/2021	34
527202	03/11/2022	BOZZANO	3 (S/D), 8 (S/D), 22 (S/D) y 26 (S/D)	Coty Geneva S.A. Versoix	21/08/2021	34

N° Exp	Resolución	Denominación	Clases	Titular	Vigencia	Ag.
527205	03/11/2022	FREE	34	SOUZA CRUZ LTDA	06/09/2021	194
527210	03/11/2022	FEMME	3 (S/D)	INTERPARFUMS S.A.	23/10/2021	245
527211	03/11/2022	R (mixta)	3 (S/D) y 9 (S/D)	INTERPARFUMS S.A.	12/10/2021	245
527219	16/11/2022	BING	35 (S/D), 38 (S/D) y 42 (S/D)	MICROSOFT CORPORATION	18/11/2021	228
527220	03/11/2022	(figurativa)	9 (S/D)	MICROSOFT CORPORATION	18/11/2021	228
527224	03/11/2022	STEYR (mixta)	9 (S/D) y 11 (S/D)	MAGNA STEYR AG & CO. KG	18/09/2021	34
527225	03/11/2022	LA DOLOREÑA	3 y 30	CADOL (COOPEATIVA AGRARIA DE RESPONSABILIDAD LIMITADA)	05/10/2021	189
527226	04/11/2022	STEYR (mixta)	9 (S/D)	MAGNA STEYR AG & CO. KG	18/09/2021	34
527229	04/11/2022	OLICLINOMEL	5	BAXTER INTERNATIONAL INC.	09/10/2021	218
527240	04/11/2022	Z ZODIAC (mixta)	9 (S/D) y 12 (S/D)	ZPES HOLDING	02/09/2021	144
527246	04/11/2022	IU (mixta)	22 y 31	ASOCIACION RURAL DEL URUGUAY	23/01/2022	34
527250	04/11/2022	FLUSTAMIN	5 (S/D)	PRODUCTOS FARMACEUTICOS S.A. DE C.V.	09/01/2022	34
527251	04/11/2022	MIOSTAT	5	Alcon Inc.	20/11/2021	34
527252	04/11/2022	B S S	5	ALCON INC.	20/11/2021	34
527253	04/11/2022	LA SEMBRADORA	29 y 30	MILTON ARIEL MENDIETA AVELLANEDA	13/08/2021	129
527254	04/11/2022	DSA DISTRIBUIDORA SANTA ANA S.A. (mixta)	35 y 39	DISTRIBUIDORA SANTA ANA S.A.	14/08/2021	129
527255	04/11/2022	FOCUS	5 (S/D)	ALCON INC.	21/11/2021	34
527256	04/11/2022	BONNE MAMAN (mixta)	29 (S/D) y 30 (S/D)	ANDROS	05/09/2021	245
527259	04/11/2022	JIM THOMPSON	24 (S/D)	THE THAI SILK COMPANY LIMITED	05/09/2021	156
527266	04/11/2022	LIMONETO	32 (S/D)	PORTFOLIO CONCENTRATE SOLUTIONS UNLIMITED COMPANY	12/09/2021	201
527267	04/11/2022	IXIARO	5 (S/D)	VALNEVA AUSTRIA GmbH	14/09/2021	201
527268	04/11/2022	CANELITAS	30	GRUPO BIMBO S.A.B. DE C.V.	19/03/2021	181
527269	04/11/2022	ROMANCE	33	ROSES HNOS. S.R.L.	17/08/2021	201
527270	04/11/2022	(figurativa)	3 (S/D) y 21 (S/D)	Unilever Global IP Limited	28/11/2021	136

N° Exp	Resolución	Denominación	Clases	Titular	Vigencia	Ag.
527271	04/11/2022	BARCEL QUEZAS	30	GRUPO BIMBO S.A.B. DE C.V.	24/03/2021	181
527274	04/11/2022	BULL DOG (mixta)	1 (S/D), 2 (S/D), 8 (S/D) y 19 (S/D)	COMPAÑIA ORIENTAL DE MINERALES S.A. (C.O.M.S.A.)	21/08/2021	
527276	04/11/2022	PENTA HOTELERIA ABIERTA (mixta)	39 y 43 (S/D)	REGALTUR S.A.	15/08/2021	94
527280	04/11/2022	INIA KANOPUS	31	INSTITUTO NACIONAL DE INVESTIGACIONAGROPECUARIA (INIA)	10/09/2021	34
527282	04/11/2022	PRIMOR	1 (S/D), 5 (S/D), 7 (S/D), 18 (S/D), 20 (S/D), 21 (S/D), 22 (S/D), 29 (S/D), 30 (S/D) y 31 (S/D)	COMPAÑIA OLEAGINOSA URUGUAYA S.A.	23/10/2021	144
527283	04/11/2022	GUASTAVINO	28	GASTON SIMI BARCELO	18/11/2021	212
527284	04/11/2022	REGIO (mixta)	29 (S/D)	COMPAÑIA OLEAGINOSA URUGUAYA S.A.	28/10/2021	144
527286	04/11/2022	EL TORERO (mixta)	29 (S/D)	COMPAÑIA OLEAGINOSA URUGUAYA S.A.	28/10/2021	144
527287	04/11/2022	URUGUAY (mixta)	29 (S/D)	ACEITERAS DEL URUGUAY Y CIDAC UNIDAS S.A.	28/10/2021	144
527288	04/11/2022	SARANDI	32 (S/D) y 33 (S/D)	ACEITERAS DEL URUGUAY Y CIDAC UNIDAS S.A.	28/10/2021	144
527289	04/11/2022	MOLINOS SAN JOSE S.A. (mixta)	29 y 31	MOLINOS SAN JOSE S.A.	19/10/2021	144
527298	04/11/2022	POSNET (mixta)	9, 36 y 38	POSNET S.R.L.	19/08/2021	201
527299	04/11/2022	MERCADO NATURAL (mixta)	30 y 31	NICOLAS AZPEITIA	17/08/2021	212
527300	04/11/2022	MANSIL	5 (S/D)	URUFARMA S.A.	07/02/2022	34
527306	07/11/2022	VALDA	5 (S/D)	PALCATES S.A.	31/01/2022	34
527312	07/11/2022	CEFA-SEC	5	AGROVET MARKET S.A.	29/11/2021	189
527317	07/11/2022	NIGALAX	5	LABORATORIO GADOR S.A.	05/10/2021	165
527318	07/11/2022	CITOXAN	5	LABORATORIO GADOR S.A.	21/10/2021	165
527319	07/11/2022	DOCEXAN	5	LABORATORIO GADOR S.A.	26/10/2021	165
527320	07/11/2022	ZINDOFEN	5	LABORATORIO GADOR S.A.	29/10/2021	165

N° Exp	Resolución	Denominación	Clases	Titular	Vigencia	Ag.
527321	07/11/2022	ENDOCLENS-NSX	5 (S/D) y 10 (S/D)	ASP GLOBAL MANUFACTURING GmbH	23/08/2021	194
527322	07/11/2022	PERRY ELLIS AMERICA	9 (S/D) y 25 (S/D)	PERRY ELLIS INTERNATIONAL EUROPE LIMITED	30/08/2021	194
527323	07/11/2022	PERRY ELLIS	9 (S/D) y 25 (S/D)	PERRY ELLIS INTERNATIONAL EUROPE LIMITED	30/08/2021	194
527324	07/11/2022	PERRY ELLIS PORTFOLIO	9 (S/D) y 25 (S/D)	PERRY ELLIS INTERNATIONAL EUROPE LIMITED	30/08/2021	194
527326	07/11/2022	WIRE-TECH (mixta)	9 (S/D)	WIRE TECH S.A.	23/08/2021	201
527330	07/11/2022	ÁTILA (mixta)	31	HERCOSUL ALIMENTOS LTDA.	27/12/2021	201
527331	07/11/2022	APOLO (mixta)	31	HERCOSUL ALIMENTOS LTDA.	27/12/2021	201
527332	07/11/2022	ADORE (mixta)	31	HERCOSUL ALIMENTOS LTDA.	27/12/2021	201
527333	07/11/2022	BENTLEY	25 (S/D)	LIGHTNING BOLT S.A.	23/10/2021	201
527336	07/11/2022	(tridimensional)	3 (S/D)	LVMH Fragrance Brands	06/09/2021	245
527337	07/11/2022	HOT COUTURE	3 (S/D)	LVMH Fragrance Brands	19/11/2021	245
527342	07/11/2022	MM MUNDOMADERA (mixta)	19 y 20	SELCAR S.A	16/10/2021	212
527344	07/11/2022	PRÓXIMO SIEMPRE CERCA (mixta)	36 y 38	CAFIDUR S.A.	30/09/2021	219
527345	07/11/2022	PRONIVIS	5 (S/D)	MERCK KGaA	19/08/2021	129
527346	07/11/2022	STREK	5	LABORATORIO LIBRA SOCIEDAD ANONIMA	23/08/2021	129
527348	07/11/2022	UNIR	5	LABORATORIO LIBRA SOCIEDAD ANONIMA	23/08/2021	129
527349	07/11/2022	SAINT PERE	33	LANECOR S.A.	22/08/2021	219
527355	07/11/2022	KINOA CRACKERS	30	DISGAL S.A.	02/10/2021	165
527356	07/11/2022	BIZCOTITA	30	DISGAL S.A.	17/10/2021	165
527357	07/11/2022	URUGUAYITAS DE FRUTIGRAN	30	EL TRIGAL S.A.	19/10/2021	165
527361	08/11/2022	TIGER MARKET (mixta)	35, 43, 44 y 45	Exxon Mobil Corporation	17/10/2021	136
527364	08/11/2022	TIGER MARKET (mixta)	35, 43, 44 y 45	Exxon Mobil Corporation	17/10/2021	136
527365	08/11/2022	REXONA CLINICAL	3 (S/D)	Unilever Global IP Limited	07/12/2021	136
527369	08/11/2022	LP (mixta)	28 (S/D)	La Pointique International, Ltd.	21/11/2021	136

N° Exp	Resolución	Denominación	Clases	Titular	Vigencia	Ag.
527371	08/11/2022	SNAPFROST	33 (S/D)	DIAGEO BRANDS B.V.	06/10/2021	212
527373	08/11/2022	VOGUE (mixta)	9 (S/D)	Advance Magazine Publishers, Inc.	06/09/2021	136
527374	08/11/2022	CAMPO TV (mixta)	38	CYLENE S.A.	17/08/2021	181
527376	08/11/2022	BLACKBURN	33	DIAGEO BRANDS B.V.	27/12/2021	212
527379	08/11/2022	RED LABEL (mixta)	33	DIAGEO BRANDS B.V.	19/12/2021	212
527380	16/11/2022	TEKOX (mixta)	9 (S/D)	TÉCNICA DE CONEXIONES, S.A.	04/01/2022	216
527381	08/11/2022	(figurativa)	33 (S/D)	DIAGEO BRANDS B.V.	07/10/2021	212
527383	08/11/2022	BLACK LABEL	33 (S/D)	DIAGEO BRANDS B.V.	19/12/2021	212
527393	16/11/2022	PLUSPAN	30 (S/D)	LESAFFRE ET COMPAGNIE	26/11/2021	144
527404	08/11/2022	DILUPLAST	17	ACQUEDOTTO S.A.	19/01/2022	192
527405	08/11/2022	GREENWICH INSTITUTE - THE RIGHT TIME FOR YOUR ENGLISH (mixta)	41 (S/D)	YANINA ROBAINA MORENO	12/09/2021	94
527406	08/11/2022	WAIS	9 y 42	SERGIO ROBERTO PODESTA CARRATO	21/02/2021	192
527407	08/11/2022	LOSTAMUCIL	5	LABORATORIOS TEMIS LOSTALÓ S.A.	19/08/2021	192
527408	08/11/2022	(figurativa)	30 (S/D)	JUST BORN, INC.	30/08/2021	194
527411	16/11/2022	L'HIRONDELLE LA GOLONDRINA THE SWALLOW (mixta)	30 (S/D)	LESAFFRE ET COMPAGNIE	21/11/2021	144
527412	16/11/2022	GB (mixta)	30 (S/D)	LESAFFRE ET COMPAGNIE	19/12/2021	144
527413	08/11/2022	RED STAR (mixta)	30	LESAFFRE ET COMPAGNIE	19/12/2021	144
527414	08/11/2022	NOVAISO	20	PRONTOMETAL S.A.	19/12/2021	144
527415	08/11/2022	NORTEÑA (mixta)	32 (S/D)	FNC SOCIEDAD ANONIMA	21/11/2021	144
527416	08/11/2022	CERVEZA ESPECIAL PILSEN	32 (S/D)	FNC SOCIEDAD ANÓNIMA	28/11/2021	144
527417	08/11/2022	CERVEZA RUBIA TIPO DRY PILSEN SONIC IND. URUGUAYA CONT. NETO 330ML (mixta)	32 (S/D)	FNC SOCIEDAD ANONIMA	21/11/2021	144
527418	08/11/2022	NESINA	5 (S/D)	TAKEDA PHARMACEUTICAL COMPANY LIMITED	16/09/2021	156

N° Exp	Resolución	Denominación	Clases	Titular	Vigencia	Ag.
527421	08/11/2022	T TERUMO (mixta)	10	TERUMO KABUSHIKI KAISHA (TERUMO CORPORATION)	28/01/2022	156
527423	08/11/2022	MOLESKINE	16	MOLESKINE S.R.L.	12/09/2021	245
527434	08/11/2022	HAEMONETICS	9 (S/D) y 10 (S/D)	Haemonetics Corporation	23/08/2021	136
527436	24/11/2022	DRIVE	3 (S/D)	Unilever Global IP Limited	19/12/2021	136
527437	16/11/2022	SPARC	9 (S/D)	SPARC International, Inc.	12/11/2021	136
527463	16/11/2022	LEE'S	3 (S/D), 4 (S/D), 6 (S/D), 8 (S/D), 9 (S/D), 10 (S/D), 12 (S/D), 14 (S/D), 16 (S/D), 17 (S/D), 18 (S/D), 20 (S/D), 21 (S/D), 22 (S/D), 23 (S/D), 24 (S/D), 26 (S/D) y 28 (S/D)	The H.D. Lee Company, Inc.	23/10/2021	194
527464	16/11/2022	STARBUCKS VIA	30 (S/D)	STARBUCKS CORPORATION	03/10/2021	34
527477	17/11/2022	GENESIS ULTRA POUR-ON FOR CATTLE (mixta)	5 (S/D)	Boehringer Ingelheim Vetmedica GmbH	05/10/2021	245
527478	16/11/2022	CERTIFECT	5 (S/D)	Boehringer Ingelheim Vetmedica GmbH	29/12/2021	245
527479	16/11/2022	DIABESEL	5	Instituto Botánico La Selva S.A.	12/10/2021	205
527481	16/11/2022	ROAMER (mixta)	14 (S/D)	ROAMER WATCH CO. S.A.	18/09/2021	201
527484	16/11/2022	TATOOMANIA	16 (S/D) y 28 (S/D)	PEPSICO INC.	19/09/2021	201
527485	21/11/2022	SHISEIDO (mixta)	35, 42, 43, 44 y 45	SHISEIDO COMPANY, LIMITED	25/09/2021	201
527486	21/11/2022	COLGATE EXTREME	21 (S/D)	COLGATE-PALMOLIVE COMPANY	25/09/2021	201
527488	21/11/2022	TROPICANA (mixta)	32 (S/D)	TROPICANA PRODUCTS, INC.	30/09/2021	201
527489	21/11/2022	DIRI	35	PARRA HERMANOS SRL	21/08/2021	19
527492	21/11/2022	CASAPUEBLO (mixta)	3, 16, 19, 21, 25, 30, 32, 33, 38, 41 y 42	TINSATUR S.A.	14/11/2021	212
527493	21/11/2022	TEFLON	1 (S/D)	THE CHEMOURS COMPANY FC, LLC	18/09/2021	34
527495	21/11/2022	LETROZ	5	LABORATORIO LIBRA SOCIEDAD ANONIMA	23/08/2021	129

N° Exp	Resolución	Denominación	Clases	Titular	Vigencia	Ag.
527496	21/11/2022	TEFLON	2 (S/D)	THE CHEMOURS COMPANY FC, LLC	18/09/2021	34
527497	21/11/2022	FOSET	11 (S/D)	TRUPER, S.A. DE C.V.	26/08/2021	144
527498	21/11/2022	GEMCITAC	5	LABORATORIO LIBRA SOCIEDAD ANONIMA	23/08/2021	129
527499	21/11/2022	PRETUL	6 (S/D), 7 (S/D), 8 (S/D) y 9 (S/D)	TRUPER, S.A. DE C.V.	29/08/2021	144
527501	21/11/2022	TEFLON	9 (S/D)	THE CHEMOURS COMPANY FC, LLC	18/09/2021	34
527502	21/11/2022	DORMIZOLAM	5	LABORATORIO LIBRA SOCIEDAD ANONIMA	23/08/2021	129
527503	21/11/2022	DOBUTAM	5	LABORATORIO LIBRA SOCIEDAD ANONIMA	23/08/2021	129
527507	21/11/2022	TRES FLORES ALIMENTOS ENVASADOS (mixta)	30	HORACIO MOREIRA AVONDET	30/08/2021	163
527511	21/11/2022	POWER STROKE	12 (S/D)	FORD MOTOR COMPANY	23/08/2021	194
527513	21/11/2022	CLUB DEL LAGO HOTEL (mixta)	3 y 25	Club del Lago S.A.D	04/10/2021	181
527514	21/11/2022	ALLIANZ (mixta)	36	ALLIANZ SE	25/10/2021	194
527515	21/11/2022	CRISOLES	2 (S/D)	CRISOLES S.A.	09/10/2021	245
527517	21/11/2022	IODAMIC	5	LABORATORIOS MICROSULES URUGUAY S.A.	22/08/2021	
527518	21/11/2022	MOXIMIC	5	LABORATORIOS MICROSULES URUGUAY S.A.	22/08/2021	
527519	21/11/2022	VERMEX	5 (S/D)	LABORATORIOS MICROSULES URUGUAY S.A.	22/08/2021	
527521	21/11/2022	POINT ZERO	25	EL HOGAR DE LAS MEDIAS S.A.	01/09/2021	245
527533	21/11/2022	MILLEFIORI	3	COSMETICA NACIONAL S.A.	14/09/2021	194
527534	21/11/2022	MERCADEO A.D.M.	16	Asociación de Dirigentes de Marketing del Uruguay	25/10/2021	167
527535	21/11/2022	CLSE SANTA ELENA (mixta)	41	VIC LTDA	22/08/2021	101
527536	21/11/2022	(figurativa)	41	VIC LTDA	16/12/2021	101
527537	21/11/2022	KESINT	5	LABORATORIO LIBRA SOCIEDAD ANONIMA	23/08/2021	129

N° Exp	Resolución	Denominación	Clases	Titular	Vigencia	Ag.
527538	21/11/2022	ANASTROL	5 (S/D)	LABORATORIO LIBRA SOCIEDAD ANONIMA	23/08/2021	129
527539	21/11/2022	MEROPREM	5	LABORATORIO LIBRA SOCIEDAD ANONIMA	23/08/2021	129
527541	21/11/2022	SHUANGXI (mixta)	34 (S/D)	CTBAT International Co Limited	22/09/2021	194
527542	21/11/2022	PALACIO DE LA MUSICA	38	VITONOR S.A.	21/08/2021	94
527543	22/11/2022	PALACIO DE LA MUSICA	41	VITONOR S.A.	21/08/2021	94
527547	21/11/2022	NITRODOM DOMINGUEZ	5	LABORATORIOS DOMINGUEZ S.A.	30/08/2021	144
527550	21/11/2022	OPTICA FRANCESA (mixta)	9 y 44	Arinclass S.A	20/05/2021	
527551	21/11/2022	5 RAICES (mixta)	32 y 33	CEPAS URUGUAY BEBIDAS Y ALIMENTOS S.A.	03/09/2021	34
527552	21/11/2022	AROPOL	1 (S/D)	INEOS COMPOSITES IP, LLC	22/02/2021	194
527555	21/11/2022	AEROMAR	35 y 36	DALMATEN S.A.	25/10/2021	245
527577	21/11/2022	JACK DANIEL'S (mixta)	32 (S/D) y 33 (S/D)	JACK DANIEL'S PROPERTIES, INC.	03/12/2021	192
527578	21/11/2022	JACK DANIEL'S	43 (S/D)	JACK DANIEL'S PROPERTIES, INC.	11/01/2022	192
527580	21/11/2022	ENERGIZER (mixta)	9	EVEREADY BATTERY COMPANY INC.	30/08/2021	194
527581	21/11/2022	EVEREADY GOLD	9 (S/D)	EVEREADY BATTERY COMPANY INC.	19/09/2021	194
527590	21/11/2022	SYMBION	5	P&G Health Germany GmbH	05/09/2021	216
527591	21/11/2022	(figurativa)	9, 16, 35, 36, 38, 39 y 42	MASTERCARD INTERNATIONAL INCORPORATED	22/06/2021	216
527593	21/11/2022	H TV (mixta)	38 y 41	HTV, LLC.	23/06/2021	216
527594	21/11/2022	OUROFINO AGRONEGÓCIO (mixta)	31 (S/D)	OURO FINO SAÚDE ANIMAL LTDA.	07/07/2021	144
527595	21/11/2022	OUROFINO AGRONEGÓCIO (mixta)	31 (S/D)	OURO FINO SAUDE ANIMAL LTDA.	07/07/2021	144
527596	21/11/2022	TCM CLASSIC ENTERTAINMENT	38 y 41	TURNER CLASSIC MOVIES, INC.	21/06/2021	216
527598	22/11/2022	20 STRAND KING SIZE, STRAND, 20 STRAND KING SIZE, STRAND (mixta)	34	HONGTA TOBACCO (GROUP) CO., LTD.	30/09/2021	216
527599	22/11/2022	BRASS, BRASS, BRASS, BRASS, BRASS, FINE TOBACCOS, FINE	34	HONGTA TOBACCO (GROUP) CO., LTD.	30/09/2021	216

N° Exp	Resolución	Denominación	Clases	Titular	Vigencia	Ag.
		TOBACCOS (mixta)				
527601	22/11/2022	TONY ROMA'S	43	ROMA SYSTEMS, INC.	25/10/2021	144
527602	22/11/2022	RECORD	8 (S/D)	The Black & Decker Corporation	05/07/2021	216
527603	22/11/2022	STAGES	21	THE GILLETTE COMPANY LLC	19/09/2021	216
527606	22/11/2022	SKODA (mixta)	12 (S/D)	SKODA AUTO A.S.	23/10/2021	34
527610	22/11/2022	SYN	16	SANTHER - FABRICA DE PAPEL SANTA THEREZINHA S.A.	04/09/2021	34
527614	16/11/2022	BABY SEC	16	CMPC TISSUE S.A.	20/11/2021	221
527615	22/11/2022	AA (mixta)	39	American Airlines, Inc.	20/11/2021	136
527616	16/11/2022	BABYSEC	3	CMPC TISSUE S.A.	09/10/2021	221
527617	22/11/2022	AADVANTAGE (mixta)	39	American Airlines, Inc.	20/11/2021	136
527619	16/11/2022	BABY SEC	25	CMPC TISSUE S.A.	16/10/2021	221
527621	22/11/2022	(figurativa)	12 (S/D)	SUBARU CORPORATION	31/01/2022	156
527622	22/11/2022	COUNTY (mixta)	12	HYUNDAI MOTOR COMPANY	26/10/2021	216
527624	22/11/2022	GPS	12	THE GOODYEAR TIRE & RUBBER COMPANY	09/11/2021	216
527626	22/11/2022	(figurativa)	9 (S/D), 16 (S/D), 35 (S/D), 36 (S/D), 38 (S/D) y 42 (S/D)	AT&T INTELLECTUAL PROPERTY II, L.P.	05/04/2021	216
527628	16/11/2022	ELITE R (mixta)	16	CMPC TISSUE S.A.	13/09/2021	221
527631	22/11/2022	GYQ	17 y 19	GARCÍA Y QUINTANA LTDA.	26/08/2021	129
527633	22/11/2022	TIRAPU (mixta)	39	TIRAPU S.A.	23/09/2021	194
527639	22/11/2022	GO. VISA	36 (S/D)	VISA INTERNATIONAL SERVICE ASSOCIATION	30/09/2021	156
527640	22/11/2022	ARTICO	29	DANILO CORDONE	25/10/2021	144
527646	22/11/2022	AFLURIA	5 (S/D)	CSL LIMITED	29/09/2021	194
527654	22/11/2022	ALMA DE FLORES	3	MEMPHIS S/A INDUSTRIAL	14/02/2022	194
527682	22/11/2022	HEMAX	5	BIOSIDUS S.A.	20/11/2021	201
527683	22/11/2022	LANVIN PARFUMS (mixta)	3 (S/D)	INTERPARFUMS SUISSE Sàrl	03/12/2021	144
527684	22/11/2022	EUROPA EUROPA	38 y 41	AMC NETWORKS ARGENTINA S.C.A.	28/11/2021	201

N° Exp	Resolución	Denominación	Clases	Titular	Vigencia	Ag.
527686	22/11/2022	HIPERINA	5	EUROFARMA URUGUAY S.A.	22/10/2021	201
527688	22/11/2022	OPTIVIEW	10 (S/D)	JOHNSON & JOHNSON	21/09/2021	194
527692	22/11/2022	TRACLEER	5 (S/D)	Actelion Pharmaceuticals Ltd.	17/09/2021	194
527693	22/11/2022	SIEMPRE LIBRE ADAPT	5 (S/D)	JOHNSON & JOHNSON	12/10/2021	194
527695	22/11/2022	INTERCEED	5	JOHNSON & JOHNSON	25/10/2021	194
527696	22/11/2022	SOYVIDA	29, 30, 32 y 33	BARRACA DEAMBROSI S.A.	30/08/2021	154
527698	22/11/2022	CAREFREE	5 (S/D)	JOHNSON & JOHNSON	09/10/2021	194
527699	22/11/2022	TRANSIT	10 (S/D)	Codman & Shurtleff, Inc.	19/10/2021	194
527700	22/11/2022	BELLIS	5 (S/D)	BASF SE	31/10/2021	194
527701	22/11/2022	STUGERON	5 (S/D)	JANSSEN PHARMACEUTICA N.V.	23/10/2021	194
527702	22/11/2022	OROS	5 y 10	ALZA CORPORATION	25/10/2021	194
527703	22/11/2022	EXUVIANCE	3 (S/D)	JOHNSON & JOHNSON	12/10/2021	194
527704	22/11/2022	TEMPLETON	36	TEMPLETON GLOBAL ADVISORS LIMITED	25/10/2021	201
527705	22/11/2022	CAMERATTA	16	MILI S.A.	30/08/2021	201
527706	22/11/2022	HYSORB (mixta)	1 (S/D)	BASF SE	31/10/2021	194
527707	22/11/2022	RESIDENCE	16	MILI S.A.	30/08/2021	201
527708	22/11/2022	ZIDUA	1 (S/D) y 5 (S/D)	BASF SE	10/11/2021	194
527709	22/11/2022	XEMIUM	1 (S/D) y 5 (S/D)	BASF SE	14/11/2021	194
527711	23/11/2022	CARRASCO LAWN TENNIS CLUB (mixta)	16, 25, 28 y 41	CARRASCO LAWN TENNIS	01/10/2021	201
527742	23/11/2022	ONEZIP	16 (S/D)	REYNOLDS CONSUMER PRODUCTS LLC.	05/09/2021	34
527746	23/11/2022	LAVENDER GIFTS & TEA ROOM (mixta)	35 y 43	CUMMINS VARELA, MAUREEN C.	05/09/2021	194
527749	23/11/2022	DULCYPAS	30	DULCYPAS S.A.	05/09/2021	245
527753	23/11/2022	CLIPPER	4	FLAMAGAS S.A.	15/11/2021	212
527763	23/11/2022	SOA	41	HONIGSBERG WEISZ, VIVIAN	01/02/2022	189
527779	23/11/2022	DURASOL (mixta)	22	LOCOMOTIVA DA AMAZONIA INDUSTRIA E COMERCIO DE	30/08/2021	201

N° Exp	Resolución	Denominación	Clases	Titular	Vigencia	Ag.
				TEXTEIS INDUSTRIAIS LTDA.		
527781	23/11/2022	PERFEX	5 (S/D)	QUIMICA AMPARO LTDA.	03/09/2021	94
527782	23/11/2022	SOMMIERCENTER (mixta)	35	RIDAR S.A.	15/12/2021	144
527783	23/11/2022	NTN24	38 y 41	NTN24 S.A.S	02/12/2021	34
527786	23/11/2022	NTN NUESTRA TELE NOTICIAS	38 y 41	NTN24 S.A.S	05/12/2021	34
527790	23/11/2022	NOVATECK	12 (S/D) y 17 (S/D)	PIRELLI TYRE S.P.A.	09/10/2021	192
527793	23/11/2022	BLACK RIVER STURGEON	29 (S/D)	Esturiones del Rio Negro S.A.	30/08/2021	101
527794	23/11/2022	BLACK RIVER CAVIAR	29 (S/D)	Esturiones del Rio Negro S.A.	30/08/2021	101
527795	23/11/2022	PANAVIR	5	DELIBRA S.A.	05/09/2021	245
527796	23/11/2022	VITACNE	5 (S/D)	DELIBRA S.A.	05/09/2021	245
527803	23/11/2022	AEO	3 (S/D), 14 (S/D), 18 (S/D) y 35 (S/D)	RETAIL ROYALTY COMPANY	21/10/2021	194
527804	23/11/2022	AMERICAN EAGLE OUTFITTERS	3 (S/D) y 14 (S/D)	RETAIL ROYALTY COMPANY	21/10/2021	194
527805	23/11/2022	AMERICAN EAGLE	3 (S/D), 14 (S/D), 25 (S/D) y 35 (S/D)	RETAIL ROYALTY COMPANY	24/11/2021	194
527806	23/11/2022	AE	3 (S/D), 14 (S/D), 18 (S/D) y 35 (S/D)	RETAIL ROYALTY COMPANY	07/12/2021	194
527821	23/11/2022	NET2PHONE	9 (S/D) y 38 (S/D)	NET2PHONE, INC.	19/03/2021	245
527822	24/11/2022	TOMMY (mixta)	30 (S/D)	PANDURATA ALIMENTOS LTDA.	29/09/2021	245
527823	24/11/2022	ALPENLIEBE (mixta)	30 (S/D)	PERFETTI VAN MELLE S.P.A.	19/10/2021	245
527824	24/11/2022	KLINER	21	SINDATEL S.A.	04/09/2021	94
527825	24/11/2022	LA MARTINA	21	SINDATEL S.A.	02/12/2021	94
527826	24/11/2022	SPINE & PRESE S&P	9	INDUSTRIAS ELDER TAVARES S.A.	19/10/2021	245
527828	24/11/2022	LA FAROLA	43 y 45	CANOSA, MANUEL y RODRIGUEZ APARICIO JOSE HECTOR	05/09/2021	144
527839	24/11/2022	AURORA (mixta)	12 (S/D)	HANKOOK TIRE WORLDWIDE CO., LTD.	25/10/2021	34
527841	24/11/2022	PULVER (mixta)	5 (S/D), 29 y 30	PULVER S.R.L.	09/01/2022	34
527843	24/11/2022	AIRLOCK	9 (S/D)	Marchon Eyewear, Inc.	19/09/2021	136
527844	24/11/2022	NATUCOR	3	VARGAS REENGENHARIA	12/09/2021	34

N° Exp	Resolución	Denominación	Clases	Titular	Vigencia	Ag.
				INDUSTRIALIZAÇÃO COMERCIALIZAÇÃO LTDA.		
527845	24/11/2022	HAIRLIFE	3	VARGAS REENGENHARIA INDUSTRIALIZAÇÃO COMERCIALIZAÇÃO LTDA.	12/09/2021	34
527848	24/11/2022	MAXTON	3	VARGAS REENGENHARIA INDUSTRIALIZAÇÃO COMERCIALIZAÇÃO LTDA.	12/09/2021	34
527850	24/11/2022	SEMPREBELLA	3	VARGAS REENGENHARIA INDUSTRIALIZAÇÃO COMERCIALIZAÇÃO LTDA.	12/09/2021	34
527851	24/11/2022	CD CARDFIELD	9 (S/D), 38 y 42	TENFIELD S.A.	04/10/2021	34
527853	24/11/2022	ESTAMPA	31	SOCIEDAD ELABORADORA DE ACEITES S.E.D.A. PRODUCTORA I. Y C.S.A.	07/10/2021	34
527870	01/11/2022	PARKING BAIRE	39	LECELINK S.A.	02/09/2021	94
527873	24/11/2022	VANDOREN (mixta)	15 (S/D)	VARLEPIC PARTICIPATIONS	21/10/2021	144
527884	24/11/2022	TOP TECNOLOGÍA OSMOPROTECTORA (mixta)	1	RIZOBACTER ARGENTINA S.A.	01/03/2022	34
527896	01/11/2022	BRELA JOYAS	14 (S/D)	RAUL LAFFITE & CIA. S.A.	28/12/2021	201
527900	01/11/2022	KIDY (mixta)	25	KIDY BIRIGUI CALÇADOS INDÚSTRIA E COMÉRCIO LTDA	05/09/2021	201
527905	01/11/2022	TELEMUNDO DOMINICAL	35, 38 y 41	SOCIEDAD TELEVISORA LARRAÑAGA S.A.	09/10/2021	241
527906	01/11/2022	TELEMUNDO INVESTIGA (mixta)	35, 38 y 41	SOCIEDAD TELEVISORA LARRAÑAGA S.A.	09/10/2021	241
527910	01/11/2022	ALKLIN (mixta)	21	SCHWANKE INDUSTRIAL LTDA.	06/09/2021	234
527918	01/11/2022	SADIA	29 y 30	BRF Singapore Foods PTE Limited	05/09/2021	94
527920	01/11/2022	BOTOX	5 (S/D)	ALLERGAN INC.	22/10/2021	201
527922	01/11/2022	LA ADRIATICA	30 (S/D)	ODDONE & GALLO	23/10/2021	144
527923	01/11/2022	IMNOSIS (mixta)	25	CLAUDIA AYUP	06/09/2021	220

N° Exp	Resolución	Denominación	Clases	Titular	Vigencia	Ag.
527924	01/11/2022	POZURDEX	5 (S/D)	ALLERGAN, INC.	15/11/2021	201
527926	01/11/2022	RESTASIS	5 (S/D)	ALLERGAN INC.	25/10/2021	201
527927	01/11/2022	REFRESH TEARS	5 (S/D)	ALLERGAN INC.	16/10/2021	201
527929	01/11/2022	CAMPO VERDE	29 y 30	IGOR PLAST S.A.	05/09/2021	220
527930	01/11/2022	FLOR DE CAMPO	29 y 30	IGOR PLAST S.A.	05/09/2021	220
527931	01/11/2022	REFRESH	5 (S/D)	ALLERGAN INC.	22/10/2021	201
527932	24/11/2022	UVEX BY SPERIAN (mixta)	2 (S/D), 9 (S/D) y 35 (S/D)	Honeywell Safety Products USA, Inc.	02/09/2021	34
527933	01/11/2022	BIANCO	1, 17 y 19	OTTO BAUMGART INDUSTRIA E COMERCIO S/A	16/10/2021	34
527936	01/11/2022	EXTRA VIDA SERIE XV	4 (S/D)	YPF SOCIEDAD ANONIMA	05/09/2021	34
527937	01/11/2022	EXTRA VIDA XV300	4 (S/D)	YPF SOCIEDAD ANONIMA	25/10/2021	34
527939	01/11/2022	MAROLIO	30	MAXICONSUMO S.A.	05/09/2021	201
527940	01/11/2022	MAGEFESA	11 y 21	CANTRA S.L.	14/02/2022	34
527941	01/11/2022	PEPSICO SNACKS (mixta)	29 y 30 (S/D)	PEPSICO, INC.	01/10/2021	201
527942	01/11/2022	COMLOT (mixta)	35 (S/D)	NITEBAN S.A.	14/10/2021	245
527943	01/11/2022	PEPSICO SNACKS (mixta)	29 y 30 (S/D)	PEPSICO, INC.	01/10/2021	201
527944	01/11/2022	LODEN HAUS	25	MARIA SILVIA ELUSPURU y CECILIA BELLUCCI	08/09/2021	34
527950	01/11/2022	GRANJA LA NATURALEZA LTDA. (mixta)	29 (S/D) y 44 (S/D)	GRANJA LA NATURALEZA LTDA.	17/09/2021	179
527952	01/11/2022	SWITCH SOFTWARE SOLUTIONS (mixta)	9 (S/D) y 42 (S/D)	INTEGRALSS S.R.L.	26/12/2021	179
527954	01/11/2022	(figurativa)	33 (S/D)	Glen Turner Company Limited	04/03/2021	192
527956	01/11/2022	CHAMPION	12 (S/D)	BABAT BURCATOVSKY, GREGORIO	08/09/2021	189
527957	01/11/2022	MOL	39 (S/D)	Kabushiki Kaisha Shosen Mitsui (Mitsui O.S.K. Lines, Ltd.)	09/10/2021	192
527958	01/11/2022	NETSUI O.S.K. LINES (mixta)	39 (S/D)	Kabushiki Kaisha Shosen Mitsui (Mitsui O.S.K. Lines, Ltd.)	09/10/2021	192
527959	01/11/2022	PASAPORTE URUGUAY	16	Dario Queirolo	22/10/2021	

N° Exp	Resolución	Denominación	Clases	Titular	Vigencia	Ag.
527960	01/11/2022	MITSUI O.S.K. LINES (mixta)	39 (S/D)	Kabushiki Kaisha Shosen Mitsui (Mitsui O.S.K. Lines, Ltd.)	09/10/2021	192
527961	01/11/2022	IGOR TRACTORS (mixta)	7 y 12 (S/D)	IGOR ALBERTO BUCHTIK	09/02/2022	192
527962	01/11/2022	ALEIS (mixta)	9, 21 y 42	ALLFLEX AUSTRALIA PTY LIMITED	08/08/2021	192
527963	01/11/2022	OCUSEPT	5 (S/D)	DR. GERHARD MANN CHEM.- PHARM. FABRIK GMBH	19/11/2021	192
527964	01/11/2022	THE BRITISH SCHOOLS	16, 18, 25, 28 y 41	THE BRITISH SCHOOLS SOCIETY	12/10/2021	156
527967	01/11/2022	SAFIRO	14 (S/D)	Movado Watch Company S.A.	05/09/2021	94
527977	01/11/2022	DELGACIN	5	Gramón Bagó de Uruguay S.A.	04/09/2021	181
527979	01/11/2022	METAFLX	5	Gramón Bagó de Uruguay S.A.	05/09/2021	181
527980	03/11/2022	BAGOMIDAM	5	Gramón Bagó de Uruguay S.A.	12/09/2021	181
527981	03/11/2022	BAGOVIR	5	Gramón Bagó de Uruguay S.A.	12/09/2021	181
527983	03/11/2022	SCANTRACK	35	Nielsen Consumer LLC	19/09/2021	34
527985	03/11/2022	M (mixta)	25	MAJOR LEAGUE BASEBALL PROPERTIES, INC.	21/11/2021	245
527989	03/11/2022	MATUTINA	29 (S/D), 30 (S/D) y 32 (S/D)	FORT-MASIS S.A.	10/09/2021	245
527993	03/11/2022	BAKO (mixta)	35	Bako S.A.	26/10/2021	101
527997	03/11/2022	CARNICERÍA TRADICIONAL (mixta)	29 y 30	UNION DE VENEDORES DE CARNE	06/12/2021	163
528001	24/11/2022	MACY'S	3, 18, 25, 35, 42 y 43	MACY'S IP HOLDINGS, LLC	06/09/2021	201
528002	03/11/2022	LYNSA	26	FERNANDEZ, MARCELO OMAR	09/10/2021	189
528006	03/11/2022	AXENTRIA (mixta)	42	GARINO HNOS. S.A.	03/10/2021	181
528007	03/11/2022	CIAGEN 600	5 (S/D)	CRAVERI S.A.I.C.	19/11/2021	144
528008	03/11/2022	A.E.T.	5	CRAVERI S.A.I.C.	12/11/2021	144
528009	03/11/2022	DARLING	10 (S/D)	PROPATO HNOS. S.A.I.C.	18/09/2021	144
528010	03/11/2022	RIVOPAX GALIEN	5	Megalabs Uruguay S.A.	09/12/2021	144
528011	03/11/2022	SAAB TECHNOLOGIES (mixta)	9, 12, 13 y 37	SAAB AKTIEBOLAG	21/12/2021	144
528015	03/11/2022	CORRAL DE GUARDIA	5 y 31	BELLAMAR ESTANCIAS S.A.	21/12/2021	219
528016	03/11/2022	CONSUR	37	CONSUR LTDA.	28/11/2021	219

N° Exp	Resolución	Denominación	Clases	Titular	Vigencia	Ag.
528019	03/11/2022	IBERIA	5	INDUSTRIAS IBERIA S.A.	13/09/2021	219
528020	03/11/2022	SYNTEMA	2 (S/D)	SHERWIN-WILLIAMS SWEDEN AB	05/09/2021	201
528021	03/11/2022	POLYTEX	2 (S/D)	SWIMC LLC	30/09/2021	201
528029	03/11/2022	E&V (mixta)	35 (S/D), 36 (S/D) y 41 (S/D)	ENGEL & VÖLKERS MARKEN GMBH & CO. KG	28/11/2021	94
528030	03/11/2022	ENGEL & VÖLKERS	35 (S/D), 36 (S/D) y 41 (S/D)	ENGEL & VÖLKERS MARKEN GMBH & CO. KG	28/11/2021	94
528034	04/11/2022	M MENVEO (mixta)	5 (S/D)	GlaxoSmithKline Biologicals S.A.	25/10/2021	216
528035	04/11/2022	KETEL ONE	33	DOUBLE EAGLE BRANDS B.V.	20/12/2021	216
528036	04/11/2022	NOLET	33	DOUBLE EAGLE BRANDS 1 B.V.	16/12/2021	216
528037	04/11/2022	NOLET'S	33	DOUBLE EAGLE BRANDS 1 B.V.	16/12/2021	216
528038	04/11/2022	ACTIPROTECT	10 (S/D)	GlaxoSmithkline Consumer Healthcare (UK) IP Limited	11/10/2021	216
528039	04/11/2022	VIRUCOAT	5 (S/D)	GLAXO GROUP LIMITED	11/10/2021	216
528040	04/11/2022	BOOSTRIX	5 (S/D)	GLAXOSMITHKLINE BIOLOGICALS S.A.	22/10/2021	216
528050	04/11/2022	ALBO (mixta)	29 (S/D)	HIJOS DE CARLOS ALBO, S.L.	28/10/2021	34
528051	04/11/2022	GRANJA MORO	29	GRANJA TRES ARROYOS URUGUAY S.A.	13/12/2021	34
528054	04/11/2022	CLIMENE	5 (S/D)	Songbook B.V.	20/11/2021	194
528055	04/11/2022	SEMPERIT (mixta)	12 (S/D)	Continental Reifen Austria GmbH	19/11/2021	218
528056	04/11/2022	VUALA	30	CCP Productos S.A.P.I. De C.V.	21/11/2021	245
528058	04/11/2022	RUSTICHELLA D' ABRUZZO LAVORAZIONE ARTIGIANALE (mixta)	29 y 30	RUSTICHELLA D'ABRUZZO S.P.A.	14/09/2021	181
528059	04/11/2022	ECONOMICO OFERTAS (mixta)	35 y 43	MASIVA S.R.L.	21/12/2021	201
528062	04/11/2022	T TRAMONTINA (mixta)	8 y 21	TRAMONTINA S/A CUTELARIA	25/10/2021	245
528063	04/11/2022	MODULARFLEX	27 y 35	PLAMET LTDA	30/09/2021	245
528072	04/11/2022	POP ART URUGUAY	41	PRACALY S.A.	12/09/2021	194
528076	04/11/2022	(figurativa)	42 (S/D)	PETROLEO BRASILEIRO S.A. -	08/09/2021	94

N° Exp	Resolución	Denominación	Clases	Titular	Vigencia	Ag.
				PETROBRAS		
528078	04/11/2022	SEMPERBELLA	3	VARGAS REENGENHARIA INDUSTRIALIZAÇÃO COMERCIALIZAÇÃO LTDA.	22/10/2021	34
528079	04/11/2022	SAVEIRO	12	VOLKSWAGEN AKTIENGESELLSCHAFT	25/10/2021	34
528080	04/11/2022	BENVIC	1 (S/D)	BENVIC SAS	10/01/2022	144
528081	04/11/2022	HYPERREAL	9 (S/D)	SAMSUNG ELECTRONICS CO., LTD.	01/03/2022	144
528082	04/11/2022	BIO KUR (mixta)	3	SADECO S.A.	25/10/2021	34
528086	04/11/2022	SHURE	9	Shure Incorporated	09/01/2022	194
528088	04/11/2022	BANCO SANTANDER	16 (S/D), 35 (S/D) y 38 (S/D)	SANTANDER INVESTMENT BANK LIMITED	26/10/2021	194
528100	04/11/2022	PACIFIC	29 (S/D)	SOLDO HNOS. S.A.	12/11/2021	245
528101	04/11/2022	LIDER (mixta)	16 (S/D)	SOLDO HNOS. S.A.	21/10/2021	245
528102	04/11/2022	EL ALMA (mixta)	18, 25 y 41	VERÓNICA KÖNCKE COLOMINAS	18/10/2021	245
528103	24/11/2022	SAGUAYMIC MICROSULES	5	LABORATORIOS MICROSULES URUGUAY S.A.	05/09/2021	
528105	07/11/2022	MEMORIAS SAXE	3	DISTRIFAR S.R.L.	13/09/2021	201
528106	07/11/2022	VITMIC	5	LABORATORIOS MICROSULES URUGUAY S.A.	15/09/2021	
528107	07/11/2022	NESCAFE (mixta)	9 (S/D) y 38 (S/D)	SOCIETE DES PRODUITS NESTLE S.A.	31/10/2021	34
528109	07/11/2022	BIC DIAMANTE GRIP	16 (S/D)	BIC URUGUAY S.A.	21/11/2021	212
528111	07/11/2022	BIC SHIMMERS	16 (S/D)	BIC URUGUAY S.A.	21/11/2021	212
528112	07/11/2022	KUMTEL (mixta)	11	KUMTEL DAYANIKLI TÜKETİM MALLARI PLASTIK SANAYI VE TICARET ANONİM SİRKETİ	23/03/2021	192
528113	07/11/2022	DIM	2 (S/D), 3 (S/D), 6 (S/D), 7 (S/D), 8 (S/D), 18 (S/D), 20 (S/D), 21 (S/D), 22	Hanes France SAS	26/11/2021	136

N° Exp	Resolución	Denominación	Clases	Titular	Vigencia	Ag.
			(S/D), 23 (S/D), 24 (S/D), 25 y 26 (S/D)			
528114	07/11/2022	LUXELL (mixta)	11	KUMTEL DAYANIKLI TÜKETİM MALLARI PLASTIK SANAYI VE TICARET ANONIM SİRKETİ	23/03/2021	192
528115	07/11/2022	CONTÉ VISAQUARELLE	16 (S/D)	SOCIETE BIC	27/11/2021	212
528120	07/11/2022	TSU	3	MATYBEL SOCIEDAD ANONIMA	26/10/2021	194
528121	07/11/2022	TRACPIPE	6 (S/D)	OMEGA FLEX INC.	23/01/2022	212
528122	07/11/2022	88 EIGHTY EIGHT MILD (mixta)	34	KT & G CORPORATION	26/11/2021	144
528123	07/11/2022	OMEGAFLEX	6 (S/D)	OMEGA FLEX INC.	23/01/2022	212
528124	07/11/2022	NESLAC	29 (S/D)	SOCIETE DES PRODUITS NESTLE S.A.	06/10/2021	34
528125	07/11/2022	DOGUI	31	SOCIÉTÉ DES PRODUITS NESTLÉ S.A.	09/10/2021	34
528126	07/11/2022	BACI	30 (S/D)	SOCIETE DES PRODUITS NESTLE S.A.	14/10/2021	34
528127	07/11/2022	GNP (mixta)	35 y 44	Marcel Marteau Montes y Michel André Marteau Montes	09/09/2021	101
528128	07/11/2022	ON24 (mixta)	3, 35 y 37	Roleril S.A.	09/09/2021	101
528130	07/11/2022	NESCAFE	9 (S/D) y 38 (S/D)	SOCIETE DES PRODUITS NESTLE S.A.	31/10/2021	34
528131	07/11/2022	CORONADO	16 (S/D)	COMPAÑIA INDUSTRIAL DE TABACOS MONTE-PAZ	22/10/2021	245
528132	07/11/2022	KRIKO	30	SOCIETE DES PRODUITS NESTLE S.A.	26/11/2021	34
528133	07/11/2022	RICHMOND FINA SELECCIÓN DE TABACOS DE CALIDAD EXCEPCIONAL (mixta)	34	COMPAÑIA INDUSTRIAL DE TABACOS MONTE-PAZ S.A.	17/11/2021	245
528134	07/11/2022	PUREZA VITAL	32 (S/D)	SOCIETE DES PRODUITS NESTLE S.A.	27/11/2021	34
528135	07/11/2022	SUPERMERCADO ITALIA (mixta)	35 y 43	CARLOS GARCIA	22/09/2021	245

N° Exp	Resolución	Denominación	Clases	Titular	Vigencia	Ag.
528137	07/11/2022	CORONADO LIGHTS (mixta)	34	COMPAÑIA INDUSTRIAL DE TABACOS MONTE-PAZ S.A.	30/11/2021	245
528138	07/11/2022	PACIFIC	34	COMPAÑIA INDUSTRIAL DE TABACOS MONTE-PAZ S.A.	18/11/2021	245
528139	07/11/2022	CORONADO LO AUTENTICO EDICION ESPECIAL SIGLO XXI (mixta)	34	COMPAÑIA INDUSTRIAL DE TABACOS MONTE-PAZ	28/11/2021	245
528140	07/11/2022	NESTLE PURE LIFE	32 (S/D)	SOCIETE DES PRODUITS NESTLE S.A.	28/11/2021	34
528141	07/11/2022	GOLDEN TREE	34	COMPAÑIA INDUSTRIAL DE TABACOS MONTE-PAZ	17/10/2021	245
528142	07/11/2022	CORONADO ULTRA LIGHTS (mixta)	34	COMPAÑIA INDUSTRIAL DE TABACOS MONTE-PAZ S.A.	30/11/2021	245
528143	07/11/2022	PROTECT (mixta)	29 (S/D), 30 (S/D) y 32 (S/D)	SOCIETE DES PRODUITS NESTLE S.A.	29/11/2021	34
528144	07/11/2022	CORONADO LIGHTS (mixta)	34	COMPAÑIA INDUSTRIAL DE TABACOS MONTE-PAZ S.A.	30/11/2021	245
528146	07/11/2022	XXX FILTRO REPUBLICANA (mixta)	34	COMPAÑIA INDUSTRIAL DE TABACOS MONTE-PAZ S.A.	17/11/2021	245
528147	07/11/2022	PIECIDEX	5	GENOMMALAB URUGUAY S.A.	09/10/2021	245
528151	07/11/2022	RITOCOM	5	LABORATORIO LIBRA SOCIEDAD ANONIMA	13/09/2021	129
528153	07/11/2022	TENOF	5	LABORATORIO LIBRA SOCIEDAD ANONIMA	13/09/2021	129
528158	07/11/2022	BIZARRO RECORDS	9 y 41	MARCELO FELDER y ANDRÉS SANABRIA	29/11/2021	94
528162	08/11/2022	TENDENCIAS EN MEDICINA (mixta)	16 y 35	LUIS ALBERTO GONZALEZ MACHADO y GRISELDA MARIA CASTRO PIÑEYRO	09/11/2021	244
528163	07/11/2022	MUXATIL	5 (S/D)	DROGUERIA INTI S.A.	05/09/2021	201
528164	07/11/2022	CARLOS V	30 y 31	COMPAÑIA OLEAGINOSA	14/11/2021	144

N° Exp	Resolución	Denominación	Clases	Titular	Vigencia	Ag.
				URUGUAYA S.A.		
528166	07/11/2022	MAYONISIMA	29 y 30	COMPAÑIA OLEAGINOSA URUGUAYA S.A.	27/11/2021	144
528167	07/11/2022	BUENA VISTA RECORDS (mixta)	9 (S/D)	DISNEY ENTERPRISES, INC.	29/11/2021	144
528168	08/11/2022	HOLLYWOOD RECORDS	9 (S/D)	Disney Enterprises, Inc.	29/11/2021	144
528169	08/11/2022	(figurativa)	36	TEMPLETON GLOBAL ADVISORS LIMITED	06/03/2022	201
528185	08/11/2022	OTTOMANE (mixta)	3	MAGAUD, PATRICK	27/02/2022	189
528190	08/11/2022	(tridimensional)	3 y 5	THE CLOROX INTERNATIONAL COMPANY	12/09/2021	228
528195	08/11/2022	DANLOX	5	LABORATORIOS CASASCO S.A.I.C.	22/11/2021	201
528197	08/11/2022	PALEXIS	5 (S/D)	GRÜNENTHAL GMBH	03/10/2021	201
528198	08/11/2022	ALPHA	25	ALPHA INDUSTRIES, INC.	16/10/2021	201
528199	08/11/2022	MR. PARQUET (mixta)	19 (S/D), 27 y 40	La Buonora, Federico	14/09/2021	194
528200	08/11/2022	LIVE URUGUAY	36	FEDERICA HENDERSON ALGORTA	22/09/2021	179
528201	08/11/2022	DE LAS VERTIENTES	43	WELEDNIGER, ISIDORO	13/09/2021	201
528202	08/11/2022	COLIN´S (mixta)	25	EROGLU GIYIM SANAYI VE TICARET ANONIM SIRKETI	15/11/2021	179
528203	08/11/2022	KRAFT (mixta)	29 (S/D) y 30 (S/D)	KRAFT FOODS GROUP BRANDS LLC	31/05/2021	194
528211	08/11/2022	CIDINE	5	ALMIRALL, S.A.	13/08/2021	194
528212	24/11/2022	KOHINOR	5 (S/D)	ADAMA Celsius B.V. Amsterdam (NL) Schaffhausen Branch	20/09/2021	144
528213	08/11/2022	NIMBIOL	5 (S/D)	POINT AMERICAS S.A.	14/09/2021	129
528217	08/11/2022	PATRIOT	7	WOLMER S.A.	25/09/2021	144
528218	08/11/2022	CHARLES OF THE RITZ (mixta)	3 (S/D)	THE RITZ HOTEL LIMITED	18/09/2021	194
528222	08/11/2022	ENDOFALK	5 (S/D)	Dr. Falk Pharma GmbH	22/10/2021	165
528223	24/11/2022	BOVZUTA	5 (S/D)	WYETH LLC	13/10/2021	194
528224	08/11/2022	LINCOCIN	5 (S/D)	PHARMACIA & UPJOHN COMPANY LLC	25/10/2021	194
528227	08/11/2022	TOTAL EQUILIBRIO	31	NEOVIA NUTRIÇÃO E SAÚDE	12/03/2022	34

N° Exp	Resolución	Denominación	Clases	Titular	Vigencia	Ag.
				ANIMAL LTDA.		
528228	08/11/2022	DRAXXIN	5 (S/D)	Zoetis Services LLC	31/10/2021	194
528229	08/11/2022	MANAGER	25	COAIK COR, RAQUEL DORA	17/09/2021	189
528230	08/11/2022	SPIROVAC	5 (S/D)	Zoetis Services LLC	31/10/2021	194
528231	08/11/2022	SOJASUN (mixta)	29 (S/D)	TRIBALLAT NOYAL	09/10/2021	245
528233	08/11/2022	COLGATE TOTAL PLUS WHITENING (mixta)	3 (S/D)	COLGATE-PALMOLIVE COMPANY	01/10/2021	201
528234	08/11/2022	SENSACIONES SUAVITEL SIN ENJUAGUE NUEVO EDICION ESPECIAL ACONDICIONADOR DE TELAS (mixta)	3 (S/D)	COLGATE-PALMOLIVE COMPANY	03/10/2021	201
528236	08/11/2022	FABULOSO FIESTA EDICION ESPECIAL ¡LIMPIA MÁS Y AROMATIZA POR MÁS TIEMPO! ANTIBACTERIAL (mixta)	3	COLGATE-PALMOLIVE COMPANY	03/10/2021	201
528237	08/11/2022	PALMOLIVE BOTANICALS	3 (S/D)	COLGATE-PALMOLIVE COMPANY	16/10/2021	201
528239	08/11/2022	FABULOSO EFECTO CONTINUO FANTASÍA DE LAVANDA ¡NUEVO! FABULOSO ...AUN CON LAS VENTANAS ABIERTAS! ANTIBACTERIAL (mixta)	3	COLGATE-PALMOLIVE COMPANY	17/10/2021	201
528240	08/11/2022	FIESTA DE FLORES	3 (S/D) y 5 (S/D)	COLGATE-PALMOLIVE COMPANY	22/10/2021	201
528241	08/11/2022	SENSACIONES ACONDICIONADOR DE TELAS SUAVITEL SIN ENJUAGUE NUEVO EDICIÓN ESPECIAL CONT. NET. 850 ML. (mixta)	3 (S/D)	COLGATE-PALMOLIVE COMPANY	03/10/2021	201
528248	08/11/2022	POSTSCRIPT	9	ADOBE INC.	20/11/2021	194
528251	08/11/2022	JOHN PLAYER GOLD LEAF	34	BRITISH AMERICAN TOBACCO (BRANDS) LIMITED	06/12/2021	194
528255	08/11/2022	ARTIGAS (mixta)	34	BATMARK LIMITED	27/11/2021	194

N° Exp	Resolución	Denominación	Clases	Titular	Vigencia	Ag.
528256	08/11/2022	MONTANA FILTERS ALQUITRAN: 16MG NICOTINA: 1.2MG 20 CIGARRILLOS DE CALIDAD (mixta)	34 (S/D)	BATMARK LIMITED	17/10/2021	194
528258	08/11/2022	PALL MALL	34	British American Tobacco (Brands) Inc.	22/10/2021	194
528261	08/11/2022	DEXOS	4 (S/D)	GENERAL MOTORS LLC	25/10/2021	136
528264	08/11/2022	PALL- MALL (mixta)	34 (S/D)	Rothmans of Pall Mall Limited	23/10/2021	194
528266	08/11/2022	NINTENDODSI (mixta)	35 (S/D)	Nintendo of America Inc.	20/09/2021	136
528267	16/11/2022	MAMMOTH RECORDS	9 (S/D)	MAMMOTH RECORDS, INC	29/11/2021	144
528269	24/11/2022	MONTE CARLO TELEVISION (mixta)	16, 25, 35, 38 y 41	MONTE CARLO T.V. S.A.	15/11/2021	144
528270	08/11/2022	LUSIPAX SERVIMEDIC	5	SERVIMEDIC S.A.	14/11/2021	144
528271	08/11/2022	(figurativa)	36 (S/D)	FOUR SEASONS HOTELS (NETHERLANDS) B.V.	31/10/2021	194
528272	08/11/2022	FOUR SEASONS	36 (S/D)	FOUR SEASONS HOTELS (NETHERLANDS) B.V.	31/10/2021	194
528275	09/11/2022	COLORMATIC	9	INDUSTRIA OPTICA RODENSTOCK CHILE S.A.	14/09/2021	34
528276	09/11/2022	COMIENZO SANO VIDA SANA	5 (S/D), 29 (S/D) y 30 (S/D)	SOCIÉTÉ DES PRODUITS NESTLÉ S.A.	30/11/2021	34
528277	09/11/2022	RODEO	30	Société des Produits Nestlé S.A.	06/12/2021	34
528278	09/11/2022	FAGAL	30	Société des Produits Nestlé S.A.	12/12/2021	34
528281	09/11/2022	I2 IDOS (mixta)	35	BAKED PLUS S.A.	26/12/2021	221
528282	09/11/2022	SHIMA SEIKI (mixta)	7, 9 y 37	SHIMA SEIKI MANUFACTURING, LTD.	14/10/2021	245
528286	09/11/2022	HOWARD JOHNSON (mixta)	35 y 43	HOWARD JOHNSON INTERNATIONAL, INC.	19/11/2021	201
528287	16/11/2022	COLUMBIA SPORTSWEAR COMPANY (mixta)	35 (S/D)	COLUMBIA SPORTSWEAR COMPANY	06/03/2022	212
528291	09/11/2022	PARTHENON	16 y 25	CARAVEN SOCIEDAD ANÓNIMA	19/09/2021	189
528296	09/11/2022	LONTREL	5 (S/D)	Dow AgroSciences LLC	01/10/2021	194
528304	09/11/2022	AS DO MAR (mixta)	29 (S/D)	Generale Conserve s.p.a.	03/10/2021	194
528305	09/11/2022	PROSECO (mixta)	35, 37 y 38	PROYECTOS, SERVICIOS Y	04/10/2021	194

N° Exp	Resolución	Denominación	Clases	Titular	Vigencia	Ag.
				COMUNICACIONES S.A.		
528306	09/11/2022	I-DSI (mixta)	12 (S/D)	HONDA GIKEN KOGYO KABUSHIKI KAISHA (TAMBIÉN COMERCIANDO COMO HONDA MOTOR CO., LTD.)	28/11/2021	94
528307	09/11/2022	IMPRESSION FREESIGN	9	INDUSTRIA OPTICA RODENSTOCK CHILE S.A.	15/09/2021	201
528308	09/11/2022	MR DESIGN (mixta)	12	DONIRAL S.A.	05/10/2021	194
528310	09/11/2022	GIANI VERNNET	25	LANCER S.A.	07/10/2021	144
528312	09/11/2022	IBUMIGRA	5	DINEL S.A.	12/11/2021	144
528313	09/11/2022	NEUROACTIL	5	DINEL S.A.	19/11/2021	144
528314	09/11/2022	CARDIOSTAT	5	SERVIMEDIC S.A.	19/11/2021	144
528315	09/11/2022	FLUPAX	5	DINEL S.A.	26/11/2021	144
528317	09/11/2022	AMBEV	32 (S/D) y 35 (S/D)	AMBEV S.A.	22/10/2021	144
528318	24/11/2022	NH (mixta)	43	NH HOTEL GROUP, S.A.	20/12/2021	144
528319	24/11/2022	NHOW	43	NH HOTEL GROUP, S.A.	21/12/2021	144
528320	24/11/2022	NH	16, 39, 41 y 43	NH HOTEL GROUP, S.A.	20/12/2021	144
528321	09/11/2022	SMARTER PLANET	9 (S/D), 16 (S/D) y 42 (S/D)	INTERNATIONAL BUSINESS MACHINES CORPORATION	28/12/2021	144
528325	09/11/2022	PROTTO (mixta)	12	DISTRIBUIDORA COMERSUR S.A.	16/09/2021	245
528326	09/11/2022	VANTOCIL	5 (S/D)	ARCH UK BIOCIDES LIMITED	29/11/2021	205
528328	09/11/2022	PURISTA	5 (S/D)	ARCH UK BIOCIDES LIMITED	27/11/2021	205
528329	09/11/2022	ILARIS	5 (S/D)	NOVARTIS AG	07/03/2022	201
528330	09/11/2022	POETT AIRES NAVIDEÑOS	3 y 5	CLOROX ARGENTINA S.A.	27/09/2021	228
528333	09/11/2022	CEBROTEL	5	BALIARDA S.A.	19/09/2021	201
528334	09/11/2022	CINETEC	5	BALIARDA S.A.	19/09/2021	201
528335	09/11/2022	VALOPRAL	5	BALIARDA S.A.	19/09/2021	201
528336	09/11/2022	ILDUC	5	BALIARDA S.A.	19/09/2021	201
528338	09/11/2022	ANDIAMO!	29 y 30	ALONZO MORENO, ALEX GASTÓN	21/10/2021	189
528350	09/11/2022	MARUCHAN	29	Maruchan, Inc.	12/11/2021	136
528352	09/11/2022	PIENSO (mixta)	35	CASTRO GONZALEZ, PABLO	05/10/2021	194

N° Exp	Resolución	Denominación	Clases	Titular	Vigencia	Ag.
528355	09/11/2022	TRIZIMAN	5 (S/D)	CEREXAGRI B.V.	22/10/2021	144
528356	09/11/2022	PITZER (mixta)	29	VULCANIA S.A.	14/10/2021	144
528360	09/11/2022	BIONUTRI EL PODER DE LO NATURAL (mixta)	30 y 31	LAGOMARSINO BUSTINGORRY, MIRTHA	05/10/2021	194
528361	09/11/2022	VENTUS	12 (S/D)	HANKOOK TIRE CO., LTD.	12/11/2021	194
528364	09/11/2022	POLISTEN	2	RENNER SAYERLACK S.A.	12/10/2021	34
528365	09/11/2022	BERNINA (mixta)	29	FRIGORIFICO TACUAREMBO S.A.	16/09/2021	194
528373	09/11/2022	MCKINSEY	9, 16, 35 y 36	McKinsey Holdings, Inc.	20/09/2021	201
528375	09/11/2022	CAPILATIS	3	CAPILATIS S.A.	21/10/2021	240
528377	09/11/2022	BUN (mixta)	29 y 30	PEPSICO DE ARGENTINA S.R.L.	04/10/2021	201
528378	09/11/2022	BUN	29 y 30	PEPSICO DE ARGENTINA S.R.L.	04/10/2021	201
528379	09/11/2022	20 MULE TEAM BORAX (mixta)	1	U.S. BORAX INC.	13/10/2021	201
528380	09/11/2022	BORAX (mixta)	1, 2 y 5 (S/D)	U.S. BORAX INC.	26/10/2021	201
528382	10/11/2022	AMANA	11 (S/D)	Maytag Worldwide N.V.	18/09/2021	136
528386	10/11/2022	MW MAGMAWELD (mixta)	6 (S/D), 7 (S/D) y 9 (S/D)	ZAIMOGLU HOLDING A.S	16/11/2021	192
528387	10/11/2022	ARQUI P.O.P.	16, 20, 35 y 37	ARQUIFOAM S.A.	07/03/2022	189
528388	10/11/2022	FUCOL	1 (S/D)	LUIS GUSTAVO FERRARI FALOTICO	18/09/2021	129
528389	10/11/2022	EVOLUTION (mixta)	9 (S/D) y 10 (S/D)	SENNHEISER ELECTRONIC GMBH & CO. KG	22/10/2021	201
528390	10/11/2022	CONFITERÍA LA NUEVA BARCELONESA (mixta)	35 (S/D)	VISAO SA	29/11/2021	
528392	10/11/2022	S1	12 (S/D)	AUDI AG	05/12/2021	201
528393	24/11/2022	WX WILEY X (mixta)	9 (S/D) y 25 (S/D)	Wiley X, Inc.	03/10/2021	216
528394	10/11/2022	VALVOLINE	4 (S/D)	ASHLAND LICENSING AND INTELLECTUAL PROPERTY LLC	12/06/2021	216
528395	10/11/2022	MASTERCARD (mixta)	9 (S/D), 16, 35, 36 (S/D), 38, 39, 42, 43, 44 y 45	MASTERCARD INTERNATIONAL INCORPORATED	22/06/2021	216
528396	10/11/2022	CLARKS.STREET: ESTABLISHED	25	C. & J. CLARK INTERNATIONAL	28/11/2021	216

N° Exp	Resolución	Denominación	Clases	Titular	Vigencia	Ag.
		1825: (mixta)		LIMITED		
528397	10/11/2022	ENASAVE	12 (S/D)	SUMITOMO RUBBER INDUSTRIES, LTD.	03/10/2021	216
528398	10/11/2022	EQUIMAX	5	VIRBAC S.A.	22/10/2021	216
528399	10/11/2022	CEBION	1 (S/D) y 5 (S/D)	P&G Health Germany GmbH	18/09/2021	216
528400	10/11/2022	GRANINI	32 (S/D)	Eckes-Granini Group GmbH	18/09/2021	136
528407	10/11/2022	FRESH TOPPINGS (mixta)	30 (S/D)	Sugar Foods Corporation	05/10/2021	194
528408	10/11/2022	CHUCKER ... PARA ENDULZAR LO IMAGINABLE	1	MERISANT COMPANY 2 SARL	25/10/2021	194
528411	10/11/2022	PAINS JACQUET (mixta)	30 (S/D)	JACQUET BROSSARD	16/10/2021	144
528412	24/11/2022	ENJOY (mixta)	35, 41 y 43	BRAUSE, CAROLINA	11/10/2021	194
528413	10/11/2022	XTRALIFE	9	EASTMAN KODAK COMPANY	19/11/2021	144
528414	10/11/2022	AVANTI	30 (S/D)	LABREZZA S.A.	26/11/2021	144
528417	10/11/2022	GLUMINA	5	PHARMOS S.A.	21/11/2021	144
528418	10/11/2022	BAMBINA	29, 30 y 31	SILCOM S.A.	14/11/2021	144
528419	10/11/2022	CLUB NOSOTRAS	35 y 38	PRODUCTOS FAMILIA S.A.	15/11/2021	144
528420	10/11/2022	NOSOTRASONLINE	35 y 38	PRODUCTOS FAMILIA S.A.	15/11/2021	144
528421	10/11/2022	ECONOPACK	5 (S/D)	PRODUCTOS FAMILIA S.A.	28/11/2021	144
528422	10/11/2022	INVISIBLE	16	PRODUCTOS FAMILIA S.A.	29/11/2021	144
528423	10/11/2022	GALLIPRO	5 (S/D) y 31 (S/D)	Chr. Hansen A/S	07/10/2021	194
528424	10/11/2022	CARELLO (mixta)	11 (S/D)	AUTOMOTIVE LIGHTING ITALIA S.P.A.	25/10/2021	212
528429	16/11/2022	SF SAXON LIGHTS (mixta)	34	LA REPUBLICANA S.A.	25/09/2021	245
528435	10/11/2022	OVALMATIC	7 (S/D)	Enterprises International, Inc.	20/09/2021	228
528443	11/11/2022	FOXPRINT INSUMOS DE IMPRESIÓN (mixta)	2 y 35	ALVARO CARRIL	25/07/2021	212
528447	16/11/2022	OMNI-HEAT	18 (S/D), 20 (S/D), 21 (S/D), 22 (S/D) y 25	COLUMBIA SPORTSWEAR COMPANY	19/03/2022	212
528448	10/11/2022	NOVARBO	1 (S/D) y 11 (S/D)	NOVARBO OY	05/12/2021	144

N° Exp	Resolución	Denominación	Clases	Titular	Vigencia	Ag.
528454	10/11/2022	ZESPRI (mixta)	29, 30, 31 y 32	ZESPRI GROUP LIMITED	12/11/2021	181
528457	10/11/2022	PILARICA	32 (S/D) y 33 (S/D)	A. LOPEZ & CIA. S.A.	18/09/2021	201
528460	10/11/2022	TRIVENTO	33	TRIVENTO BODEGAS Y VIÑEDOS S.A.	04/10/2021	218
528471	24/11/2022	ABORDO	16	GRASIUSO, GABRIEL	21/09/2021	189
528498	10/11/2022	SAN REMO (mixta)	29 (S/D)	Clearlight Investments Pty Ltd	15/11/2021	136
528499	10/11/2022	SAN REMO (mixta)	30 (S/D)	Clearlight Investments Pty Ltd	15/11/2021	136
528500	10/11/2022	BOTULAX	5	LABORATORIO LIBRA SOCIEDAD ANONIMA	21/09/2021	129
528506	11/11/2022	FESTTA (mixta)	25	Hector Tagliabue	25/10/2021	
528508	11/11/2022	LEVI'S	18 (S/D) y 25 (S/D)	LEVI STRAUSS & CO.	09/10/2021	194
528509	11/11/2022	ASTROTOURBILLON	14 (S/D)	CARTIER INTERNATIONAL AG	19/03/2022	144
528511	11/11/2022	SILVERTAB	18 (S/D)	LEVI STRAUSS & CO.	09/10/2021	194
528513	11/11/2022	ACQUA DI GIO'	3	GIORGIO ARMANI S.P.A.	04/10/2021	34
528516	11/11/2022	SHIMGE (mixta)	7	Shimge Pump Industry (ZheJiang) Co., Ltd	23/01/2022	245
528517	11/11/2022	NEWFITNESS (mixta)	35	MAURO RADZINSKI	09/12/2021	245
528518	11/11/2022	ARMANI	3, 9, 14, 16, 18, 25 y 35	GIORGIO ARMANI S.P.A.	04/10/2021	34
528519	11/11/2022	ACNIELSEN	9, 16, 35 y 42	THE NIELSEN COMPANY (US), LLC	12/10/2021	34
528522	11/11/2022	ACTOVEGIN	5 (S/D)	TAKEDA AUSTRIA GmbH	28/10/2021	34
528523	11/11/2022	BURMA	40	PEMBROKE PARK CORPORATION	28/10/2021	201
528524	11/11/2022	COTTONELLE	3 (S/D)	KIMBERLY-CLARK WORLDWIDE, INC.	26/10/2021	34
528525	11/11/2022	KIMBERLY-CLARK	3 (S/D)	KIMBERLY-CLARK WORLDWIDE, INC.	19/10/2021	34
528526	11/11/2022	KOTEX SECURITY	5 (S/D)	KIMBERLY-CLARK WORLDWIDE, INC.	12/10/2021	34
528527	11/11/2022	MULTIFIT	10	BECTON DICKINSON AND COMPANY	10/10/2021	34

N° Exp	Resolución	Denominación	Clases	Titular	Vigencia	Ag.
528529	11/11/2022	FRAPPUCCINO	32	STARBUCKS CORPORATION	29/11/2021	212
528531	11/11/2022	SC JOHNSON A FAMILY COMPANY	3 (S/D), 4 (S/D), 5 (S/D), 16 (S/D) y 21 (S/D)	S.C. JOHNSON & SON, INC.	08/03/2022	34
528534	24/11/2022	CHIQUITITAS RINCÓN DE LUZ	9, 16, 38 y 41	TELEVISIÓN FEDERAL S.A. - TELEFÉ	09/10/2021	194
528545	11/11/2022	GLOBALNET	38	NIPOWORLD S.A.	19/10/2021	219
528546	11/11/2022	KOSITAS SNACKS EL TRIGAL (mixta)	30 (S/D)	EL TRIGAL S.A.	28/11/2021	165
528547	11/11/2022	CANDY CHIPS (mixta)	29 y 30	EL TRIGAL S.A.	28/11/2021	165
528549	11/11/2022	TAKE EL TRIGAL (mixta)	30	EL TRIGAL S.A.	20/11/2021	165
528550	11/11/2022	AQUARIUS (mixta)	32	THE COCA-COLA COMPANY	18/11/2021	94
528551	11/11/2022	(figurativa)	32	THE COCA-COLA COMPANY	21/11/2021	94
528552	11/11/2022	UVITA DE PLATA (mixta)	33	RPB S.A.	22/02/2022	192
528553	11/11/2022	DELAVAL	1 (S/D), 3 (S/D), 4 (S/D), 5 (S/D), 6 (S/D), 7 (S/D), 8 (S/D), 9 (S/D), 11 (S/D), 12 (S/D), 17 (S/D), 18 (S/D), 21 (S/D), 25 (S/D), 27 (S/D), 31 (S/D), 36 (S/D), 37 (S/D), 41 (S/D) y 44 (S/D)	DELAVAL HOLDING AB	28/11/2021	144
528554	11/11/2022	HYUNDAI (mixta)	6 (S/D) y 7 (S/D)	HYUNDAI HEAVY INDUSTRIES HOLDINGS CO., LTD.	09/03/2022	144
528556	11/11/2022	ST. RAPHAEL	33 (S/D)	ST RAPHAËL SAS	19/12/2021	144
528557	11/11/2022	URUMATI	30	S.A. MOLINOS ARROCEROS NACIONALES	20/11/2021	192
528559	11/11/2022	THALES	9 (S/D)	THALES	09/10/2021	194
528560	11/11/2022	VESTOLEN	1 (S/D) y 17 (S/D)	SABIC PETROCHEMICALS B.V.	14/11/2021	192
528561	11/11/2022	ZERO	3	QUIMICA S.A.	12/11/2021	192

N° Exp	Resolución	Denominación	Clases	Titular	Vigencia	Ag.
528564	11/11/2022	YOLY	29	GIBUR S.A.	25/10/2021	245
528565	11/11/2022	TIGER BALM	5 (S/D)	HAW PAR CORPORATION LIMITED	18/04/2021	192
528568	11/11/2022	(figurativa)	3 (S/D)	KENZO	18/11/2021	245
528570	11/11/2022	CLARINS	3 (S/D)	CLARINS	22/10/2021	245
528583	11/11/2022	MONT BLANC (mixta)	3 (S/D)	Montblanc-Simplo GmbH	09/10/2021	194
528584	11/11/2022	BRALMAX	5	LABORATORIO GADOR S.A.	14/11/2021	165
528585	11/11/2022	BELBARMICINA	5	LABORATORIO GADOR S.A.	18/11/2021	165
528586	11/11/2022	ANTIESPAS	5 (S/D)	LABORATORIO GADOR S.A.	19/11/2021	165
528587	11/11/2022	DRIMUX	5	LABORATORIO GADOR S.A.	19/11/2021	165
528588	11/11/2022	DIABEXAN	5	LABORATORIO GADOR S.A.	19/11/2021	165
528589	11/11/2022	CYTOVIR	5	LABORATORIO GADOR S.A.	21/11/2021	165
528590	11/11/2022	DORACIL	5	LABORATORIO GADOR S.A.	21/11/2021	165
528591	11/11/2022	BIOSOMAT	5	LABORATORIO GADOR S.A.	26/11/2021	165
528598	14/11/2022	EUROTAK	16	TORRASPAPEL, S.A.	19/10/2021	144
528608	14/11/2022	ERPA	16 (S/D)	ERPA S.A.	18/10/2021	201
528610	14/11/2022	GALVUS	5 (S/D)	NOVARTIS AG	04/01/2022	201
528613	14/11/2022	ZIPLOC R (mixta)	16 (S/D) y 21 (S/D)	S. C. JOHNSON & SON, INC.	04/03/2022	34
528614	14/11/2022	SC JOHNSON A FAMILY COMPANY (mixta)	3 (S/D), 4 (S/D), 5 (S/D), 16 (S/D) y 21 (S/D)	S. C. JOHNSON & SON, INC.	08/03/2022	34
528617	14/11/2022	RICETEC (mixta)	31	RiceTec, Inc.	04/10/2021	34
528618	14/11/2022	MONKEYS (mixta)	43	LEGAMAR S.A.	30/11/2021	201
528620	14/11/2022	ANSELL	10	ANSELL LIMITED	20/11/2021	216
528633	14/11/2022	TAIKONAUT	14 (S/D)	MONTRES TUDOR S.A.	26/10/2021	144
528644	14/11/2022	COMPAÑIA DE INDIAS (mixta)	35	COMPAÑIA DE INDIAS LTDA.	16/10/2021	201
528645	14/11/2022	KAPLAN	35 y 36	ALFREDO BENNO KAPLAN KATZ	18/10/2021	34
528647	14/11/2022	TOTVS	42	TOTVS S.A.	14/03/2022	34
528653	14/11/2022	RBC INSURANCE	36 (S/D)	ROYAL BANK OF CANADA	20/12/2021	201
528655	14/11/2022	XOXO	3, 9 y 18	GLOBAL BRAND HOLDING, LLC (GLOBAL)	16/10/2021	245

N° Exp	Resolución	Denominación	Clases	Titular	Vigencia	Ag.
528656	14/11/2022	POCITOS PLAZA HOTEL	43 (S/D)	TELBEC S.A.	19/11/2021	245
528661	14/11/2022	FOX	25	FOX HEAD, INC.	04/10/2021	194
528662	14/11/2022	TRYP HOTELES (mixta)	43 (S/D)	TRYP HOTELS WORLDWIDE, INC.	14/12/2021	245
528664	14/11/2022	RIOGAS EL CALOR DE UN PUEBLO (mixta)	4, 6, 11, 37, 39 y 40	RIOGAS SOCIEDAD ANONIMA	18/11/2021	
528665	14/11/2022	GG (mixta)	5 (S/D) y 10 (S/D)	GRIFOLS, S.A.	22/10/2021	194
528666	14/11/2022	PROLASTIN	5 (S/D)	GRIFOLS THERAPEUTICS LLC	30/11/2021	194
528670	14/11/2022	MEIJI (mixta)	5 (S/D)	MEIJI HOLDINGS CO., LTD.	11/10/2021	194
528676	14/11/2022	ROSA BLANCA	30	RICOTONA S.A.	26/09/2021	118
528677	14/11/2022	(figurativa)	31	SYNGENTA PARTICIPATIONS AG	18/10/2021	194
528679	14/11/2022	ADMIRALS CLUB (mixta)	39	American Airlines, Inc.	20/11/2021	136
528680	14/11/2022	JIMMY NEUTRON EL NIÑO GENIO	41 (S/D)	VIACOM INTERNATIONAL INC.	19/10/2021	194
528681	15/11/2022	AMERICAN AIRLINES (mixta)	39	American Airlines, Inc.	20/11/2021	136
528693	14/11/2022	O&M	35 (S/D)	WPP Properties	29/09/2021	194
528695	14/11/2022	TSAR	3 (S/D)	VAN CLEEF & ARPELS SA	22/10/2021	194
528703	14/11/2022	ILUSIÓN	25	DILTEX S.A. DE C.V.	21/11/2021	186
528707	14/11/2022	CLAROGRAF	1 (S/D) y 5	JUSTE, S.A. QUIMICO-FARMACEUTICA	24/03/2022	34
528720	14/11/2022	GREMAR (mixta)	29	MIRASCO URUGUAY S.A.	20/11/2021	201
528724	14/11/2022	SOUTHBEACH (mixta)	25	CATTO'S S.R.L.	29/09/2021	129
528730	14/11/2022	LA VASQUITA DEL PRADO (mixta)	1, 29, 30, 31 y 33	Susana Noya	22/02/2022	
528731	14/11/2022	PATERTEST (mixta)	5 y 10	NOBELOY S.A.	29/09/2021	94
528734	14/11/2022	LECSAM	29 (S/D)	BUNGE ALIMENTOS S.A.	20/11/2021	245
528735	14/11/2022	FORWARD FHS HIGH SCHOOL (mixta)	41 (S/D)	DORA INÉS, GUERRA ALVAREZ	29/09/2021	194
528742	14/11/2022	AZOR	16 (S/D)	NOZALA S.A. DE C.V.	29/11/2021	156
528744	14/11/2022	KINERA	16 (S/D)	NOZALA S.A. DE C.V.	29/11/2021	156
528752	14/11/2022	PERRY ELLIS	3 (S/D)	PERRY ELLIS INTERNATIONAL GROUP HOLDINGS LIMITED	18/10/2021	194
528756	14/11/2022	PARADA 30 BRAVA - PUNTA DEL	43	GERMAN IRIARTE y JOSE MARIA	29/03/2021	245

N° Exp	Resolución	Denominación	Clases	Titular	Vigencia	Ag.
		ESTE (mixta)		ZUBILLAGA		
528757	16/11/2022	DON VITTORIO (mixta)	30	ALICORP SOCIEDAD ANONIMA ABIERTA (ALICORP S.A.A.)	26/10/2021	212
528760	14/11/2022	THEORY	25 y 35	Theory LLC	11/10/2021	136
528761	14/11/2022	HERING STORE (mixta)	25	CIA. HERING	01/10/2021	212
528763	14/11/2022	TIGERMARKET (mixta)	35 (S/D)	Exxon Mobil Corporation	19/11/2021	136
528765	14/11/2022	MONTEVIDEO WANDERERS FUTBOL CLUB (mixta)	16, 25 y 28	MONTEVIDEO WANDERERS FUTBOL CLUB	29/03/2021	192
528767	15/11/2022	TIGERMARKET (mixta)	35 (S/D)	Exxon Mobil Corporation	26/11/2021	136
528772	15/11/2022	ZORZAL	33	ESTABLECIMIENTO JUANICO S.A.	06/10/2021	201
528773	15/11/2022	MENZEL GLASER (mixta)	9 (S/D) y 10 (S/D)	GERHARD MENZEL GmbH	25/03/2022	192
528774	15/11/2022	(figurativa)	16, 29, 30, 31, 35, 36, 39, 42, 43, 44 y 45	HENDERSON & CIA. S.A.	01/10/2021	181
528775	15/11/2022	JACK LINK`S	29 (S/D)	LINK SNACKS, INC	13/12/2021	184
528776	16/11/2022	JACK LINK'S (mixta)	29 (S/D)	LINK SNACKS, INC	13/12/2021	184
528777	15/11/2022	BORK (mixta)	35 (S/D)	PEDRO BRAGARD	17/10/2021	186
528784	15/11/2022	INDEPENDENT GROUP	39	Independent Ship Agents S.A.	14/03/2022	94
528790	15/11/2022	ETTI	29 (S/D), 30 (S/D) y 32 (S/D)	STELLA D'ORO ALIMENTOS LTDA.	26/03/2022	34
528792	15/11/2022	RYDAPT	5 (S/D)	NOVARTIS AG	05/01/2022	201
528793	15/11/2022	EXJADE	5 (S/D)	NOVARTIS AG	08/03/2022	201
528794	15/11/2022	E ERICSSON (mixta)	9 (S/D), 11 (S/D), 16 (S/D), 35 (S/D), 36 (S/D), 37 (S/D), 38 (S/D), 41 (S/D), 42 (S/D) y 45 (S/D)	TELEFONAKTIEBOLAGET L M ERICSSON	13/03/2022	144
528795	15/11/2022	LINA	5 y 16	KIMBERLY-CLARK ARGENTINA S.A.	25/10/2021	34
528796	15/11/2022	STANLEY (mixta)	8 (S/D)	STANLEY BLACK & DECKER INC.	18/09/2021	216
528797	15/11/2022	DUFOUR	9 y 14	VAZQUEZ NANINI, PABLO EDUARDO	22/10/2021	201

N° Exp	Resolución	Denominación	Clases	Titular	Vigencia	Ag.
528798	15/11/2022	MID	1, 30 y 32 (S/D)	AJINOMOTO CO., INC.	06/09/2021	216
528800	15/11/2022	MAREZIA	25	MAREZIA COMERCIO E REPRESENTACOES DE ARTIGOS ESPORTIVOS LTDA.	22/10/2021	34
528801	15/11/2022	I.LINK	9 (S/D)	SONY CORPORATION	16/10/2021	201
528802	15/11/2022	PANAVISION	16 (S/D)	PANAVISION INTERNATIONAL, L.P.	03/12/2021	216
528803	15/11/2022	DESCONGESTIL	5 (S/D)	URUFARMA S.A.	07/03/2022	34
528804	15/11/2022	HOYA (mixta)	9 (S/D)	HOYA CORPORATION	09/11/2021	216
528805	15/11/2022	THE ESSENCE OF UMAMI AJI-NO-MOTO UMAMI SEASONING (mixta)	30 (S/D)	AJINOMOTO CO., INC.	25/11/2021	216
528807	15/11/2022	NICHIYU (mixta)	7 (S/D), 12 (S/D) y 37 (S/D)	MITSUBISHI LOGISNEXT CO., LTD.	21/11/2021	216
528809	15/11/2022	MOVIMIENTO CARTOON	35	THE CARTOON NETWORK, INC.	12/10/2021	216
528811	15/11/2022	SYM-BIONIC TITAN	9 y 41	THE CARTOON NETWORK, INC.	17/10/2021	216
528819	15/11/2022	D (mixta)	18 (S/D), 25 (S/D) y 28 (S/D)	GLOBERIDE, Inc.	26/12/2021	136
528820	15/11/2022	DAIWA (mixta)	18 (S/D), 25 (S/D) y 28 (S/D)	GLOBERIDE, Inc.	29/03/2022	136
528821	15/11/2022	CASTILLO ENCANTADO (mixta)	41	julio persechini	22/10/2021	
528828	15/11/2022	TP WHITE	16 (S/D)	SUZANO S.A.	02/12/2021	34
528838	15/11/2022	YOKI (mixta)	29 (S/D), 30 (S/D) y 31 (S/D)	GENERAL MILLS BRASIL ALIMENTOS LTDA.	28/10/2021	144
528839	15/11/2022	HERING STORE (mixta)	25	CIA. HERING	01/10/2021	212
528848	15/11/2022	CAMPER (mixta)	25 (S/D)	CAMPER, S.L.	22/10/2021	34
528850	15/11/2022	(figurativa)	7 (S/D) y 37 (S/D)	OTIS ELEVATOR COMPANY	09/10/2021	34
528851	15/11/2022	GOLITE	18, 20, 22 y 25	GoLite Brands LLC	08/06/2021	216
528853	15/11/2022	TEMANA	3, 5 y 30	TEMANA URUGUAY S.A.	25/10/2021	34

RESOLUCIONES DE RENOVACIONES DE FRASES PUBLICITARIAS, CONCEDIDAS

N° Exp	Resolución	Denominación	Clases	Titular	Vigencia	Ag.
479109	06/10/2022	RISPERIN	5 (S/D)	LABORATORIO GADOR S.A.	20/11/2016	165
486799	03/10/2022	HACE CUANTO NO CAMBIAS EL COLCHON	20	DIVINO S.A.	17/09/2017	201
496570	06/10/2022	JEEP	7 (S/D) y 11 (S/D)	JAMES S.A.	06/09/2018	228
499295	06/10/2022	MAJIREL	3 (S/D)	L' OREAL	08/12/2018	144
520182	03/10/2022	TU SHOPPING, CADA VEZ MÁS CERCA (mixta)	35, 36, 38, 39, 41, 42, 43, 44 y 45	SHOPPING CENTERS (URUGUAY) S.A.	30/05/2021	34
522733	28/10/2022	UN MUNDO APARTE	42, 43, 44 y 45	HOTEL NIRVANA S.A.	16/07/2021	179
523298	17/11/2022	LA RENOVACION ESTA EN EL CAMBIO	2 y 27	RAMALUX SOCIEDAD ANONIMA	11/05/2021	239
525690	13/10/2022	SEGUI LA LINEA DE TU FRESCURA	30	ARCOR S.A.I.C.	28/06/2021	154
526076	28/10/2022	URUGUAY EL PAIS DEL TANNAT	33	INSTITUTO NACIONAL DE VITIVINICULTURA (INAVI)	09/07/2021	219

TRANSFERENCIAS

N° Exp.	Resolución	Denominación	Clases	Titular	Dirección	Ag.
381451	18/10/2022	VENOTENSIN	5	QUIMICA ARISTON URUGUAY S.A.	LA PAZ 2257, MONTEVIDEO, URUGUAY	165
391098	24/10/2022	ZONATECNO WWW.ZONATECNO.COM.UY	35	GONZALO MACEDO ZAS	Juncal 1401, MONTEVIDEO, URUGUAY	94
391458	25/10/2022	XANAPIE	3 y 5	QUIMICA SILEX (URUGUAY) S.A.	Francisco Vidal 677/301, Montevideo, URUGUAY	129
393744	07/11/2022	SANTA MARIA	32 y 33	MIRTA STELLA GILOMEN BROCARD	Camino San Fuentes 3225, MONTEVIDEO, URUGUAY	
394191	04/11/2022	SIXTYSEVEN	18, 25 y 35	PASCUAL ROS AGUILAR	CALLE SEVERO OCHOA N° 36, ELCHE, ALICANTE, ESPAÑA; CALLE SEVERO OCHOA N° 36, 03203, ELCHE,	34

N° Exp.	Resolución	Denominación	Clases	Titular	Dirección	Ag.
					ALICANTE, ESPAÑA; CALLE SEVERO OCHOA N° 36, ELCHE, ALICANTE, ESPAÑA y CALLE SEVERO OCHOA N° 36, 03203, ELCHE, ALICANTE, ESPAÑA	
394392	25/10/2022	ALTAMA	25	ALTAMA DELTA CORPORATION	5968 Commerce Blvd., 37814, Morristown., TN, E. U. DE NORTEAMERICA	136
394392	03/11/2022	ALTAMA	25	The Original Footwear Company, Inc.	5968 Commerce Blvd., 37814, Morristown., TN, E. U. DE NORTEAMERICA	136
397128	18/11/2022	METEOR	3	LORIS AZZARO B.V.	2, rue du Pont-Neuf, 75001, Paris, FRANCIA	18
397841	12/10/2022	TROPICAL	32	PRODUCTORA LA FLORIDA, S. A.	Echeverría, en las instalaciones de la Cervecería Costa Rica, Alajuela, Rio Segundo, COSTA RICA	29
399012	22/11/2022	SAPOLIO	3	INTRADEVCO INDUSTRIAL S.A. y VAN CAMPEN INTERNATIONAL CORPORATION	AV. Produccion Nacional N°188, Chorrillos, Lima, PERU	205
404334	25/10/2022	LA DOMÉNICA	35 y 43	Amalia Bibiana Paradiso Manente	Libertad 2919, montevid, URUGUAY y GESTIDO 2490, MONTEVIDEO, URUGUAY	
405041	18/11/2022	ANNITA	5	PHARMA DEVELOPMENT SA	José Enrique Rodo 6424, CIUDAD AUTONOMA DE BUENOS AIRES, ARGENTINA	212
405842	11/11/2022	MONEY BURST	9	WMS GAMING INC.	6601 Bermuda Road, 89119, Las Vegas, Nevada, E. U. DE NORTEAMERICA	144
405844	11/11/2022	HOT HOT SUPER RESPIN	9	WMS GAMING INC.	6601 Bermuda Road, 89119, Las Vegas, Nevada, E. U. DE	144

N° Exp.	Resolución	Denominación	Clases	Titular	Dirección	Ag.
					NORTEAMERICA	
405857	24/10/2022		32	ATLANTIC INDUSTRIES	Southgate Dublin Road, A92YK7W, DROGHEDA, IRLANDA	94
406295	11/10/2022	COMPINCHE	5	BRILLOLUZ S.A.	JOSE PEDRO VARELA 4167, MONTEVIDEO, MONTEVIDEO, URUGUAY	13
406457	08/11/2022	SUN SPARK	3	HFC Prestige International Holding Switzerland Sàrl	chemin Louis-Hubert 1, 1213, Petit -Lancy, SUIZA	201
407287	08/11/2022	SIGNIFOR	5	NOVARTIS AG	LINDENSTRASSE 8, ., CH-6340, BAAR, BAAR, SUIZA	201
407921	24/10/2022	ZONATECNO	35	GONZALO MACEDO	JUNCAL 1401, MONTEVIDEO, URUGUAY	94
408157	07/11/2022	ITZAL	5	THE LATIN AMERICA TRADEMARK CORPORATION	Ruta 101 Km. 23.500 Parque de las Ciencias, Edificio Mega Pharma, Piso 3, Colonia Nicolich, Canelones, URUGUAY	144
408493	20/10/2022	EUROKOTE	16	SARRIOPAPEL Y CELULOSA S.A.	C/Llull, 331, BARCELONA, ESPAÑA	94
410152	11/11/2022	SAPOLIO	5 y 21	INTRADEVCO INDUSTRIAL S.A. y VAN CAMPEN INTERNATIONAL CORPORATION	Av. Produccion Nacional N° 188, Chorrillos, Lima , PERU	212
410724	30/09/2022	CEGELEC	7, 9, 11 y 12	VINCI ENERGIES (société anonyme)	280, rue du 8 mai 1945, 78360, Montesson, FRANCIA	219
411378	21/11/2022	GNV	37	SAKTAL S.A.	Juncal 1392, Montevideo, URUGUAY	180
411695	18/10/2022	THE WEATHER CHANNEL EL CANAL DEL TIEMPO	9, 38, 41 y 42	THE WEATHER CHANNEL, INC.	300 Interstate North Parkway, ATLANTA, Georgia, E. U. DE NORTEAMERICA	20
411695	25/10/2022	THE WEATHER CHANNEL	9, 38, 41 y 42	WEATHER GROUP	300 Interstate North Parkway,	20

N° Exp.	Resolución	Denominación	Clases	Titular	Dirección	Ag.
		EL CANAL DEL TIEMPO		TELEVISION, LLC.	ATLANTA, Georgia, E. U. DE NORTEAMERICA	
411938	22/11/2022	CAÑA DE LOS 33 ORIENTALES	33	ADMINISTRACION NACIONAL DE COMBUSTIBLES ALCOHOL Y PORTLAND	Arenal Grande 2284, MONTEVIDEO, URUGUAY	201
412653	07/11/2022	NY & CO NEW YORK & COMPANY	3, 25 y 35	LERNCO, INC.	275 Madison Avenue, 3rd. Floor, 10016, NEW YORK, NEW YORK, E. U. DE NORTEAMERICA	194
412824	17/10/2022	SMOOTHATION	3	HFC Prestige International Operations Switzerland Sàrl	chemin Louis-Hubert 1-3, 1213, Petit -Lancy, SUIZA	201
412824	14/10/2022	SMOOTHATION	3	HFC Prestige International Holding Switzerland Sàrl	chemin Louis-Hubert 1-3, 1213, Petit -Lancy, SUIZA	201
414624	12/10/2022	TARJETA VERDE	35 y 36	FINAMERICATI S.R.L.	RIO NEGRO 1354 OFICINA 20, MONTEVIDEO, URUGUAY	
415055	18/11/2022	PEOPLE'S SHOES OF ITALY	25	SUPERGA TRADEMARK S.R.L.	LARGO MAURIZIO VITALE 1, 10152, TURIN, ITALIA	212
415055	21/11/2022	PEOPLE'S SHOES OF ITALY	25	BASIC PROPERTIES S.R.L.	LARGO MAURIZIO VITALE 1, 10152, TURIN, ITALIA	212
415056	15/11/2022	SUPERGA	9, 18 y 25	SUPERGA TRADEMARK S.R.L.	Largo Maurizio Vitale 1, 10152, Turin, ITALIA	212
415056	18/11/2022	SUPERGA	9, 18 y 25	BASIC PROPERTIES S.R.L.	Largo Maurizio Vitale 1, 10152, Turin, ITALIA	212
415057	18/11/2022		9, 18 y 25	BASIC PROPERTIES S.R.L.	LARGO MAURIZIO VITALE 1, 10152, TURIN, ITALIA	212
415057	15/11/2022		9, 18 y 25	SUPERGA TRADEMARK S.R.L.	LARGO MAURIZIO VITALE 1, 10152, TURIN, ITALIA	212
415175	08/11/2022	HILTON GARDEN INN	43	Hilton Worldwide Holding LLP	Maple Court Central Park, Reed Crescent., WD24 4QQ, Watford, United Kingdom	194

N° Exp.	Resolución	Denominación	Clases	Titular	Dirección	Ag.
415176	08/11/2022	HILTON GARDEN INN	43	Hilton Worldwide Holding LLP	Maple Court Central Park, Reed Crescent., WD24 4QQ, Watford, United Kingdom	194
415779	22/11/2022	SUSHI GOOOOO	43	DIEGO CHARLONE NADAL	Queguay N°8 , Parque Miramar, CANELONES, URUGUAY	
416025	25/10/2022	THE BRIDGE	18	IL PONTE S.p.A.	Via Codignola 14/16, Scandicci, FLORENCIA, ITALIA	18
416060	12/10/2022	LYRICA	5	C.P. PHARMACEUTICALS INTERNATIONAL C.V.	235 East 42nd Street, 10017, Nueva York, E. U. DE NORTEAMERICA	144
417704	21/11/2022	ICEBERG	3, 9, 14, 18 y 25	SEMINVEST INVESTMENTS B.V.	Via Malpasso 723/725 , 47842, San Giovanni in Marignano, RN, ITALIA	144
418550	07/11/2022	FOSFUR	5	THE LATIN AMERICA TRADEMARK CORPORATION	Ruta 101 Km. 23.500 Parque de las Ciencias, Edificio Mega Pharma, Piso 3, Colonia Nicolich, Canelones, URUGUAY	144
418884	13/10/2022	TIFON	6	FELICIANO ARANZABAL Y COMPAÑIA, S.A.	Etxabigel Notari Jauna Kalea, 20500, Mondragón , ESPAÑA	217
419771	07/11/2022		5	BOEHRINGER INGELHEIM KG	Ingelheim , ALEMANIA	136
419794	04/10/2022	PESTOXIN	1 y 5	ALICIA BEATRIZ PEREZ y HUMBERTO DAVID LANZAVECCHIA	JUNCAL N°1378, APARTAMENTO N° 1301, MONTEVIDEO, URUGUAY y JUNCAL N°1378, APARTAMENTO N° 1301, MONTEVIDEO, URUGUAY	34
420127	17/10/2022	JULIANA	28	JUEGOS Y JUGUETES SRL	Avenida Teniente General Donato, Ciudad Autónoma de Buenos Aires, ARGENTINA	234
420180	17/10/2022	GAES	10	GABINETES DE AUDIOPROTESIS,	Avenida de Madrid, 199 bajos, 50017 , Zaragoza, ESPAÑA	201

N° Exp.	Resolución	Denominación	Clases	Titular	Dirección	Ag.
				ELECTROMEDICINA Y SERVICIOS, S.A.		
420671	27/10/2022	DULCOVIVA	5, 29 y 30	BOEHRINGER INGELHEIM INTERNATIONAL GmbH	Brüningstrasse 50, 65926, Frankfurt am Main, ALEMANIA	136
421276	08/11/2022	HOME2 SUITES BY HILTON	43	Hilton Worldwide Holding LLP	Maple Court Central Park, Reed Crescent., WD24 4QQ, Watford, United Kingdom	194
421428	17/10/2022	BEL RAY	1, 3 y 4	Bel-Ray Company, L.L.C. a Delaware limited liability company	2780 Waterfront Parkway East Drive, Suite 200, 46214, Indianapolis, Indiana, E. U. DE NORTEAMERICA	192
421428	07/10/2022	BEL RAY	1, 3 y 4	Calumet Branded Products, LLC a Delaware limited liability company	2780 Waterfront Parkway East Drive, Suite 200, 46214, Indianapolis, Indiana, E. U. DE NORTEAMERICA	192
421428	14/10/2022	BEL RAY	1, 3 y 4	Bel-Ray Company, L.L.C. a New Jersey limited liability company	2780 Waterfront Parkway East Drive, Suite 200, 46214, Indianapolis, Indiana, E. U. DE NORTEAMERICA	192
421572	08/11/2022	D	43	Hilton Worldwide Holding LLP	Maple Court Central Park, Reed Crescent., WD24 4QQ, Watford, United Kingdom	194
422761	07/10/2022	BEL-RAY MOLYLUBE	1 y 4	Bel-Ray Company, L.L.C. a New Jersey limited liability company	P.O. Box 526, NJ 07727, Farmingdale, E. U. DE NORTEAMERICA	192
422924	27/10/2022	TOYWATCH	14, 28 y 35	TOYWATCH S.r.l.	9/A West Gate Tower 7 Wing Street, Lai Chi Kok, Kowloon, HONG KONG	34
423266	06/10/2022		25	WOLVERINE OUTDOORS, INC.	9341 Coutland Drive N.E., 49351, Rockford, MICHIGAN, E. U. DE NORTEAMERICA	194
423924	18/11/2022	TROP	5	ADAMA BRASIL S/A	P.O. Box 262, Northern	201

N° Exp.	Resolución	Denominación	Clases	Titular	Dirección	Ag.
					Industrial Zone, Ashdod, 7710201, ., ., ISRAEL	
424231	07/11/2022	ELEA	42, 43, 44 y 45	URUFARMA S.A.	Avenida Del Libertador 6550 3° Piso, Ciudad Autónoma de Buenos Aires, ARGENTINA	34
428233	08/11/2022	HILTON GRAND VACATIONS	36 y 43	Hilton Worldwide Holding LLP	Maple Court Central Park, Reed Crescent., WD24 4QQ, Watford, United Kingdom	194
428234	08/11/2022	HAMPTON BY HILTON	43	Hilton Worldwide Holding LLP	Maple Court Central Park, Reed Crescent., WD24 4QQ, Watford, United Kingdom	194
428235	03/11/2022	HAMPTON BY HILTON	43	HILTON WORLWIDE HOLDING LLP	Maple Court Central Park, Reed Crescent., WD24 4QQ, Watford, United Kingdom	194
428237	08/11/2022	HAMPTON INN & SUITES BY HILTON	43	HILTON WORLDWIDE HOLDING LLP	Maple Court Central Park, Reed Crescent., WD24 4QQ, Watford, United Kingdom	194
428238	08/11/2022	HAMPTON INN BY HILTON	43	Hilton Worldwide Holding LLP	Maple Court Central Park, Reed Crescent., WD24 4QQ, Watford, United Kingdom	194
428239	08/11/2022	HAMPTON INN & SUITES BY HILTON	43	Hilton Worldwide Holding LLP	Maple Court Central Park, Reeds Crescent, WD24 4QQ, Watford, United Kingdom	194
428885	08/11/2022		4, 7, 11, 12 y 16	YANMAR POWER TECHNOLOGY CO., LTD.	1-32 CHAYAMACHI, OSAKA, KITA-KU, OSAKA, JAPON	156
428947	18/10/2022	HYT	1	AGRINOS COLOMBIA S.A.S	Alajuela-San Carlos Muelle, 800 metros al norte de la estación de servicio muelle, Oficinas de grupo agricenter, Costa Rica, COSTA RICA	212
428948	18/10/2022	AGRINOS	1	AGRINOS COLOMBIA S.A.S	Alajuela-San Carlos Muelle, 800 metros al norte de la estación de servicio muelle, Oficinas de	212

N° Exp.	Resolución	Denominación	Clases	Titular	Dirección	Ag.
					grupo agricerter, Costa Rica, COSTA RICA	
429088	18/11/2022	ZAFF	25	CARLOS MARCELO GARCÍA MARTIN	Rbla . Republica de Chile 4643 apto. 601, MONTEVIDEO, URUGUAY	
429407	13/05/2022	LOG CABIN	30	Peak Finance Holdings LLC	222 Merchandise Mart Plaza, Suite 1300, 60654, Chicago, Illinois, E. U. DE NORTEAMERICA	194
430467	04/11/2022	LAFFY TAFFY	30	SOCIETE DES PRODUITS NESTLE S.A.	One Tower Lane, Oakbrook Terrace, illinois, E. U. DE NORTEAMERICA	156
431913	21/11/2022	CRACKLE	38	CPE Holdings, Inc.	132 E. Putnam Ave., 06807, Cos Coby, Connecticut, E. U. DE NORTEAMERICA	212
433345	10/11/2022	CEGLUTION	5	LABORATORIO GADOR S.A.	O´ Connor 555, Villa Sarmiento, Morón, Buenos Aires, ARGENTINA	165
433408	07/10/2022	BEL-RAY	4	Bel-Ray Company, L.L.C. a New Jersey limited liability company	P.O. Box 526, NJ 07727, Farmingdale, E. U. DE NORTEAMERICA	192
434613	23/05/2022	D DRACMA	9	NILDESUR S.A.	Av. Italia 6509, Montevideo, URUGUAY	189
435781	03/10/2022	ZODIAC	7 y 12	Z Nautic	11 Chemin de Rainneville, 74940, Annecy- Le- Vieux, FRANCIA	34
436076	09/11/2022	FRUTILLA GLAMOROSA	3	Unilever IP Holdings B.V.	Port Sunlight, Wirral, Merseyside, Wirral, GRAN BRETAÑA (REINO UNIDO)	136
437628	06/10/2022	AGUILA	32 y 33	GRISELDA HERNANDEZ	Avda. Garibaldi 2185, 11800, Montevideo, Montevideo, URUGUAY	28
438450	07/11/2022	SIAMO GALAXY	25	MAWI S.R.L.	Mac Eachen 1616, MONTEVIDEO, URUGUAY	245

N° Exp.	Resolución	Denominación	Clases	Titular	Dirección	Ag.
439997	06/10/2022	VANRELL	35, 41, 42, 43, 44 y 45	JUAN E. VANRELL S.A.	Marco Bruto 1005 apto. 506, URUGUAY	144
441203	11/11/2022	SAPOLIO	3	INTRADEVCO INDUSTRIAL S.A. y VAN CAMPEN INTERNATIONAL CORPORATION	Av. Produccion Nacional N° 188, Chorrillos, Lima, PERU	212
441459	06/10/2022	RUI	8	NANJING DE QUANINTERNATIONAL TRADE CO., LTD	CHANGFA CENTER, 17TH FLOOR OF B BUILDING,300 ZHONGSHAN EAST ROAD, Nanjing, CHINA	212
442219	09/11/2022		5	NOVARTIS AG	LINDENSTRASSE 8, ., CH-6340, BAAR, BAAR, SUIZA	201
443387	07/11/2022	DIONDEL	5	THE LATIN AMERICA TRADEMARK CORPORATION	Ruta 101 Km. 23.500 Parque de las Ciencias, Edificio Mega Pharma, Piso 3, Colonia Nicolich, Canelones, URUGUAY	144
443944	06/10/2022	VANRELL	35 y 45	JUAN E. VANRELL S.A.	Marco Bruto 1005 apto. 506, Montevideo , Montevideo , URUGUAY	144
444115	21/11/2022	CUTEX	3 y 8	REVLON CONSUMER PRODUCTS CORPORATION	One New York Plaza, 10004, New York, New York, E. U. DE NORTEAMERICA	192
444501	04/10/2022	JULES CANNET	25	Rafael Dodel Grodzienski y Sergio Dodel Grodzienski	José Martí 3284/801, Montevideo, URUGUAY y Pedro F. Berro 1328/703, Montevideo, URUGUAY	218
444692	18/10/2022	GEOFFREY BEENE	3	Cluett Peabody & Co. Inc.	1411 Broadway, 10018, New York, New York., E. U. DE NORTEAMERICA	201
445455	11/10/2022	KINDER JOY	30	SOREMARTEC S.A.	Findel Business Center, Complexe B, Rue de Treves, L-2632, FINDEL,	212

N° Exp.	Resolución	Denominación	Clases	Titular	Dirección	Ag.
					LUXEMBURGO	
446776	18/10/2022	STRONG DOG	31	MARIA CRISTINA PAYSSE y BALSUR ENTERPRISES S.A .	Haití N°1500, Montevideo, Montevideo, URUGUAY y Coronel Raiz N° 2249, MONTEVIDEO, URUGUAY	118
447003	08/11/2022	CLAIROL	3	NOXELL CORPORATION	4500 Park Granada, Suite 100, 91302, Calabasas , California, E. U. DE NORTEAMERICA	201
447177	03/11/2022	TUVI NEVADO	30	JUAN JACOBO TUVI BONOMI	Cooper 2296, MONTEVIDEO, URUGUAY	212
447230	17/10/2022	SAMSUNG	24	SAMSUNG C&T COPORATION	67, Sejong-daero, Jung-gu, Taepyung-ro 2-ka, SEOUL, COREA DEL SUR	144
448119	10/11/2022	TEYMA	37, 38, 39, 40 y 42	TEYMA URUGUAY S.A.	Misiones 1424 Piso 3, MONTEVIDEO, URUGUAY	154
448945	24/10/2022	EXPANCEL	1	AKZO NOBEL COATINGS INTERNATIONAL B.V.	Velperweg 76, 6824, Arnhem, BM, PAISES BAJOS	18
450235	18/10/2022		25	CLUETT, PEABODY & CO., INC.	1411 Broadway, 10018, New York, New York., E. U. DE NORTEAMERICA	201
452691	04/10/2022	THE FIRM OF GLOBAL CITIZENS	35, 36, 42 y 45	Henley & Partners Group HoldingsLtd.	Pendergardens Business Tower, Level 2, Saint Andrews Road, STJ 9023, St Julian's, Paceville, MALTA	219
456036	18/10/2022	DON FARRUCO	29 y 31	ROBERTO ITZAINA	José Martí 3284/301, Montevideo, URUGUAY y José Martí 3284/301, Montevideo, URUGUAY	28
456084	20/10/2022	ADVASTAB	1	PMC CINCINNATI, INC.	PMC Group Building , 1288 , Route 74, Suite 40, 08054, MT. LAUREL, NEW JERSEY, E. U. DE NORTEAMERICA	194
456698	22/11/2022	BIONEUROEMOCION	16, 41 y 44	ENRIC CORBERA	C. Maximí Fornes 31, Rubí,	34

N° Exp.	Resolución	Denominación	Clases	Titular	Dirección	Ag.
				SASTRE	Barcelona, ESPAÑA	
458585	07/11/2022	MERIDIAN ROEMMERS R	5	THE LATIN AMERICA TRADEMARK CORPORATION	Ruta 101 Km. 23.500 Parque de las Ciencias, Edificio Mega Pharma, Piso 3, Colonia Nicolich, Canelones, URUGUAY	144
459240	13/10/2022	NALON PINTURERIAS	2 y 35	PEDRO LONGO	Av. Brasil 2543, Montevideo, Montevideo, URUGUAY	219
459728	07/11/2022	NATURAL	30	THE LATIN AMERICA TRADEMARK CORPORATION	Ruta 101 Km. 23.500 Parque de las Ciencias, Edificio Mega Pharma, Piso 3, Colonia Nicolich, Canelones, URUGUAY	144
459992	26/10/2022		5	Boehringer Ingelheim International GmbH	Brüningstrasse 50, 65926, Frankfurt am Main, ALEMANIA	136
460360	21/11/2022	M&P	8, 13 y 28	AMERICAN OUTDOOR BRANDS SALES COMPANY	2100 Roosevelt Avenue, 01104, Springfield, MASSACHUSETTS, E. U. DE NORTEAMERICA	136
460474	20/10/2022	ADVAPAK	4	PMC Cincinnati, Inc.	PMC Group Building , 1288, Route 73, Suite 40, 08054, MT. LAUREL, NEW JERSEY, E. U. DE NORTEAMERICA	194
461697	31/10/2022	THE HOME DEPOT	35 y 42	Homer TLC, LLC	2455 Paces Ferry Road, NW, 30339, Atlanta, Georgia, E. U. DE NORTEAMERICA	194
462150	11/11/2022	ALIEN	3	Azzaro Mugler Beaute	14, Rue Royale, 75008, Paris, Paris, FRANCIA	144
463312	07/11/2022	ANNE KLEIN	18	PREMIER BRANDS IP LLC	230 Park Avenue , NEW YORK, NEW YORK, E. U. DE NORTEAMERICA	212
463697	28/06/2022	CRISTAR	21	CRISTAR TABLETOP S.A.S.	Carrera 48 32 B Sur 139 P 11, Envigado, Antioquia, COLOMBIA	34

N° Exp.	Resolución	Denominación	Clases	Titular	Dirección	Ag.
464987	26/10/2022	MINIMA MEDLEY	5	MEDLEY INDUSTRIA FARMACEUTICA LTDA.	Rua Macedo Costa 55, Jardim Santa Genebra , 13080-180, Campinas, Sao Paulo, BRASIL	165
465099	01/11/2022	AQUAPRIM	3	THE LATIN AMERICA TRADEMARK CORPORATION	Ruta 101 Km. 23.500, Parque de las Ciencias, Edificio Mega Pharma, Piso 3, Colonia Nicolich, Canelones, URUGUAY	144
465101	08/11/2022	LACTIBON FEM	3	THE LATIN AMERICA TRADEMARK CORPORATION	Ruta 101 Km. 23.500, Parque de las Ciencias, Edificio Mega, Piso 3, Colonia Nicolich, Canelones, URUGUAY	144
465332	03/11/2022	CUREFINI	5	RAMON EFRAIN VASQUEZ	153 SW 2nd. Road, 33129, MIAMI, FLORIDA, E. U. DE NORTEAMERICA	34
465415	07/11/2022	KETONAL PHARMAINVESTI	5	THE LATIN AMERICA TRADEMARK CORPORATION	Ruta 101 Km. 23.500 Parque de las Ciencias, Edificio Mega Pharma, Piso 3, Colonia Nicolich, Canelones, URUGUAY	144
465625	18/10/2022	DOROTHY GRAY	3	DECIRAL S.A.	Nueva Palmira 1819, MONTEVIDEO, URUGUAY	194
465670	01/11/2022	A ALEXANDRA PLATA	14	MARIA ALEJANDRA YAGÜE SÁNCHEZ	Avda de Europa, 34 Edif. C, 28224, Pozuelo de Alarcón, Madrid, ESPAÑA	105
465830	03/10/2022		25	Psycho Bunny Inc.	5001-5003 Levy Street, H4R2N9, St. Laurent, Quebec, CANADA	194
466132	04/11/2022	COPAG 139	28	COMPANHIA PAULISTA DE PAPEIS E ARTES GRAFICAS - COPAG	Avenida Engenheiro Luis Carlos Berrini, nº 1645, piso 3, sala 31 e 32, piso 4, sala 42, CEP: 04.571-011, Brooklin, SAO PAULO, BRASIL	34
466505	07/11/2022	IPEXAL	5	THE LATIN AMERICA	Ruta 101 Km. 23.500 Parque de	144

N° Exp.	Resolución	Denominación	Clases	Titular	Dirección	Ag.
				TRADEMARK CORPORATION	las Ciencias, Edificio Mega Pharma, Piso 3, Colonia Nicolich, Canelones, URUGUAY	
468085	04/11/2022	DF R ENTER- TAINMENT	35 y 41	DIEGO EZEQUIEL FINKELSTEIN	Virrey Loreto 1714, Piso 9, C1426DXF, Ciudad Autónoma de Buenos Aires, ARGENTINA	94
468528	25/10/2022	RESPIROL	5	URUFARMA S.A.	600, Blvd. de Maisonneuve West, 33rd floor, H3A-3J2, Montreal Quebec, CANADA	34
468660	10/11/2022	DA VINCI SI	10	Intuitive Surgical, Inc.	1020 Kifer Road, 94086, Sunnyvale, California, E. U. DE NORTEAMERICA	18
469509	09/11/2022	IMPULSE	3	Unilever IP Holdings B.V.	Port Sunlight, Wirral, CH62 4ZD, Merseyside, Merseyside, GRAN BRETAÑA (REINO UNIDO)	136
470700	25/10/2022	GREEN GENE F	5	LABORATORIO LIBRA S.A.	107, Ihyeon-ro 30 Beongil, Ghieung-gu, 16924, COREA DEL SUR	34
471061	06/05/2022	MOTIONSENSE	3	Unilever Global IP Limited	Port Sunlight, Wirral, Merseyside, GRAN BRETAÑA (REINO UNIDO)	136
471247	08/11/2022	MISS CLAIROL	3	NOXELL CORPORATION	4500 Park Granada, Suite 100, 91302, Calabasas , California, E. U. DE NORTEAMERICA	201
471364	22/11/2022	TONSIL	1 y 19	SÜD-CHEMIE IP GmbH & Co.KG	Rothausstrasse 61, CH-4132, MuttENZ, SUIZA	212
471435	30/09/2022	META4	9, 35 y 42	Meta Platforms, Inc.	1601 Willow Road, 94025, Menlo Park, California , E. U. DE NORTEAMERICA	194
471768	07/11/2022	QUIERASE!	5	THE LATIN AMERICA TRADEMARK CORPORATION	Ruta 101 Km. 23.500 Parque de las Ciencias, Edificio Mega Pharma, Piso 3, Colonia	144

N° Exp.	Resolución	Denominación	Clases	Titular	Dirección	Ag.
					Nicolich, Canelones, URUGUAY	
471848	26/10/2022	LYNEDEM	3 y 5	QUIMICA ARISTON URUGUAY S.A.	La Paz 2257, Montevideo, URUGUAY	165
471976	15/11/2022	WORKRITEFR	9 y 25	Workrite Uniform Company, LLC	251 Little Falls Drive, 19808, Wilmington, Delaware, E. U. DE NORTEAMERICA	212
472751	11/11/2022	ANGEL MUSE	3	Azzaro Mugler Beaute	14, Rue Royale, 75008, Paris, Paris, FRANCIA	144
473006	21/11/2022	SMITH & WESSON	13	AMERICAN OUTDOOR BRANDS SALES COMPANY	2100 Roosevelt Avenue, 01104, Springfield, MASSACHUSETTS, E. U. DE NORTEAMERICA	136
473543	11/11/2022	EL PARAISO	32	GASALA S.A.	TREINTA Y TRES 557 y Santa Teresa, SAN CARLOS, MALDONADO, URUGUAY	25
474237	22/11/2022	SPOLETO	43	NOVA UMBRIA EMPREENDIMIENTOS E PARTICIPAÇÕES LTDA.	RODOVIA DOS METALURGICOS, 9640, CASA DE PEDRA, VOLTA REDONDA , 27.258-000 , RIO DE JANEIRO, BRASIL	34
475235	07/11/2022	MENUIX	5	THE LATIN AMERICA TRADEMARK CORPORATION	Ruta 101 Km. 23.500 Parque de las Ciencias, Edificio Mega Pharma, Piso 3, Colonia Nicolich, Canelones, URUGUAY	144
475236	07/11/2022	MARTESIA	5	THE LATIN AMERICA TRADEMARK CORPORATION	Ruta 101 Km. 23.500 Parque de las Ciencias, Edificio Mega Pharma, Piso 3, Colonia Nicolich, Canelones, URUGUAY	144
475249	07/11/2022	ABRETIA	5	THE LATIN AMERICA TRADEMARK CORPORATION	Ruta 101 Km. 23.500, Parque de las Ciencias, Edificio Mega Pharma, Piso 3, Colonia	144

N° Exp.	Resolución	Denominación	Clases	Titular	Dirección	Ag.
					Nicolich, Canelones, URUGUAY	
475454	01/11/2022	UMBRELLA INTELLIGENT SISTEMA DE PROTECCIÓN BIOLÓGICA AOX COMPLEX FOTOLIASA DEFENSA CELULAR	3	THE LATIN AMERICA TRADEMARK CORPORATION	Ruta 101 Km. 23.500, Parque de las Ciencias, Edificio Mega Pharma, Piso 3, Colonia Nicolich, Canelones, URUGUAY	144
475942	09/11/2022	SIGNITOR	5	NOVARTIS AG.	LINDENSTRASSE 8, ., CH- 6340, BAAR, BAAR, SUIZA	201
476379	17/10/2022	ENTIRA	1	Performance Materials NA, Inc.	2211 H.H. DOW WAY, 48674, Midland, MICHIGAN, E. U. DE NORTEAMERICA	144
476820	21/11/2022	MEN'S FACTORY	35	FIDEMAN S.A.	F. Acuña de Figueroa 1753, Montevideo, Montevideo, URUGUAY	220
477133	08/11/2022	CLAIROL BEAUTIFUL COLLECTION	3	NOXELL CORPORATION	4500 Park Granada, Suite 100, 91302, Calabasas , California, E. U. DE NORTEAMERICA	201
477134	31/10/2022	CLAIROL LOVING CARE	3	NOXELL CORPORATION	4500 Park Granada, Suite 100, 91302, Calabasas , California, E. U. DE NORTEAMERICA	201
479574	18/10/2022	COPPER CHEF	21	INTERMARK LTDA.	1F, 15th Building, Tongfuyu Industrial, Park, Xinhe Road, Buchong, Community, Shajing Street, Bao'an District, Shenzhen, Guangdong, CHINA	201
480252	25/10/2022	RUBIK'S	9, 16, 18, 25 y 35	Rubik's Brand Ltd.	BOSTON HOUSE, BOSTON DRIVE , BOURNE END, Buckinghamshire, United Kingdom	144
480253	25/10/2022		9, 16, 18, 25 y 35	Rubik's Brand Ltd.	BOSTON HOUSE, BOSTON DRIVE, BOURNE END, Buckinghamshire, United Kingdom	144

N° Exp.	Resolución	Denominación	Clases	Titular	Dirección	Ag.
480254	25/10/2022		9, 16, 18, 25 y 35	Rubik's Brand Ltd.	BOSTON HOUSE, BOSTON DRIVE , BOURNE END, Buckinghamshire, United Kingdom	144
480255	25/10/2022		9, 16, 18, 25 y 35	Rubik's Brand Ltd.	BOSTON HOUSE, BOSTON DRIVE , BOURNE END, Buckinghamshire, United Kingdom	144
481655	09/11/2022	EPISENSE COMPLEX	3	Unilever IP Holdings B.V.	Port Sunlight, Wirral, Merseyside, Merseyside, GRAN BRETAÑA (REINO UNIDO)	136
482018	30/09/2022	META4	9	Meta Platforms, Inc.	1601 Willow Road, 94025, Menlo Park, California , E. U. DE NORTEAMERICA	194
482130	08/07/2022	HAIER	11	QINGDAO HAISHANG ZHICAI MANAGEMENT CONSULTING CO., LTD.	Haier Industrial Park, No.1 Haier Road, Laoshan District, Qingdao City, Shandong Province, CHINA	94
483675	21/11/2022	ULTRAZEPAM	5	ICLOS S.A.	Ruta 101 Km. 23.500 Parque de las Ciencias, Edificio Mega Pharma, Piso 3, Colonia Nicolich, Canelones, URUGUAY	144
484658	28/10/2022	DIRECTV + PLUS	38	THE AT&T MVPD GROUP LLC	One Rockefeller Plaza, NY 10020-2003, Nueva York, E. U. DE NORTEAMERICA	218
484659	08/11/2022	DIRECTV + PLUS	9	THE AT&T MVPD GROUP LLC	One Rockefeller Plaza, NY 10020-2003, Nueva York, E. U. DE NORTEAMERICA	218
487516	11/11/2022	A MEN	3	Azzaro Mugler Beaute	14 Rue Royale 75008, 75008, Paris, Paris, FRANCIA	144
488610	18/11/2022	MORVAL VONWILLER ADVISORS	35, 36 y 45	MORVAL VONWILLER ADVISORS S.A.	Rue Charles- Galland 18, 1206, Geneva, SUIZA	216

N° Exp.	Resolución	Denominación	Clases	Titular	Dirección	Ag.
489027	06/10/2022	UA UNIVERSAL ASSISTANCE	44	DUSFAL S.A.	ITUZAINGO 1312 Of. 202, Montevideo, URUGUAY	34
491630	09/11/2022	FRESHCARE	3	Unilever IP Holdings B.V.	Port Sunlight, Wirral, Merseyside, Wirral, GRAN BRETAÑA (REINO UNIDO)	136
492292	09/11/2022	DIRECTV	9, 38, 41 y 42	THE AT&T MVPD GROUP LLC	One Rockefeller Plaza, NY 10020-2003 , Nueva York, E. U. DE NORTEAMERICA	218
492293	09/11/2022		9, 38, 41 y 42	THE AT&T MVPD GROUP LLC	One Rockefeller Plaza, NY 10020-2003 , Nueva York, E. U. DE NORTEAMERICA	218
492294	09/11/2022	DIRECTV SPORTS	9, 38, 41 y 42	THE AT&T MVPD GROUP LLC	One Rockefeller Plaza, NY 10020-2003 , Nueva York, E. U. DE NORTEAMERICA	218
492295	09/11/2022	D SPORTS	9, 38, 41 y 42	THE AT&T MVPD GROUP LLC	One Rockefeller Plaza, NY 10020-2003 , Nueva York, E. U. DE NORTEAMERICA	218
492296	09/11/2022	DIRECTV VERLO ES VIVIRLO	9, 38, 41 y 42	THE AT&T MVPD GROUP LLC	One Rockefeller Plaza, NY 10020-2003 , Nueva York, E. U. DE NORTEAMERICA	218
492708	04/11/2022	IPRAN CFR	5	KANGSHENYUNGA S.A.	Ruta 8, Km 17,500, Edificio Celebra, Oficina 503 , MONTEVIDEO, URUGUAY	136
493220	20/10/2022	DELRIN	1	E.I.DU PONT DE NEMOURS AND COMPANY	974 Centre Road, 19805, Wilmington, Delaware, E. U. DE NORTEAMERICA	144
493417	06/10/2022	AXE CLICK	3	Unilever Global IP Limited	Port Sunlight, Wirral, Merseyside, GRAN BRETAÑA (REINO UNIDO)	136
493583	19/10/2022	PENINSULA INVERSTMENTS GROUP INC	35, 37 y 41	JOSEF PRESCHHEL y MAURICIO LEVITIN KIRCHHEIMER	Andes 1293/1003, Montevideo, Montevideo, URUGUAY; Av. a la Playa 16, apto. 010, Canelones, URUGUAY y Av. a la Playa 16, apto 010, Canelones,	154

N° Exp.	Resolución	Denominación	Clases	Titular	Dirección	Ag.
					URUGUAY	
494096	22/11/2022	CAFINA	11	Cafina AG	Zechenstr. 60, 32429, Minden, ALEMANIA	136
494891	09/11/2022	TODO POR EL JUEGO	38 y 41	THE AT&T MVPD GROUP LLC	One Rockefeller Plaza, NY 10020-2003 , Nueva York, E. U. DE NORTEAMERICA	218
497662	28/10/2022	EL INTERIOR DEL RUGBY DIRECTV SPORTS	38 y 41	THE AT&T MVPD GROUP LLC	One Rockefeller Plaza, NY 10020-2003 , Nueva York, E. U. DE NORTEAMERICA	218
498117	03/10/2022	NIO NEEDS ICE ONLY	33	NIOCOCKTAILS SRL	VIA ANSPERTO, 10, 20123, MILAN, ITALIA	34
498378	07/11/2022	LORD CHESELINE	3	Unilever IP Holdings B.V.	Port Sunlight, Wirral, ---, Merseyside, Merseyside, GRAN BRETAÑA (REINO UNIDO)	136
499666	18/10/2022	ARROW	25	CLUETT, PEABODY & CO., INC.	1411 Broadway, 10018, New York, New York., E. U. DE NORTEAMERICA	201
500228	06/10/2022	KINGPEN	9 y 34	FLRish IP, LLC	2100 Embarcadero Street, Suite 205, 94606, California, Oakland, E. U. DE NORTEAMERICA	216
502236	09/11/2022	DE FÚTBOL SE HABLA ASÍ DIRECTV SPORTS	38 y 41	THE AT&T MVPD GROUP LLC	One Rockefeller Plaza, NY 10020-2003 , Nueva York, E. U. DE NORTEAMERICA	218
502240	09/11/2022	DE FÚTBOL SE HABLA ASÍ DIRECTV SPORTS	38 y 41	THE AT&T MVPD GROUP LLC	One Rockefeller Plaza, NY 10020-2003 , Nueva York, E. U. DE NORTEAMERICA	218
502579	09/11/2022	CONEXIÓN DIRECTV	38 y 41	THE AT&T MVPD GROUP LLC	One Rockefeller Plaza, NY 10020-2003 , Nueva York, E. U. DE NORTEAMERICA	218
503096	06/10/2022	SONIA RYKIEL	25	SONIA R. PROPERTIES SA	Chemin du Pré-Fleuri 5, 1228, Plan-les-Ouates, SUIZA	201
503784	09/11/2022	EL JUEGO DIRECTV SPORTS	38 y 41	THE AT&T MVPD GROUP LLC	One Rockefeller Plaza, NY 10020-2003 , Nueva York, E. U. DE NORTEAMERICA	218

N° Exp.	Resolución	Denominación	Clases	Titular	Dirección	Ag.
504280	09/11/2022	ISTURISA	5	NOVARTIS AG.	LINDENSTRASSE 8, ., CH-6340, BAAR, BAAR, SUIZA	201
504281	09/11/2022		5	NOVARTIS AG.	LINDENSTRASSE 8, ., CH-6340, BAAR, BAAR, SUIZA	201
504449	18/10/2022	ARROW	25	CLUETT, PEABODY & CO., INC.	1411 Broadway, 10018, New York, New York., E. U. DE NORTEAMERICA	201
504534	08/11/2022	NATURAL INSTINCTS	3	NOXELL CORPORATION	4500 Park Granada, Suite 100, 91302, Calabasas , California, E. U. DE NORTEAMERICA	201
504649	27/10/2022	FUNDACION RALLI	41	VIRGINIA SERRANA PRUNELL FALGUERAS	LOS ARRAYANES ESQ. PITANGAS, 20100, Punta del Este, Maldonado, URUGUAY	
505955	08/11/2022	NICE'N EASY	3	NOXELL CORPORATION	4500 Park Granada, Suite 100, 91302, Calabasas , California, E. U. DE NORTEAMERICA	201
507687	05/10/2022	DETERPLAS	5	NATILSUR S.A.	Monte Caseros 3091, Montevideo, URUGUAY	34
508151	09/11/2022	MARCA FEMENINA DIRECTV SPORTS	38 y 41	THE AT&T MVPD GROUP LLC	One Rockefeller Plaza, NY 10020-2003 , Nueva York, E. U. DE NORTEAMERICA	218
508152	09/11/2022	RANKING DIRECTV SPORTS	38 y 41	THE AT&T MVPD GROUP LLC	One Rockefeller Plaza, NY 10020-2003 , Nueva York, E. U. DE NORTEAMERICA	218
508153	09/11/2022	DIRECTV SPORTS GAMING	38 y 41	THE AT&T MVPD GROUP LLC	One Rockefeller Plaza, NY 10020-2003 , Nueva York, E. U. DE NORTEAMERICA	218
508277	06/10/2022	AGUILA	32 y 33	GRISELDA HERNANDEZ	Avda. Garibaldi 2185, Montevideo, 11800, Montevideo, Montevideo, URUGUAY	28
508287	06/10/2022	PICO DE AGUILA	32 y 33	GRISELDA HERNANDEZ	Avda. Garibaldi 2185, 11800, Montevideo, Montevideo, URUGUAY	28
508291	06/10/2022	AGUILA DEL PLATA	32 y 33	GRISELDA	Avda. Garibaldi 2185,	28

N° Exp.	Resolución	Denominación	Clases	Titular	Dirección	Ag.
				HERNANDEZ	Montevideo, 11800, Montevideo, Montevideo, URUGUAY	
508317	07/10/2022	FEXALER	5	LABORATORIOS CELSIUS S.A.	Avda. Joaquin Suarez 3593, MONTEVIDEO, URUGUAY	144
509997	06/10/2022	DUCK	16 y 17	SHURTAPE TECHNOLOGIES, LLC.	1712 Eighth Street Drive, SE Hickory, 28602, North Carolina, North Carolina, E. U. DE NORTEAMERICA	19
512357	09/11/2022	HILOS DIRECTV SPORTS	38 y 41	THE AT&T MVPD GROUP LLC	One Rockefeller Plaza, NY 10020-2003 , Nueva York, E. U. DE NORTEAMERICA	218
512370	01/11/2022	PLASTICOIN EL VALOR DE RECICLAR	9, 35, 36, 39 y 41	Nicole Wyaux y Juan Rivero	Arazá 705, Maldonado, URUGUAY	216
514537	30/09/2022	META4 PEOPLENET	9, 37 y 42	Meta Platforms, Inc.	1601 Willow Road, 94025, Menlo Park, California , E. U. DE NORTEAMERICA	194
514539	30/09/2022	META4MIND	9, 37 y 42	Meta Platforms, Inc.	601 Willow Road, 94025, Menlo Park, California , E. U. DE NORTEAMERICA	194
514749	06/10/2022	DEVOTION	3	Dolce & Gabbana Trademarks S.r.l.	Via Goldoni 10, 20129, Milano, ITALIA	144
515271	30/09/2022	META4	9 y 37	Meta Platforms, Inc.	1601 Willow Road, 94025, Menlo Park, California , E. U. DE NORTEAMERICA	194
515767	26/10/2022	SIXTYSEVEN	18, 25 y 35	PASCUAL ROS VIDAL; SERGIO ROS VIDAL; MARIA DEL MAR ROS VIDAL y SANTIAGO ROS VIDAL	SEVERO OCHOA, N° 36, ELCHE PARQUE INDUSTRIAL , ELCHE, ALICANTE, ESPAÑA	34
516047	06/10/2022	SURF	3	Unilever Global IP Limited	Port Sunlight, Wirral, Merseyside, GRAN BRETAÑA (REINO UNIDO)	136
518069	17/10/2022	VAN HEUSEN	25	PVH CORP.	1411 Broadway , 10018, New York, New York , E. U. DE	201

N° Exp.	Resolución	Denominación	Clases	Titular	Dirección	Ag.
					NORTEAMERICA	
518125	06/10/2022	DUCK TAPE	16 y 17	SHURTAPE TECHNOLOGIES, LLC.	1712 Eighth Street Drive, SE Hickory, 28602, North Carolina, North Carolina, E. U. DE NORTEAMERICA	19
518165	26/10/2022	FRIGONAL	29, 30 y 31	Anticuario S.A	RAMBLA ARMENIA 3655 OF. 202, MONTEVIDEO, URUGUAY	
519132	18/10/2022	ARROW	24 y 25	CLUETT, PEABODY & CO., INC.	1411 Broadway, 10018, New York, New York., E. U. DE NORTEAMERICA	201
519681	06/10/2022	CREDISOL PREPAGA	36	FLODER S.A.	Av. Luis Alberto de Herrera 1248 – WTC Torre 2 Oficina 211 , MONTEVIDEO, URUGUAY	94
521433	18/10/2022	ALTIUS RENTALS	36	ALTIUS GROUP S.R.L.	PLAZA INDEPENDENCIA 848 PISO 1, MONTEVIDEO, URUGUAY	201
522375	17/10/2022	IZOD	25	PVH CORP.	1411 Broadway , 10018, New York, New York , E. U. DE NORTEAMERICA	201
529257	18/11/2022	VIDAPESOS	38, 44 y 45	COMPAÑÍA DE LOGISTICA S.R.L.	Martin C. Martínez 2461, Montevideo, Montevideo, Montevideo, URUGUAY	144
533697	28/10/2022	DIRECTV SPORTS FIGHT	38 y 41	THE AT&T MVPD GROUP LLC	One Rockefeller Plaza, NY 10020-2003, Nueva York, E. U. DE NORTEAMERICA	218
533701	28/10/2022	DIRECTV BOXING	38 y 41	THE AT&T MVPD GROUP LLC	One Rockefeller Plaza, NY 10020-2003, Nueva York, E. U. DE NORTEAMERICA	218
533702	28/10/2022	BOXING DIRECTV SPORTS	38 y 41	THE AT&T MVPD GROUP LLC	One Rockefeller Plaza, NY 10020-2003, Nueva York, E. U. DE NORTEAMERICA	218
533703	28/10/2022	D SPORTS BOXING	38 y 41	THE AT&T MVPD GROUP LLC	One Rockefeller Plaza, NY 10020-2003, Nueva York, E. U.	218

N° Exp.	Resolución	Denominación	Clases	Titular	Dirección	Ag.
					DE NORTEAMERICA	
535273	06/10/2022	GREENCASTLE	16	FCS Comercial Importadora e Exportadora Ltda.	Rua Cel. José Augusto de Oliveira Salles, 1876, DEX Mezanino, sala 3, 2° andar, Distrito Industrial, CEP 13570-820, São Carlos SP, BRASIL	194
537009	17/10/2022	VAN HEUSEN	25	PVH CORP.	1411 Broadway , 10018, New York, New York , E. U. DE NORTEAMERICA	201
540198	17/10/2022	LAUNDRY BY SHELLI SEGAL	3 y 25	PERRY ELLIS INTERNATIONAL GROUP HOLDINGS LIMITED	Olympic House, Pleasants Street, Dublin 8, IRLANDA	194

TRANSFERENCIAS DESESTIMADAS (Art. 92, D. 34/999)

N° Exp.	Resolución	Denominación	Clases	Titular	Dirección	Ag.
407009	05/10/2022	SIERRATUR VIAJES TURISMO	39	OSCAR ARNOLDO RUIZ DELGADO	Morales Arrillaga 1140, Minas, URUGUAY	172

TRANSFERENCIAS PARCIALES

N° Exp.	Resolución	Denominación	Clases	Titular	Dirección	Ag.
398884	09/11/2022	GORGA INMOBILIARIA	35 y 36	MARIA IRENE GORGA AROSA y RICARDO JOSÉ PEDRO GORGA AROSA	Bulevar Artigas 2915, Montevideo, Montevideo, URUGUAY	20
455794	20/10/2022	GIN MARE MEDITERRANEAN GIN	33	MARELIQUID VANTGUARD, S.L.	Monte Esquinza, 24, 28010, Madrid, ESPAÑA y Miquel Guanse s/n°, 08800, VILANOVA I LA GELTRU, ESPAÑA	201
455794	20/10/2022	GIN MARE MEDITERRANEAN GIN	33	DESTILERIAS M.G., S.L. y GLOBAL PREMIUM BRANDS,	Monte Esquinza, 24, 28010, Madrid, ESPAÑA y Miquel Guanse s/n°, 08800, VILANOVA	201

N° Exp.	Resolución	Denominación	Clases	Titular	Dirección	Ag.
				S.A.	I LA GELTRU, ESPAÑA	
516219	03/10/2022	ÓPTICA RIO	44	Mary Gabriela Vazquez Alonso y Rossana Vazquez	Juan Benito Blanco 967, Montevideo, -, Montevideo, Montevideo, URUGUAY y Cnel Alegre 1181 Apto 102, Montevideo, URUGUAY	212

TRANSFERENCIAS DE FRASES PUBLICITARIAS

N° Exp.	Resolución	Denominación	Clases	Titular	Dirección	Ag.
421205	08/11/2022	LO MAS IMPORTANTE ESTA EN LOS PEQUEÑOS DETALLES	43	Hilton Worldwide Holding LLP	Maple Court Central Park, Reed Crescent., WD24 4QQ, Watford, United Kingdom	194
435266	07/11/2022	CON-CIENCIA DERMATOLÓGICA PARA UNA PIEL SALUDABLE	3 y 5	THE LATIN AMERICA TRADEMARK CORPORATION	Ruta 101 Km. 23.500 Parque de las Ciencias, Edificio Mega Pharma, Piso 3, Colonia Nicolich, Canelones, URUGUAY	144
519682	06/10/2022	CREDISOL, CUANTO MÁS TE CONOCEMOS, MENOS PAGÁS	36	FLODER S.A.	Av. Luis Alberto de Herrera 1248 – WTC Torre 2 Oficina 211 , MONTEVIDEO, URUGUAY	94

TRANSFERENCIAS DE PATENTES

N° Exp.	Resolución	Titular	Dirección	Ag.
025680	07/10/2022	BRITISH AMERICAN TOBACCO (INVESTMENTS) LIMITED.		20
029208	07/10/2022	Spectrum Brands Inc.		165
032668	07/10/2022	AbbVie Ireland Unlimited Sasson House Company		205
032776	06/10/2022	Novartis International Pharmaceutical Ltd.		194
033815	12/06/2017	NOVARTIS AG.		94
034398	17/10/2022	UNGER THOMAS ALFRED		34
035883	30/09/2022	Vrio Corp.		218
036047	06/10/2022	UNIVERSIDAD DE LA REPUBLICA		

N° Exp.	Resolución	Titular	Dirección	Ag.
036841	04/10/2022	FMC Corporation		221
037100	04/10/2022	Genvec Inc.; The Government of the United States of America, as represented by the Secretary of Homeland Security y Boehringer Ingelheim Animal Health USA, Inc.		221
037100	11/10/2022	Genvec Inc.; The Government of the United States of America, as represented by the Secretary of Homeland Security y Boehringer Ingelheim Animal Health USA		221
037179	03/11/2022	Universidad Pública de Navarra; Consejo Superior De Investigaciones Científicas y IDEN BIOTECHNOLOGY, S.L.		245
037778	04/11/2022	LES LABORATOIRES SERVIER		18
038566	31/10/2022	Andritz Oy; Metsä Fibre Oy y Teknologian tutkimuskeskus VTT Oy		136
039188	04/11/2022	Janssen Biotech, Inc.		192
039224	11/11/2022	AMGEN INC.		216

CAMBIOS DE NOMBRE

N° Exp.	Resolución	Denominación	Clases	Titular	Dirección	Ag.
372952	17/10/2022	BENETTON	25	BENCOM S.R.L.	Via Villa Minelli 1, 31050, Ponzano Veneto, Treviso, ITALIA	144
381622	20/10/2022	FELTRIN	31	FELTRIN IMPORTADORA DE SEMENTES LTDA.	Rua thomazo Radaelli, 368, Farroupilha, Rio Grande do Sul, BRASIL	34
393106	11/11/2022	IUS LABORIS	35, 41 y 45	IUS LABORIS S.C.R.L.	280 Boulevard du Souverain, B-1160, Bruselas, BELGICA	18
394392	31/10/2022	ALTAMA	25	The Original Footwear Company, Inc.	5968 Commerce Blvd., 37814, Morristown,, TN, E. U. DE NORTEAMERICA	136
396444	07/11/2022	STEVIVUS	5	EUROFARMA GAUTIER URUGUAY	Democracia 2132, Montevideo, Montevideo, URUGUAY	201

N° Exp.	Resolución	Denominación	Clases	Titular	Dirección	Ag.
				S.A.		
399400	04/11/2022	ROCHEDO LUNA	21	GRUPO SEB DO BRASIL PRODUTOS DOMÉSTICOS LTDA.	Avenida Álvaro Guimarães, 1.100, Planalto, São Bernardo do Campo, São Paulo, BRASIL	34
400103	07/11/2022	BE GLAM	3	TUPPERWARE PRODUCTS S.A.	Route du Jura 37, 1700, Friburgo, SUIZA	34
401064	01/11/2022	BEAUTY RUSH	3	VICTORIA'S SECRET STORES BRAND MANAGEMENT, INC.	Four Limited Parkway, Reynoldsburg, 43068, Ohio, E. U. DE NORTEAMERICA	212
401065	01/11/2022	VICTORIA'S SECRET PINK	3, 25 y 35	VICTORIA'S SECRET STORES BRAND MANAGEMENT, INC.	Four Limited Parkway, Reynoldsburg, 43068, Ohio, E. U. DE NORTEAMERICA	212
401066	01/11/2022	AMBER ROMANCE	3	VICTORIA'S SECRET STORES BRAND MANAGEMENT, INC.	Four Limited Parkway, Reynoldsburg, 43068, Ohio, E. U. DE NORTEAMERICA	212
401067	01/11/2022	DREAM ANGELS BY VICTORIA'S SECRET	3	VICTORIA'S SECRET STORES BRAND MANAGEMENT, INC.	Four Limited Parkway, Reynoldsburg, 43068, Ohio, E. U. DE NORTEAMERICA	212
401068	01/11/2022	ENDLESS LOVE	3	VICTORIA'S SECRET STORES BRAND MANAGEMENT, INC.	Four Limited Parkway, Reynoldsburg, 43068, Ohio, E. U. DE NORTEAMERICA	212
401069	01/11/2022	ROMANTIC WISH	3	VICTORIA'S SECRET STORES BRAND MANAGEMENT, INC.	Four Limited Parkway, Reynoldsburg, 43068, Ohio, E. U. DE NORTEAMERICA	212
401071	01/11/2022	SWEET DAYDREAM	3	VICTORIA'S SECRET STORES BRAND MANAGEMENT, INC.	Four Limited Parkway, Reynoldsburg, 43068, Ohio, E. U. DE NORTEAMERICA	212
401072	01/11/2022	VICTORIA'S SECRET GARDEN	3	VICTORIA'S SECRET STORES BRAND MANAGEMENT, INC.	Four Limited Parkway, Reynoldsburg, 43068, Ohio, E. U. DE NORTEAMERICA	212
401073	01/11/2022	VICTORIA'S SECRET PURE SEDUCTION	3	VICTORIA'S SECRET STORES BRAND MANAGEMENT, INC.	Four Limited Parkway, Reynoldsburg, 43068, Ohio, E. U. DE NORTEAMERICA	212
401075	03/11/2022	PEAR GLACE	3	VICTORIA'S SECRET	Four Limited Parkway,	212

N° Exp.	Resolución	Denominación	Clases	Titular	Dirección	Ag.
				STORES BRAND MANAGEMENT, INC.	Reynoldsburg, 43068, Ohio, E. U. DE NORTEAMERICA	
401076	03/11/2022	VICTORIA'S SECRET VERY SEXY FOR HIM	3	VICTORIA'S SECRET STORES BRAND MANAGEMENT, INC.	Four Limited Parkway, Reynoldsburg, 43068, Ohio, E. U. DE NORTEAMERICA	212
401077	03/11/2022	VICTORIA'S SECRET VERY SEXY FOR HER	3	VICTORIA'S SECRET STORES BRAND MANAGEMENT, INC.	Four Limited Parkway, Reynoldsburg, 43068, Ohio, E. U. DE NORTEAMERICA	212
401078	03/11/2022	SUPERMODEL BY VICTORIA'S SECRET	3	VICTORIA'S SECRET STORES BRAND MANAGEMENT, INC.	Four Limited Parkway, Reynoldsburg, 43068, Ohio, E. U. DE NORTEAMERICA	212
401079	03/11/2022	SEXY LITTLE THINGS	3	VICTORIA'S SECRET STORES BRAND MANAGEMENT, INC.	Four Limited Parkway, Reynoldsburg, 43068, Ohio, E. U. DE NORTEAMERICA	212
401080	03/11/2022	DREAM ANGELS WISH	3	VICTORIA'S SECRET STORES BRAND MANAGEMENT, INC.	Four Limited Parkway, Reynoldsburg, 43068, Ohio, E. U. DE NORTEAMERICA	212
401081	03/11/2022	DREAM ANGELS HEAVENLY	3	VICTORIA'S SECRET STORES BRAND MANAGEMENT, INC.	Four Limited Parkway, Reynoldsburg, 43068, Ohio, E. U. DE NORTEAMERICA	212
401794	03/11/2022	SERGIO TACCHINI	18	SERGIO TACCHINI INTERNATIONAL S.P.A. IN LIQUIDAZIONE	Galleria Sala dei Longobardi 2, 20121, MILANO, ITALIA	165
402137	08/11/2022	UVEX BY SPERIAN	2, 9 y 35	Sperian Protection Americas, Inc.	900 Douglas Pike, 02917, Smithfield, Rhode Island, E. U. DE NORTEAMERICA	34
402440	07/11/2022	RESPONSIBLE CARE OUR COMMITMENT TO SUSTAINABILITY PROGRAMA CUIDADO RESPONSABLE DEL MEDIO AMBIENTE	1, 35, 41 y 42	ASIQR ASOCIACION DE INDUSTRIAS QUIMICAS DEL URUGUAY	Av. Italia 6101, 11500, Montevideo, Montevideo, URUGUAY	94
403287	08/11/2022	DUCIEL	20 y 24	LAMITEX S.R.L.	Camino Repetto 4648,	

N° Exp.	Resolución	Denominación	Clases	Titular	Dirección	Ag.
					Montevideo, Montevideo, Montevideo, URUGUAY	
404265	08/11/2022	EUROFARMA	5	EUROFARMA LABORATÓRIOS LTDA.	Avenida Vereador José Diniz N°3465, 04.603-003, Campo Belo, São Paulo, BRASIL	228
405359	07/11/2022	IMUSA	21	GROUPE SEB COLOMBIA S.A.	KM 40 AUTOPISTA MEDELLIN-BOGOTA, VEREDA GALICIA, Rionegro, Antioquia, COLOMBIA	34
405842	11/11/2022	MONEY BURST	9	Bally Gaming, Inc.	6601 Bermuda Road, 89119, Las Vegas, Nevada, E. U. DE NORTEAMERICA	144
405844	15/11/2022	HOT HOT SUPER RESPIN	9	Bally Gaming, Inc.	6601 Bermuda Road, 89119, Las Vegas, Nevada, E. U. DE NORTEAMERICA	144
406507	10/11/2022	BON VIVART	35, 41 y 43	TERRAMAR S.R.L.	Ruta 10 km. 160, La Barra, Maldonado, URUGUAY	181
407000	12/10/2022	ALMAGOR	5	IRVITA PLANT PROTECTION, A BRANCH OF CELSIUS PROPERTY B.V.	Pos Cabai Office Park Unit 13, Curacao, Curacao, PAISES BAJOS	144
409376	07/11/2022	SKINMEN	3	TUPPERWARE PRODUCTS S.A.	Route du Jura 37, Fribourg, SUIZA	34
409685	08/11/2022	ARQUI P.O.P.	16, 20, 35 y 37	ARQUI FOAM S.R.L.	Juan José de Amézaga 2206, Montevideo, Montevideo, URUGUAY	189
409775	08/11/2022	UNIDAD CORONARIA MOVIL	36 y 39	PERSES S.A.	José Mazzini 2957, Montevideo, Montevideo, URUGUAY	34
410706	09/11/2022	NAVIGATOR	16	Navigator Paper Figueira, S.A.	Lavos, 3081-851, Figueira Da Foz, PORTUGAL	144
410923	17/11/2022	EL GALLO MAS GALLO	35	GMG NICARAGUA SOCIEDAD ANÓNIMA	Carretera Norte, Managua, NICARAGUA	181
411695	24/10/2022	THE WEATHER CHANNEL EL CANAL DEL TIEMPO	9, 38, 41 y 42	THE WEATHER CHANNEL , LLC	300 Interstate North Parkway, ATLANTA, Georgia, E. U. DE	20

N° Exp.	Resolución	Denominación	Clases	Titular	Dirección	Ag.
					NORTEAMERICA	
411695	21/10/2022	THE WEATHER CHANNEL EL CANAL DEL TIEMPO	9, 38, 41 y 42	THE WEATHER CHANNEL INTERACTIVE, LLC	300 Interstate North Parkway, ATLANTA, Georgia, E. U. DE NORTEAMERICA	20
413437	10/11/2022		38 y 41	THE DIRECTV GROUP, INC.	2230 East Imperial Hwy, El Segundo, California, E. U. DE NORTEAMERICA	218
415055	15/11/2022	PEOPLE´S SHOES OF ITALY	25	SUPERGA TRADEMARK S.A.	LARGO MAURIZIO VITALE 1, 10152, TURIN, ITALIA	212
415057	10/11/2022		9, 18 y 25	SUPERGA TRADEMARK S.A.	LARGO MAURIZIO VITALE 1, 10152, TURIN, ITALIA	212
415617	06/10/2022	TOBRADOSA	5	LABORATORIO LKM S.A.	Montevideo 589, piso 4, c1019abk, C. Aut. de Buenos Aires, Buenos Aires, ARGENTINA	167
416025	13/10/2022	THE BRIDGE	18	IL PONTE FINANZIARIA S.P.A..	Via Codignola 14/16, Scandicci, FLORENCIA, ITALIA	18
416025	24/10/2022	THE BRIDGE	18	IL PONTE S.R.L.	Via Codignola 14/16, Scandicci, FLORENCIA, ITALIA	18
416025	31/10/2022	THE BRIDGE	18	IL PONTE PELLETTERIA S.p.A.	Via Codignola 14/16, Scandicci, FLORENCIA, ITALIA	18
416803	24/10/2022	HALEXISTAR	5	HALEX ISTAR INDÚSTRIA FARMACÊUTICA LTDA.	BR 153 - Km 03 - Rodovia Federal, Conjunto Caiçara, Chácara Retiro, Goiania, Goiás, BRASIL	228
417532	08/11/2022	CITROLE	1 y 5	TOTAL S.A.	2 Place Jean Millier La Defense 6, 92400 , Courbevoie , FRANCIA	201
418452	01/11/2022	LOVE ADDICT	3	VICTORIA'S SECRET STORES BRAND MANAGEMENT, INC.	Four Limited Parkway, Reynoldsburg, Ohio, E. U. DE NORTEAMERICA	212
418511	10/11/2022	BOVIMILK	31	SOLAPA S.A.	Ruta 5, Km 58,7, Canelones, URUGUAY	245
419123	17/10/2022	LUMAX	7, 9 y 11	CINAMON S.R.L.	SORIANO 932,	189

N° Exp.	Resolución	Denominación	Clases	Titular	Dirección	Ag.
					MONTEVIDEO, URUGUAY	
420615	03/11/2022	VS FANTASIES	3	VICTORIA'S SECRET STORES BRAND MANAGEMENT, INC	Four Limited Parkway, 43068, Reynoldsburg, Ohio , E. U. DE NORTEAMERICA	212
421571	03/11/2022	DRENCHED IN PINK	3	VICTORIA'S SECRET STORES BRAND MANAGEMENT, INC.	Four Limited Parkway, Reynoldsburg, Ohio, E. U. DE NORTEAMERICA	212
421786	03/11/2022	VANILLA LACE	3	VICTORIA'S SECRET STORES BRAND MANAGEMENT, INC	Four Limited Parkway, 43068, Reynoldsburg, Ohio , E. U. DE NORTEAMERICA	212
422016	07/11/2022	AZO	6, 7, 9 y 19	AZO Holding GmbH	28 Rosenberg Strasse., D-74706, Osterburken, ALEMANIA	144
422216	03/11/2022	VICTORIA'S SECRET THE MIRACLE BRA	25	VICTORIA'S SECRET STORES BRAND MANAGEMENT, INC.	Four Limited Parkway, Reynoldsburg, Ohio, E. U. DE NORTEAMERICA	212
422924	18/10/2022	TOYWATCH	14, 28 y 35	TOYWATCH S.P.A.	9/A West Gate Tower 7 Wing Street, Lai Chi Kok, Kowloon, HONG KONG	34
423396	03/11/2022	VICTORIA'S SECRET GORGEOUS	3 y 25	VICTORIA'S SECRET STORES BRAND MANAGEMENT, INC	Four Limited Parkway, 43068, Reynoldsburg, Ohio , E. U. DE NORTEAMERICA	212
423557	21/10/2022	HOBAS	7, 19 y 42	HOBAS ENGINEERING GMBH	Pischeldorfer Str. 128, A-9020, Klagenfurt, AUSTRIA	179
423557	24/10/2022	HOBAS	7, 19 y 42	HOBAS Pipes InternaFonal GmbH	Pischeldorfer Str. 128, A-9020, Klagenfurt, AUSTRIA	179
423582	07/11/2022	WHATSAPP	9 y 38	WHATSAPP INC.	3561 Homestead Road, 416, CA 95051-5161, California, E. U. DE NORTEAMERICA	194
423798	03/11/2022	DREAM ANGELS FOREVER	3	VICTORIA'S SECRET STORES BRAND MANAGEMENT, INC.	Four Limited Parkway, 43068, Reynoldsburg, Ohio, E. U. DE NORTEAMERICA	212
424414	10/11/2022	SIM - SMILES - INCENTIVE MILES	39	VRG LINHA AÉREAS S.A.	Praça Senador Salgado Filho, s/nº, Aeroporto, Santos Dumont, térreo, área pública, entre os	201

N° Exp.	Resolución	Denominación	Clases	Titular	Dirección	Ag.
					eixos 46-48/O-P, Sala da Gerência Back Office, Rio de Janeiro, BRASIL	
426300	09/11/2022	DIRECTV NEXUS	9, 38, 41 y 42	THE DIRECTV GROUP, INC.	2230 East Imperial Hwy, 90245, El Segundo, CA, E. U. DE NORTEAMERICA	218
426417	04/11/2022	PENEDO	20, 21 y 30	GRUPO SEB DO BRASIL PRODUTOS DOMÉSTICOS LTDA.	Av. Arno, n° 146, parte Mooca , 031800-900, São Paulo, BRASIL	34
426930	10/11/2022	DIRECTV NOMAD	9, 38, 41 y 42	THE DIRECTV GROUP, INC.	2230 E. Imperial Highway, 90245, El Segundo - , California, E. U. DE NORTEAMERICA	218
427052	20/10/2022	PIGEON	7	ZHENGYANG INDUSTRY & INVESTMENT CO., LTD.	No.558 Greatwall East Road, Economic Development Zone, Yongkang, JINHUA , ZHEJIANG, CHINA	144
427567	01/11/2022	VICTORIA'S SECRET RAPTURE	3 y 25	VICTORIA'S SECRET STORES BRAND MANAGEMENT, INC.	Four Limited Parkway, 43068, Reynoldsburg, Ohio, E. U. DE NORTEAMERICA	212
429541	15/11/2022	REYNOLDS	16	REYNOLDS CONSUMER PRODUCTS, INC.	6603 West Broad Street, 23230, Richmond, Virginia, E. U. DE NORTEAMERICA	34
432198	28/10/2022	TOPEX	5	DENTSPLY INTERNATIONAL INC.	221 west philadelphia street, 17405, York, PA, E. U. DE NORTEAMERICA	194
433769	09/11/2022	PROTTO	35	LEXA S.A.	Paysandú 834, Montevideo, Montevideo, URUGUAY	104
434646	07/11/2022	YANMAR	12	YANMAR CO. LTD.	1-32 CHAYAMACHI, Kyta-Ku, Osaka, JAPON	156
435597	21/10/2022	AC	18 y 25	COURREGES DESIGN	40, rue François 1er., 75008, Paris, FRANCIA	201
435781	04/10/2022	ZODIAC	7 y 12	Z Nautic	11 Chemin de Rainneville, 74940, Annecy- Le- Vieux, FRANCIA	34

N° Exp.	Resolución	Denominación	Clases	Titular	Dirección	Ag.
436113	18/10/2022	MUY INTERESANTE	41	EDITORIAL G Y J TELEVISA, S.A. DE C.V.	Av. Vasco de Quiroga Número 2000, 01210, Delegación Alvaro Obregón, Colonia Santa Fé, MEXICO	34
436904	10/11/2022	PROFUGAL	5	ROEMMERS S.A.	Cno. Maldonado 5634, Montevideo, Montevideo, URUGUAY	144
437973	04/11/2022	QUORIS	12	KIA MOTORS CORPORATION	12, Heolleung-ro, Seocho-gu , Seoul, COREA DEL SUR	201
439156	01/11/2022	VICTORIA'S SECRET	3, 4, 21, 22, 24, 25, 26 y 35	VICTORIA'S SECRET STORES BRAND MANAGEMENT, INC.	Four Limited Parkway, 43068, Reynoldsburg, Ohio , E. U. DE NORTEAMERICA	212
441582	15/11/2022	OPEN ENGLISH	41	OPEN ENGLISH LLC	Edif. Torres de las Americas, Torre " A" Piso 15, Punta Pacifica, 0832-0588, Panamá, PANAMA	144
441835	04/11/2022	LIEBERT ICOM	9	LIEBERT CORPORATION	1050 Dearborn drive, 43085, Columbus, Ohio, E. U. DE NORTEAMERICA	194
442375	03/11/2022	VSX SPORT	18, 25 y 35	VICTORIA'S SECRET STORES BRAND MANAGEMENT, INC.	Four Limited Parkway, 43068, Reynoldsburg, Ohio , E. U. DE NORTEAMERICA	212
443083	09/11/2022	BASQUET TIME OUT	41	THE DIRECTV GROUP, INC.	2230 E. Imperial Highway, 90245, El Segundo , California, E. U. DE NORTEAMERICA	218
443806	25/10/2022		30, 35 y 43	STARBUCKS CORPORATION D/B/A STARBUCKS COFFEE COMPANY	2401 Utah Avenue South, 98134, Seattle, Washington, E. U. DE NORTEAMERICA	212
444042	01/11/2022		25	VICTORIA'S SECRET STORES BRAND MANAGEMENT, INC.	Four Limited Parkway, Reynoldsburg, Ohio, E. U. DE NORTEAMERICA	212
444462	25/10/2022	HOLLYWOOD	34	SOUZA CRUZ S.A.	Rua da Candelária, 66 Centro, Centro, Rio de Janeiro, RJ,	194

N° Exp.	Resolución	Denominación	Clases	Titular	Dirección	Ag.
					BRASIL	
444572	03/03/2022	DOLFIN-EFA	5	ANTIA MOLL Y CIA. S.A.	Estero Bellaco 2782, Montevideo, Montevideo, URUGUAY	201
445201	01/11/2022	BODY BY VICTORIA	3 y 25	VICTORIA'S SECRET STORES BRAND MANAGEMENT, INC.	Four Limited Parkway, Reynoldsburg, Ohio, E. U. DE NORTEAMERICA	212
446814	01/11/2022	LOVE PINK	3, 9, 14, 18 y 35	VICTORIA'S SECRET STORES BRAND MANAGEMENT, INC.	Four Limited Parkway, Reynoldsburg, Ohio, E. U. DE NORTEAMERICA	212
447054	01/11/2022	VICTORIA'S SECRET	16, 18 y 35	VICTORIA'S SECRET STORES BRAND MANAGEMENT, INC.	Four Limited Parway East, 43068, Reynoldsburg, Ohio, E. U. DE NORTEAMERICA	212
447226	10/11/2022	COPA EUROAMERICANA DIRECTV	38 y 41	THE DIRECTV GROUP, INC.	2230 E. Imperial Highway, 90245, El Segundo , California, E. U. DE NORTEAMERICA	218
447319	10/11/2022	DIRECT SPORTS +	38 y 41	THE DIRECTV GROUP, INC.	2230 E. Imperial Highway, 90245, El Segundo , California, E. U. DE NORTEAMERICA	218
447919	01/11/2022		3	VICTORIA'S SECRET STORES BRAND MANAGEMENT, INC.	Four Limited Parway East, 43068, Reynoldsburg, Ohio, E. U. DE NORTEAMERICA	144
448457	08/11/2022	AURELIA	4	TOTAL SE	2, place Jean Millier, La Défense 6,, 92400, Courbevoie, FRANCIA	201
448736	10/11/2022	NULGRASS	5	ROEMMERS S. A.	Camino Maldonado 5634, Montevideo, Montevideo, URUGUAY	144
450964	25/10/2022	ETHOS	32	STARBUCKS CORPORATION D/B/A STARBUCKS COFFEE COMPANY	2401 Utah Avenue South, 98134, Seattle, Washington, E. U. DE NORTEAMERICA	212
452798	30/09/2022	DAYLONG	3	Galderma Holding S.A.	Zählerweg 10, 6300, ZUG, SUIZA	245

N° Exp.	Resolución	Denominación	Clases	Titular	Dirección	Ag.
454846	17/10/2022	ROTHSCHILD	36	ROBRIP II AG	Baarerstrasse 95, 6300, Zug, SUIZA	194
458496	01/11/2022		16 y 35	VICTORIA'S SECRET STORES BRAND MANAGEMENT, INC.	Four Limited Parkway, Reynoldsburg, Ohio, E. U. DE NORTEAMERICA	212
459541	03/11/2022	NEUMOTEX BRONQUIAL FORTE	5	LABORATORIOS PHOENIX S.A.I.C. Y F.	Maipu 1300, Piso 11, 1006ACT, Buenos Aires, ARGENTINA	34
459856	07/11/2022	PYLOPASS	1 y 5	ORGANOBALANCE	GUSTAV-MEYER-ALLE 25, 13355, BERLIN, ALEMANIA	181
460469	21/10/2022	DK	35	MONSANTO ARGENTINA S.A.I.C.	Maipú 1210, 6° piso, Buenos Aires, Buenos Aires, ARGENTINA	194
461697	18/10/2022	THE HOME DEPOT	35 y 42	Homer TLC, Inc.	2455 Paces Ferry Road, NW, 30339, Atlanta, Georgia, E. U. DE NORTEAMERICA	194
461881	09/11/2022	DEBATE FÚTBOL DIRECTV SPORTS	38 y 41	THE DIRECTV GROUP, INC.	2240 East Imperial Hwy., 90245, El Segundo, California, E. U. DE NORTEAMERICA	218
462331	04/11/2022	ACTINI-K	3	GALDERMA S.A.	Avenue Gratta-Paille 2, 1018, Lasuane, SUIZA	245
463609	25/10/2022	HOLLYWOOD ORIGINAL ROLL	34	SOUZA CRUZ S.A.	Rua da Candelária, 66, Centro, Rio de Janeiro, Rio de Janeiro, BRASIL	194
464056	25/10/2022	FREE ITASTE 3.0 F FREE	34	SOUZA CRUZ S.A.	Rua Candelaria, 66, Rio de Janeiro, Rio de Janeiro, BRASIL	194
464987	27/10/2022	MINIMA MEDLEY	5	Medley Comercial e Logistica Ltda.	Rua Macedo Costa 55, Jardim Santa Genebra , 13080-180, Campinas, Sao Paulo, BRASIL	165
464987	24/10/2022	MINIMA MEDLEY	5	MEDLEY SA INDUSTRIA FARMACEUTICA	Rua Macedo Costa 55, Jardim Santa Genebra , 13080-180, Campinas, Sao Paulo, BRASIL	165
465829	03/10/2022	PSYCHO BUNNY	25	Psycho Bunny Inc.	5001-5003 rue Levy/5001-5003 Levy Street, H4R2N9, St. Laurent, Quebec, CANADA	194

N° Exp.	Resolución	Denominación	Clases	Titular	Dirección	Ag.
465830	04/10/2022		25	Psycho Bunny Inc.	5001-5003 Levy Street, H4R2N9, St. Laurent, Quebec, CANADA	194
466748	24/10/2022	SOUTH CAPITAL PARTNERS SCP	35	REILMAR S.A.	Av. Rivera 6329 Of 105, Montevideo, URUGUAY	34
466749	24/10/2022	SC SOUTH CAPITAL PARTNERS	35	REILMAR S.A.	Av. Rivera 6329 Of 105, Montevideo, URUGUAY	34
468210	29/09/2020	GALLO	30	MOLINOS IP S.A.U.	Route Du Simplon 16, Case Postale 29, 1049, Paudex, Paudex, SUIZA	34
468825	07/11/2022	KASA	31	K+S KALI GmbH	Bertha-von-Suttner-Strasse 7, 34131, Kassel, ALEMANIA	165
475047	07/11/2022	CMS	1	K+S KALI GmbH	Bertha-von-Suttner-Strasse 7, 34131, Kassel, ALEMANIA	165
475203	13/10/2022	BIOPHILIA	1, 5, 31 y 44	BIOTOP	83 Avenue de la Grande Armée, 75116, Paris, FRANCIA	
475203	14/10/2022	BIOPHILIA	1, 5, 31 y 44	BIOLINE FRANCE	83 Avenue de la Grande Armée, 75116, Paris, FRANCIA	
483219	17/10/2022	LUMAX	6 y 28	CINAMON SOCIEDAD de RESPONSABILIDAD LIMITADA	SORIANO 932, MONTEVIDEO, URUGUAY	189
484335	10/11/2022	DE-NE-NES	3	LABORATORIOS GENESSE, S.L.	AV. CARRILET, 293-297, L'HOSPITALET DE LLOBREGAT, 08907, BARCELONA, ESPAÑA	220
484655	09/11/2022	DIRECTV + PLUS	41	THE DIRECTV GROUP, INC.	2230 East Imperial Hwy, 90245, El Segundo, California, E. U. DE NORTEAMERICA	218
486001	17/05/2022	BRANCA F.LLI BRANCA MILANO CASA FONDATA NEL 1845 -FERNET- BRANCA FRATELLI BRANCA DISTILLERIE	33	Fratelli Branca Distillerie S.p.A.	Via Broletto 35, 20121, Milán, ITALIA	144

N° Exp.	Resolución	Denominación	Clases	Titular	Dirección	Ag.
486860	08/11/2022	SERIOLA	4	TOTAL SE	2 Place Jean Millier, 92400, La Defense 6, Courbevoie, FRANCIA	201
489042	19/10/2022	RED KAP	25	Imagewear Apparel Corp.	3411 Silverside Road, 19810, Wilmington, Delaware, E. U. DE NORTEAMERICA	245
489043	19/10/2022	RED KAP 1923	25	Imagewear Apparel Corp.	3411 Silverside Road, 19810, Wilmington, Delaware, E. U. DE NORTEAMERICA	245
495221	30/09/2022	CARDIOXANE	5	Clinigen Limited	Pitcairn House, Crown Square, Centrum 100, DE14 2WW, Burton-On-Trent, Staffordshire, GRAN BRETAÑA (REINO UNIDO)	201
498574	08/11/2022	PAE PAN AMERICAN ENERGY	4, 37, 39, 40 y 42	PAN AMERICAN ENERGY LLC	Arbea Campus Empresarial, Edificio 1, Ctra. Fuencarral a Alcobendas, M603, 3,8 Km Alcobendas, Madrid, 28108, -, MADRID, ESPAÑA	94
498983	07/11/2022	SIVBEV	5	Agensys, Inc. y Seattle Genetics, Inc.	1800 Stewart Street, Santa Monica, 90404, California, California, E. U. DE NORTEAMERICA y 21823 30th Drive S.E., Bothell, 98021, Washington, Washington, E. U. DE NORTEAMERICA	245
498984	07/11/2022	PADCEV	5	Agensys, Inc. y Seattle Genetics, Inc.	1 Astellas Way, Northbrook, 60062, ILLINOIS, E. U. DE NORTEAMERICA y 21823 30th Drive S.E., Bothell, 98021, Washington, Washington, E. U. DE NORTEAMERICA	245
498987	07/11/2022	EVBRYTO	5	Agensys, Inc. y Seattle Genetics, Inc.	1800 Stewart Street, Santa Monica, 90404, California,	245

N° Exp.	Resolución	Denominación	Clases	Titular	Dirección	Ag.
					California, E. U. DE NORTEAMERICA y 21823 30th Drive S.E., Bothell, 98021, Washington, Washington, E. U. DE NORTEAMERICA	
499258	09/11/2022	D' AUCY	29	COMPAGNIE GENERAL DE CONSERVES (Una corporación francesa)	Kerlurec THEIX-NOYALO , 56450, FRANCIA	245
500674	07/11/2022		9, 35, 36, 38, 42 y 45	WhatsApp Inc.	1601 Willow Road, Menlo Park, California, 94025, -, -, E. U. DE NORTEAMERICA	194
513226	04/10/2022	LASSO	9, 38, 42 y 45	Meta Platforms, Inc.	1601 Willow Road, CA 94025, Menlo Park, Menlo Park, E. U. DE NORTEAMERICA	194
519305	12/10/2022		7	Mercedes-Benz Group AG.	Mercedesstraße 120, 70372 , Stuttgart, ALEMANIA	34
519861	26/10/2022	ENERFOS	5 y 31	NORTESUR LTDA.	Ruta 8 Brig. Gral. Juan A. Lavalleja 7407/09, Montevideo, Montevideo, Montevideo, URUGUAY	144
529701	04/11/2022	KIA ECO DYNAMICS	12	KIA MOTORS CORPORATION	12, Heolleung-ro, Seocho-gu , Seoul, COREA DEL SUR	201
530374	10/11/2022	LACTOVIT	3	LABORATORIOS GENESSE, S.L.	AV. CARRILET, 293-297, L'HOSPITALET DE LLOBREGAT, 08907, BARCELONA,, BARCELONA,, ESPAÑA	220
531140	10/11/2022	KINESIA	3 y 5	LABORATORIOS GENESSE, S.L.	AV. CARRILET, 293-297, L'HOSPITALET DE LLOBREGAT, 08907, BARCELONA, BARCELONA, ESPAÑA	220

CAMBIOS DE NOMBRE DESESTIMADOS (Art. 92, D. 34/999)

N° Exp.	Resolución	Denominación	Clases	Titular	Dirección	Ag.
383052	24/10/2022	MEXSANA	5	MSD Consumer Care, Inc.	3030 Jackson Avenue, 38151, Memphis, Tennessee, E. U. DE NORTEAMERICA	218
393983	17/10/2022	DON GATO RESTO.BAR	43	HUGO ANLÓ CHUDELI	Antonio Machado 1588, Montevideo, Montevideo, URUGUAY	
504649	27/10/2022	FUNDACION RALLI	41	VIRGINIA SERRANA PRUNELL FALGUERAS	LOS ARRAYANES ESQ. PITANGAS, 20100, Punta del Este, Maldonado, URUGUAY	
520415	05/10/2022	GRACIAS NEGRITO	1, 2, 3, 4, 5, 6, 7, 8, 9, 10, 11, 12, 13, 14, 15, 16, 17, 18, 19, 20, 21, 22, 23, 24, 25, 26, 27, 28, 29, 30, 31, 32, 33, 34, 35, 36, 37, 38, 39, 40, 41, 42, 43, 44 y 45	Pablo Fernández Gómez	Senaqué 3628, Montevideo, 11700, Montevideo, Montevideo, URUGUAY	

CAMBIOS DE NOMBRE DE PATENTES

N° Exp.	Resolución	Titular	Dirección	Ag.
034878	18/11/2022	DOW AGROSCIENCES LLC		211
034930	04/11/2022	DOW AGROSCIENCES LLC		211
035060	14/10/2022	Dow AgroSciences LLC		211
035228	17/10/2022	DOW AGROSCIENCES LLC		20
035247	04/10/2022	Corteva Agriscience LLC.		211
035380	17/10/2022	DOW AGROSCIENCES LLC		20
035434	20/10/2022	DOW AGROSCIENCES LLC		20
035473	25/10/2022	DOW AGROSCIENCES LLC		20
035892	20/10/2022	DOW AGROSCIENCES LLC		20
035893	20/10/2022	DOW AGROSCIENCES LLC		20
036159	21/10/2022	DOW AGROSCIENCES LLC		216
036163	18/11/2022	DOW AGROSCIENCES LLC		216
036164	21/11/2022	DOW AGROSCIENCES LLC		216

N° Exp.	Resolución	Titular	Dirección	Ag.
036165	21/11/2022	DOW AGROSCIENCES LLC		216
036892	04/10/2022	Corteva Agriscience LLC.		211
036895	04/10/2022	Corteva Agriscience LLC,		20
036896	04/10/2022	Corteva Agriscience LLC,		20
036916	04/10/2022	LOGSENT S.A.S		216
037231	25/10/2022	CALICO LIFE SCIENCES, LLC. y AbbVie Inc.		216
037919	21/11/2022	RECEPTOR LIFE SCIENCES, INC.		216

CAMBIOS DE DOMICILIO

N° Exp.	Resolución	Denominación	Clases	Titular	Dirección	Ag.
354377	17/10/2022	LINDA BOTICARIO	3	BOTICA COMERCIAL FARMACÉUTICA LTDA.	Av. Rui Barbosa No.4110, del BARRIO PARQUE DA FONTE , 83.050-010, CIUDAD DE SAO JOSE DOS PINHAIS, PR, BRASIL	144
357668	17/10/2022	ZULU	1 y 3	COMPANHIA NACIONAL DE ALCOOL	ALAMEDA MADEIRA 222 - 7° ANDAR, CONJUNTO 71, MUNICIPIO DE BARUERI , São Paulo, BRASIL	101
365884	31/10/2022	H & M	25 y 35	H & M HENNES & MAURITZ AB	SE-106 38, STOCKHOLM, SUECIA	
366756	20/10/2022	VIRTUOSO LIFE	16	VIRTUOSO, LTD.	777 MAIN STREET, SUITE 900, 76102, Fort Worth, Texas, E. U. DE NORTEAMERICA	20
368565	17/10/2022	KIR28	5	ZODIAC INTERNATIONAL CORPORATION	CALLE 50, TORRE GLOBAL PLAZA 6° PISO, PANAMA, PANAMA	6
369223	17/10/2022	TOLMUS	5	ZODIAC INTERNATIONAL CORPORATION	Calle 50, Torre Global Plaza 6° Piso, Panamá, PANAMA	6
371193	13/10/2022	CRUSH	32	ATLANTIC INDUSTRIES	P.O. Box 309, Uglan House, South Church Street George Town, KY1-1104, Grand	144

N° Exp.	Resolución	Denominación	Clases	Titular	Dirección	Ag.
					Cayman, ISLAS CAIMAN	
374137	03/11/2022	CAPRI	30	COMPAÑIA OLEAGINOSA URUGUAYA S.A.	LUIS BATLLE BERRES 5327, Montevideo, Montevideo, URUGUAY	144
375504	01/11/2022	OKTOBERFEST	41	DEUTSCHER RUDERVEREIN MONTEVIDEO/CLUB ALEMAN DE REMO MONTEVIDEO	Riachuelo 171, montevideo, uruguay, URUGUAY	186
377453	11/11/2022	ZONA JOBS	16, 35 y 38	Intellectual Assets LLC.	251 Little Falls Drive Wilmington, 19808 , New Castle County, Delaware, E. U. DE NORTEAMERICA	181
377562	18/10/2022	NORTE	34	ABAL HNOS. S.A.	Gabriel Otero 6462 of. 101, Montevideo, Montevideo, URUGUAY	40
377671	17/10/2022	O. BOTICARIO	3	BOTICA COMERCIAL FARMACEUTICA LTDA.	Av. Rui Barbosa, 4110 DEL BARRIO PARQUE DA FONTE , 83050-010, Sao Jose Dos Pinhais, Parana, BRASIL	3
380105	20/10/2022	MISTRAL	9, 18, 22, 25 y 28	Mistral International B.V.	Industrieweg 4A, 7641 AT, WIERDEN, PAISES BAJOS	182
382678	25/10/2022	METSO	7, 9, 11, 17, 37 y 42	METSO CORPORATION	Töölönlahdenkatu 2, 00100, Helsinki, FINLANDIA	18
383497	18/10/2022	VIDA	29	SOLDO HNOS. S.A.	José Batlle y Ordoñez 6781, Montevideo, Montevideo, URUGUAY	144
383534	26/10/2022	KING GEORGE V	33	DIAGEO BRANDS B.V.	Molenwerf 12, 1014 BG, Amsterdam, PAISES BAJOS	212
384005	25/10/2022	FINCA SPG	33	FINCA SPG S.A.	PLAZA CAGANCHA 1145 PISO 6, Montevideo, Montevideo, URUGUAY	
388953	14/10/2022	SR SAN ROQUE	42, 43, 44 y 45	SAN ROQUE S.A.	Bulevar Artigas 1913, Montevideo, Montevideo,	34

N° Exp.	Resolución	Denominación	Clases	Titular	Dirección	Ag.
					URUGUAY	
388954	14/10/2022	SR SAN ROQUE	40	SAN ROQUE S.A.	Bulevar Artigas 1913, Montevideo, Montevideo, URUGUAY	34
390417	17/10/2022	TARJETA LINDA SAN ROQUE	16 y 36	SAN ROQUE S.A.	Bulevar Artigas 1913, Montevideo, Montevideo, URUGUAY	34
391098	21/10/2022	ZONATECNO WWW.ZONATECNO.COM. UY	35	GONZALO MACEDO ZAS	Juncal 1401, MONTEVIDEO, URUGUAY	94
393599	26/10/2022	SANDY MAC	33	DIAGEO BRANDS B.V.	Molenwerf 12, 1014 BG, Amsterdam, PAISES BAJOS	212
395554	07/11/2022	BARRY CALLEBAUT	30	BARRY CALLEBAUT AG	Hardturmstrasse 181, 8005, Zurich, SUIZA	94
396128	07/11/2022	OVACIÓN	16	EL PAIS S.A.	Zelmar Michellini 1283, MONTevideo, URUGUAY	245
396364	07/11/2022	LANDI RENZO	7 y 9	LANDI RENZO S.P.A.	Via Nobel 2/4, 42025 , CAVRIAGO (RE), ITALIA	34
396424	03/11/2022		9	VIEWSONIC CORPORATION	10 Pointe Drive , Suite 200, 235, 255, 92821, BREA, California, E. U. DE NORTEAMERICA	212
396428	04/11/2022	ARKANO SOFTWARE	42	ARKANOSOFT S.A.	Paseo Pasaje de las Carretas 2580, Montevideo, URUGUAY	
398277	01/11/2022	CALTRATE	5	WYETH HOLDINGS LLC	235 East 42nd Street, 10017, New York , New York , E. U. DE NORTEAMERICA	194
398278	01/11/2022	CENTRUM	5	WYETH HOLDINGS LLC	235 East 42nd Street, 10017, New York , New York, E. U. DE NORTEAMERICA	194
399003	03/11/2022	STRAUCH	5	LA BUENA ESTRELLA S.A.	RUTA 101 KM. 24.500 ESQ. CAMINO DE LOS PORTUGUESES, CANELONES , URUGUAY	152
399737	14/11/2022	GKSPEED	9	RADIO FREQUENCY	rue Baptiste Marcet – , 44570 ,	192

N° Exp.	Resolución	Denominación	Clases	Titular	Dirección	Ag.
				SYSTEMS FRANCE	TRIGNAC, FRANCIA	
401665	09/11/2022	BALL PARK	29	SARA LEE FOODS, LLC	400 South Jefferson St. , 60607, CHICAGO, Illinois, E. U. DE NORTEAMERICA	136
401794	22/11/2022	SERGIO TACCHINI	18	SERGIO TACCHINI INTERNATIONAL S.P.A. S.r.L.	Galleria Sala dei Longobardi 2, 20121, MILANO, ITALIA	165
401848	25/10/2022	IREKS	30 y 31	IREKS GMBH	Lichtenfelser Str. 20 , 95326, Kulmbach , ALEMANIA	34
402730	04/11/2022	SKINCO2DE	3	SKINCODE AG	Seestrasse 59, 8703, Erlenbach, Switzerland, SUIZA	165
402776	07/11/2022	BOTTO GIUSEPPE	24	BOTTO GIUSEPPE & FIGLI S.P.A.	Via B.Sella 166, 13835, Valdilana, Biella, ITALIA	212
403287	09/11/2022	DUCIEL	20 y 24	LAMITEX S.A.	Camino Repetto 4648, Montevideo, Montevideo, Montevideo, URUGUAY	
405359	18/11/2022	IMUSA	21	GROUPE SEB ANDEAN S.A.	KM 40 AUTOPISTA MEDELLIN-BOGOTA, VEREDA GALICIA, Rionegro, Antioquia, COLOMBIA	34
406659	11/11/2022	PANDA SECURITY	9, 42 y 45	PANDA SECURITY, S.L.	Calle Santiago de Compostela 12, 1ª, 48003, Bilbao , Bizkaia, ESPAÑA	34
407432	11/11/2022	SERVICE COURSE	12	SRAM, LLC	1000 W. Fulton Market, 4th floor, 60607, Chicago, Illinois , E. U. DE NORTEAMERICA	136
407462	15/11/2022	HAAS	31	ALGORTA S.A.	Callao 3364 , Montevideo, URUGUAY	245
407506	30/09/2022	DERMOTIVIN	3 y 5	Galderma Holding S.A.	Zählerweg 10, 6300, ZUG, SUIZA	245
407921	21/10/2022	ZONATECNO	35	GONZALO MACEDO	JUNCAL 1401, MONTEVIDEO, URUGUAY	94
408779	21/10/2022	FLEXITOL	3 y 5	LADERMA HOLDINGS PTY LIMITED	Tower 2, L14, 101 Grafton St, 2922, Bondi Junction, NSW,	34

N° Exp.	Resolución	Denominación	Clases	Titular	Dirección	Ag.
					AUSTRALIA	
408981	08/11/2022	TOP TECNOLOGÍA OSMOPROTECTORA	1	RIZOBACTER ARGENTINA S.A.	Avda. Dr. Arturo Frondizi No.1150, Parque Industrial Pergamino , Buenos Aires, ARGENTINA	34
409012	15/11/2022	LURAZIC	5	ZODIAC INTERNATIONAL CORPORATION	Calle 50, Edificio Global Plaza, 6to Piso , PANAMA, PANAMA	245
410831	06/10/2022	DETER & COLAGENO PROTEGE TUS MANOS	3	ELECTROQUIMICA S.A.	Antigua Continuación Colman 5827, Montevideo, URUGUAY	194
411310	20/05/2022	TEATINO	5 y 30	GRUPO OMNILIFE S.A. DE C.V.	Av. Juan Gil Preciado número 2450 int J. Colonia El Tigre, C.P. 45134, Zapopan, Jalisco, MEXICO	212
411903	06/10/2022	CRISTA CATH	10	BIOSENSE WEBSTER, INC.	31 Technology Drive, Suite 200, 92618, Irvine, CA, E. U. DE NORTEAMERICA	194
411904	06/10/2022	NAVI-STAR	10	BIOSENSE WEBSTER, INC.	31 Technology Drive, Suite 200, 92618, Irvine, CA, E. U. DE NORTEAMERICA	194
412021	07/11/2022	ORIENT	14	ORIENT TOKEI KABUSHIKI KAISHA (TAMBIÉN COMERCIANDO COMO ORIENT WATCH CO., LTD.)	1-6, Shinjuku 4-chome, Shinjuku-ku, Tokyo, JAPON	156
412146	13/10/2022	DAROM	3	SAN ROQUE S.A.	Bulevar Artigas 1913, MONTEVIDEO, URUGUAY	34
413073	04/11/2022	ESCORT	12	FORD MOTOR COMPANY LIMITED	Arterial Road, SS15 6EE, LAIDON, Essex, GRAN BRETAÑA (REINO UNIDO)	194
413690	06/10/2022	TALAR	29, 30, 31, 32 y 33	FAROLUR S.A.	Ruta 12 km 10, Maldonado, URUGUAY	19
414190	27/10/2022	HILFIGER DENIM	25	TOMMY HILFIGER	200 Madison Avenue, 10016,	194

N° Exp.	Resolución	Denominación	Clases	Titular	Dirección	Ag.
				LICENSING LLC	NY, New York, E. U. DE NORTEAMERICA	
414191	28/10/2022	TOMMY	25	TOMMY HILFINGER LICENSING, INC.	200 Madison Avenue, 10016, NY, New York, E. U. DE NORTEAMERICA	194
414612	26/10/2022	MEDLEY	5	MEDLEY FARMACEUTICA LTDA.	Rua Macedo Costa 55, Jardim Santa Genebra , CEP 13080-180, Campinas, Sao Paulo, BRASIL	165
414624	11/10/2022	TARJETA VERDE	35 y 36	FINAMERICATI S.R.L.	RIO NEGRO 1354 OFICINA 20, MONTEVIDEO, URUGUAY	
414893	15/11/2022	NEXEN	12	NEXEN TIRE CORPORATION	355, CHUNGNYEOL-RO, YANGSAN-SI,GYEONGSANGNAM-DO , COREA DEL SUR	201
415055	08/11/2022	PEOPLE'S SHOES OF ITALY	25	SUPERGA TRADEMARK S.A.	LARGO MAURIZIO VITALE 1, 10152, TURIN, ITALIA	212
415057	08/11/2022		9, 18 y 25	SUPERGA TRADEMARK S.A.	LARGO MAURIZIO VITALE 1, 10152, TURIN, ITALIA	212
415057	09/11/2022		9, 18 y 25	SUPERGA TRADEMARK S.A.	LARGO MAURIZIO VITALE 1, 10152, TURIN, ITALIA	212
415299	03/10/2022		33	PLAYBOY ENTERPRISES INTERNATIONAL, INC.	10960 Wilshire Boulevard Suite 2200, CA 90024, LOS ANGELES, CALIFORNIA, E. U. DE NORTEAMERICA	201
416011	17/10/2022	DAROM HEALTH & BEAUTY	3, 5 y 44	SAN ROQUE S.A.	Bulevar Artigas 1913,, MONTEVIDEO, URUGUAY	34
416025	03/11/2022	THE BRIDGE	18	THE BRIDGE S.p.A.	Via Codignola 14/16, Scandicci, FLORENCIA, ITALIA	18
416025	21/10/2022	THE BRIDGE	18	IL PONTE S.R.L.	Via Codignola 14/16, Scandicci, FLORENCIA, ITALIA	18
416248	22/11/2022	LEONARD	18 y 25	LEONARD FASHION	31 rue Jean Giraudoux, 75116, Paris, FRANCIA	181
417226	17/10/2022	SR SAN ROQUE	1, 3, 5, 9 y 10	SAN ROQUE S.A.	Bulevar Artigas 1913, Montevideo, Montevideo,	34

N° Exp.	Resolución	Denominación	Clases	Titular	Dirección	Ag.
					URUGUAY	
417310	14/10/2022	SAN ROQUE SR	1, 3, 5, 9, 10 y 44	SAN ROQUE S.A.	Bulevar Artigas 1913, MONTEVIDEO, URUGUAY	34
417311	15/11/2022	SEMI SEGURO DE ENFERMEDAD DE LOS MEDICOS DEL INTERIOR	36 y 44	SEGURO DE ENFERMEDAD DE LOS MEDICOS DEL INTERIOR (SEMI)	MARIO CASSINONI 1696 ESC. 1102, Montevideo, Montevideo, URUGUAY	201
419123	06/10/2022	LUMAX	7, 9 y 11	CINAMON URUGUAY S.A.S.	SORIANO 932, MONTEVIDEO, URUGUAY	189
419574	30/09/2022	CURELIGHT	10	Galderma Holding S.A.	Zählerweg 10, 6300, ZUG, SUIZA	245
419575	04/10/2022	METVIX	5	Galderma Holding S.A.	Zählerweg 10, 6300, ZUG, SUIZA	245
419667	17/10/2022	MOPLEN	1	LYONDELLBASELL INDUSTRIES HOLDINGS B.V.	Delftseplein 27E, 3013 AA , Rotterdam, PAISES BAJOS	144
419812	03/11/2022	ROLODEX	16	BEROL CORPORATION	6655 Peachtree Dunwood Road, 30328, ATLANTA, GEORGIA, E. U. DE NORTEAMERICA	194
421965	09/11/2022	V VAN LEER	5, 29 y 30	BARRY CALLEBAUT AG.	Hardturmstrasse 181, 8005, Zurich, SUIZA	94
421998	05/10/2022	TRI-LUMA	5	Galderma Holding S.A.	Zählerweg 10, 6300, ZUG, SUIZA	245
422541	18/10/2022	CIMARRON	25	MELOPHONE – CONSULTORES E SERVICOS, Ltd.	INTEGRITAS BUSINESS CENTRE, SUITE C OFFICE 11, 114/3, THE STRAND, MALTA	
422622	06/10/2022	208	12	AUTOMOBILES PEUGEOT	2-10 Boulevard de l'Europe, 78300, POISS, FRANCIA	144
422720	04/11/2022	QUALITY COCOA FOR A BETTER LIFE QUALITU PARTNER PROGRAM	29, 30 y 42	BARRY CALLEBAUT AG	Hardturmstrasse 181, 8005, Zurich, SUIZA	94
422937	16/11/2022	FOFURA	29 y 30	PEPSICO DO BRASIL LTDA.	Av. Presidente Juscelino Kubitschek, nº 180, 6º e 7º andares , Vila Nova Conceição,	201

N° Exp.	Resolución	Denominación	Clases	Titular	Dirección	Ag.
					SP (04543-000), São Paulo, BRASIL	
422938	16/11/2022	TORCIDA	29 y 30	PEPSICO DO BRASIL LTDA.	Av. Presidente Juscelino Kubitschek, n° 180, 6° e 7° andares , Vila Nova Conceição, SP (04543-000), São Paulo, BRASIL	201
422980	07/11/2022	CRESTOR	5	IPR PHARMACEUTICALS INC	ROAD 188, – SAN ISIDRO INDUSTRIAL PARK, CANOVANAS, 00729 -, PUERTO RICO	201
423207	15/11/2022		5, 29 y 30	Opella Healthcare Switzerland AG	Suurstoffi 2, 6343 , Rotkreuz, SUIZA	144
423342	04/11/2022	DIDELIN	12, 35 y 37	DIDELIN SOCIEDAD ANONIMA	Batovi 2282, Montevideo, Montevideo, URUGUAY	
423466	08/11/2022	NEEDLE-PRO	10	SMITHS MEDICAL ASD, INC.	6000 NATHAN LANE NORTH, (55442) , MINNEAPOLIS, MINNESOTA , E. U. DE NORTEAMERICA	201
423670	04/11/2022	CHOICE HOTELS	43	CHOICE HOTELS INTERNATIONAL, INC.	1 Choice Hotels Circle , MD 20850, ROCKVILLE, E. U. DE NORTEAMERICA	136
424004	09/11/2022	SICAO	29 y 30	BARRY CALLEBAUT AG	Hardturmstrasse 181, 8005, Zurich, SUIZA	94
424403	17/10/2022		33	SOCIETE JAS HENNESSY & CO.	rue de la Richonne, 16100, Cognac, FRANCIA	40
424414	15/11/2022	SIM - SMILES - INCENTIVE MILES	39	GOL LINHAS AÉREAS S.A.	Praça Senador Salgado Filho, s/n°, Aeroporto, Santos Dumont, térreo, área pública, entre os eixos 46-48/O-P, Sala da Gerência Back Office, Rio de Janeiro, BRASIL	201
424906	08/11/2022	DAYCO	7	DAYCO IP HOLDINGS, LLC.	1650 Research Drive, Suite 200, Troy, 48083, MICHIGAN, E. U.	245

N° Exp.	Resolución	Denominación	Clases	Titular	Dirección	Ag.
					DE NORTEAMERICA	
425195	27/10/2022	TOMMY HILFIGER	25	TOMMY HILFIGER LICENSING LLC	200 Madison Avenue, 10016, NY, New York, E. U. DE NORTEAMERICA	194
426313	08/11/2022	NOVATECK	12 y 17	PIRELLI TYRE S.P.A.	VIALE PIERO E ALBERTO PIRELLI 25, 20126, MILAN , ITALIA	34
426384	08/11/2022	AIRLOCK	9	MARCHON EYEWEAR, INC.	201 Old Country Road, third floor, 11747, Melville, New York, E. U. DE NORTEAMERICA	136
426417	10/11/2022	PENEDO	20, 21 y 30	SEB DO BRASIL PRODUTOS DOMESTICOS LTDA.	Av. Arno, n° 146, parte Mooca , 031800-900, São Paulo, BRASIL	34
426570	21/10/2022	POWER XPERT UX	9	EATON CORPORATION	1000 Eaton Boulevard, 44122, Cleveland, Ohio, E. U. DE NORTEAMERICA	94
426612	19/10/2022	TYREPLUS	12, 16, 35, 37, 41 y 42	COMPAGNIE GENERALE DES ETABLISSEMENTS MICHELIN	23, Place des Carmes-Déchaux, 63000, CLERMONT- FERRAND, FRANCIA	201
426613	19/10/2022	TYRE PLUS	12, 16, 35, 37, 41 y 42	COMPAGNIE GENERALE DES ETABLISSEMENTS MICHELIN	23, Place des Carmes-Déchaux, 63000, CLERMONT- FERRAND, FRANCIA	201
426622	08/11/2022	BRITANNICA	9 y 42	ENCYCLOPAEDIA BRITANNICA, INC.	325 North LaSalle Street Suite 200, 60654, Chicago, Illinois, E. U. DE NORTEAMERICA	194
427052	24/10/2022	PIGEON	7	ZHENGYANG INVESTMENT CO., LTD.	No.558 Greatwall East Road, Economic Development Zone, Yongkang, JINHUA , ZHEJIANG, CHINA	144
427345	15/06/2022	CLARINS	3	CLARINS	9 rue du Commandant Pilot, 92200, NEUILLY SUR SEINE,	245

N° Exp.	Resolución	Denominación	Clases	Titular	Dirección	Ag.
					FRANCIA	
427465	08/11/2022	NUTRITERNERA	31	BARRACA JORGE WALTER ERRO S.A.	PERIMETRAL JUAN MANUEL BLANES Y CARLOS MARIA RUIZ, DOLORES, SORIANO, URUGUAY	34
427991	17/10/2022	LEVABON	5 y 31	BIOMIN HOLDING GMBH	ERBER CAMPUS 1, 3131, GETZERSDORF BEI TRAISMAUER, AUSTRIA	201
428537	28/10/2022		25	TOMMY HILFIGER LICENSING LLC	200 Madison Avenue, 10016, NY, New York, E. U. DE NORTEAMERICA	194
428712	25/10/2022	MYCOSORB	31	ALLTECH INC.	3031 Catnip Hill Road, (40356), Nicholasville, Kentucky , E. U. DE NORTEAMERICA	201
428795	08/11/2022	KELLER	31	LODYTEX S.A.	PERIMETRAL JUAN MANUEL BLANES Y CARLOS M. RUIZ, DOLORES, SORIANO, URUGUAY	34
428796	08/11/2022	CRIANZAS CASERAS	31	LODYTEX S.A.	PERIMETRAL JUAN MANUEL BLANES Y CARLOS M. RUIZ, DOLORES, SORIANO, URUGUAY	34
428958	27/10/2022		14	TOMMY HILFIGER LICENSING LLC	200 Madison Avenue, 10016, NY, New York, E. U. DE NORTEAMERICA	194
428960	05/10/2022	VASTREKA	5	Galderma Holding S.A.	Zählerweg 10, 6300, ZUG, SUIZA	245
428961	05/10/2022	MIRVASO	5	Galderma Holding S.A.	Zählerweg 10, 6300, ZUG, SUIZA	245
429018	05/10/2022	ONREALTEA	5	Galderma Holding S.A.	Zählerweg 10, 6300, ZUG, SUIZA	245
429022	30/09/2022	ELVAYA	5	Galderma Holding S.A.	Zählerweg 10, 6300, ZUG, SUIZA	245
429023	05/10/2022	SELSTREKA	5	Galderma Holding S.A.	Zählerweg 10, 6300, ZUG, SUIZA	245

N° Exp.	Resolución	Denominación	Clases	Titular	Dirección	Ag.
					SUIZA	
429062	15/11/2022	DOXOPEG	5	ZODIAC INTERNATIONAL CO.	Calle 50, Edificio Global Plaza, 6to Piso , PANAMA, PANAMA	245
429063	15/11/2022	INMUNOPRIN	5	ZODIAC INTERNATIONAL CO.	Calle 50, Edificio Global Plaza, 6to Piso , PANAMA, PANAMA	245
429067	15/11/2022		5	NOLVER S.A.	Leonel Aguirre 1881 , MONTEVIDEO, URUGUAY	245
429068	15/11/2022		1, 3, 10 y 21	NOLVER S.A.	Leonel Aguirre 1881 , MONTEVIDEO, URUGUAY	245
429070	15/11/2022	RIVIANA	30	RIVIANA FOODS INC.	2777 Allen Parkway, 77019, Houston, Texas, E. U. DE NORTEAMERICA	216
429352	01/11/2022	CIPRIANI	43 y 44	ALTUNIS - TRADING, GESTÃO E SERVIÇOS, SOCIEDADE UNIPessoal, LDA.	Avenida Arriaga, Número 73, 1 Andar, Sala 113, 9000-060, Funchal, Madeira, PORTUGAL	212
429684	05/10/2022	ONRELTEA	5	Galderma Holding S.A.	Zählerweg 10, 6300, ZUG, SUIZA	245
430300	09/11/2022	VIAAQUA SPA	41, 43 y 44	MONT GROUP S.A.	Victor Soliño 375 , Montevideo, Montevideo, URUGUAY	245
430416	30/09/2022	ERYACNE	5	Galderma Holding S.A.	Zählerweg 10, 6300, ZUG, SUIZA	245
430417	30/09/2022	DIFFERINE	5	Galderma Holding S.A.	Zählerweg 10, 6300, ZUG, SUIZA	245
430529	04/10/2022	TALIXANE	5	Galderma Holding S.A.	Zählerweg 10, 6300, ZUG, SUIZA	245
430554	10/11/2022	HC	19	Holcim AG	Grafenauweg 10, 6300, zug, SUIZA	192
430639	04/10/2022	PROVIRTUA	35	Galderma Holding S.A.	Zählerweg 10, 6300, ZUG, SUIZA	245
430998	10/11/2022		5	Opella Healthcare Switzerland AG	Suurstoffi 2, 6343, Rotkreuz, SUIZA	144
431131	15/11/2022	J.CREW	18 y 25	J. CREW INTERNATIONAL,	225 Liberty Street, 17th Floor, 10281, New York, New York, E.	194

N° Exp.	Resolución	Denominación	Clases	Titular	Dirección	Ag.
				INC.	U. DE NORTEAMERICA	
431201	15/11/2022	MITEL	7, 9, 11, 14 y 17	MITEL NETWORKS CORPORATION	4000 Innovation Drive, K2K3K1, Kanata, ON, CANADA	216
431487	06/10/2022	GRUPO SANTANDER	16, 35, 36 y 38	SANTANDER INVESTMENT BANK LIMITED	Caves Corporate Centre, Building A, 1st Floor, West Bay Street & Blake Road, P.O.Box N-1682, Nassau, BAHAMAS	194
432296	01/11/2022	PARAMOUNT	23	PARAMOUNT TEXTEIS INDUSTRIA E COMERCIO S.A.	Av. Eusebio Matoso, 1375 - 3º andar, Butantã, , São Paulo, Estado de São Paulo, BRASIL	34
432763	04/11/2022	PALL MALL	34	BRITISH AMERICAN TOBACCO (BRANDS) INC.	251 Little Falls Drive, Suite 100 , 19808-1674, Wilmington, DE, E. U. DE NORTEAMERICA	194
433097	16/11/2022	PEUGEOT 307 SW	12	AUTOMOBILES PEUGEOT	2 – 10 Boulevard de l'Europe, POISSY, 78300 , FRANCIA	144
433098	16/11/2022	PEUGEOT 206 SW	12	AUTOMOBILES PEUGEOT	2 – 10 Boulevard de l'Europe, POISSY, 78300 , FRANCIA	144
433147	14/11/2022	VALLEY FARMS	29 y 30	MCCAIN FOODS LIMITED	8800 Main St. Florenceville-Bristol, E7L 1B2, New Brunswick, CANADA	94
433456	09/11/2022	GATO NEGRO	33	VIÑA SAN PEDRO TARAPACÁ S.A.	Av. Vitacura 2670 Piso 16, LAS CONDES, SANTIAGO DE CHILE, CHILE	181
434646	08/11/2022	YANMAR	12	YANMAR CO. LTD.	1-32 CHAYAMACHI, Kyta-Ku, Osaka, JAPON	156
434789	17/10/2022	DIAMANT	35 y 36	SAN ROQUE S.A.	Bulevar Artigas 1913,, Montevideo, Montevideo, URUGUAY	34
434827	27/10/2022		25	TOMMY HILFIGER LICENSING LLC	200 Madison Avenue, 10016, NY, New York, E. U. DE NORTEAMERICA	194
435576	06/10/2022	FOREVER FRIENDS	16	HALLMARK CARDS PLC	Dawson Lane, Dudley Hill, Bradford, BD4 6HN, Bradford,	192

N° Exp.	Resolución	Denominación	Clases	Titular	Dirección	Ag.
					West Yorkshire, GRAN BRETAÑA (REINO UNIDO)	
435781	30/09/2022	ZODIAC	7 y 12	Z Nautic	11 Chemin de Rainneville, 74940, Annecy- Le- Vieux, FRANCIA	34
435781	20/10/2022	ZODIAC	7 y 12	Z Nautic	11 Chemin de Rainneville, 74940, Annecy- Le- Vieux, FRANCIA	34
436095	30/09/2022	INNEOV	3, 5, 29 y 30	Galderma Holding S.A.	Zählerweg 10, 6300, ZUG, SUIZA	245
436374	18/10/2022	RON FLOR DE CAÑA GOLD	33	COMPAÑÍA LICORERA DE CENTROAMERICA, S.A.	Plaza Scotia, Piso 11, Ave. Federico Boyd y Calle 51, Panamá, PANAMA	94
437084	18/10/2022	TABCIN	5	BAYER HEALTHCARE LLC	100 Bayer Boulevard, 07981, Whippany, New Jersey, E. U. DE NORTEAMERICA	205
437274	04/11/2022	CALLEBAUT	29	BARRY CALLEBAUT AG.	Hardturmstrasse 181, 8005, Zurich, SUIZA	94
437275	04/11/2022	CACAO BARRY	29	BARRY CALLEBAUT AG.	Hardturmstrasse 181, 8005, Zurich, SUIZA	94
437309	07/10/2022	AVENT	11 y 18	AVENT LIMITED	Ascent 1 Aerospace Boulevard, GU14 6XW, Farnborough, GRAN BRETAÑA (REINO UNIDO)	34
437476	05/10/2022	RETACNYL	5	Galderma Holding S.A.	Zählerweg 10, 6300, ZUG, SUIZA	245
437629	04/11/2022	ABAL	1, 2, 4, 6, 7, 8, 9, 10, 11, 12, 13, 14, 15, 16, 17, 18, 19, 20, 21, 22, 23, 24, 25, 26, 27, 28, 29, 30, 31, 32, 33, 34, 35, 36, 37, 38, 39, 40, 41, 42, 43, 44 y 45	ABAL HERMANOS S.A.	Gabriel Otero 6462 of 105, 11500, Montevideo, URUGUAY	201
437723	10/11/2022		5	Opella Healthcare	Suurstoffi 2, 6343, Rotkreuz,	144

N° Exp.	Resolución	Denominación	Clases	Titular	Dirección	Ag.
				Switzerland AG	SUIZA	
437973	11/11/2022	QUORIS	12	KIA CORPORATION	12, Heolleung-ro, Seocho-gu , Seoul, COREA DEL SUR	201
438256	04/11/2022	CONCERTA	5	ALZA CORPORATION	700 Eubanks Drive, 95688, Vacaville, CA, E. U. DE NORTEAMERICA	194
438562	03/10/2022	LATINADERM EXCELLENCE	41	Galderma Holding S.A.	Zählerweg 10, 6300, ZUG, SUIZA	245
438967	20/10/2022	VIRTUOSO TRAVEL WEEK	35	VIRTUOSO, LTD.	777 MAIN STREET, SUITE 900, 76102, Fort Worth, Texas, E. U. DE NORTEAMERICA	194
438968	18/10/2022	VIRTUOSO TRAVEL WEEK	41	VIRTUOSO, LTD.	777 MAIN STREET , SUITE 900 , 76102, Fort Worth, Texas, E. U. DE NORTEAMERICA	194
439157	09/11/2022	PHARMATON NATURAL HEALTH PRODUCTS	5, 29 y 30	Opella Healthcare Switzerland AG	Suurstoffi 2, Rotkreuz, 6343, SUIZA	144
441767	05/10/2022	SILCOR	5	Galderma Holding S.A.	Zählerweg 10, 6300, ZUG, SUIZA	245
442926	18/10/2022	VIEWSONIC	9	VIEWSONIC CORPORATION	10 Pointe Drive, Suite 200, 235, 255, 92821, Brea, CA, E. U. DE NORTEAMERICA	212
443051	04/10/2022	RETYLANE	3 y 10	Galderma Holding S.A.	Zählerweg 10, 6300, ZUG, SUIZA	245
443323	04/10/2022	SOOLANTRA	3 y 5	Galderma Holding S.A.	Zählerweg 10, 6300, ZUG, SUIZA	245
444224	11/10/2022	INACAL / INSTITUTO NACIONAL DE CALIDAD URUGUAY	42	INSTITUTO NACIONAL DE CALIDAD	AVDA. BURGUES 3208, Montevideo, Montevideo, URUGUAY	
444227	11/10/2022	MODELO URUGUAYO DE GESTIÓN DE LA INNOVACIÓN	42	INSTITUTO NACIONAL DE CALIDAD	Avda. Burgues 3208, Montevideo, Montevideo, URUGUAY	
444228	11/10/2022	PREMIO COMPROMISO CON LA GESTIÓN PUBLICA	42	INSTITUTO NACIONAL DE CALIDAD	Avda. Burgues 3208, 11700, Montevideo, Montevideo, URUGUAY	

N° Exp.	Resolución	Denominación	Clases	Titular	Dirección	Ag.
444229	11/10/2022	PREMIO MICRO Y PEQUEÑA EMPRESA	42	INSTITUTO NACIONAL DE CALIDAD	Avda. Burgues 3208, Montevideo, Montevideo, URUGUAY	
444399	13/10/2022	SAN ROQUE CENTRO	3	SAN ROQUE S.A.	Bulevar Artigas 1913, Montevideo, Montevideo, URUGUAY	34
444400	14/10/2022	SAN ROQUE CENTRO	9	SAN ROQUE S.A.	Bulevar Artigas 1913, Montevideo, Montevideo, URUGUAY	34
444401	13/10/2022	SAN ROQUE CENTRO	3 y 5	SAN ROQUE S.A.	Bulevar Artigas 1913, Montevideo, Montevideo, URUGUAY	34
446247	30/09/2022	GALDERMA	3, 5 y 10	Galderma Holding S.A.	Zählerweg 10, 6300, ZUG, SUIZA	245
447194	30/09/2022	GALDERMA	3 y 5	Galderma Holding S.A.	Zählerweg 10, 6300, ZUG, SUIZA	245
447556	30/09/2022	ELVALY	5	Galderma Holding S.A.	Zählerweg 10, 6300, ZUG, SUIZA	245
448253	09/11/2022		5 y 29	Opella Healthcare Switzerland AG	Suurstoffi 2, Rotkreuz, 6343, SUIZA	144
448961	17/10/2022	TIENDA DE REBAJAS	35	SAN ROQUE S.A.	Bulevar Artigas 1913,, Montevideo, URUGUAY	34
448963	17/10/2022	BELLEZA BELLEZA BELLE ELLEZA BELLEZA BELLEZA BELLEZA BELL ELLEZA BELLEZA BELLEZA BELLE LLEZA BELLEZA BELLEZA BELLEZ ELLEZA BELLEZA BELLEZA ELLEZA SALUD SALUD SALUD SAL LLEZA BELLEZA SALUD SALUD SAL ELLEZA SALUD	16, 35 y 36	SAN ROQUE S.A.	Bulevar Artigas 1913, MONTEVIDEO, URUGUAY	34

N° Exp.	Resolución	Denominación	Clases	Titular	Dirección	Ag.
		ALUD SALUD SALUD S ALUD SALUD SAL TARJETA SR SAN ROQUE SAN ROQUE FARMA				
448987	13/10/2022	SAN ROQUE PUNTOS	35 y 36	SAN ROQUE S.A	Bulevar Artigas 1913, MONTEVIDEO, URUGUAY	34
450120	14/10/2022	SAN ROQUE FARMA	16, 35 y 44	SAN ROQUE S.A.	Bulevar Artigas 1913, MONTEVIDEO, URUGUAY	34
450121	14/10/2022	SAN ROQUEFARMA	16, 35 y 44	SAN ROQUE S.A.	Bulevar Artigas 1913, MONTEVIDEO, URUGUAY	34
450908	25/10/2022		18, 25 y 28	LCS INTERNATIONAL SAS	8 rue Adolphe Seyboth, 67000, Strasbourg , FRANCIA	18
451281	10/11/2022	COLEMAN	11, 20, 21 y 22	THE COLEMAN COMPANY, INC.,	3600 North Hyrdaulic , 67219, Wichita, KS , E. U. DE NORTEAMERICA	212
452798	03/10/2022	DAYLONG	3	Galderma Holding S.A.	Zählerweg 10, 6300, ZUG, SUIZA	245
454003	14/10/2022	DIAMANTES	3	SAN ROQUE S.A.	Bulevar Artigas 1913, Montevideo, Montevideo, URUGUAY	34
454590	17/10/2022	LOCYCARE	3	Galderma Holding S.A.	Zählerweg 10, 6300, ZUG, SUIZA	245
454846	18/10/2022	ROTHSCHILD	36	Rothschild & Co Continuation Holdings AG.	Baarerstrasse 95, 6300, Zug, SUIZA	194
455516	03/10/2022	IONAX	3	Galderma Holding S.A.	Zählerweg 10, 6300, ZUG, SUIZA	245
458116	05/10/2022	NUTRAPLUS	3	Galderma Holding S.A.	Zählerweg 10, 6300, ZUG, SUIZA	245
459040	05/10/2022	NUTRAPLUS	5	Galderma Holding S.A.	Zählerweg 10, 6300, ZUG, SUIZA	245
460047	07/11/2022	HIAB	7, 37 y 39	HIAB AB	c/o Cargotec Sweden AB, Box 1133, 164 22 , Kista, SUECIA	181
460252	21/10/2022	SINBAR	1	TESSENDERLO	2910 N. 44th Street, Suite 100,	201

N° Exp.	Resolución	Denominación	Clases	Titular	Dirección	Ag.
				KERLEY, INC.	85018, Phoenix, ARIZONA, E. U. DE NORTEAMERICA	
461306	11/11/2022	AREXONS	1, 2, 3 y 4	PETRONAS LUBRICANTS ITALY S.p.A.	VIA SANTENA 1, VILLASTELLONE, 10029 , (TO) , ITALIA	165
461375	05/10/2022	ONYMAX	5	Galderma Holding S.A.	Zählerweg 10, 6300, ZUG, SUIZA	245
462053	14/10/2022	SANTA UNA MARCA DE SAN ROQUE	3	SAN ROQUE S.A	Bulevar Artigas 1913, MONTEVIDEO, URUGUAY	180
462054	14/10/2022	SANTA UNA MARCA DE SAN ROQUE	14	SAN ROQUE S.A	Bulevar Artigas 1913, MONTEVIDEO, URUGUAY	180
462055	14/10/2022	SANTA UNA MARCA DE SAN ROQUE	24	SAN ROQUE S.A	Bulevar Artigas 1913, MONTEVIDEO, URUGUAY	180
462056	14/10/2022	SANTA UNA MARCA DE SAN ROQUE	25	SAN ROQUE S.A	Bulevar Artigas 1913, MONTEVIDEO, URUGUAY	180
463602	20/10/2022	VIRTUOSO	35, 39 y 43	VIRTUOSO LTD.	777 MAIN STREET, SUITE 900, 76102, Fort Worth, Texas, E. U. DE NORTEAMERICA	144
464077	09/11/2022	G 115	5	Opella Healthcare Switzerland AG	Suurstoffi 2, Rotkreuz, 6343, SUIZA	144
464233	03/10/2022	LOCERYL	5	Galderma Holding S.A.	Zählerweg 10, 6300, ZUG, SUIZA	245
464234	05/10/2022	SANSACNE	5	Galderma Holding S.A.	Zählerweg 10, 6300, ZUG, SUIZA	245
464650	04/11/2022	CALLEBAUT	30	BARRY CALLEBAUT AG	Hardturmstrasse 181, 8005, Zurich, SUIZA	94
464987	31/10/2022	MINIMA MEDLEY	5	Medley Farmacêutica Ltda.	Rua Macedo Costa 55, Jardim Santa Genebra , 13080-180, Campinas, Sao Paulo, BRASIL	165
465073	18/10/2022	N1	9	PATRICIA FALERO CALLEJAS	Avda. A La Playa N° 1 Apto. 104, CANELONES, URUGUAY	94
465118	30/09/2022	GALDERMA	3, 5 y 10	Galderma Holding S.A.	Zählerweg 10, 6300, ZUG, SUIZA	245
466472	05/10/2022	SCULPTRA	3, 5 y 10	Galderma Holding S.A.	Zählerweg 10, 6300, ZUG, SUIZA	245

N° Exp.	Resolución	Denominación	Clases	Titular	Dirección	Ag.
					SUIZA	
471337	30/09/2022	DESOWEN	5	Galderma Holding S.A.	Zählerweg 10, 6300, ZUG, SUIZA	245
473299	05/10/2022	NUTRADERM	3, 10 y 44	Galderma Holding S.A.	Zählerweg 10, 6300, ZUG, SUIZA	245
475255	07/11/2022	CINADIA	5	SMITHKLINE BEECHAM (CORK) LIMITED	12 Riverwalk, Citywest Business Campus, Dublin 24, IRLANDA	216
475403	30/09/2022	CLOB-X	5	Galderma Holding S.A.	Zählerweg 10, 6300, ZUG, SUIZA	245
478974	21/10/2022	TESSENDERLO KERLEY	1	Tessengerlo Kerley, Inc.	2910 N. 44th Street, Suite 100, 85018, Phoenix, ARIZONA, E. U. DE NORTEAMERICA	201
480086	05/10/2022	SILKIS	5	Galderma Holding S.A.	Zählerweg 10, 6300, ZUG, SUIZA	245
480599	17/10/2022	CROMARGAN	8 y 11	WMF GmbH	WMF Platz 1, 73312, Geislingen an der Steige , ALEMANIA	144
480990	24/10/2022	SINBAR	5	Tessengerlo Kerley, Inc.	2910 N. 44th Street, Suite 100, 85018, Phoenix, Arizona, E. U. DE NORTEAMERICA	201
481193	03/11/2022	PRESTAMO LIBRE MILA	36	SEVIER S.A.	YI 1530, Montevideo, Montevideo, URUGUAY	184
481271	07/11/2022		3	Anastasia Beverly Hills, LLC.	10635 Santa Monica Boulevard, Suite 300, 90025, Los Angeles, California, E. U. DE NORTEAMERICA	201
481720	22/11/2022	XESS	7, 9, 11 y 35	TCL Technology Group Corporation	, TCL Technology Building, 17 Huifeng 3rd Road, Zhongkai High Technology Development District, Huizhou, Guangdong , CHINA	144
482249	05/10/2022	ROZEX	5	Galderma Holding S.A.	Zählerweg 10, 6300, ZUG, SUIZA	245

N° Exp.	Resolución	Denominación	Clases	Titular	Dirección	Ag.
482868	21/11/2022	CROCS	9, 14, 18, 25 y 35	CROCS, INC.	13601 Via Varra, 80020, Broomfield, Colorado, E. U. DE NORTEAMERICA	212
483219	06/10/2022	LUMAX	6 y 28	CINAMON URUGUAY S.A.S.	SORIANO 932, MONTEVIDEO, URUGUAY	189
484379	24/10/2022	HYDRAFACIAL	3, 10 y 44	HydraFacial LLC	2165 E. Spring Street Long Beach, 90806, California, E. U. DE NORTEAMERICA	245
487516	08/11/2022	A MEN	3	Azzaro Mugler Beaute	14 Rue Royale 75008, 75008, Paris, Paris, FRANCIA	144
487718	09/11/2022	KIDDI	5	Opella Healthcare Switzerland AG	Suurstoffi 2, Rotkreuz, 6343, SUIZA	144
488610	15/11/2022	MORVAL VONWILLER ADVISORS	35, 36 y 45	MORVAL VONWILLER ADVISORS S.A.	Rue Charles- Galland 18, 1206, Geneva, SUIZA	216
493571	19/10/2022	MANOLITA BY PATY EVIA	25	PATRICIA EVIA	Brunel 2940 , Montevideo, URUGUAY	144
494644	10/11/2022	PHARMATON	5	Opella Healthcare Switzerland AG	Suurstoffi 2, 6343, Rotkreuz, SUIZA	144
495262	22/11/2022	CAOL ILA	33	DIAGEO SCOTLAND LIMITED	11 LOCHSIDE PLACE, EH12 9HA, Edinburgh, Scotland, GRAN BRETAÑA (REINO UNIDO)	144
495786	27/10/2022	SOL COPY	16	PAPER AUSTRALIA PTY LTD	Botanicka, Building 1, 572 Swan Street, 3121, Burnley , Victoria , AUSTRALIA	34
498082	08/11/2022	PHARMATON	5	Opella Healthcare Switzerland AG	Suurstoffi 2, 6343, ROTKREUZ, SUIZA	144
498574	09/11/2022	PAE PAN AMERICAN ENERGY	4, 37, 39, 40 y 42	PAN AMERICAN ENERGY, S.L.	Arbea Campus Empresarial, Edificio 1, Ctra. Fuencarral a Alcobendas, M603, 3,8 Km Alcobendas, Madrid, 28108, -, MADRID, ESPAÑA	94
498703	30/09/2022	DIFFERIN	5	Galderma Holding S.A.	Zählerweg 10, 6300, ZUG, SUIZA	245

N° Exp.	Resolución	Denominación	Clases	Titular	Dirección	Ag.
499258	15/11/2022	D' AUCY	29	D'AUCY FRANCE	Kerlurec THEIX-NOYALO , 56450, FRANCIA	245
500736	08/11/2022	PHARMATON	5	Opella Healthcare Switzerland AG	Suurstoffi 2, 6343 Rotkreuz,, 6343, ROTKREUZ, SUIZA	144
500738	08/11/2022	PHARMATON	5	Opella Healthcare Switzerland AG	Suurstoffi 2, 6343 Rotkreuz, 6343, ROTKREUZ, SUIZA	144
500739	08/11/2022	PHARMATON	5	Opella Healthcare Switzerland AG	Suurstoffi 2, 6343 Rotkreuz, 6343, ROTKREUZ, SUIZA	144
500740	08/11/2022	PHARMATON	5	Opella Healthcare Switzerland AG	Suurstoffi 2, 6343, ROTKREUZ, SUIZA	144
500804	08/11/2022	PHARMATON	5	Opella Healthcare Switzerland AG	Suurstoffi 2, 6343, ROTKREUZ, SUIZA	144
500805	10/11/2022	PHARMATON	5	Opella Healthcare Switzerland AG	Suurstoffi 2, 6343 Rotkreuz, 6343, Rotkreuz, SUIZA	144
501877	14/11/2022	PICANTO	12	KIA CORPORATION	12, Heolleung-ro, Seocho-gu , Seoul, COREA DEL SUR	34
501878	14/11/2022	K2500	12	KIA CORPORATION	12, Heolleung-ro, Seocho-gu , Seoul, COREA DEL SUR	201
501879	06/10/2022	HAIFU	9 y 10	Chongqing Haifu Medical Technology Co., Ltd.	NO.359 JINGDONGFANG AVENUE, BEIBEI DISTRICT, CHONGQING, CHINA	34
503569	05/10/2022	NUTRADERM	5	Galderma Holding S.A.	Zählerweg 10, 6300, ZUG, SUIZA	245
506248	03/11/2022	HOZON	9 y 12	Hozon New Energy Automobile Co., Ltd.	No.988, Tongren Road, Wutong Street, Tongxiang city, Jiaxing city, Zhejiang Province, CHINA	144
506249	03/11/2022	NETA	12	Hozon New Energy Automobile Co., Ltd.	No.988, Tongren Road, Wutong Street, Tongxiang city, Jiaxing city, Zhejiang Province, CHINA	144
508393	30/09/2022	CLOBEX	5	Galderma Holding S.A.	Zählerweg 10, 6300, ZUG, SUIZA	245
509655	09/11/2022	VAN HOUTEN	30	BARRY CALLEBAUT AG	Hardturmstrasse 181, 8005, Zurich, SUIZA	94
509812	24/10/2022	THIO-SUL	1	Tessengerlo Kerley, Inc.	2910 N. 44th Street, Suite 100,	201

N° Exp.	Resolución	Denominación	Clases	Titular	Dirección	Ag.
					85018, .PHOENIX, ARIZONA, E. U. DE NORTEAMERICA	
510471	10/11/2022	YAKULT	29	KABUSHIKI KAISHA YAKULT HONSHA	1-10-30, Kaigan, Minato-ku, 105- 8660, Tokyo, JAPON	194
513672	22/11/2022	CORBIS	35 y 45	Unity Glory International Limited	B5 Universal Business Park No. 10, Jiuxiangiao St., Chaoyang Dist., 100015, Beijing, HONG KONG	136
514095	05/10/2022	NUTRACORT	5	Galderma Holding S.A.	Zählerweg 10, 6300, ZUG, SUIZA	245
514096	03/10/2022	IONAX	5	Galderma Holding S.A.	Zählerweg 10, 6300, ZUG, SUIZA	245
514375	04/10/2022	RESTYLANE	5	Galderma Holding S.A.	Zählerweg 10, 6300, ZUG, SUIZA	245
514376	05/10/2022	TETRALYSAL	5	Galderma Holding S.A.	Zählerweg 10, 6300, ZUG, SUIZA	245
516884	06/10/2022	GAES	10	AMPLIFON IBÉRICA, S.A.	José María Lacarra de Miguel nº 18-20, 05008, Zaragoza, ESPAÑA	201
518044	09/11/2022	VAN LEER	30	Barry Callebaut AG	Hardturmstrasse 181, 8005, Zurich, SUIZA	94
518046	08/11/2022	CARMA	29 y 30	Barry Callebaut AG	Hardturmstrasse 181, 8005, Zurich, SUIZA	94
518052	04/11/2022	CACAO BARRY	30	Barry Callebaut AG	Hardturmstrasse 181, 8005, Zurich, SUIZA	94
521239	17/10/2022	VULKAN EYEWEAR	9	CABRERA GARRO MARCOS ALEXIS	RIVERA 435, SANTA LUCIA, MONTEVIDEO, URUGUAY	220
521786	30/09/2022	EPIDUO	5	Galderma Holding S.A.	Zählerweg 10, 6300, ZUG, SUIZA	245
521792	03/10/2022	METROGEL	5	Galderma Holding S.A.	Zählerweg 10, 6300, ZUG, SUIZA	245
521793	04/10/2022	ORACEA	5	Galderma Holding S.A.	Zählerweg 10, 6300, ZUG, SUIZA	245
525795	07/11/2022	BARRY CALLEBAUT	30	Barry Callebaut AG	Hardturmstrasse 181, 8005,	94

N° Exp.	Resolución	Denominación	Clases	Titular	Dirección	Ag.
					Zurich, SUIZA	
525797	07/11/2022		30	Barry Callebaut AG	Hardturmstrasse 181, 8005, Zurich, SUIZA	94
525798	07/11/2022	CACAO BARRY	30	Barry Callebaut AG	Hardturmstrasse 181, 8005, Zurich, SUIZA	94
525800	09/11/2022	SICAO	30	Barry Callebaut AG	Hardturmstrasse 181, 8005, Zurich, SUIZA	94
526490	10/11/2022	HOLCIM	1, 19, 37 y 42	Holcim AG	Grafenauweg 10, 6300, zug, SUIZA	192
527334	08/11/2022	JOSE CUERVO RESERVA DE LA FAMILIA	33	TEQUILA CUERVO, S.A. DE C.V.	Avenida Periférico Sur N° 8500, Tlaquepaque, Jalisco, 45609, -, -, MEXICO	194
529701	11/11/2022	KIA ECO DYNAMICS	12	KIA CORPORATION	12, Heolleung-ro, Seocho-gu , Seoul, COREA DEL SUR	201
542590	17/10/2022	GOLDEN GOOSE	18 y 25	Golden Goose S.p.A.	Via Privata Ercole Marelli 10, 20139, Milano, ITALIA	212

CAMBIOS DE DOMICILIO DE FRASES PUBLICITARIAS

N° Exp.	Resolución	Denominación	Clases	Titular	Dirección	Ag.
358558	20/10/2022	ESPECIALISTAS EN EL ARTE DE VIAJAR (SPECIALISTS IN THE ART OF TRAVEL)	39 y 43	VIRTUOSO, LTD.	777 MAIN STREET, SUITE 900, 76102, Fort Worth, Texas, E. U. DE NORTEAMERICA	20
397957	20/10/2022	LA RENOVACION ESTA EN EL CAMBIO	2 y 27	RAMALUX S.A.	Ruta 8 km 23.500, BARROS BLANCOS, Canelones, URUGUAY	239

CAMBIOS DE DOMICILIO DESISTIDOS (Art. 92, D. 34/999)

N° Exp.	Resolución	Denominación	Clases	Titular	Dirección	Ag.
406936	21/11/2022	MC GIVER	17	MARIA FERNANDA GARZA MERODIO	Camino a Santa Teresa 181-1 Col, jardines del Pedregal, 01900, Mexico D.F., MEXICO	144

CAMBIOS DE DOMICILIO DE PATENTES

N° Exp.	Resolución	Titular	Dirección	Ag.
037380	17/10/2022	ONCONOVA THERAPEUTICS, INC.		34
037587	21/11/2022	REGENXBIO INC.		165
037679	21/11/2022	REGENXBIO INC.		165
037885	21/10/2022	LO.LI PHARMA S.R.L.		219
037919	22/11/2022	Receptor Holdings, Inc.		216
039335	17/10/2022	EUROFARMA LABORATORIOS S.A.		34

INSCRIPCIONES DE LICENCIAS

N° Exp.	Resolución	Denominación	Clases	Titular	Dirección	Ag.
412688	18/10/2022	OROWEAT SANDWICH	30	GRUPO BIMBO S.A.B. DE C.V.	Prolongación Paseo de la Reforma 1000, 01210, México, D.F., MEXICO	29
450196	22/09/2022	AXION ENERGY AXION	4, 37 y 39	PAN AMERICAN ENERGY GROUP, S.L.	Arbea Campus Empresarial, Edificio Número 1, Carretera de Fuencarral a Alcobendas, M-603, 3.8 Km., 28108, Alcobendas, Madrid, ESPAÑA	94
471496	05/10/2022	FORMICA	1	THE DILLER CORPORATION	10155 Reading Road, 45241, Cincinnati, Ohio, E. U. DE NORTEAMERICA	18
500250	05/10/2022	/ N+	3	MICHEL SABETAY SISIASVILI AIZEN	José María Montero 2830, Montevideo, Montevideo, Montevideo, URUGUAY	212
500669	23/11/2022	PRO LIMPIO	3 y 35	SUBATIR S.A.	25 DE MAYO 725, SAN JOSE DE MAYO, SAN JOSE, URUGUAY	189

INSCRIPCIONES DE LICENCIAS, DESESTIMADAS (Art. 92, D. 34/999)

N° Exp.	Resolución	Denominación	Clases	Titular	Dirección	Ag.
420480	05/10/2022	CALIDAD DON CABRERA	30 y 43	SANDRA	Candelaria 1823, Montevideo,	189

N° Exp.	Resolución	Denominación	Clases	Titular	Dirección	Ag.
				TAGLIASACCHI BAUTISTA	Montevideo, URUGUAY	

INSCRIPCIONES DE SUBLICENCIAS

N° Exp.	Resolución	Denominación	Clases	Titular	Dirección	Ag.
444920	05/10/2022	PIRACALAMINA	5	LABORATORIOS SZAMA S.A.	Lafuente 161, 1406, Buenos Aires, Buenos Aires, ARGENTINA	218

INSCRIPCIONES DE PRENDAS

N° Exp.	Resolución	Denominación	Clases	Titular	Dirección	Ag.
498996	23/11/2022	CHATEAU THIERRY	33	VINICOLA FOND DE CAVE S.A.	Convencion 1343 Esc. 902,, -, Montevideo, Montevideo, URUGUAY	18

INSCRIPCIONES DE RENUNCIAS TOTALES

N° Exp.	Resolución	Denominación	Clases	Titular	Dirección	Ag.
405042	08/11/2022	ANITA	5	PHARMA DEVELOPMENT SA	Maipù 509, 4ª Piso, Buenos Aires, ARGENTINA	212
422330	10/11/2022	MARAFLEX	16	BEMIS COMPANY, INC.	One Neenah Center 4th Floor, 134 E. Wisconsin Avenue, Neenah, E. U. DE NORTEAMERICA	34
456849	18/10/2022	CROSSA	12	SUZUKI MOTOR CORPORATION	300 Takatsuka-cho, Minami-ku, Hamamatsu-shi, Shizuoka-ken, JAPON	194
457307	13/10/2022	DAUPHIN	12 y 37	AIRBUS HELICOPTERS	Aéroport International Marseille Provence, 13725, Marignane, Cedex, FRANCIA	165
509702	25/10/2022	NEFERSIL	5	PHARMA DEVELOPMENT S.A.	Maipù 509, 4º piso, Ciudad Autónoma de Buenos Aires, C1006ACE, Ciudad Autónoma	212

N° Exp.	Resolución	Denominación	Clases	Titular	Dirección	Ag.
					de Buenos Aires, Ciudad Autónoma de Buenos Aires, ARGENTINA	
509703	25/10/2022	PRENEOFAR	5	PHARMA DEVELOPMENT S.A.	Maipú 509, 4° piso, Ciudad Autónoma de Buenos Aires, C1006ACE, Ciudad Autónoma de Buenos Aires, Ciudad Autónoma de Buenos Aires, ARGENTINA	212
509808	25/10/2022	SPICA HI PHONE	9	MOTOCICLO S.A.	AVDA. SAYAGO 1385, MONTEVIDEO, MONTEVIDEO, MONTEVIDEO, URUGUAY	201

INSCRIPCIONES DE RENUNCIAS PARCIALES

N° Exp.	Resolución	Denominación	Clases	Titular	Dirección	Ag.
424231	03/10/2022	ELEA	42, 43, 44 y 45	LABORATORIO ELEA PHOENIX S.A.	Avenida Del Libertador 6550 3° Piso, Ciudad Autónoma de Buenos Aires, ARGENTINA	34
428565	14/10/2022	CARNICENTRO	18, 29 y 31	FRIGORIFICO SAN JACINTO NIREA S.A.	ruta 7 km. 59.500, san jacinto, canelones, URUGUAY	118
457419	13/10/2022	QUESOTECA CLUB	41 y 43	ALVARO RABUÑAL, y MARCELO RIVEDIEU	Lafinur 2130, Montevideo, URUGUAY	180
466872	03/10/2022	LATAM	37, 38 y 39	LATAM Airlines Group S.A.	Avda. Presidente Riesco N° 5711, Piso 19, Santiago, CHILE	201
479122	03/10/2022	HIGHLIGHTS	41	GONZALO ALEJANDRO SOLIMANO	3 De Febrero 464, B1642FGJ, San Isidro, Buenos Aires, ARGENTINA	165
487985	03/11/2022	SOLARIS	5	Solaris Tecnología Agrícola S.A.	Plaza Cagancha 1356 Oficina 103, Montevideo, Montevideo, URUGUAY	94
498117	04/10/2022	NIO NEEDS ICE ONLY	33	NIOCOCKTAILS SRL	VIA ANSPERTO, 10, 20123, MILAN, ITALIA	34

N° Exp.	Resolución	Denominación	Clases	Titular	Dirección	Ag.
510633	03/11/2022	REGATTA SPORT	18, 24 y 25	BRAND LEADERS INC.	OBARRIO AVE.SAMUEL LEWIS Y CALLE 58 T.ADR. 6TO C, CIUDAD DE PANAMA, CIUDAD DE PANAMA, CIUDAD DE PANAMA, PANAMA	201
512420	04/11/2022	DOGA	30	MABLE S.A.	HERMOGENES ALVAREZ 3347, Montevideo, 11100, Montevideo, Montevideo, URUGUAY	94
529718	03/11/2022	EQUAZEN	5 y 29	SOHO FLORDIS UK LIMITED	DOUGLAS BANK HOUSE, WIGAN LANE, WIGAN, WN1 2TB, LANCASHIRE, LANCASHIRE, United Kingdom	34
535673	03/11/2022	HARINEL	29 y 30	MOLINO AMERICANO S.A.	Gral. Pacheco 1070, Montevideo, Montevideo, Montevideo, URUGUAY	34
537582	04/11/2022	CORAFEN	5	LB S.A.	Rambla República del Perú Nro de Puerta 1125, MONTEVIDEO, 11300, MONTEVIDEO, MONTEVIDEO, URUGUAY	
538481	04/11/2022	KIWITA	29, 30 y 31	JINGOLD SPA	Via Filippo Turati n.650, -, 47522, Cesena, Cesena, ITALIA	34

RESOLUCIONES DE RECURSOS, DNPI

N° Exp	Resolución	Marca	Clases	Titular	Ag.
506961	16/11/2022	MCCAIN SURECRISP (mixta) / MCCAIN FOODS LIMITED	29 (Concedida S/D)		

RESOLUCIONES DE RECURSOS DE RENOVACIONES, DNPI

N° Exp	Resolución	Marca	Clases	Titular	Ag.
513557	11/11/2022	VANGUARD / OTS LOGISTICS GROUP LTD.	39 (Concedida S/D)		94

RESOLUCIONES DE REIVINDICACIONES

N° Exp	Resolución	Marca	Clases	Titular	Ag.
522897	07/10/2022	SUPERMERCADO URUFRIO (mixta) / Lorenzo Rosales, Facundo Agustín	35 (Concedida)		28

RESOLUCIONES DE PATENTES, CONCEDIDAS

N° Exp	Resolución	Título	Titular	Ag.
No. 33839	31/10/2022	DISPOSITIVO DE OSTEOTOMIA MINIMAMENTE INVASIVA	MARTIN RUSSI	94
No. 34695	07/10/2022	VACUNA DE HERPESVIRUS-1 EQUINO RECOMBINANTE QUE CONTIENE GLICOPROTEÍNA C MUTADA Y USOS DE LA MISMA	Boehringer Ingelheim Animal Health USA Inc. y FREIE UNIVERSITÄT BERLIN	94
No. 34814	17/10/2022	MARCA PARA LA IDENTIFICACIÓN DE ANIMALES	ALLFLEX EUROPE SAS	189
No. 34950	07/10/2022	Composiciones de 3-(difluorometil)-Nmetoxi-1-metil-N-[1-metil-2-(2,4,6-triclorofenil)etil]pirazol-4-carboxamida que comprenden dos compuestos fungicidas adicionales.	SYNGENTA PARTICIPATIONS AG	20
No. 35193	17/10/2022	MÉTODO DE OXIDACIÓN CATALÍTICA DE LA CELULOSA Y MÉTODO PARA ELABORAR UN PRODUCTO DE CELULOSA	UPM-Kymmene Corporation	94
No. 35222	24/10/2022	“COMPOSICIONES HERBICIDAS SINÉRGICAS QUE COMPRENDEN FLUROXIPIR Y FLUMETSULAM”.	Corteva Agriscience LLC.	20
No. 35285	17/10/2022	ATURDIMIENTO EFECTIVO DE ANIMALES	WAGSTAFF FOOD SERVICES PTY. LTD.	180

N° Exp	Resolución	Título	Titular	Ag.
No. 35288	17/10/2022	PIRIDONAMIDAS COMO MODULADORES DE CANALES DE SODIO	VERTEX PHARMACEUTICALS, INC.	165
No. 35292	31/10/2022	COMPOSICIÓN BIONEMATICIDA Y MÉTODO PARA EL CONTROL DE NEMATODOS FITOPATÓGENOS UTILIZANDO LA MISMA	BIO INSUMOS NATIVA SpA	205
No. 35308	26/10/2022	SISTEMA DE IDENTIFICACIÓN ANIMAL QUE INCLUYE UNA PARTE MACHO, UNA PARTE HEMBRA Y UN DISPOSITIVO EXTRAÍBLE PARA ALMACENAMIENTO DE UNA MUESTRA	ALLFLEX EUROPE SAS.	189
No. 35309	31/10/2022	NOVEDOSOS COMPUESTOS DE PIRAZOL HALOGENADO, COMPOSICIONES QUE LOS CONTIENEN Y USO DE LOS MISMOS	Vetoquinol SA.	216
No. 35324	14/11/2022	FORMULACIONES SÓLIDAS DE DEXKETOPROFENO Y TRAMADOL PARA ADMINISTRACIÓN ORAL Y MÉTODO PARA PREPARAR LAS MISMAS.	LABORATORIOS MENARINI S.A.	216
No. 35336	24/10/2022	QUEMADOR-REACTOR DE VACÍO Y MEZCLA DE COMBUSTIBLES	Jorge DE LA SOVERA	94
No. 35434	24/10/2022	“4-AMINO-6-(HETEROCÍCLICO)PICOLINATOS Y 6-AMINO-2-(HETEROCÍCLICO)PIRIMIDIN-4-CARBOXILATOS Y SU USO COMO HERBICIDAS”.	Corteva Agriscience LLC,	20
No. 35469	17/10/2022	Derivados de Triazolo[4,5-c] piridina como modulares del receptor P2X7	JANSSEN PHARMACEUTICA NV	192
No. 35495	31/10/2022	CONJUNTO DE DISPOSITIVOS PARA FORMAR OJALES EN ESLINGAS	I.P.H. S.A.I.C.F.	94
No. 35530	22/11/2022	MONTAJE PARA SISTEMA DE CONTENCIÓN DE TUBERÍAS	OMEGA FLEX INC.	34
No. 35569	31/10/2022	COMPUESTO REFORZADO CON FIBRA	UPM-Kymmene Corporation	216
No. 35609	17/10/2022	PUNTO DE SUJECIÓN DE CARRIL Y CUÑA PARA ESTE PUNTO DE SUJECIÓN DE CARRIL	VOSSLOH-WERKE GMBH	34
No. 35615	31/10/2022	DISPOSITIVO PARA LA PREPARACIÓN Y EL	FILIPICH, CARLOS DAMIAN y FILIPICH, CARLOS	180

N° Exp	Resolución	Título	Titular	Ag.
		DISPENSADO DE INFUSIONES DE FÁCIL LIMPIEZA	PEDRO	
No. 35623	07/11/2022	NANOMATERIAL DE DIÓXIDO DE TITANIO NANOPARTICULADO MODIFICADO CON GRUPOS FUNCIONALES Y CON EXTRACTOS CÍTRICOS ADSORBIDOS EN LA SUPERFICIE PARA LA ELIMINACIÓN DE AMPLIO ESPECTRO DE MICROORGANISMOS	INMOLECULE INTERNATIONAL LIMITED	201
No. 35630	17/10/2022	CARBOXAMIDAS PRIMARIAS COMO INHIBIDORES DE BTK	AbbVie Inc.	218
No. 35638	17/10/2022	MÉTODO PARA REDUCIR EL FÓSFORO EN EFLUENTES Y AGUAS DEL PROCESO	UPM-Kymmene Corporation	94
No. 35658	24/10/2022	“CONJUNTO DE BOTELLA QUE INCLUYE CONJUNTO DE VENTILACIÓN DE CONFIGURACIÓN DUAL”.	HANDI-CRAFT COMPANY	20
No. 35673	31/10/2022	PROCEDIMIENTO DE FABRICACIÓN DE FIBRAS SINTÉTICAS ESTRUCTURALES PARA HORMIGONES Y MORTEROS, Y FIBRA SINTÉTICA OBTENIDA	MYPHOR MATERIALES ESPECIALES, S.L.	34
No. 35676	31/10/2022	“CONJUNTO DE MONTAJE PARA PANELES DE CERRAMIENTO”	Natalio Ruben Faingold	20
No. 35680	07/11/2022	MÉTODO DE OXIDACIÓN CATALÍTICA DE LA CELULOSA Y MÉTODO PARA ELABORAR UN PRODUCTO DE CELULOSA	UPM-Kymmene Corporation	94
No. 35709	17/10/2022	APARATO DE CONECTOR AUTOAJUSTABLE PARA MIEMBROS DE DESGASTE Y SOPORTE DE ENGRANAJE A TIERRA.	HENSLEY INDUSTRIES, INC.	189
No. 35731	07/11/2022	COMPUESTOS DE ÉTER DE INDANOL SUSTITUIDOS	Peloton Therapeutics, Inc.	144
No. 35732	22/11/2022	COMPOSICIONES TERAPÉUTICAS DE NUCLEÓTIDOS Y NUCLEÓSIDOS Y USOS RELACIONADOS CON LAS MISMAS	EMORY UNIVERSITY	34
No. 35787	24/10/2022	(S)-1-(4-fluorofenil)-1-(2-(4-(6-(1-metil-1H-pirazol-4-il)pirrolo[2,1-f][1,2,4]triazin-4-il)piperazin-1-il)pirimidin-5-il)etanamina), sales del mismo y composiciones que lo	BLUEPRINT MEDICINES CORPORATION	216

N° Exp	Resolución	Título	Titular	Ag.
		comprenden		
No. 35825	17/10/2022	“CONCENTRADOS DE EMULSIÓN PESTICIDA QUE CONTIENEN ACEITES NATURALES O DERIVADOS DE PETRÓLEO Y MÉTODOS DE USO”	CORTEVA AGRISCIENCE LLC	20
No. 35826	31/10/2022	REACTOR PARA EL TRATAMIENTO DE PETRÓLEO Y DERIVADOS DE PETRÓLEO Y PROCEDIMIENTO DE TRATAMIENTO DE PETRÓLEO Y DERIVADOS DE PETRÓLEO QUE COMPRENDE SU USO	PETROLEO BRASILEIRO S.A. PETROBRAS	216
No. 35855	31/10/2022	COMPOSICIONES AGROQUÍMICAS QUE TIENEN RESISTENCIA A LA LLUVIA AUMENTADA	UPL LIMITED	156
No. 35863	17/10/2022	“HERBICIDAS DE PIRROLIDINONA”.	FMC CORPORATION	20
No. 35878	24/10/2022	“DISPOSITIVO DE CALENTAMIENTO ELÉCTRICO”	TOTAL SA	20
No. 35879	22/11/2022	“BANDA COMPUESTA, Y MÉTODOS PARA FORMAR UNA UNIÓN ENTRE DOS CONDUCTOS “	TOTAL SA	20
No. 35880	22/11/2022	“MÉTODO PARA FORMAR UNA CONEXIÓN ELÉCTRICA”	TOTAL SA	20
No. 35886	22/11/2022	UNA FORMULACION ACUOSA DE MEJORADOR DE FLUJO PARA PRODUCTOS REFINADOS	LiquidPowe Specialty Products Inc.	136
No. 36018	17/10/2022	“MÉTODO PARA LA HIDRÓLISIS DE UNA MEZCLA BIOMASA”.	Renmatix, Inc.	20
No. 36085	07/11/2022	ACCESORIO DE SILLAS DE RUEDAS PARA LA PRACTICA DEL DEPORTE DE BALOMPIE Y SILLA DE RUEDAS PROVISTA DE DICHO ACCESORIO	Organización de Servicios Ortopédicos Totales, S.L. y Fernando Giner Gil	101
No. 36127	14/11/2022	MÉTODO PARA UTILIZAR LA LIGNINA SEPARADA A PARTIR DEL LICOR NEGRO COMO COMBUSTIBLE EN UN HORNO DE CAL	ANDRITZ OY	216
No. 36167	22/11/2022	ACCESORIOS PARA SU USO CON CABLE BLINDADO	OMEGA FLEX, INC.	34
No. 36480	14/11/2022	COMPOSICIONES DE PICOLINAMIDAS, MÉTODO PARA EL CONTROL Y PREVENCIÓN DEL ATAQUE DE PATÓGENOS FÚNGICOS EN UNA PLANTA.	DOW AGROSCIENCES LLC	20
No. 37634	17/10/2022	COMPOSICIONES DE INHIBIDORES DE LA	Dow AgroSciences LLC	211

N° Exp	Resolución	Título	Titular	Ag.
		NITRIFICACIÓN MICROENCAPSULADOS		
No. 38698	14/11/2022	MODIFICACIÓN DE LA BIOSÍNTESIS DE FRUCTANOS, AUMENTANDO LA BIOMASA VEGETAL Y MEJORANDO LA PRODUCTIVIDAD DE LAS VÍAS BIOQUÍMICAS EN UNA PLANTA	AGRICULTURE VICTORIA SERVICES PTY LTD	18
No. 38865	22/11/2022	MOTOR DE 2 Y 4 TIEMPOS DE ALTO RENDIMIENTO, NO CONTAMINANTE	Miguel Hugo Ruchi Vaz	
No. 39084	24/10/2022	“COMPOSICIONES HERBICIDAS DE AMICARBAZONA Y MESOTRIONA Y MÉTODOS DE USO DE LAS MISMAS	Arysta LifeScience Corporation	165

RESOLUCIONES DE DISEÑOS INDUSTRIALES, CONCEDIDAS

N° Exp	Resolución	Título	Titular	Ag.
No. 4879	07/10/2022	AUDÍFONOS	Apple Inc.	216
No. 4880	17/10/2022	ESTUCHE	Apple Inc.	216
No. 4881	17/10/2022	CAJA DE DISTRIBUCIÓN DE ENERGÍA ELÉCTRICA	IDE ELECTRIC S.L.	216
No. 4882	24/10/2022	CAJA DE DISTRIBUCIÓN DE ENERGÍA ELÉCTRICA	IDE ELECTRIC S.L.	216
No. 4883	24/10/2022	CAJA DE DISTRIBUCIÓN DE ENERGÍA ELÉCTRICA	IDE ELECTRIC S.L.	216
No. 4884	31/10/2022	CAJA DE DISTRIBUCIÓN DE ENERGÍA ELÉCTRICA	IDE ELECTRIC S.L.	216
No. 4890	31/10/2022	ESTUCHE PARA KIT PARRILLERO	Cristina Barrios	
No. 4895	07/11/2022	UNA MOTOCICLETA	Honda Motor Co., Ltd.	94
No. 4898	07/11/2022	MÁQUINA DE BEBIDAS	CAFÉ TRÊS CORAÇÕES S/A	181
No. 4903	14/11/2022	APLICADOR DE CARAVANAS PARA ANIMALES	Allflex Australia Pty Limited y Chevillot SAS	235
No. 4904	22/11/2022	MATE - TERMO PARLANTE	Leonardo Saggese	

RESOLUCIONES DE PATENTES, DESESTIMADAS

N° Exp	Resolución	Título	Titular	Ag.
No. 34567	07/10/2022	MÉTODO Y SISTEMA PARA TRANSCODIFICAR CONTENIDO EN MODO REMOTO	Vrio Corp.	218

N° Exp	Resolución	Título	Titular	Ag.
No. 34633	22/11/2022	MÉTODO PARA LA CERTIFICACIÓN DEL ENVÍO DE CORREO ELECTRÓNICO	LLEIDANETWORKS SERVEIS TELEMATICS, S.A.	212
No. 34634	07/10/2022	MÉTODO PARA LA CERTIFICACIÓN DEL ENVÍO DE MENSAJES DE DATOS A TERMINALES MÓVILES	LLEIDANETWORKS SERVEIS TELEMATICS, S.A.	212
No. 35190	07/11/2022	Composición farmacéutica oral de dosis alta que contiene diosmina o una fracción de flavonoides que es una mezcla de diosmina, hesperidina, isorhoifolina, linarina y diosmetina	LES LABORATOIRES SERVIER	18
No. 35247	31/10/2022	“Mezcla fungicida sinérgica de (3S,6S,7R,8R)-8-bencil-3-(3-((isobutiriloxi)metoxi)-4-metoxipicolinamido)-6-metil-4,9-dioxo-1,5-dioxonan-7-il isobutirato y fluxapiroxad, composición fungicida y método de tratamiento de una planta”	Corteva Agriscience LLC.	211
No. 35254	07/10/2022	Una mezcla fungicida sinérgica de un compuesto de la Fórmula I, isobutirato de (3S,6S,7R,8R)-8-bencil-3-(3-((isobutiriloxi)metoxi)-4-metoxipicolinamido)-6-metil-4,9-dioxo-1,5-dioxonan-7-ilo y un fungicida triazol	CORTEVA AGRISCIENCE LLC	20
No. 35255	07/10/2022	Mezcla fungicida sinérgica que comprende un compuesto de formula I y un fungicida seleccionado de triciclazol, carpropamida, probenazol, kasugamicina, boscalid	CORTEVA AGRISCIENCE LLC	20
No. 35256	14/11/2022	Método para controlar manchas en hojas de remolachas azucareras	Corteva Agriscience LLC	20
No. 35279	07/11/2022	“COMPOSICIONES HERBICIDAS QUE COMPRENDEN ÁCIDO 4-AMINO-3-CLORO-6-(4-CLORO-2-FLUORO-3-METOXIFENIL)PIRIDINA-2-CARBOXÍLICO O UN DERIVADO DE ESTE Y PROPIZAMIDA”.	Corteva Agriscience LLC	20
No. 35281	07/11/2022	COMPOSICIONES QUE INCLUYEN AGENTES PARA CONFERIR CARÁCTER HIDROFÓBICO Y ESTABILIZANTES Y MÉTODOS PARA ELABORAR Y	GEORGIA-PACIFIC CHEMICALS LLC	216

N° Exp	Resolución	Título	Titular	Ag.
		USAR LOS MISMOS		
No. 35283	31/10/2022	“COMPOSICIONES HERBICIDAS QUE COMPRENDEN ÁCIDO 4-AMINO-3-CLORO-6-(4-CLORO-2-FLUORO-3-METOXIFENIL)PIRIDINA-2-CARBOXÍLICO O UN DERIVADO DE ESTE Y PICLORAM O UN DERIVADO DE ESTE”	Corteva Agriscience LLC	20
No. 35345	07/11/2022	Manipulación de la Auto-incompatibilidad en Plantas	Dairy AUSTRALIA LIMITED y Agriculture Victoria Services Pty Ltd	18
No. 35367	17/10/2022	FORMULACIONES ORALES DE DEFERASIROX	NOVARTIS AG	94
No. 35498	24/10/2022	“UN MÉTODO PARA MEJORAR LA TOLERANCIA DE UNA PLANTA A UN HERBICIDA QUE INHIBE HPPD, COMPOSICIÓN HERBICIDA Y USO”.	SYNGENTA PARTICIPATIONS AG	20
No. 35539	31/10/2022	CATAMARAN AUTOPROPULSADO PARA LA RECOLECCION DE RESIDUO SOLIDOS EN PUERTOS, RIOS, LAGOS Y LAGUNAS	CONTROL ECOLOGICO S.A.	220
No. 35562	14/11/2022	Composición farmacéutica dérmica percutánea para el tratamiento del sobrepeso y la obesidad en base a benzopironas, hidrosmina, hamamelis, aloe, cáscara de naranja, menta, vitamina C y llantén.	Graciela Figueiredo Rodriguez	
No. 35563	22/11/2022	METODO DE SELECCIÓN, PRODUCCION Y ALIMENTACION DE ALGAS ENTERAS COMO SUPLEMENTO ALMENTICIO PARA GANADO, PARA PRODUCIR CARNE RICA EN OMEGA 3 PARA LA SALUD HUMANA	DONALD M. SMITH	136
No. 35753	17/10/2022	COMPOSICIONES QUE COMPRENDEN BIFENTRINA Y MÉTODOS PARA MEJORAR EL CRECIMIENTO DE LAS PLANTAS, UTILIZANDO DICHAS COMPOSICIONES	FMC CORPORATION	189
No. 35766	24/10/2022	PROCESO INDUSTRIAL PARA LA SÍNTESIS DE INGREDIENTES ACTIVOS ESTEROIDES	Richter Gedeon Nyrt.	216
No. 35768	31/10/2022	PROCEDIMIENTO DE PREPARACIÓN DE HUEVOS	Cristiani Acuña, Rodolfo	180

N° Exp	Resolución	Título	Titular	Ag.
		DUROS CON MAYOR VIDA ÚTIL		
No. 35784	07/11/2022	FORMAS FARMACÉUTICAS DE DOSIFICACIÓN QUE COMPRENDEN 1-[6-(MORFOLIN-4-IL)PIRIMIDIN-4-IL]-4-(1H-1,2,3-TRIAZOL-1-IL)-1H-PIRAZOL-5-OLATO DE SODIO	BAYER PHARMA AG	211
No. 35895	07/11/2022	“COMPOSICIONES HERBICIDAS QUE CONTIENEN FLUMIOXAZINA, AMINOPIRALID Y FLUROXIPIR O 2,4-D”.	Corteva Agriscience LLC	20
No. 35896	14/11/2022	“CONTROL HERBICIDA SINÉRGICO DE MALEZA A PARTIR DE COMBINACIONES DE 2,4-D-COLINA Y GLIFOSATO”.	DOW AGROSCIENCES LLC	20
No. 36289	24/10/2022	ANTICUERPOS MONOCLONALES QUE ENLAZAN INMUNOESPECIFICAMENTE A CD123 y COMPOSICIONES QUE LOS CONTIENEN	JANSSEN PHARMACEUTICA N.V.	192
No. 39124	31/10/2022	ANTICUERPO AISLADO O FRAGMENTO DE ÉSTE QUE ENLAZAN BETA-KLOTHO, RECEPTORES FGF Y COMPLEJOS DE LOS MISMOS	AMGEN INC.	216
No. 39290	07/11/2022	UN MÉTODO PARA DISMINUIR LA INMUNOGENICIDAD DE UN FRAGMENTO DE ANTICUERPO QUE COMPRENDE UNA CADENA LIGERA VARIABLE Y/O UNA CADENA PESADA VARIABLE	ESBATECH, AN ALCON BIOMEDICAL RESEARCH UNIT LLC	144
No. 39769	22/11/2022	MEZCLAS PESTICIDAS QUE INCLUYEN DERIVADOS ISOXAZOLÍNICOS; MÉTODO PARA CONTROLAR INSECTOS ACÁRIDOS, NEMATODOS O MOLUSCOS Y MÉTODO PARA RECUBRIR UNA SEMILLA	SYNGENTA PARTICIPATIONS AG	211

RESOLUCIONES DE DISEÑOS INDUSTRIALES, DESESTIMADAS

N° Exp	Resolución	Título	Titular	Ag.
No. 4755	24/10/2022	TECHO TEJA METÁLICA	Leopoldo Gioielli Faviere Grisi	
No. 4852	07/10/2022	JUEGO 3 EN LINEA 3D	Gerardo José Maciel Dorrego	

RESOLUCIONES DE PATENTES, DESISTIDAS

N° Exp	Resolución	Título	Titular	Ag.
No. 35121	17/10/2022	MÉTODO DE PRODUCCIÓN EN LINEA DE PROCESO DE FABRICACIÓN DE PAPEL	WETEND TECHNOLOGIES LTD y STORA ENSO OYJ	192

RESOLUCIONES DE PATENTES, ABANDONADAS

N° Exp	Resolución	Título	Titular	Ag.
No. 34321	22/11/2022	CONJUNTO INTEGRADO DE SOPORTE Y MATERIAL COLORANTE PARA EXPRESIÓN PLÁSTICA	LUIS INFANTOZZI	
No. 34417	22/11/2022	PRODUCTO PARA ENCAPSULAR SEMILLAS AGRÍCOLAS-FORRAJERAS	HERNÁN PABLO REGULES SILES	
No. 34837	07/10/2022	MÉTODO PARA GENERACIÓN DE SIMBIOTA A GRAN ESCALA	AGRICULTURE VICTORIA SERVICES PTY LTD	18
No. 35451	07/10/2022	POLVOS DE UREA-FORMALDEHÍDO DE ALTO FLUJO PARA LA FABRICACIÓN DE TABLEROS DE PARTÍCULAS Y TABLEROS DE FIBRAS	GEORGIA-PACIFIC CHEMICALS LLC	216
No. 35646	07/10/2022	ALICATE ALIMENTADO DE ALAMBRE PARA FACILITAR EL ATADO DE PLANTAS A SU SOPORTE	MAYOR FERRARI, Alejandro	34
No. 35767	07/10/2022	INSTALACIÓN Y PROCEDIMIENTO PARA LA PRODUCCIÓN DE ESTERES DE ÁCIDOS GRASOS UTILIZABLES COMO COMBUSTIBLE	SUPERCritical IDEAS, SL	180
No. 35807	07/11/2022	MOLINO DE SUSPENSIÓN TURBINADOS	PABLO GABRIEL DEL RÍO y NICOLÁS YAKOBEZUK CASTRO	
No. 35829	07/11/2022	SISTEMA DE GESTION DE FLOTAS Y GESTIÓN DE ESTACIONES DE SERVICIOS	DISTRIBUIDORA URUGUAYA DE COMBUSTIBLES S.A.	144

N° Exp	Resolución	Título	Titular	Ag.
No. 35836	07/10/2022	ACEITE CORPORAL SABORIZADO, Y PROCESO DE SU ELABORACIÓN	PAULA RAQUEL LUBCHANSKY JERUSALMI	189
No. 35875	24/10/2022	INHIBIDORES DE QUINASA RELACIONADA CON LA TROPOMIOSINA (TRK).	Genzyme Corporation	165
No. 35908	07/11/2022	MODULADORES DE TETRAHIDROPIRIDOPIRAZINAS DE GPR6	Takeda Pharmaceutical Company Limited	94
No. 36506	31/10/2022	PROCESO PARA PROVEER AGUA VISCOSIFICADA PARA INYECCIÓN EN UNA FORMACIÓN PRODUCTORA DE PETRÓLEO SUBTERRÁNEO SUBMARINO E INSTALACIÓN SUBMARINA ASOCIADA	TOTAL S.A.	189
No. 36511	31/10/2022	PROCEDIMIENTO PARA AUTORIZAR ACCESOS DE DIRECCIONAMIENTO A PLANTAS DE ENERGÍA EÓLICA ASÍ COMO INTERFAZ DE PLANTAS DE ENERGÍA EÓLICA Y ENTE DE CERTIFICACIÓN	WOBEN PROPERTIES GMBH	34
No. 36515	31/10/2022	DI-PIDOTIMOD BENZATINA Y SUS FORMAS SÓLIDAS	POLICHEM S.A.	180
No. 36517	31/10/2022	MÉTODO DE APLICACIÓN DE UN VEHÍCULO SÓLIDO EN PARTÍCULAS PARA MEJORAR LA EFICACIA DE UN COMPUESTO AGROQUÍMICO	OMYA INTERNATIONAL AG	20
No. 36520	31/10/2022	PROCEDIMIENTO PARA LA DEFORMACIÓN DE UN CUERPO TUBULAR, DE CUERPOS TUBULARES EN FORMA DE MEANDRO Y EL USO DE ESTOS	WOBEN PROPERTIES GMBH	34
No. 36522	31/10/2022	ULTRACENTRIFUGACIÓN ANALÍTICA PARA LA CARACTERIZACIÓN DE PARTÍCULAS VIRALES RECOMBINANTES	GENZYME CORPORATION	165
No. 36523	31/10/2022	CONJUGADOS DE ÁCIDOS GRASOS Y APELINA SINTÉTICA CON MAYOR VIDA MEDIA	NOVARTIS AG	94
No. 36534	22/11/2022	AEROGENERADOR Y SISTEMA DE COMUNICACIONES DE AEROGENERADOR	WOBEN PROPERTIES GMBH	34
No. 36536	31/10/2022	ANTICUERPOS ANTI-CD3, ANTICUERPOS ANTI-CD123 Y ANTICUERPOS BIESPECÍFICOS QUE SE	SANOFI	165

N° Exp	Resolución	Título	Titular	Ag.
		UNEN ESPECÍFICAMENTE A CD3 Y/O CD123		
No. 36541	31/10/2022	“PROCESO PARA LA FABRICACIÓN DE UNA SOLUCIÓN DE UN HIDRÓGENOCARBONATO ALCALINOTÉRREO”.	OMYA INTERNATIONAL AG	20
No. 36544	31/10/2022	DERIVADOS DE 4H-PIRROL[3,2-C]PIRIDIN-4-ONA	BAYER PHARMA AKTIENGESELLSCHAFT	34
No. 36546	31/10/2022	“CICLOPROPABENZOFURANIL-PIRIDOPIRAZINDIONAS NOVEDOSAS”.	Pfizer Inc	20
No. 36547	31/10/2022	DERIVADOS HETEROCÍCLICOS CONDENSADOS BICÍCLICOS SUSTITUIDOS POR 2-(HET)ARILO COMO PESTICIDAS	Bayer Cropscience Aktiengesellschaft	216
No. 36548	31/10/2022	DERIVADOS HETEROCÍCLICOS CONDENSADOS BICÍCLICOS SUSTITUIDOS POR 2-(HET)ARILO COMO PESTICIDAS	Bayer Cropscience Aktiengesellschaft	216
No. 36551	31/10/2022	2-TIOIMIDAZOLILCARBOXAMIDAS SUSTITUIDAS COMO PESTICIDAS	Bayer Cropscience Aktiengesellschaft	216
No. 36554	07/11/2022	ARNi VARIANTE	GENZYME CORPORATION	165
No. 36555	31/10/2022	COMPOSICIONES FARMACÉUTICAS PARA EL TRATAMIENTO DE LA HIPERTENSIÓN CON BASE EN UNA NUEVA COMBINACIÓN DE FÁRMACOS	INVEKRA, S.A.P.I. DE C.V.	94
No. 36556	07/11/2022	NUEVAS COMPOSICIONES FARMACÉUTICAS PARA EL TRATAMIENTO DE LA HIPERTENSIÓN	INVEKRA, S.A.P.I. DE C.V.	94
No. 36557	31/10/2022	COMPOSICIÓN ÁCIDA A BASE DE LEONARDITA Y AMINOÁCIDOS	Sipcam Inagra, S.A.	136
No. 36559	07/11/2022	DERIVADOS DE 2-DIFLUOROMETILO-NICOTINA TIOCARBOXANILIDA SUSTITUIDOS Y SUS USOS COMO FUNGICIDAS	Bayer Cropscience Aktiengesellschaft	216
No. 36560	07/11/2022	IMPRESIÓN DE INYECCIÓN DE TINTA EN PRODUCTOS DE FIBROCEMENTO	ETERNIT AG	20
No. 36561	07/11/2022	NUEVAS PROTEÍNAS ESPECÍFICAS PARA PIOVERDINA Y PIOQUELINA	SANOFI	165
No. 36562	07/11/2022	METODO PARA LA ADMINISTRACIÓN DE DROGA	OSMOTICA PHARMACEUTICAL ARGENTINA	34

N° Exp	Resolución	Título	Titular	Ag.
			S.A.U.	
No. 36563	07/11/2022	METODO PARA MEJORAR LA TERAPIA CON AGONISTA DEL RECEPTOR GABAB	OSMOTICA PHARMACEUTICAL ARGENTINA S.A.U.	34
No. 36564	07/11/2022	DERIVADOS DE NUCLEÓSIDOS SUSTITUIDOS ÚTILES COMO AGENTES ANTINEOPLÁSICOS	Pfizer Inc.	20
No. 36565	31/10/2022	VARIANTES DE POLIPÉPTIDOS QUE DIVIDEN TOXINAS DE FUSARIUM, ADITIVO QUE CONTIENE ESTAS VARIANTES Y SU USO, ASI COMO PROCEDIMIENTOS PARA LA DIVISION DE TOXINAS DE FUSARIUM	Erber Aktiengesellschaft	136
No. 36566	07/11/2022	COMPUESTOS HERBICIDAS	SYNGENTA PARTICIPATIONS AG	20
No. 36567	07/11/2022	FORMA DE DOSIFICACIÓN DE LIBERACIÓN CONTROLADA	OSMOTICA PHARMACEUTICAL ARGENTINA S.A.U.	34
No. 36568	31/10/2022	FORMA DE DOSIFICACIÓN DE LIBERACIÓN CONTROLADA CON FARMACOCINÉTICA MEJORADA	OSMOTICA PHARMACEUTICAL ARGENTINA S.A.U	34
No. 36569	07/11/2022	COMPOSICIONES PARA USO EN EL TRATAMIENTO DE DIARREA Y EN LA PROMOCIÓN DE LA SALUD INTESTINAL EN ANIMALES NO HUMANOS	JAGUAR HEALTH, INC.	34
No. 36571	07/11/2022	COMBINACIONES DE COMPUESTOS ACTIVOS	Bayer Cropscience Aktiengesellschaft	216
No. 36574	07/11/2022	INHIBIDORES DE BROMODOMINIOS	GlaxoSmithKline Intellectual Property (No.2) Limited	165
No. 36577	07/11/2022	COMPUESTOS MODULADORES DE RECEPTOR DE TIPO TOLL	GILEAD SCIENCES, INC.	94
No. 36579	07/11/2022	COMPOSICIONES Y MÉTODOS PARA ACTIVAR LA SEÑALIZACIÓN DEPENDIENTE DEL “ESTIMULADOR DEL GEN INTERFERON.	ADURO BIOTECH, INC.	94
No. 36582	07/11/2022	MOLÉCULAS DE ÁCIDO NUCLEICO DE II33 DE ARN POLIMERASA PARA EL CONTROL DE PLAGAS DE INSECTOS	DOW AGROSCIENCES LLC y FRAUNHOFER-GESELLSCHAFT ZUR FÖRDERUNG DERANGEWANDTEN FORSCHUNG EV	20
No. 36583	07/11/2022	MOLÉCULAS DE ÁCIDO NUCLEICO DE II215 DE ARN POLIMERASA PARA EL CONTROL DE PLAGAS DE INSECTOS	DOW AGROSCIENCES LLC y FRAUNHOFER-GESELLSCHAFT ZUR FÖRDERUNG DERANGEWANDTEN FORSCHUNG EV	20

N° Exp	Resolución	Título	Titular	Ag.
No. 36584	07/11/2022	PROCEDIMIENTO Y DISPOSITIVO PARA FABRICAR UNA PIEZA PRECONFORMADA	WOBEN PROPERTIES GMBH	34
No. 36585	07/11/2022	PROCESO DE PREPARACIÓN	BAYER PHARMA AKTIENGESELLSCHAFT	216
No. 36586	07/11/2022	HETEROCICLILMETILTENOURACILOS Y USO DE LOS MISMOS	BAYER PHARMA AKTIENGESELLSCHAFT	216
No. 36589	07/11/2022	COMPUESTOS QUÍMICOS	GlaxoSmithKline Intellectual Property Development Limited	165
No. 36590	07/11/2022	USO DE DESHIDROGENASA ALCOHOLICA TRANSFORMADORA DE UN TRICOTECENO, METODO PARA LA TRANSFORMACIÓN DE TRICOTECENOS Y ADITIVO TRANSFORMADOR DE TRICOTECENOS	Erber Aktiengesellschaft	136
No. 36591	07/11/2022	PROCESO PARA PRODUCIR MATERIAL RECUBIERTO POR EXTRUSIÓN, DICHO MATERIAL RECUBIERTO, ARTÍCULO DE DICHO MATERIAL Y USO DE DICHO MATERIAL	OMYA INTERNATIONAL AG	20
No. 36592	07/11/2022	PROCEDIMIENTO PARA EL CONTROL DE UN GENERADOR SÍNCRONO DE UNA INSTALACIÓN DE ENERGÍA EÓLICA SIN ENGRANAJES	WOBEN PROPERTIES GMBH	34
No. 36595	07/11/2022	FORMULACIÓN COMPLEJA FARMACÉUTICA QUE COMPRENDE AMLODIPINA, LOSARTÁN Y CLORTALIDONA	HANMI PHARM. CO., LTD.	20
No. 36597	07/11/2022	COMPOSICIÓN DE RECUBRIMIENTO ACUOSA PARA RECUBRIMIENTOS ESTIRABLES EN APLICACIONES DE PAPEL Y CARTÓN, Y SU USO	OMYA INTERNATIONAL AG	20
No. 36603	07/11/2022	NUEVOS DERIVADOS DE IMIDAZOLILMETILO 5-SUSTITUIDOS	BAYER CROPSCIENCE AKTIENGESELLSCHAFT	34
No. 36604	07/11/2022	DERIVADOS DE TRIAZOL NOVEDOSOS	BAYER CROPSCIENCE AKTIENGESELLSCHAFT	34
No. 36605	07/11/2022	DERIVADOS DE TRIAZOL NOVEDOSOS	BAYER CROPSCIENCE GMBH	34
No. 36607	07/11/2022	MEZCLAS HERBICIDAS	SYNGENTA PARTICIPATIONS AG	20
No. 36609	07/11/2022	DERIVADOS HETEROCÍCLICOS BICÍCLICOS CONDENSADOS COMO PESTICIDAS	Bayer Cropscience Aktiengesellschaft	216

N° Exp	Resolución	Título	Titular	Ag.
No. 36611	07/11/2022	PRODUCCIÓN DE VECTORES ADENO-ASOCIADOS DE GRAN TAMAÑO	GENZYME CORPORATION	165
No. 36612	07/11/2022	COMPUESTOS DE QUINAZOLINA SUSTITUIDOS Y MÉTODOS DE USO DE LOS MISMOS.	ARAXES PHARMA LLC	165
No. 36613	07/11/2022	PALA DE ROTOR DE INSTALACIÓN DE ENERGÍA EÓLICA	WOBEN PROPERTIES GMBH	34
No. 36614	07/11/2022	INSTALACIÓN DE ENERGÍA EÓLICA CON CIRCUITO DE CIRCULACIÓN DE LÍQUIDO Y COMPONENTES PARA ELLA	WOBEN PROPERTIES GMBH	34
No. 36615	07/11/2022	EQUIPAMIENTO DE REGULACIÓN PARA REGULAR UNA PALA DE ROTOR DE UNA INSTALACIÓN DE ENERGÍA EÓLICA	WOBEN PROPERTIES GMBH	34
No. 36616	07/11/2022	FUSIONES DE VARIANTE III DEL RECEPTOR DE FACTOR DE CRECIMIENTO EPIDÉRMICO-MESOTELINA Y MÉTODOS PARA USAR LOS MISMOS	Aduro Biotech, Inc.	136
No. 36617	07/11/2022	PROTEÍNAS DE FUSIÓN INMUNOGÉNICAS PARA EL TRATAMIENTO DEL CÁNCER	Aduro Biotech, Inc. y The Johns Hopkins University	136
No. 36620	07/11/2022	MÉTODO PARA LA ACETILACIÓN DE LA MADERA	Tricoya Technologies Ltd.	20
No. 36622	14/11/2022	INSTALACIÓN DE ENERGÍA EÓLICA Y PAQUETE POLAR PARA UN GENERADOR SÍNCRONO DE UNA INSTALACIÓN DE ENERGÍA EÓLICA COMO TAMBIÉN GENERADOR SÍNCRONO	WOBEN PROPERTIES GMBH	34
No. 36624	14/11/2022	GUÍA DE CABLE TENSOR EN UNA TORRE DE UNA INSTALACIÓN DE ENERGÍA EÓLICA	WOBEN PROPERTIES GMBH	34
No. 36625	14/11/2022	PROCEDIMIENTO PARA DETERMINAR UNA VIDA ÚTIL REMANENTE DE UNA INSTALACIÓN DE ENERGÍA EÓLICA	WOBEN PROPERTIES GMBH	34
No. 36626	14/11/2022	PROMOTOR DE PLANTAS PARA EXPRESIÓN TRANSGÉNICA	DOW AGROSCIENCES LLC	20

N° Exp	Resolución	Título	Titular	Ag.
No. 36627	14/11/2022	PROMOTOR DE PLANTAS PARA EXPRESIÓN TRANSGÉNICA	DOW AGROSCIENCES LLC	20
No. 36629	14/11/2022	INDAZOLONAS COMO MODULADORES DE LA SEÑALIZACIÓN DE TNF	AbbVie Inc.	218
No. 36634	14/11/2022	MEZCLA DE PARTÍCULAS CON CARBONATO DE CALCIO DE SUPERFICIE MODIFICADA Y PARTÍCULAS CON CARBONATO DE CALCIO PRECIPITADO Y SUS USOS	OMYA INTERNATIONAL AG	20
No. 36639	14/11/2022	EXTRACTOR DE MUESTRAS DE BIOPSIA Y RECOLECTOR DE MUESTRAS	SNPSHOT TRUSTEE LIMITED	94
No. 36640	14/11/2022	RECIPIENTE DE ALMACENAMIENTO DE MUESTRAS DE BIOPSIA Y EXTRACTOR DE MUESTRAS RELACIONADO	SNPSHOT TRUSTEE LIMITED	94
No. 36641	14/11/2022	UN RECOLECTOR DE BIOPSIAS CON IDENTIFICADOR	SNPSHOT TRUSTEE LIMITED	94
No. 36642	14/11/2022	UN RECOLECTOR DE BIOPSIAS	SNPSHOT TRUSTEE LIMITED	94
No. 36645	14/11/2022	PRENSA DE TIPO TAMBOR Y MÉTODO PARA EXTRAER LÍQUIDO DE CORTEZAS	Andritz Oy	216
No. 36646	14/11/2022	MATERIAL DE RELLENO A BASE DE MINERALES MODIFICADOS QUE COMPRENDE SALES DE COBRE	Omya International AG	216
No. 36651	14/11/2022	COMPUESTOS ANTIESTROGÉNICOS	Pfizer Inc.	20
No. 36652	14/11/2022	COMBINACIONES ANTIPARASÍTICAS	Bayer Animal Health GmbH	216
No. 36656	14/11/2022	FENIL-DIONAS SUSTITUIDAS CON HETEROARILMETOXI/HETEROCICLILMETOXI Y DERIVADOS DE FENIL-DIOXO-TIAZINONA SUSTITUIDOS CON HETEROARILMETOXI/HETEROCICLILMETOXI HERBICIDAS	SYNGENTA PARTICIPATIONS AG	20
No. 36657	14/11/2022	HERBICIDAS DERIVADOS DE HETEROARILO/FENILO SUSTITUIDOS CON HETEROARILALQUIL-OXI	SYNGENTA PARTICIPATIONS AG	20

N° Exp	Resolución	Título	Titular	Ag.
No. 36658	14/11/2022	FENIL DIONAS BENCILOXI-SUSTITUIDA HERBICIDAS Y DERIVADOS DE FENIL-DIOXO- TIAZINONA BENCILOXI-SUSTITUIDA	SYNGENTA PARTICIPATIONS AG	20
No. 36660	14/11/2022	COMBINACIONES DE INHIBIDORES DE IRAK4	BAYER PHARMA AKTIENGESELLSCHAFT	34
No. 36663	14/11/2022	ANTICUERPOS ANTI-AP2 Y AGENTES DE UNIÓN AL ANTÍGENO PARA TRATAR TRASTORNOS METABÓLICOS	UCB Biopharma SPRL y President and Fellows of Harvard College	216
No. 36664	14/11/2022	PROCEDIMIENTO PARA LA PREPARACIÓN DE 2-{4-[2- ({[2-(4-CLOROFENIL)-1,3-TIAZOL-4- IL]METIL}SULFANIL)-3,5-DICIANO-6-(PIRROLIDIN-1- IL)PIRIDINA-4-IL]FENOXI}ETIL-L-ALANIL-L- ALANINATO-MONOHIDROCLORURO	BAYER PHARMA AKTIENGESELLSCHAFT	216
No. 36665	14/11/2022	DERIVADOS DE CICLOHEXANO SUSTITUIDOS CON AMIDAS	Bayer Pharma Aktiengesellschaft	216
No. 36667	14/11/2022	PROCESO MEJORADO PARA LA PREPARACIÓN DE COMPUESTOS ANFIFÍLICOS DE IMIDAZOLINIO	Bayer Animal Health GmbH	216
No. 36669	14/11/2022	ROTOR PARA UNA INSTALACIÓN DE ENERGÍA EÓLICA SIN ENGRANAJES	WOBEN PROPERTIES GMBH	34
No. 36675	14/11/2022	COMPUESTOS CÍCLICOS QUE TIENEN UNA ACCIÓN INHIBIDORA DE LA SEÑALIZACIÓN DEL RECEPTOR DE TIPO TOLL 4 (TLR4)	Takeda Pharmaceutical Company Limited	94
No. 36678	14/11/2022	ANTICUERPOS ANTI-FCRN.	UCB Biopharma SPRL	165
No. 36681	14/11/2022	DISPOSICIÓN DE MEDICIÓN EN UNA INSTALACIÓN DE ENERGÍA EÓLICA	WOBEN PROPERTIES GMBH	34
No. 36685	14/11/2022	MOLÉCULAS DE ACIDO NUCLEICO THREAD QUE CONFIEREN RESISTENCIA A PLAGAS DE HEMÍPTEROS	DOW AGROSCIENCES LLC	20
No. 36686	14/11/2022	DISPOSITIVO PARA COMPACTAR LÁMINAS O DISCOS DE PULPA APILADOS	ANDRITZ AG	34
No. 36690	14/11/2022	MOLÉCULAS DE ÁCIDO NUCLEICO DE SPT6 PARA CONTROLAR PLAGAS DE INSECTOS	DOW AGROSCIENCES LLC y FRAUNHOFER- GESELLSCHAFT ZUR FÖRDERUNG	20

N° Exp	Resolución	Título	Titular	Ag.
			DERANGEWANDTEN FORSCHUNG EV	
No. 36691	14/11/2022	MOLÉCULAS DE ÁCIDO NUCLEICO DE SPT5 PARA CONTROLAR PLAGAS DE INSECTOS	DOW AGROSCIENCES LLC y FRAUNHOFER-GESELLSCHAFT ZUR FÖRDERUNG DERANGEWANDTEN FORSCHUNG EV	20
No. 36693	14/11/2022	TORRE DE INSTALACIÓN DE ENERGÍA EÓLICA	WOBLEN PROPERTIES GMBH	34
No. 36700	14/11/2022	UN DISPOSITIVO DE ENCENDIDO MEJORADO	CLEAN BURN INNOVATIONS LIMITED	156
No. 36701	22/11/2022	TRATAMIENTO CONTRA EL CÁNCER POR MANIPULACIÓN DE LA MICROFLORA COMENSAL	The University of Chicago	20
No. 36702	14/11/2022	PIRIDINAS SUSTITUIDAS Y MÉTODOS DE USO	AbbVie S.á.r.l. y Galapagos NV	218
No. 36703	14/11/2022	COMPOSICIONES Y MÉTODOS PARA LA ADMINISTRACIÓN DE UN POLINUCLEÓTIDO EN UNA PLANTA	Monsanto Technology LLC	20
No. 36706	14/11/2022	ANTICUERPOS DIRIGIDOS A LA PROTEÍNA MORFOGENÉTICA ÓSEA 9 (BMP9) Y MÉTODOS A PARTIR DE ESTOS	NOVARTIS AG	94
No. 36708	14/11/2022	MODULADORES DE ROR GAMMA (ROR _γ)	SANOFI y Lead Pharma Cel Models IP B.V.	165
No. 36709	14/11/2022	MODULADORES DE ROR GAMMA (ROR _γ)	Lead Pharma Cel Models IP B.V. y SANOFI	165
No. 36713	14/11/2022	TRIAZOLES PARA EL TRATAMIENTO DE ENFERMEDADES DESMIELINIZANTES	VERTEX PHARMACEUTICALS INCORPORATED	165
No. 36714	14/11/2022	MODULADORES ALOSTÉRICOS POSITIVOS DEL RECEPTOR MUSCARÍNICO M2	BAYER PHARMA AKTTIENGESELLSCHAFT	216
No. 36717	14/11/2022	PROCESO Y SISTEMA DE IDENTIFICACIÓN DE PRODUCTOS EN DESPLAZAMIENTO EN UNA LÍNEA DE PRODUCCIÓN	VALID SOLUÇÕES E SERVIÇOS DE SEGURANÇA EM MEIOS DE PAGAMENTO E IDENTIFICAÇÃO S.A.	34
No. 36719	14/11/2022	RECIPIENTE A PRUEBA DE NIÑOS Y PROCESO PARA SU CREACIÓN	I.G.B. S.r.l.	34
No. 36720	14/11/2022	USO DEL CARBONATO DE CALCIO TRATADO MEDIANTE REACCIÓN SUPERFICIAL COMO AGENTE ANTI BLOQUEADOR	Omya International AG	216
No. 36722	14/11/2022	COMPOSICIÓN DE PÉPTIDOS MÚLTIPLES.	King's College London	165
No. 36724	14/11/2022	FORMULACIÓN BIOCIDA PARA PROTEGER LA PIEL	BIOGENESIS ANIMAL HEALTH	180

N° Exp	Resolución	Título	Titular	Ag.
		QUE COMPRENDE SALES DE COBRE PENTAHIDRATADO Y SALES DE ZINC HEPTAHIDRATADO		
No. 36725	14/11/2022	CONMUTADOR LONGITUDINAL, PARA SISTEMA DE CAMBIO DE POSICION Y TRABAMIENTO EN EL CONTACTO ELÉCTRICO	RIOTRAFO LTDA.	212
No. 36730	14/11/2022	FENOXIFENILAMIDINAS SUSTITUIDAS CON HALÓGENO Y EL USO DE ESTAS COMO FUNGICIDAS	Bayer Cropscience Aktiengesellschaft	211
No. 36731	14/11/2022	PROTEINAS DE UNIÓN CONTRA VEGF, PDGF, Y/O SUS RECEPTORES	AbbVie Inc.	218
No. 36732	22/11/2022	PIRIDIN PIRAZINONAS NOVEDOSAS COMO INHIBIDORES DE BROMODOMINIOS DE LA FAMILIA BET	Pfizer Inc.	20
No. 36762	22/11/2022	MODIFICACIÓN CRISTALINA TERMODINÁMICAMENTE ESTABLE DE 2-20 CLORO-3-(METILSULFANIL)-N-(1-METIL-1H-TETRAZOL-5-IL)-4-(TRIFLUOROMETIL)BENZAMIDA	BAYER CROPSCIENCE AKTIENGESELLSCHAFT	34
No. 36765	22/11/2022	KIT DOSIFICADOR PARA PRODUCTOS GRANULADOS, PARA MONTAR EN MAQUINARIA	CARLOS HARTWICH	34
No. 36810	22/11/2022	TERMOGRAFÍA INFRARROJA AÉREA PARA USAR EN EL CONTROL DE LA SALUD Y EL CRECIMIENTO DE LAS PLANTAS	AirScout International, Inc.	211
No. 36844	22/11/2022	DERIVADOS HETEROCÍCLICOS CONDENSADOS SUSTITUIDOS POR 2-(het)ARILO COMO PESTICIDAS	BAYER CROPSCIENCE AKTIENGESELLSCHAFT	216
No. 36846	22/11/2022	USO DE ANEXINA PARA MEJORAR EL RENDIMIENTO EN CONDICIONES DE ESTRÉS EN PLANTAS	BAYER CROPSCIENCE NV	34
No. 36849	22/11/2022	CONJUGADOS TERAPÉUTICOS DE INTERNALIZACIÓN CELULAR	CITY OF HOPE	34
No. 36851	22/11/2022	COMPUESTOS PARA USO EN APLICACIONES ANTIBACTERIANAS	GlaxoSmithKline Intellectual Property Development Limited	165
No. 36852	22/11/2022	DERIVADOS DE TRIAZOL NOVEDOSOS	BAYER CROPSCIENCE AG	34

N° Exp	Resolución	Título	Titular	Ag.
No. 36853	22/11/2022	PROMOTOR DE VEGETALES Y UTR 3° PARA EXPRESIÓN TRANSGÉNICA	DOW AgroSciences LLC	20
No. 36871	22/11/2022	TRANSFERENCIA DE DATOS DE INSTALACIONES DE ENERGÍA EÓLICA Y PARQUES EÓLICOS A UNA CENTRAL DE CONTROL	WOBLEN PROPERTIES GMBH	34
No. 36875	22/11/2022	COMPOSICIONES INHIBIDORAS DE BROMODOMINIOS PARA EL TRATAMIENTO DE DIVERSAS ENFERMEDADES	GlaxoSmithKline Intellectual Property (No.2) Limited	165
No. 36879	22/11/2022	MOLÉCULAS CON UTILIDAD PESTICIDA Y PRODUCTOS INTERMEDIOS, COMPOSICIONES Y PROCESOS RELACIONADOS A ELLAS	DOW AGROSCIENCES LLC	20
No. 39232	17/10/2022	COMPUESTOS, COMPOSICIONES Y MÉTODOS PARA INHIBIR LA LEUCEMIA DE LINAJE MIXTO 1 (MLL1)	NOVARTIS AG	211
No. 39447	17/10/2022	ACONDICIONADOR PARA MASAS DE PRODUCTOS DE PANADERÍA HORNEADOS Y OTROS, QUE SUSTITUYE EL CONTENIDO GRASO DE ESTOS Y PROCESO DE ELABORACIÓN DEL MISMO	PRODIA S.A.S.	94
No. 39652	17/10/2022	PROTEÍNAS Y METABOLITOS BIOMARCADORES EN SANGRE PARA EL DIAGNÓSTICO DEL SÍNDROME DE BRUGADA	CARDIOMIX S.r.l.	216
No. 39704	31/10/2022	COMPOSICIONES DE PSILOCIBINA, PROCEDIMIENTOS DE FABRICACIÓN Y PROCEDIMIENTOS DE USO DE LAS MISMAS	COMPASS Pathfinder Limited	34
No. 39746	14/11/2022	MAGAZÍN DE ÍTEMS DE ELECTRIFICACIÓN, VEHÍCULO DE TRANSPORTE COLECTIVO Y PROCESO DE MONTAJE DE MAGAZÍN	MARCOPOLO S.A.	94
No. 39747	14/11/2022	ESTRUCTURA PARA BALANCE TRASERO DE VEHÍCULO DE TRANSPORTE COLECTIVO Y PROCESO DE FABRICACIÓN DE ESTRUCTURA PARA BALANCE TRASERO DE VEHÍCULO DE TRANSPORTE COLECTIVO	MARCOPOLO S.A.	94

N° Exp	Resolución	Título	Titular	Ag.
No. 39748	14/11/2022	CONJUNTO DE ALMACENAMIENTO DE ÍTEMS DE ELECTRIFICACIÓN, VEHÍCULO DE TRANSPORTE COLECTIVO Y PROCESO DE MONTAJE DEL CONJUNTO EN EL VEHÍCULO	MARCOPOLO S.A.	94
No. 39749	14/11/2022	CONJUNTO ESTRUCTURAL DE CARROCERÍA Y CHASIS PARA LA REGIÓN DE PUESTO DEL CHOFER, VEHÍCULO DE TRANSPORTE COLECTIVO Y PROCESO DE FABRICACIÓN DEL VEHÍCULO	MARCOPOLO S.A.	94
No. 39824	17/10/2022	COMPOSICIÓN DE GLIFOSATO PARA MEZCLAS DE TANQUE CON DICAMBA CON VOLATILIDAD MEJORADA	Monsanto Technology LLC	211

En virtud de la discrepancia que surge en la actualidad entre la fecha de validez de las resoluciones en los sistemas IPAS y [PAMP](#) con la que surge del Boletín de la DNPI, debe dejarse constancia que la fecha de validez de la resolución correspondiente es la que surge de los sistema IPAS y [PAMP](#), fecha de firma de la misma.

NOTIFICACIONES DE ASESORÍA

De conformidad con lo establecido por el numeral 4° del artículo 80 de la Ley 17.011 del 25 de setiembre de 1998 y artículo 87 del decreto N° 34/999 del 3 de febrero de 1999, se notifica a quien se cita a continuación, por razones de su interés, debe presentarse en sección Recursos de la Dirección Nacional de Propiedad Industrial, sita en la calle Rincón 723, 3er. Piso.

MARCA	URUGUAY ARGENTINA 2030
ACTA	440892
NOMBRE	SCASSO VOLONTE ALBERTO MARTIN
NOTIFICACION	<p>Expediente: Marca Nro. 440892 Signo: URUGUAY ARGENTINA 2030 Titular: SCASSO VOLONTE ALBERTO MARTIN Clase(s): 9, 16, 25, 38, 42 y 43</p> <p style="text-align: right;">Montevideo, 8 de julio de 2022</p> <p>De acuerdo con el dictamen de la División Legal del día de la fecha se confiere vista a las partes por el término de diez días hábiles, perentorios e improrrogables, conforme artículo 16 del Decreto 34/999 del 3/2/999.</p>

MARCA	ECO BOLA
ACTA	489071
NOMBRE	EDALSIR SOCIEDAD ANONIMA
NOTIFICACION	<p>VISTO: La solicitud de Registro de la Marca ECO BOLA, presentada bajo expediente No. 489071 a favor de EDALSIR SOCIEDAD ANONIMA de URUGUAY, para distinguir los productos y servicios comprendidos en las Clases internacionales 21, 35 y 38.</p> <p>RESULTANDO: I) Contra dicha solicitud se dedujo oposición respecto a la clase 35 por SUPERMERCADOS DISCO DEL URUGUAY S.A. II) División Legal dictamina que correspondería CONCEDER el presente registro por los argumentos que expone en su dictamen. III) El Encargado de Área Asuntos Jurídicos comparte lo dictaminado por su Asesor actuante.</p> <p>CONSIDERANDO: que esta Dirección, de conformidad con lo dictaminado por su División Legal, resolverá en consecuencia.</p> <p>ATENTO: a lo expuesto, a lo que establecen la Ley de Marcas No 17.011 de 25 de setiembre de 1998, su Decreto Reglamentario No. 34/999 de 3 de febrero de 1999 y disposiciones modificativas.</p> <p style="text-align: center;">LA DIRECCION NACIONAL DE LA PROPIEDAD INDUSTRIAL</p> <p style="text-align: center;">RESUELVE:</p> <p>1°.- CONCÉDESE el Registro de la Marca ECO BOLA, por el conjunto, sin derechos privativos sobre el término ECO en las clases</p>

	<p>internacionales 21, 35 y 38, y sin derechos privativos sobre el término BOLA, en las clases internacionales 21 y 35, artículo 7 de la ley 17.011, solicitado bajo expediente No. 489071 a favor de EDALSIR SOCIEDAD ANONIMA de URUGUAY, para distinguir los productos y servicios comprendidos en las Clases internacionales 21, 35 y 38.</p> <p>2°.- NOTIFÍQUESE, publíquese, efectúense las anotaciones de estilo, Página 2 de 2 entréguese el título bajo recibo y oportunamente archívese</p>
--	--

MARCA	BENEFITNESS
ACTA	489680
NOMBRE	INICIATIVA MAGENTA SRL
NOTIFICACION	<p>Expediente: Marca Nro. 489680 Signo: BENEFITNESS (mixta) Titular: INICIATIVA MAGENTA SRL Clase(s): 35 y 41</p> <p style="text-align: right;">Montevideo, 21 de octubre de 2022</p> <p>De acuerdo con el dictamen previo de la División Legal se confiere vista de lo actuado por el término de diez días hábiles, perentorios e improrrogables, conforme artículo 16 del Decreto 34/999 del 3/2/999.</p>

MARCA	LOOM
ACTA	454284
NOMBRE	JAVIER SAUL SABAH ALALUF KARINA SABAH
NOTIFICACION	<p>VISTO: La solicitud de registro de la Marca LOOM, <i>mixta</i>, presentada bajo expediente No. 454284 a favor de JAVIER SAUL SABAH ALALUF de URUGUAY y KARINA SABAH de URUGUAY, para distinguir los productos y servicios comprendidos en las Clases internacionales 28, 35 y 41, respectivamente.</p> <p>RESULTANDO: I) Se dedujeron oposiciones por: a) Choon's Design Inc. de los EUA, respecto de las tres Clases solicitadas, fundada en el riesgo de confusión con su marca RAINBOW LOOM, No. 456183, y en lo establecido en el artículo 5 numerales 6 y 7 de la Ley 17011; y b) Fruit of the Loom, Inc. de los EUA, solamente respecto de la Clase 35, fundada en el riesgo de confusión con sus marcas FRUIT OF THE LOOM, Nos. 368429, 373774, 389998, 395214, 424263, 424264, 424265, 424266 y 437581, y en lo dispuesto por el artículo 5 numerales 6 y 7 de la Ley 17011.</p> <p>II) División Legal, en su dictamen del 20 de octubre de 2022 informa que la primera oposición no es de recibo, pues la solicitud de registro No. 456183 es posterior a la presente y por ende no resulta oponible, y tampoco se ha presentado en forma la prueba. Sin perjuicio de ello, y por los fundamentos que en el mismo se explicitan, aconseja amparar la segunda oposición, teniendo por acreditada la notoriedad de sus marcas y trayectoria empresarial, el probable riesgo de asociación y por ende, de competencia desleal, y en su mérito aconseja desestimar el registro para la Clase internacional 35, sin perjuicio de</p>

	<p>CONCEDERLO PARCIALMENTE para las Clases 28 y 41.</p> <p>III) La Encargada de Área Asuntos Jurídicos, en su informe del 21 de octubre de 2022, comparte lo dictaminado por su Asesor actuante.</p> <p>CONSIDERANDO: que esta Dirección, de conformidad con los dictámenes precedentes, resolverá en consecuencia.</p> <p>ATENTO: a lo expuesto, a lo que establecen la Ley de Marcas No 17.011 de 25 de septiembre de 1998, su Decreto Reglamentario No. 34/999 de 3 de febrero de 1999 y disposiciones modificativas.</p> <p style="text-align: center;">LA DIRECCION NACIONAL DE LA PROPIEDAD INDUSTRIAL</p> <p style="text-align: center;">RESUELVE</p> <p>1°.- CONCÉDESE el registro de la Marca <i>LOOM, mixta</i>, solicitada bajo expediente No. <i>454284</i> a favor de <i>JAVIER SAUL SABAH ALALUF de URUGUAY</i> y <i>KARINA SABAH de URUGUAY</i>, para distinguir los productos y servicios comprendidos en las Clases internacionales <i>28 y 41</i>.</p> <p>2°.- DESESTÍMASE el registro de la Marca <i>LOOM, mixta</i>, solicitada bajo expediente No. <i>454284</i> a favor de <i>JAVIER SAUL SABAH ALALUF de URUGUAY</i> y <i>KARINA SABAH de URUGUAY</i>, para distinguir los servicios comprendidos en la Clase internacional <i>35</i>.</p> <p>3°.- NOTIFÍQUESE, publíquese, efectúense las anotaciones de estilo, entréguese el título bajo recibo y oportunamente archívese.- acr</p>
--	--

MARCA	GIOIELLI DI CRISTALLO
ACTA	401009
NOMBRE	MAYDA PADRÓN
NOTIFICACION	<p>VISTO La solicitud de Registro de la Marca <i>GIOIELLI DI CRISTALLO</i>, solicitada bajo expediente No. <i>401009</i> a favor de <i>MAYDA PADRÓN</i>, para distinguir los artículos/servicios comprendidos en la/s clase/s internacional/es <i>14</i>.</p> <p>CONSIDERANDO: lo anteriormente informado.</p> <p>ATENTO: a lo dispuesto en los artículos 4 y 21 de la Ley N° 17 .O 11 de fecha 25 de setiembre de 1998 y en el artículo 188 de la Ley N° 17.930 de fecha 19 de diciembre de 2005.</p> <p style="text-align: center;">LA DIRECCIÓN NACIONAL DE LA PROPIEDAD INDUSTRIAL</p> <p style="text-align: center;">RESUELVE:</p> <p>1°. Dedúcese oposición de oficio a la solicitud de Registro de Marca <i>GIOIELLI DI CRISTALLO</i> solicitada bajo expediente No. <i>401009</i> a favor de <i>MAYDA PADRÓN de URUGUAY</i> en base a lo dispuesto en el Art. 4 precitado incisos 1 0°), 11 °) y 12°).</p> <p>2°. De la oposición de oficio deducida y de acuerdo a lo "Decreto N' 34/999, vista al solicitante por el término de 30 días corridos y perentorios</p>

MARCA	AROMA´S,
ACTA	489356
NOMBRE	RUBEN MARCOS CASTRO DO SANTOS
NOTIFICACION	<p>VISTO: La solicitud de registro de la Marca <i>AROMA´S, mixta</i>, presentada bajo expediente No. 489356 a favor de <i>RUBEN MARCOS CASTRO DO SANTOS de URUGUAY</i>, para distinguir los productos comprendidos en las Clases internacionales 3 y 5.</p> <p>RESULTANDO: I) Se dedujeron dos oposiciones de terceros, a) Por Taz Limitada, fundada en la confundibilidad con sus registros ESPACIO AROMA No. 380296 y E A ESPACIO AROMA No. 417663, que tutelan Clases 3 y 5, invocando también sus registros ESPACIO AROMA, Nos. 480073 y 434034, para Clases 11 y 35, la trayectoria de su establecimiento en nuestro país y en Lima-Perú; y b) Por Osvaldo Daniel Delillo, sólo respecto de la Clase 3, fundada en la confundibilidad con su registro AROMASS AIR BREEZE, No. 446943, para la misma Clase.</p> <p>II) División Legal, por los fundamentos expuestos en su dictamen del 3 de noviembre de 2022 informa que las oposiciones no son de recibo y que entre los signos en pugna se cumplen las diferencias requeridas legalmente, por lo cual aconseja desestimar las mismas y CONCEDER el registro solicitado, aunque por el conjunto y sin derechos privativos sobre el término AROMA.</p> <p>III) La Encargada de Área Asuntos Jurídicos, en su informe del 4 de noviembre de 2022, comparte lo dictaminado por su Asesor actuante.</p> <p>CONSIDERANDO: que esta Dirección, de conformidad con los dictámenes precedentes, resolverá en consecuencia.</p> <p>ATENTO: a lo expuesto, a lo que establecen la Ley de Marcas No 17.011 de 25 de septiembre de 1998, su Decreto Reglamentario No. 34/999 de 3 de febrero de 1999 y disposiciones modificativas.</p> <p style="text-align: center;">LA DIRECCION NACIONAL DE LA PROPIEDAD INDUSTRIAL</p> <p style="text-align: center;">RESUELVE</p> <p>1°.- CONCÉDESE el Registro de la Marca <i>AROMA´S, mixta</i>, solicitada bajo expediente No. 489356 a favor de <i>RUBEN MARCOS CASTRO DO SANTOS de URUGUAY</i>, para distinguir los productos comprendidos en la Clases internacionales 3 y 5, por el conjunto y sin derechos privativos sobre el término “AROMA”, de acuerdo al artículo 7 de la Ley No. 17011 de 25/9/1998. .</p> <p>2°.- NOTIFÍQUESE, publíquese, efectúense las anotaciones de estilo, entréguese el título bajo recibo y oportunamente archívese.- acr</p>
MARCA	DOÑA PETRONA
ACTA	452229
NOMBRE	GABRIEL NICOLAS DEVIA IBARRA
NOTIFICACION	<p>VISTO: La solicitud de Registro de la Marca <i>DOÑA PETRONA</i>, presentada bajo expediente No. 452229 a favor de <i>GABRIEL NICOLAS DEVIA IBARRA de URUGUAY</i>, para distinguir los</p>

	<p>productos comprendidos en las Clases internacionales 29 y 30.</p> <p>RESULTANDO: I) Se dedujo oposición por el Área de Signos Distintivos, por entender que la solicitud encuadra en la causal de nulidad relativa prevista en el artículo 5 numeral 3° de la Ley No. 17.011 de 25/9/998.</p> <p>II) División Legal, en su dictamen del 11 de noviembre de 2022, informa que la marca se pretende para distinguir productos alimenticios, vinculados a la gastronomía, resulta un hecho notorio la existencia de la Sra. Petrona Carrizo de Gandulfo, conocida como “Doña Petrona”, y para sortear la prohibición prevista en la precitada disposición se requería la conformidad de la titular o sus herederos, pero ello no ocurrió, por lo cual aconseja mantener la oposición y DESESTIMAR la presente gestión.</p> <p>III) La Encargada de Área Asuntos Jurídicos, en informe del 16 de noviembre de 2022, comparte lo dictaminado por su Asesor actuante.</p> <p>CONSIDERANDO: que esta Dirección, de conformidad con los dictámenes precedentes, resolverá en consecuencia.-</p> <p>ATENTO: a lo expuesto, a lo que establecen la Ley de Marcas No 17.011 de 25 de setiembre de 1998, su Decreto Reglamentario No. 34/999 de 3 de febrero de 1999 y disposiciones modificativas.-</p> <p style="text-align: center;">LA DIRECCION NACIONAL DE LA PROPIEDAD INDUSTRIAL</p> <p style="text-align: center;">R E S U E L V E</p> <p>1°.- DESESTÍMASE la solicitud de Registro de Marca DOÑA PETRONA, presentada bajo expediente No. 452229 a nombre de GABRIEL NICOLAS DEVIA IBARRA de URUGUAY, para distinguir los productos comprendidos en las Clases internacionales 29 y 30.</p> <p>2°.- NOTIFÍQUESE, publíquese, efectúense las anotaciones de estilo y oportunamente archívese.</p> <p>acr</p>
--	--

ARCA	URUGUAY ARGENTINA 2030
ACTA	446927
NOMBRE	ALBERTO MARTIN SCASSO VOLONTE
NOTIFICACION	<p>VISTO: La solicitud de Registro de la Marca URUGUAY ARGENTINA 2030, presentada bajo expediente No. 446927 a favor de ALBERTO MARTIN SCASSO VOLONTE de URUGUAY, para distinguir los productos y servicios comprendidos respectivamente en las Clases internacionales 1, 2, 5, 6, 7, 8, 10, 11, 12, 13, 15, 17, 19, 20, 21, 22, 23, 24, 26, 28, 31, 34, 36, 37 y 40.</p> <p>RESULTANDO: I) Se dedujo oposición por el Área de Signos Distintivos, por entender que la solicitud encuadra en la causal de nulidad relativa prevista en el artículo 5 numeral 8 de la Ley No. 17.011 de 25/9/998.</p> <p>II) División Legal, en su dictamen del 15 de noviembre de 2022, informa que de los antecedentes e instrucción cumplida en los</p>

	<p>acordonados, en particular el expediente No. 442720, marca URUGUAY ARGENTINA 2030, se concluye que el signo solicitado encuadra en la causal de nulidad precitada, por lo cual aconseja mantener la oposición y DESESTIMAR la presente gestión.</p> <p>III) La Encargada de Área Asuntos Jurídicos, en informe del 16 de noviembre de 2022, comparte lo dictaminado por su Asesor actuante.</p> <p>CONSIDERANDO: que esta Dirección, de conformidad con los dictámenes precedentes, resolverá en consecuencia.-</p> <p>ATENCIÓN: a lo expuesto, a lo que establecen la Ley de Marcas No 17.011 de 25 de setiembre de 1998, su Decreto Reglamentario No. 34/999 de 3 de febrero de 1999 y disposiciones modificativas.-</p> <p style="text-align: center;">LA DIRECCION NACIONAL DE LA PROPIEDAD INDUSTRIAL</p> <p style="text-align: center;">R E S U E L V E</p> <p>1°.- DESESTÍMASE la solicitud de Registro de Marca URUGUAY ARGENTINA 2030, presentada bajo expediente No. 446927 a nombre de ALBERTO MARTIN SCASSO VOLONTE de URUGUAY, para distinguir los productos y servicios comprendidos respectivamente en las Clases internacionales 1, 2, 5, 6, 7, 8, 10, 11, 12, 13, 15, 17, 19, 20, 21, 22, 23, 24, 26, 28, 31, 34, 36, 37 y 40.</p> <p>2°.- NOTIFÍQUESE, publíquese, efectúense las anotaciones de estilo y oportunamente archívese.</p>
--	---

NOTIFICACIONES DE RECURSO

De conformidad con lo establecido por el numeral 4° del artículo 80 de la Ley 17.011 del 25 de setiembre de 1998 y artículo 87 del decreto N° 34/999 del 3 de febrero de 1999, se notifica a quien se cita a continuación, por razones de su interés, debe presentarse en sección Recursos de la Dirección Nacional de Propiedad Industrial, sita en la calle Rincón 723, 03er. Piso.

MARCA	<i>IN</i>
ACTA	419900
NOMBRE	DOCRILAN S.A
NOTIFICACION	<p>VISTO: La acción de cancelación de la marca <i>IN</i>, promovida por <i>Linkedin Corporation</i>, de acuerdo al artículo 19 de la Ley 17011 de 25/9/998, en la redacción dada por el artículo 187 de la Ley 19.149, del 24/10/013.</p> <p>RESULTANDO: I) Que dicha marca es de tipo mixto, se concedió bajo Acta No. 419900 a Docrilan S.A. de Uruguay, para distinguir las Clases internacionales 41 y 43, por resolución del 19 de agosto de 2013 y está vigente hasta la misma fecha del 2023.</p> <p>II) Que la compareciente promovió la cancelación por falta de uso del registro citado, en base a lo expuesto a fojas 1 y ss, de la pieza correspondiente.</p> <p>III) Que la División Recursos y otras Acciones se expidió por dictamen del 6 de octubre de 2022, informando que la acción se promovió en tiempo y forma, tuvo por acreditada la titularidad de interés calificado por parte de la accionante, y por los motivos allí expuestos, y dado que la titular del registro no aportó prueba alguna sobre el uso del mismo, aconsejó hacer lugar a la cancelación promovida.</p> <p>IV) La Encargada de Área Asuntos Jurídicos, en informe del 11 de octubre de 2022, comparte lo dictaminado por su Asesor actuante.</p> <p>CONSIDERANDO: que esta Dirección, de conformidad con los informes de su Área Asuntos Jurídicos, resolverá en consecuencia.</p> <p>ATENTO: A lo precedentemente expuesto, a lo que establecen las disposiciones precitadas, la Ley No. 17011 de 25/9/998, Decretos Reglamentarios Nos. 34/999 de 3/2/999, 277/014 de 1/10/014, y normas concordantes.</p> <p style="text-align: center;">LA DIRECCION NACIONAL DE LA PROPIEDAD INDUSTRIAL</p> <p style="text-align: center;">R E S U E L V E</p> <p>1°.- CANCELÁSE el registro de la marca <i>IN</i>, concedida bajo <i>Acta No. 419900 a Docrilan S.A. de Uruguay</i>, para distinguir las Clases internacional <i>41 y 43</i>.</p> <p>2°.- NOTIFÍQUESE, intímese la entrega del título, efectúense las anotaciones de estilo y publíquese. Cumplido, archívese.</p> <p>acr</p>

MARCA	CORAL
ACTA	459255
NOMBRE	GERARDO CARDONA
NOTIFICACION	<p>VISTO: La acción de cancelación de la marca CORAL, promovida por CADOREL S.A., de acuerdo al artículo 19 de la Ley 17011 de 25/9/998, en la redacción dada por el artículo 187 de la Ley 19.149, del 24/10/013.</p> <p>RESULTANDO: I) Que dicha marca es de tipo denominativo, se concedió al Sr. Gerardo Cardona de Uruguay, bajo Acta 459255, para distinguir la Clase internacional 35, por resolución del 11/9/2015 y está vigente hasta la misma fecha del 2025</p> <p>II) Que la compareciente promovió la cancelación por falta de uso del registro citado, en base a lo expuesto a fojas 1 y ss, de la pieza correspondiente.</p> <p>III) Que la División Recursos y otras Acciones se expidió por dictamen del 27 de octubre de 2022, informando que la acción se promovió en tiempo y forma, tuvo por acreditada la titularidad de interés calificado por parte de la accionante, y por los motivos allí expuestos, y dado que no se aportó prueba de uso de la marca de acuerdo a los requisitos legales respectivos, aconsejó hacer lugar a la cancelación promovida.</p> <p>IV) La Encargada de Área Asuntos Jurídicos, en informe de la misma fecha, comparte lo dictaminado por su Asesor actuante.</p> <p>CONSIDERANDO: que esta Dirección, de conformidad con los informes de su Área Asuntos Jurídicos, resolverá en consecuencia.</p> <p>ATENTO: A lo precedentemente expuesto, a lo que establecen las disposiciones precitadas, la Ley No. 17011 de 25/9/998, Decretos Reglamentarios Nos. 34/999 de 3/2/999, 277/014 de 1/10/014, y normas concordantes.</p> <p style="text-align: center;">LA DIRECCION NACIONAL DE LA PROPIEDAD INDUSTRIAL</p> <p style="text-align: center;">R E S U E L V E</p> <p>1°.- CANCELÁSE el registro de la Marca CORAL, concedida bajo Acta No. 459255, a GERARDO CARDONA de Uruguay, para distinguir la Clase internacional 35.</p> <p>2°.- NOTIFÍQUESE, intímese la entrega del título, efectúense las anotaciones de estilo y publíquese. Cumplido, archívese.</p> <p>acr</p>

MARCA	+ BUS + BUS
ACTA	457464
NOMBRE	IMPULSO CREATIVO SRL
NOTIFICACION	<p>VISTO: Los recursos de revocación y jerárquico deducidos por la firma, IMPULSO CREATIVO SRL de URUGUAY, contra la resolución de fecha 10 de enero de 2020.</p> <p>RESULTANDO: I) Que la referida resolución concedió la solicitud de</p>

	<p>registro de la Marca "+ <i>BUS + BUS</i>" (<i>mixta</i>) a favor de la firma IMPULSO CREATIVO SRL de URUGUAY, para distinguir los servicios comprendidos en la clase internacional 38, bajo acta N° 457464</p> <p>II) Que la firma compareciente interpone en tiempo y forma los recursos administrativos correspondientes.</p> <p>III) Que la Asesoría Letrada de ésta Dirección entiende que los argumentos de la recurrente no consiguen conmovier los fundamentos de la Resolución impugnada.</p> <p>CONSIDERANDO: que esta Dirección comparte lo dictaminado por su Asesoría Letrada y resolverá en consecuencia.</p> <p>ATENTO: a lo expuesto, y a lo que establecen la Ley 17.011 de 25 de setiembre de 1998 y su Decreto Reglamentario 34/99 de 3 de febrero de 1999.</p> <p style="text-align: center;">LA DIRECCIÓN NACIONAL DE LA PROPIEDAD INDUSTRIAL</p> <p style="text-align: center;">R E S U E L V E</p> <p>1°) MANTIÉNESE la Resolución de 10 de enero de 2020 que concedió la solicitud de registro de la Marca "+ <i>BUS + BUS (mixta)</i>" a favor de la firma IMPULSO CREATIVO SRL de URUGUAY, para distinguir los servicios comprendidos en la clase internacional 38, bajo acta N° 457464</p> <p>2°) ELÉVASE al Poder Ejecutivo por intermedio del Ministerio de Industria, Energía y Minería, a efectos de resolver el recurso jerárquico interpuesto en subsidio.</p>
--	---

MARCA	URUGUAY ARGENTINA 2030
ACTA	440882
NOMBRE	SCASSO VOLONTE, ALBERTO MARTIN
NOTIFICACION	<p>VISTO: Los recursos de revocación y jerárquico en subsidio interpuestos por "DANIEL GERARD WILD MATALON" de URUGUAY, contra la resolución de esta Dirección de fecha 16 de agosto de 2021.-</p> <p>RESULTANDO: I) Que la referida resolución concede el registro de la marca URUGUAY ARGENTINA 2030, con la salvedad prevista por el artículo 74 de la Ley 17011 de 25/9/998 respecto de los términos URUGUAY y ARGENTINA, solicitado bajo expediente No. 440882 a favor de SCASSO VOLONTE, ALBERTO MARTIN de URUGUAY, para distinguir los productos y servicios comprendidos respectivamente en las Clases internacionales 3, 30, 32, 35, 41 y 45.-</p> <p>II) Que el compareciente interpone en tiempo y forma los recursos administrativos correspondientes, solicitando la revocación del acto.-</p> <p>III) Que la Asesoría Letrada de esta Dirección, se expide considerando que: los signos impresionan distintos, que es posible la coexistencia de los mismos, que existen otras marcas con la expresión "2030", etc.; por lo que aconseja mantener la resolución mencionada y franquear el recurso jerárquico interpuesto en subsidio.-</p> <p>CONSIDERANDO: Que esta Dirección, comparte lo dictaminado</p>

	<p>por su Asesoría Letrada y procederá en consecuencia.- ATENCIÓN: A lo precedentemente expuesto, a lo que establecen la Ley de Marcas No 17.011 de 25 de setiembre de 1998, su Decreto Reglamentario No. 34/999 de 3 de febrero de 1999 y normas concordantes.-</p> <p style="text-align: center;">LA DIRECCION NACIONAL DE LA PROPIEDAD INDUSTRIAL</p> <p style="text-align: center;">R E S U E L V E</p> <p>1°.- MANTIÉNESE la Resolución de esta Dirección de fecha 16 de agosto de 2021, por la cual se concede el registro de la marca URUGUAY ARGENTINA 2030, con la salvedad prevista por el artículo 74 de la Ley 17011 de 25/9/998 respecto de los términos URUGUAY y ARGENTINA, solicitado bajo expediente No. 440882 a favor de SCASSO VOLONTE, ALBERTO MARTIN de URUGUAY, para distinguir los productos y servicios comprendidos respectivamente en las Clases internacionales 3, 30, 32, 35, 41 y 45, y en consecuencia, elevar el recurso jerárquico interpuesto en subsidio.-</p> <p>2°.- ELÉVASE al Poder Ejecutivo, por intermedio del Ministerio de Industria, Energía y Minería, a efectos de resolver el recurso jerárquico interpuesto en subsidio.-</p>
--	--

MARCA	URUGUAY ARGENTINA 2030
ACTA	440882
NOMBRE	SCASSO VOLONTE, ALBERTO MARTIN
NOTIFICACION	<p>VISTO: los recursos de revocación y jerárquico en subsidio interpuestos por DANIEL GERARD WILD MATALON, contra la Resolución de la Dirección Nacional de la Propiedad Industrial (DNPI), de 16 de agosto de 2021;</p> <p>RESULTANDO: I) que por la referida Resolución se concedió el registro de la marca "URUGUAY ARGENTINA 2030", con la salvedad prevista por el artículo 74 de la Ley 17011 de 25 de setiembre de 1998 respecto de los términos URUGUAY y ARGENTINA, solicitado bajo Acta N° 440882 a favor de SCASSO VOLONTE, ALBERTO MARTIN de URUGUAY, para distinguir los productos y servicios comprendidos en las clases internacionales 3, 30, 32, 35, 41 y 45;</p> <p>II) que desde el punto de vista formal, los recursos de revocación y jerárquico fueron presentados en tiempo y forma;</p> <p>III) que con posterioridad, la Dirección Nacional de la Propiedad Industrial franqueó el recurso jerárquico, por lo que procede su consideración;</p> <p>IV) que en el aspecto sustancial, el recurrente al fundamentar los medios impugnativos interpuestos manifiesta que es titular de la marca mixta "2030", Acta N° 440882, la cual protege los productos de las clases internacionales 3, 16, 28, 29, 30, 31, 32, 33 y servicios</p>

de la clase internacional 38, 41 y 43;

V) que alega que el Sr. Alberto Martín Scasso se ha basado en las marcas opositoras al momento de solicitar el registro de la marca de autos, y que la resolución impugnada le causa agravio porque permite la concesión de un signo confundible con su marca;

VI) que además argumenta que existe confusión gráfica y fonética entre los signos en pugna. Interpreta que las marcas enfrentadas impresionan de la misma manera, como marcas de un mismo titular;

CONSIDERANDO: I) que la Asesoría Jurídica del Ministerio de Industria, Energía y Minería entiende conforme a Derecho el acto impugnado, y comparte lo informado por la Dirección Nacional de la Propiedad Industrial;

II) que analizadas las presentes actuaciones, consideramos que los conjuntos marcarlos en pugna, observan las claras diferencias que exige el artículo 6° de la Ley N° 17011 de 25 de setiembre de 1998 y su Decreto Reglamentario de 3 de febrero de 1999;

III) que en virtud de lo expuesto, la Asesoría Jurídica sugiere desestimar el recurso jerárquico interpuesto en subsidio;

ATENTO: a lo expuesto, a lo dispuesto por la Ley N° 17.011, de 25 de setiembre de 1998, el Decreto N° 34/999, de 3 de febrero de 1999, a lo dictaminado por la Asesoría Jurídica y a lo preceptuado por la Resolución del Poder Ejecutivo N° 13/993, de 12 de enero de 1993, Texto Ordenado de Delegación de Atribuciones, Título I, numeral 1°, literal a);

**EL MINISTRO DE INDUSTRIA, ENERGÍA Y MINERÍA,
EN EJERCICIO DE ATRIBUCIONES DELEGADAS,**

RESUELVE:

10.- Desestímase el recurso jerárquico interpuesto en subsidio por DANIEL GERARD WILD MATALON, contra la Resolución de la Dirección Nacional de la Propiedad Industrial (DNPI), de 16 de agosto de 2021, por la que se concedió el registro de la marca "URUGUAY ARGENTINA 2030", con la salvedad prevista por el artículo 74 de la Ley 17011 de 25 de setiembre de 1998 respecto de los términos URUGUAY y ARGENTINA, solicitado bajo Acta N° 440882 a favor de SCASSO VOLONTE, ALBERTO MARTIN de URUGUAY, para distinguir los productos y servicios comprendidos en las clases internacionales 3, 30, 32, 35, 41 y 45.

2°.- Comuníquese y pase a la Dirección Nacional de la Propiedad Industrial.

SOLICITUDES DE PATENTES DE INVENCION

(19) Dirección Nacional de la Propiedad Industrial – URUGUAY

(12) Invención

(11) UY a/039219

- (51) Clasificación Internacional:** A 01N 57/02(2006.01), A 01N 57/10(2006.01), A 01N 57/16(2006.01), A 01P 13/00(2006.01) // A 01P 13/00 (A 01N 57:16)
- (22) Fecha de presentación:** 14/05/2021
- (30) Datos de prioridad:**
- (71) Solicitante:** THE BOARD OF TRUSTEES OF THE UNIVERSITY OF ARKANSAS [US]
- (72) Inventor:** Grant Lawson PRIESS [US]; Jason Keith NORSWORTHY [US]
- (74) Agente/apoderado:** GONZALO FERNÁNDEZ SECCO (34)
- (54) Título:** ADITIVO DE GLUFOSINATO PARA MEJORAR EL CONTROL DE MALEZAS
- (57) Resumen:** En la presente se divulgan un herbicida y métodos para el control de un pasto o una maleza de hoja ancha en un cultivo. El herbicida comprende una cantidad eficaz de glufosinato, o una sal del mismo, y una cantidad eficaz de un inhibidor metabólico.

(19) Dirección Nacional de la Propiedad Industrial – URUGUAY

(12) Invención

(11) UY a/039235

- (51) **Clasificación Internacional:** C 08J 11/00(2006.01), C 08L 1/12(2006.01), A 24D 3/00(20200101), A 24D 3/10(2006.01), B 29B 17/00(2006.01)
- (22) **Fecha de presentación:** 28/05/2021
- (30) **Datos de prioridad:**
- (71) **Solicitante:** MONTOSSI RODRIGUEZ, NICOLAS ALBERTO [UY]
- (72) **Inventor:** NICOLÁS ALBERTO, MONTOSSI RODRÍGUEZ [UY]
- (74) **Agente/apoderado:** Nicolas Montossi ()
- (54) **Título:** PROCESO PARA RECICLAR COLILLAS DE CIGARRILLO

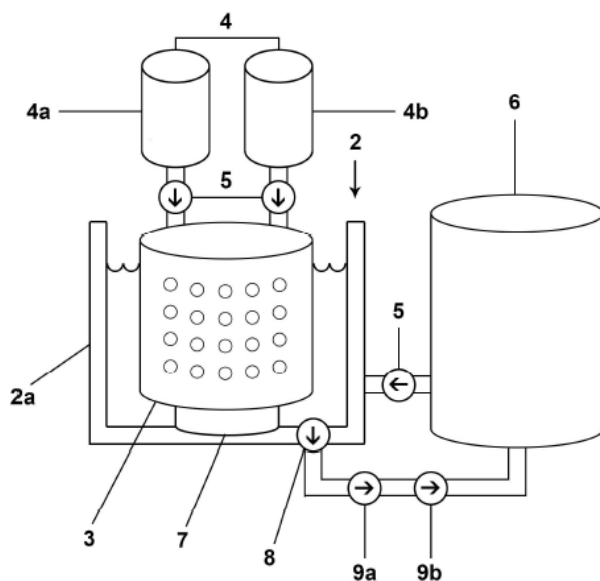

- (57) **Resumen:** Refiere a un proceso para reciclar colillas de cigarrillo y un método para fabricar esmaltes a partir del resultado de dicho reciclaje. Este proceso y método implican: lavar las colillas para recuperar el filtro (eliminando las sustancias tóxicas, blanqueando el material y eliminando el mal olor); separar los compuestos orgánicos como el tabaco y el papel; secar, reciclar el filtro mediante el uso de solventes mejorando las propiedades mecánicas mediante el uso de aditivos. Resulta en la obtención de un esmalte que proporciona una capa sólida no pegajosa ni quebradiza, de secado rápido y con un acabado brillante y resistente.

(19) Dirección Nacional de la Propiedad Industrial – URUGUAY**(12) Invención****(11) UY a/039236**

- (51) Clasificación Internacional:** C 08J 11/00(2006.01), C 08L 1/12(2006.01), B 09B 3/00(2006.01), A 24D 3/10(2006.01), B 27N 3/08(2006.01), B 27N 3/00(2006.01), B 27N 3/04(2006.01)
- (22) Fecha de presentación:** 28/05/2021
- (30) Datos de prioridad:**
- (71) Solicitante:** MONTOSSI RODRIGUEZ, NICOLAS ALBERTO [UY]
- (72) Inventor:** NICOLÁS ALBERTO, MONTOSSI RODRÍGUEZ [UY]
- (74) Agente/apoderado:** Nicolas Montossi ()
- (54) Título:** PROCESO ORGÁNICO PARA RECICLAR COLILLAS DE CIGARRILLO
- (57) Resumen:** La presente invención revela un proceso orgánico para reciclar colillas de cigarrillo mediante el uso de un hongo y un material compuesto bio-basado, en donde dicho hongo se inocula en un sustrato de colillas, lo que genera una red de células de micelio interconectadas que descomponen a las colillas para luego mezclarlas con otro sustrato orgánico. Este material compuesto bio-basado puede ser utilizado para fabricar embalajes o placas con características similares a la madera.

(19) Dirección Nacional de la Propiedad Industrial – URUGUAY**(12) Invención****(11) UY a/039692**

- (51) **Clasificación Internacional:** B 01D 59/00(2006.01), G 21G 4/00(2006.01), G 21G 1/00(2006.01)
- (22) **Fecha de presentación:** 25/03/2022
- (30) **Datos de prioridad:** 202121017481 15/04/2021 IN
- (71) **Solicitante:** Su-N Energy Holdings Ltd [CA]
- (72) **Inventor:** SUNEEL NAVNITDAS PAREKH [IN]; PLATINA SUNEEL PAREKH [IN]; NAVNITDAS RADHAKISHAN PAREKH [IN]
- (74) **Agente/apoderado:** GONZALO FERNÁNDEZ SECCO (34)
- (54) **Título:** PROCESO, APARATO Y SISTEMA PARA LA PRODUCCIÓN, SEPARACIÓN Y PURIFICACIÓN DE RADIOISÓTOPOS

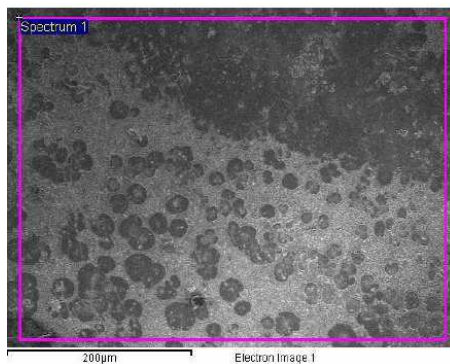
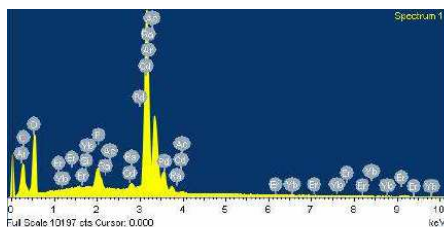

- (57) **Resumen:** Proceso, Aparato y Sistema para la Producción, Separación y Purificación de Radioisótopos para aplicaciones médicas, industriales, agrícolas y energéticas.

(19) Dirección Nacional de la Propiedad Industrial – URUGUAY**(12) Invención****(11) UY a/039717**

- (51) **Clasificación Internacional:** D 21F 5/20(2006.01), F 26B 21/02(2006.01), F 26B 3/02(2006.01), F 26B 20/00(2006.01)
- (22) **Fecha de presentación:** 04/04/2022
- (30) **Datos de prioridad:** US 17/223,242 06/04/2021 US
- (71) **Solicitante:** CMPC TISSUE S.A. [CL] y Andritz Ltd. [CA]
- (72) **Inventor:** George Z. NOWAKOWSKI [CA]; Reinaldo URIBE ARANCIBIA [CL]
- (74) **Agente/apoderado:** STELLA MARINA WENG POLICICCHIO (218)
- (54) **Título:** SISTEMA PARA EL RECALENTAMIENTO DE AIRE EN SECADORES

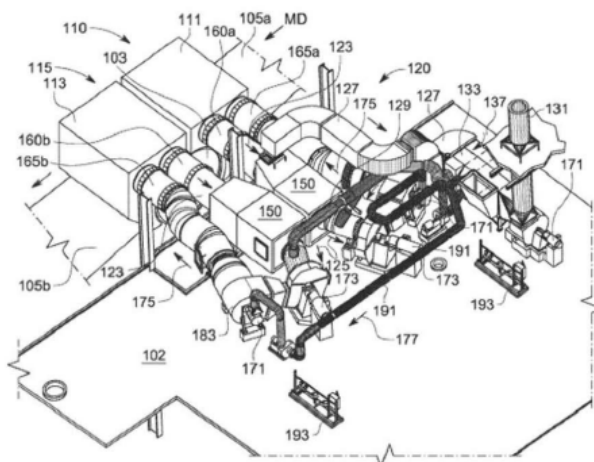

- (57) **Resumen:** Sistema de recirculación del aire de procesos que reduce la emisión de gases de efecto invernadero, que comprende un secador; y una cámara de mezcla de calefactor eléctrico, que comprende: un extremo aguas arriba configurado para comunicarse con un conducto de salida de aire que está comunicado con el secador; un extremo aguas abajo configurado para comunicarse con un conducto de ingreso de aire recalentado que está comunicado con el secador; una primera cámara y una segunda cámara adyacente a dicha primera cámara; un primer y segundo dámper de entrada; y un calentador de aire eléctrico en la primera cámara.

(19) Dirección Nacional de la Propiedad Industrial – URUGUAY**(12) Invención****(11) UY a/039718**

- (51) **Clasificación Internacional:** A 01N 43/40(2006.01), A 01N 43/54(2006.01), A 01N 43/80(2006.01), A 01P 13/00(2006.01), C 07D 413/14(2006.01)// A 01P 13/00
- (22) **Fecha de presentación:** 06/04/2022
- (30) **Datos de prioridad:** 21167290.2 07/04/2021 GB y 21188781.5 30/07/2021 GB
- (71) **Solicitante:** SYNGENTA CROP PROTECTION AG [CH]
- (72) **Inventor:** WILLIAMS, John [GB]; WHITTINGHAM, William Guy [GB]; WAILES, Jeffrey Steven [GB]
- (74) **Agente/apoderado:** JUAN LAPENNE DE SALTERAIN (211)
- (54) **Título:** Derivados de isoxazolina activos como herbicidas y procesos e intermedios usados para la preparación

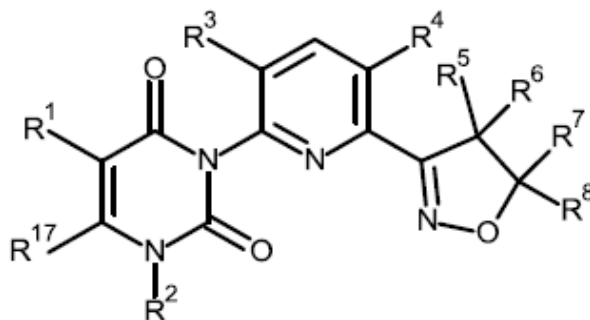

- (57) **Resumen:** Compuestos de fórmula (I) (I) en donde los sustituyentes son como se definen en la reivindicación 1, útiles como pesticidas, especialmente como herbicidas.

(19) Dirección Nacional de la Propiedad Industrial – URUGUAY**(12) Invención****(11) UY a/039722**

- (51) **Clasificación Internacional:** C 07D 257/02(2006.01), C 07D 413/14(2006.01), C 07D 413/12(2006.01), C 07D 413/10(2006.01), C 07D 407/10(2006.01), C 07D 401/14(2006.01), C 07D 401/12(2006.01), C 07D 271/06(2006.01), C 07D 491/056(2006.01), A 61K 31/4427(2006.01), A 61K 31/436(2006.01), A 61K 31/4245(2006.01), A 61K 31/4155(2006.01), A 61K 31/41(2006.01), A 61K 31/357(2006.01), A 61P 37/00(2006.01), A 61P 11/00(2006.01)// A 61P 11/00, 37/00
- (22) **Fecha de presentación:** 08/04/2022
- (30) **Datos de prioridad:** PCT/CN2021/087655 16/04/2021 CN
- (71) **Solicitante:** NOVARTIS AG [CH]
- (72) **Inventor:** Carsten SPANKA [DE]; Till ROEHN [DE]; Andreas KORDIKOWSKI [DE]; Rainer Martin LÜÖND [CH]; Gebhard THOMA [DE]; Christian MARKERT [DE]; Wolfgang MILTZ [DE]; Yugang LIU [US]; Tian XIE [CN]
- (74) **Agente/apoderado:** JUAN LAPENNE DE SALTERAIN (211)
- (54) **Título:** Nuevos derivados de heteroaril aminopropanol

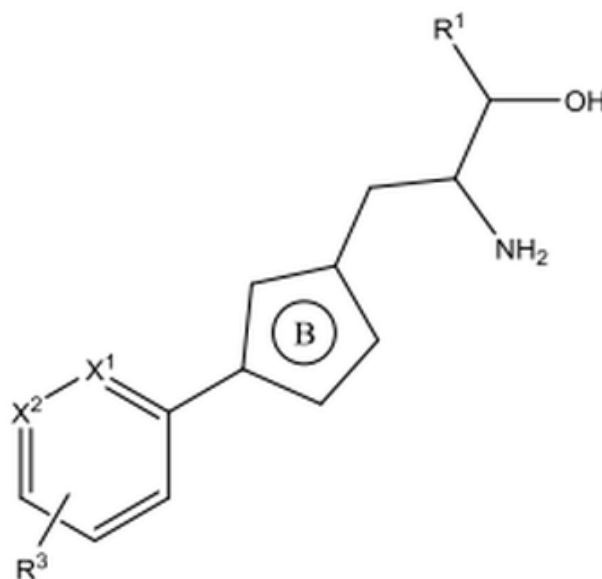

- (57) **Resumen:** La presente invención proporciona un compuesto de fórmula (I), o una sal farmacéuticamente aceptable de este; (I) un método para elaborar los compuestos de la invención, y sus usos terapéuticos. La presente invención además proporciona una combinación de agentes farmacológicamente activos y una composición farmacéutica.

(19) Dirección Nacional de la Propiedad Industrial – URUGUAY

(12) Invención

(11) UY a/039725

- (51) **Clasificación Internacional:** A 01N 43/40(2006.01), A 01P 3/00(2006.01), C 07D 213/89(2006.01), C 07D 401/04(2006.01), C 07D 409/04(2006.01), C 07D 213/64(2006.01), C 07D 213/85(2006.01)// A 01P 3/00
- (22) **Fecha de presentación:** 08/04/2022
- (30) **Datos de prioridad:** US 63/174,332 13/04/2021 US
- (71) **Solicitante:** FMC CORPORATION [US]
- (72) **Inventor:** AKWABOAH, Daniel [US]; LONG, Jeffrey Keith [US]
- (74) **Agente/apoderado:** STELLA MARINA WENG POLICICCHIO (218)
- (54) **Título:** PIRIDONAS FUNGICIDAS

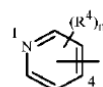
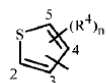
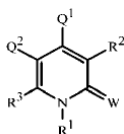

- (57) **Resumen:** Se divulgan compuestos de Fórmula 1, incluidos todos los isómeros geométricos y estereoisómeros, N-óxidos y sales de estos, donde W, R1, R2, R3, Q1 y Q2 son como se definen en la divulgación. También se divulgan composiciones que contienen los compuestos de Fórmula 1 y métodos para controlar una enfermedad de las plantas provocada por un patógeno fúngico que comprende aplicar una cantidad eficaz de un compuesto o una composición de la invención.

(19) Dirección Nacional de la Propiedad Industrial – URUGUAY**(12) Invención****(11) UY a/039726**

- (51) **Clasificación Internacional:** A 01N 37/52(2006.01), A 01N 43/40(2006.01), C 07D 213/74(2006.01)
- (22) **Fecha de presentación:** 19/04/2022
- (30) **Datos de prioridad:** 21168605.0 15/04/2021 EP
- (71) **Solicitante:** SYNGENTA CROP PROTECTION AG [CH]
- (72) **Inventor:** ZELLER, Martin [CH]; MEYER, Daniel [CH]; MOUSSA, Amgad Salah [DE]; TERINEK, Miroslav [CE]; KRIEGER, Jean-Philippe [FR]
- (74) **Agente/apoderado:** JUAN LAPENNE DE SALTERAIN (211)
- (54) **Título:** PROCESO PARA LA PREPARACIÓN DE N-ARILFORMAMIDINAS PARA PROTEGER PLANTAS FRENTE A ENFERMEDADES QUE SO

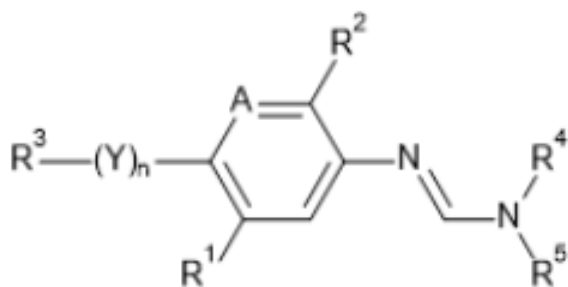

- (57) **Resumen:** La presente invención se refiere a un proceso para la preparación de derivados de N-arilformamidina adecuados para su uso, por ejemplo, como principios activos, que tienen actividad microbicida, en particular, actividad fungicida.

(19) Dirección Nacional de la Propiedad Industrial – URUGUAY

(12) Invención

(11) UY a/039727

- (51) **Clasificación Internacional:** C 07D 405/12(2006.01), C 07D 401/14(2006.01), C 07D 401/12(2006.01), C 07D 401/10(2006.01), C 07D 413/10(2006.01), C 07D 231/56(2006.01), C 07D 217/22(2006.01), C 07D 487/04(2006.01), C 07D 417/12(2006.01), C 07D 307/80(2006.01), A 61K 31/519(2006.01), A 61K 31/4439(2006.01), A 61K 31/443(2006.01), A 61K 31/427(2006.01), A 61K 31/423(2006.01), A 61K 31/4184(2006.01), A 61K 31/343(2006.01), A 61K 31/416(2006.01), A 61P 35/00(2006.01), A 61P 37/00(2006.01)// A 61P 35/00, 37/00
- (22) **Fecha de presentación:** 19/04/2022
- (30) **Datos de prioridad:** US 63/174,860 14/04/2021 US
- (71) **Solicitante:** BIOCRYST PHARMACEUTICALS, INC. [US]
- (72) **Inventor:** BABU, Yarlagadda S. [US]; KOTIAN, Pravin L. [US]; RAMAN, Krishnan [US]; LU, Peng-Cheng [CN]; ZHANG, Weihe [CN]
- (74) **Agente/apoderado:** AGUSTÍ N MAYER WEST (205)
- (54) **Título:** INHIBIDORES HETEROAROMÁTICOS BICÍCLICOS DE LA PEPTIDASA 5 RELACIONADA CON LA CALICREÍNA (KLK5)

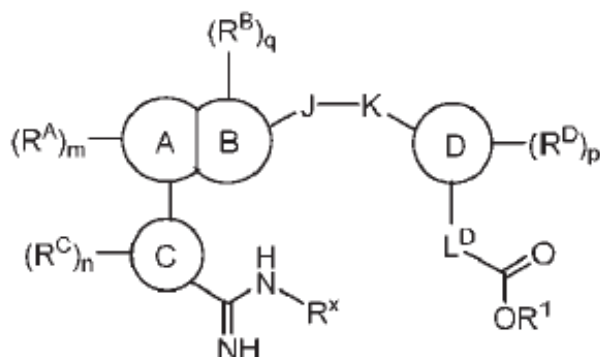

- (57) **Resumen:** Compuestos de las fórmulas (I)-(IV), y sales farmacéuticamente aceptables de los mismos, que son inhibidores de la peptidasa 5 relacionada con la calicreína (KLK5). También se proveen composiciones farmacéuticas que comprenden un compuesto tal, y métodos para usar los compuestos y las composiciones en el tratamiento o la prevención de una enfermedad o condición caracterizada por una actividad aberrante de la KLK5, tal como el síndrome de Netherton.

(19) Dirección Nacional de la Propiedad Industrial – URUGUAY**(12) Invención****(11) UY a/039728**

- (51) **Clasificación Internacional:** A 01N 25/02(2006.01), A 01N 43/40(2006.01), A 01P 21/00(2006.01)// A 01P 21/00
- (22) **Fecha de presentación:** 19/04/2022
- (30) **Datos de prioridad:** 63/176,966 20/04/2021 US
- (71) **Solicitante:** Verdesian Life Sciences U.S., LLC [US]
- (72) **Inventor:** Amy Burton [US]; Kuide Qin, [US]; Elizabeth Anne Marie Waller [US]
- (74) **Agente/apoderado:** JUAN LAPENNE DE SALTERAIN (211)
- (54) **Título:** USO DE NITRAPIRINA PARA UN MEJOR CRECIMIENTO Y DESARROLLO VEGETAL

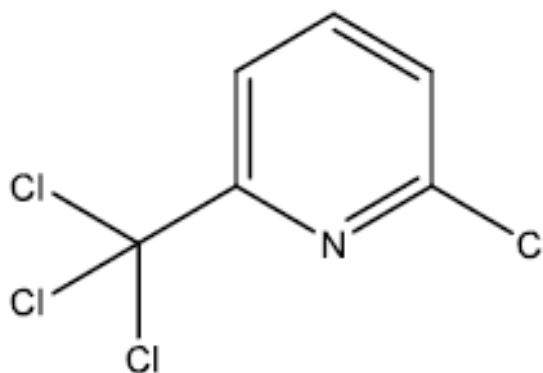

- (57) **Resumen:** La presente invención se refiere a composiciones bioestimulantes que contienen nitrapirina y que encuentran utilidad particular en usos agrícolas, por ejemplo, se aplican directamente al suelo y/o a partes de plantas, por sí solas o en combinación con fertilizantes para promover el crecimiento vegetal. Más particularmente, la materia se refiere a métodos para aplicar nitrapirina en un índice eficaz que es mucho menor que los índices que se usan típicamente para suscitar la inhibición de la nitrificación cuando se aplican a áreas diana que contienen plantas de cultivos cultivados.

(19) Dirección Nacional de la Propiedad Industrial – URUGUAY**(12) Invención****(11) UY a/039731**

- (51) **Clasificación Internacional:** A 01N 43/42(2006.01), A 01N 43/54(2006.01), A 01P 3/00(2006.01), C 07D 215/16(2006.01), C 07D 217/22(2006.01)// A 01P 3/00
- (22) **Fecha de presentación:** 19/04/2022
- (30) **Datos de prioridad:** 21181270.6 23/06/2021 EP y 202111018248 20/04/2021 IN
- (71) **Solicitante:** SYNGENTA CROP PROTECTION AG [CH]
- (72) **Inventor:** WEISS, Matthias [CH]; MAHAJAN, Atul [IN]; PASCANU, Vlad [RO]; SEN, Indira [IN]
- (74) **Agente/apoderado:** JUAN LAPENNE DE SALTERAIN (211)
- (54) **Título:** DERIVADOS MICROBIOCIDAS DE 3-(3,4-DIHIDROISOQUINOLIN-1-IL)QUINOLIN/QUINOXALINA SUSTITUIDOS COMO AGEN

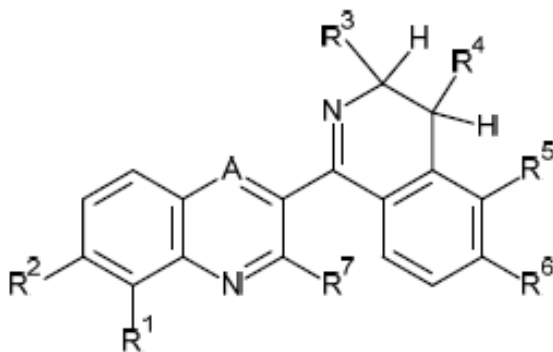

- (57) **Resumen:** Compuestos de fórmula (I): (I) en donde los sustituyentes son como se definen en la reivindicación 1, útiles como plaguicidas, especialmente como fungicidas.

(19) Dirección Nacional de la Propiedad Industrial – URUGUAY**(12) Invención****(11) UY a/039732**

- (51) **Clasificación Internacional:** A 01N 25/14(2006.01), A 01N 57/28(2006.01), A 01N 53/00(2006.01), A 01N 25/30(2006.01)
- (22) **Fecha de presentación:** 19/04/2022
- (30) **Datos de prioridad:** 202111018285 20/04/2021 IN
- (71) **Solicitante:** Adama Makhteshim Ltd. [IL]
- (72) **Inventor:** Arunagirinathan Manickam Adhimoolam [IN]; Venkateswararao Yadagani [IN]
- (74) **Agente/apoderado:** JUAN LAPENNE DE SALTERAIN (211)
- (54) **Título:** COMPOSICIONES NOVEDOSAS QUE COMPRENDEN TENSIOACTIVO ANIÓNICO QUE CONTIENEN GRUPO SULFATO O SULFONATO

(57)

Resumen:

Composiciones pesticidas agrícolas sólidas de olor reducido, alta eficacia y alta dispersibilidad, que contienen al menos un insecticida sustancialmente insoluble en agua, un tensioactivo aniónico que contiene un grupo funcional sulfato o sulfonato, una sal de amonio y un vehículo; una composición agroquímica sólida que comprende acefato, sal de amonio y un vehículo; un método para reducir el olor de composiciones que contienen acefato, caracterizado por agregar sal de amonio a composiciones sólidas que contienen acefato y un vehículo; y el uso de sales de amonio para reducir el olor de composiciones sólidas que contienen acefato y un vehículo.

(19) Dirección Nacional de la Propiedad Industrial – URUGUAY**(12) Invención****(11) UY a/039737**

- (51) Clasificación Internacional:** A 61K 35/74(2015.01), A 61K 36/06(2006.01), A 61P 15/14(2006.01)// A 61P 15/14
- (22) Fecha de presentación:** 27/04/2022
- (30) Datos de prioridad:** 63/178,230 22/04/2021 US
- (71) Solicitante:** Native Microbials, Inc [US]
- (72) Inventor:** Mallory Embree [US]
- (74) Agente/apoderado:** FABIANA PENADES (216)
- (54) Título:** COMPOSICIONES Y MÉTODOS PARA MEJORAR EL RENDIMIENTO LÁCTEO Y LAS CARACTERÍSTICAS COMPOSICIONALES DE

- (57) Resumen:** La divulgación se refiere a microorganismos aislados, conjuntos microbianos y composiciones que los comprenden. Además, la divulgación proporciona métodos para utilizar los microorganismos, conjuntos microbianos y composiciones que los comprenden descriptos, en métodos para modular la producción y el rendimiento lácteo y los componentes lácteos en rumiantes. En aspectos particulares, la divulgación proporciona métodos para aumentar los componentes lácteos deseables en rumiantes.

(19) Dirección Nacional de la Propiedad Industrial – URUGUAY**(12) Invención****(11) UY a/039742**

- (51) Clasificación Internacional:** A 61K 38/38(2006.01), A 61P 25/28(2006.01)// A 61P 25/28
- (22) Fecha de presentación:** 28/04/2022
- (30) Datos de prioridad:** 21382388.3 30/04/2021 EM
- (71) Solicitante:** GRIFOLS WORLDWIDE OPERATIONS LIMITED [IE]
- (72) Inventor:** GRIFOLS ROURA VICTOR [ES]; NUÑEZ DOMENECH LAURA [ES]; PAEZ REGADERA ANTONIO MANUEL [ES]
- (74) Agente/apoderado:** Juan Eduardo Vanrell Falcon (144)
- (54) Título:** USO DE RECAMBIO PLASMATICO TERAPEUTICO Y RECAMBIO PLASMATICO DE BAJO VOLUMEN PARA EL TRATAMIENTO *
- (57) Resumen:** La presente invención se refiere a una composición que comprende albúmina humana a una concentración entre 5 % (p/v) y 25 % (p/v) para el tratamiento del deterioro cognitivo mediante recambio plasmático terapéutico (TPE, por sus siglas en inglés) y recambio plasmático de bajo volumen (LVPE, por sus siglas en inglés) en un paciente que lo necesite, en el que dicho paciente tiene una Mini prueba del estado mental (MMSE, por sus siglas en inglés) mayor o igual a 15.

(19) Dirección Nacional de la Propiedad Industrial – URUGUAY**(12) Invención****(11) UY a/039743**

- (51) **Clasificación Internacional:** C 07K 16/28(2006.01), C 07K 16/30(2006.01), C 07K 19/00(2006.01), A 61K 47/68(2017.01), A 61K 39/395(2006.01)// A 61K 47/68
- (22) **Fecha de presentación:** 28/04/2022
- (30) **Datos de prioridad:** 63/181,963 29/04/2021 US
- (71) **Solicitante:** AbbVie Inc. [US]
- (72) **Inventor:** Mark Anderson [US]; Cheng Ji [US]; Erwin R. Boghaert [US]; Andrew C. Phillips [GB]; Regina M. Reilly [US]; George A. Doherty [US]; Milan Bruncko [US]
- (74) **Agente/apoderado:** STELLA MARINA WENG POLICICCHIO (218)
- (54) **Título:** CONJUGADOS DE ANTICUERPO ANTI-C-MET Y FÁRMACO

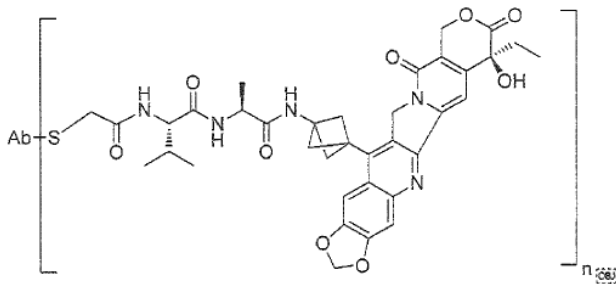

- (57) **Resumen:** La presente descripción proporciona conjugados de anticuerpo anti-c-Met y fármaco (ADC), que incluyen composiciones y métodos para usar tales ADC.

(19) Dirección Nacional de la Propiedad Industrial – URUGUAY**(12) Invención****(11) UY a/039745**

- (51) Clasificación Internacional:** C 12M 1/42(2006.01)
- (22) Fecha de presentación:** 29/04/2022
- (30) Datos de prioridad:** 63/181,583 29/04/2021 US
- (71) Solicitante:** MaxCyte, Inc. [US]
- (72) Inventor:** Diwash Acharya [NP]; James Brady [US]
- (74) Agente/apoderado:** FABIANA PENADES (216)
- (54) Título:** MÉTODOS DE ELECTROPORACIÓN SECUENCIAL

- (57) Resumen:** Aspectos de la divulgación se dirigen a una técnica de electroporación secuencial que proporciona varios pulsos eléctricos separados en el tiempo a las células, partículas celulares, vesículas lipídicas, liposomas, o para aumentar la eficacia de ingreso de uno o más agentes de interés a las células, partículas celulares, vesículas lipídicas, liposomas, tejidos, o derivados de estos, y para minimizar el daño por arco eléctrico o choque térmico; aumentar la eficacia de carga de un agente de interés; y mantener la viabilidad de las células, partículas celulares, vesículas lipídicas o tejidos y la capacidad de las células, partículas celulares, vesículas lipídicas.

(19) Dirección Nacional de la Propiedad Industrial – URUGUAY**(12) Invención****(11) UY a/039752**

- (51) Clasificación Internacional:** A 01H 1/00, A 01H 5/00, A 01N 63/02, C 12N 15/11, C 12N 15/32, C 12N 15/82, C 12N 5/10, C 12Q 1/68
- (22) Fecha de presentación:** 03/05/2022
- (30) Datos de prioridad:** 63/183,672 04/05/2021 US
- (71) Solicitante:** SYNGENTA CROP PROTECTION AG [CH]
- (72) Inventor:** ZHOU, Ailing [US]; ZHANG, Yan [CN]; CONVILLE, Jared [US]; AZHAKANANDAM, Kasimalai [US]
- (74) Agente/apoderado:** JUAN LAPENNE DE SALTERAIN (211)
- (54) Título:** MOLÉCULAS DE ÁCIDO NUCLEICO PARA CONFERIR PROPIEDADES INSECTICIDAS A PLANTAS

- (57) Resumen:** La presente divulgación se refiere a una secuencia de ácido nucleico que confiere expresión de proteínas insecticidas cuando se introduce en una célula, así como composiciones relacionadas y métodos de uso de las mismas. En algunos aspectos, la divulgación proporciona una planta que comprende la secuencia de ácido nucleico.

(19) Dirección Nacional de la Propiedad Industrial – URUGUAY**(12) Invención****(11) UY a/039754**

- (51) **Clasificación Internacional:** A 61K 31/40(2006.01), A 61P 25/24(2006.01)// A 61P 25/24
- (22) **Fecha de presentación:** 04/05/2022
- (30) **Datos de prioridad:** 17/307,858 04/05/2021 US; 17/670,123 11/02/2022 US y 63/313,792 25/02/2022 US
- (71) **Solicitante:** Janssen Pharmaceuticals, Inc. [US]
- (72) **Inventor:** Mark Schmidt [US]; Vanina Popova [BE]; Adam Savitz [US]; Rama Melkote [US]; Iva Kezic [CZ]; Srihari Gopal [US]; Darrell Pemberton [UK]; Chakradhar Lagishetty [IN]; Wayne C. Drevets [US]
- (74) **Agente/apoderado:** DIEGO DUFRECHU RODRIGUEZ (192)
- (54) **Título:** COMPOSICIONES Y MÉTODOS PARA EL TRATAMIENTO DE LA DEPRESIÓN

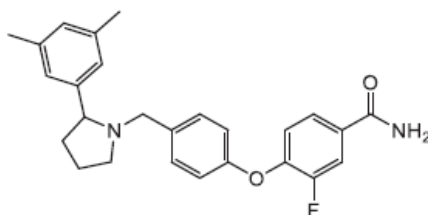

- (57) **Resumen:** La descripción proporciona métodos para tratar el trastorno depresivo mayor en un paciente humano que tiene anhedonia moderada o grave. Los métodos comprenden administrar al paciente que lo necesite una cantidad efectiva de aticaprant, o una sal farmacéuticamente aceptable de este. En algunas modalidades, el paciente tuvo una respuesta inadecuada a otra terapia antidepresiva antes del tratamiento con aticaprant. En otras modalidades, la otra terapia antidepresiva comprendía un inhibidor selectivo de la recaptación de serotonina (SSRI), inhibidor de la recaptación de serotonina-norepinefrina (SNRI), o una combinación de estos.

(19) Dirección Nacional de la Propiedad Industrial – URUGUAY**(12) Invención****(11) UY a/039755**

- (51) **Clasificación Internacional:** A 01N 43/10(2006.01), A 01N 43/40(2006.01), A 01N 43/836(2006.01), C 07D 413/14(2006.01), C 07D 487/04(2006.01), C 07D 495/04(2006.01)
- (22) **Fecha de presentación:** 04/05/2022
- (30) **Datos de prioridad:** 202111020508 05/05/2021 IN
- (71) **Solicitante:** PI INDUSTRIES LTD. [IN]
- (72) **Inventor:** Santosh Shridhar Autkar [IN]; Alexander G.M. Klausener [DE]; Nitin Shivanna Kore [IN]; Maruti N Naik [IN]; Sonali Swarnkar [IN]; Paras Raybhan Bhujade [IN]
- (74) **Agente/apoderado:** GUSTAVO LARROSA DE BRUN (179)
- (54) **Título:** NUEVOS COMPUESTOS HETEROCÍCLICOS CONDENSADOS PARA COMBATIR HONGOS FITOPATÓGENOS.

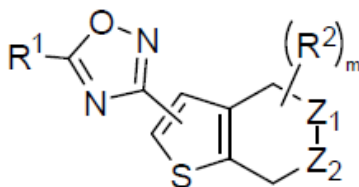

- (57) **Resumen:** La presente invención se refiere a compuestos de fórmula (I), en donde, R_1 , R_2 , Z_1 , Z_2 y m son como se definen en la descripción detallada, y a un proceso para preparar dichos compuestos de fórmula (I). La presente invención también se refiere al uso de compuestos de fórmula (I) para combatir hongos fitopatógenos y a un método para combatir hongos fitopatógenos.

(19) Dirección Nacional de la Propiedad Industrial – URUGUAY

(12) Invención

(11) UY a/039756

- (51) **Clasificación Internacional:** C 07D 409/14(2006.01), C 07D 403/14(2006.01), C 07D 417/14(2006.01), C 07D 471/08(2006.01), C 07D 487/04(2006.01), A 61K 31/439(2006.01), A 61K 31/44(2006.01), A 61K 31/4412(2006.01), A 61K 31/47(2006.01), A 61K 31/496(2006.01), A 61K 31/506(2006.01), A 61K 31/519(2006.01), A 61K 31/4365(2006.01), A 61K 31/433(2006.01), A 61K 31/4245(2006.01), A 61K 31/4178(2006.01), A 61K 31/381(2006.01), A 61K 31/4035(2006.01), A 61P 35/00(2006.01), A 61P 37/00(2006.01)// A 61P 35/00, 37/00
- (22) **Fecha de presentación:** 05/05/2022
- (30) **Datos de prioridad:** US 63/184,439 05/05/2021 US
- (71) **Solicitante:** BIOGEN MA INC. [US] y C4 Therapeutics, Inc. [US]
- (72) **Inventor:** Brian T. HOPKINS [US]; Isaac MARX [US]; Marta NEVALAINEN [US]; Kevin M. GUCKIAN [US]; Xinpeng CHENG [CN]; Eric STEFAN [FR]; Jae Young AHN [US]; Morgan Welzel O'SHEA [US]; Jeremy L. YAP [US]; Corey Don ANDERSON [US]
- (74) **Agente/apoderado:** STELLA MARINA WENG POLICICCHIO (218)
- (54) **Título:** COMPUESTOS PARA LA DEGRADACIÓN DIRIGIDA DE LA TIROSINA CINASA DE BRUTON

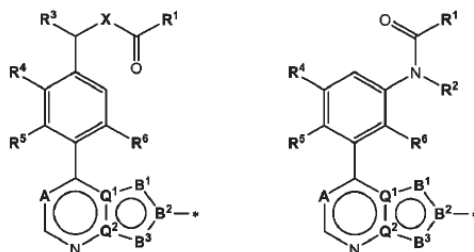

- (57) **Resumen:** Esta descripción se refiere a compuestos de Fórmula (A) o una sal farmacéuticamente aceptable de los mismos, capaces de activar la ubiquitinación selectiva de las proteínas Btk a través de las vías de ubiquitina-proteasoma (UPP) y provocar la degradación de las proteínas, Btk BTK—L—DSM (A) donde DSM es un resto de señalización de degradación que se enlaza covalentemente al enlazador L, L es un enlazador que enlaza covalentemente BTK a DSM, y BTK es un resto de unión a Btk representado por la fórmula (I) o la fórmula (II) que está enlazado covalentemente al enlazador L:

(19) Dirección Nacional de la Propiedad Industrial – URUGUAY**(12) Invención****(11) UY a/039757**

- (51) **Clasificación Internacional:** A 01N 25/22(2006.01), A 01N 37/42(2006.01), C 05G 3/90(20200101)
- (22) **Fecha de presentación:** 05/05/2022
- (30) **Datos de prioridad:** 17/534,320 23/11/2021 US y 63/184,963 06/05/2021 US
- (71) **Solicitante:** STOLLER ENTERPRISES, INC. [US]
- (72) **Inventor:** Ritesh Bharat Sheth [US]; Francisco Javier Maldonado Gonzalez [CL]; Maria Dollar [PK]
- (74) **Agente/apoderado:** JUAN LAPENNE DE SALTERAIN (211)
- (54) **Título:** SOLUCIONES LÍQUIDAS NO ACUOSAS ESTABLES DE ÁCIDO S-(+)-ABSCÍSICO

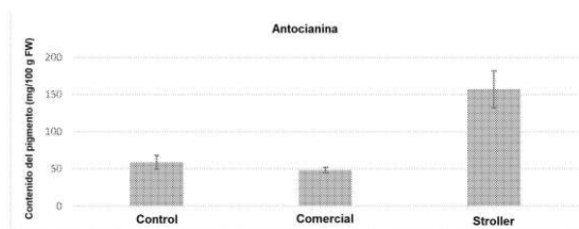

- (57) **Resumen:** Las soluciones líquidas no acuosas estables del ácido S-(+)-abscísico (S-ABA) generalmente se obtienen sin el uso de una cantidad eficaz de un antioxidante y/o un absorbedor de luz ultravioleta con el ácido S-(+)-abscísico. En una realización preferida, las soluciones líquidas no acuosas estables del ácido S-(+)-abscísico (S-ABA) incluyen al menos un disolvente orgánico, tal como al menos un polietilenglicol, al menos un glicol, y/o al menos una lactamida y/o al menos un pentanoato.

(19) Dirección Nacional de la Propiedad Industrial – URUGUAY**(12) Invención****(11) UY a/039758**

- (51) **Clasificación Internacional:** A 61K 31/513(2006.01), A 61K 31/519(2006.01), A 61P 35/00(2006.01)// A 61P 35/00
- (22) **Fecha de presentación:** 06/05/2022
- (30) **Datos de prioridad:** 63/184,941 06/05/2021 US y 63/212,316 18/06/2021 US
- (71) **Solicitante:** AMGEN INC. [US]
- (72) **Inventor:** Brett E. HOUK [US]; Fernando Antonio ALVAREZ-NUNEZ [US]; Jiemin BAO [US]; Sai Prasanth CHAMARTHY [US]; Namita SAWANT [IN]; Naga DUGGIRALA [IN]; Yuan-Hon KIANG [US]; Angela OLSOFSKY [US]; Dominick Paul DAURIO [US]
- (74) **Agente/apoderado:** FABIANA PENADES (216)
- (54) **Título:** FORMULACIÓN DE SOTORASIB

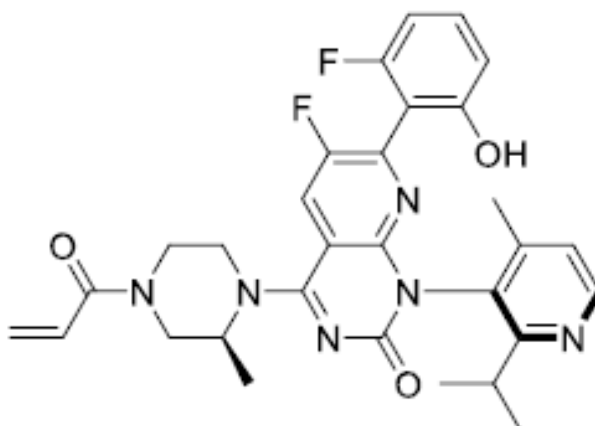

- (57) **Resumen:** La divulgación proporciona formulaciones que comprenden sotorasib (1), un diluyente, un disgregante y un lubricante. (1)

(19) Dirección Nacional de la Propiedad Industrial – URUGUAY**(12) Invención****(11) UY a/039759**

- (51) **Clasificación Internacional:** A 01N 43/713(2006.01), A 01N 43/72(2006.01), A 01N 43/74(2006.01), A 01N 43/86(2006.01), A 01P 13/00(2006.01), C 07D 257/02(2006.01), C 07D 263/18(2006.01), C 07D 265/10(2006.01), C 07D 413/10(2006.01), C 07D 413/12(2006.01)// A 01P 13/00, C 07D 263/18, 265/10
- (22) **Fecha de presentación:** 06/05/2022
- (30) **Datos de prioridad:** 2106554.5 07/05/2021 GB
- (71) **Solicitante:** SYNGENTA CROP PROTECTION AG [CH]
- (72) **Inventor:** BURTON, Paul Matthew [GB]; MITCHELL, Glynn [GB]; TAYLOR, Nicholas John [GB]; ARMSTRONG, Sarah [GB]
- (74) **Agente/apoderado:** JUAN LAPENNE DE SALTERAIN (211)
- (54) **Título:** N-(tetrazol-5-il)-fenilcarboxamidas y su uso como herbicidas

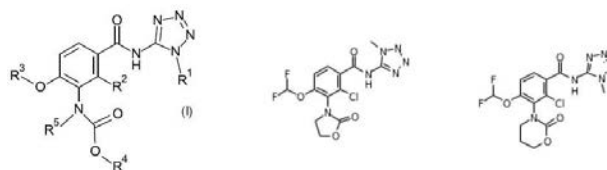

- (57) **Resumen:** La presente invención se refiere a compuestos de fórmula (I); o a una sal agronómicamente aceptable de los mismos, en donde R1, R2, R3, R4 y R5 son tal como se describen en el presente documento. La invención se refiere además a composiciones que comprenden dichos compuestos, a métodos para controlar la maleza usando dichas composiciones, al uso de los Compuestos de Fórmula (I) como herbicida, y métodos de preparación de dichos compuestos.

(19) Dirección Nacional de la Propiedad Industrial – URUGUAY**(12) Invención****(11) UY a/039760**

- (51) **Clasificación Internacional:** A 01N 43/16(2006.01), A 01N 43/713(2006.01), A 01N 43/40(2006.01), A 01N 43/18(2006.01), A 01P 13/00(2006.01), C 07D 405/12(2006.01), C 07D 401/12(2006.01), C 07D 335/02(2006.01), C 07D 309/10(2006.01), C 07D 257/02(2006.01), C 07D 409/12(2006.01), C 07D 211/98(2006.01)// A 01P 13/00, C 07D 211/98, 309/10, 335/02
- (22) **Fecha de presentación:** 06/05/2022
- (30) **Datos de prioridad:** 202111021131 10/05/2021 IN
- (71) **Solicitante:** SYNGENTA CROP PROTECTION AG [CH]
- (72) **Inventor:** BURTON, Paul Matthew [GB]; RAJAN, Ramya [IN]; TAYLOR, Nicholas John [GB]; ARMSTRONG, Sarah [GB]
- (74) **Agente/apoderado:** JUAN LAPENNE DE SALTERAIN (211)
- (54) **Título:** N-(TETRAZOL-5-IL)FENILCARBOXAMIDAS Y SU USO COMO HERBICIDAS

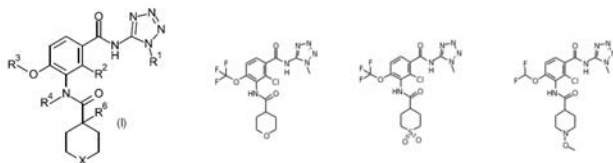

- (57) **Resumen:** La presente invención se refiere a compuestos de fórmula (I): o a una sal agronómicamente aceptable de los mismos, en donde X, R1, R2, R3, R4 y R6 son tal como se describen en el presente documento. La invención se refiere además a composiciones que comprenden dichos compuestos, a métodos para controlar la maleza usando dichas composiciones, al uso de los Compuestos de Fórmula (I) como herbicida, y métodos de preparación de dichos compuestos.

(19) Dirección Nacional de la Propiedad Industrial – URUGUAY

(12) Invención

(11) UY a/039761

- (51) **Clasificación Internacional:** C 07D 407/14(2006.01), C 07D 403/14(2006.01), C 07D 401/04(2006.01), C 07D 487/10(2006.01), C 07H 19/12(2006.01), A 61K 31/53(2006.01), A 61K 31/496(2006.01), A 61K 31/437(2006.01), A 61K 31/407(2006.01), A 61K 31/351(2006.01), A 61K 31/706(2006.01), A 61P 35/00(2006.01)// A 61P 35/00
- (22) **Fecha de presentación:** 10/05/2022
- (30) **Datos de prioridad:** PCT/CN2021/093036 11/05/2021 CN; PCT/CN2021/100523 17/06/2021 CN y PCT/CN2022/086004 11/04/2022 CN
- (71) **Solicitante:** Janssen Pharmaceutica NV [BE]
- (72) **Inventor:** CAI, Wei [CN]; PANDE, Vineet [NL]; LIU, Yingtao [CN]; LIU, Lianzhu [CN]; FU, Liqiang [CN]; LI, Ming [CN]; FANG, Lichao [CN]; DENG, Xiangjun [CN]; DARVILLE, Nicolas Freddy J [BE]; DAI, Xuedong [US]; XU, Yanping [US]; NG, Alicia Tee Fuay [US]; DASKALAKIS, Nikki [US]; GUTTKE, Christina Diane [US]; KWON, Min Chul [KR]; FERRANTE, Lucille Angela [US]; PACKMAN, Kathryn Elizabeth [US]; PIETSCH, Eva Christine [US]; PHILIPPAR, Ulrike [DE]; VERHULST, Tinne Ann J [BE]; BHOGAL, Balpreet [US]; SUN, Yu [US]; THURING, Johannes Wilhelmus J. [NL]; QUEROLLE, Olivier Alexis Georges [FR]
- (74) **Agente/apoderado:** DIEGO DUFRECHU RODRIGUEZ (192)
- (54) **Título:** TERAPIAS COMBINADAS

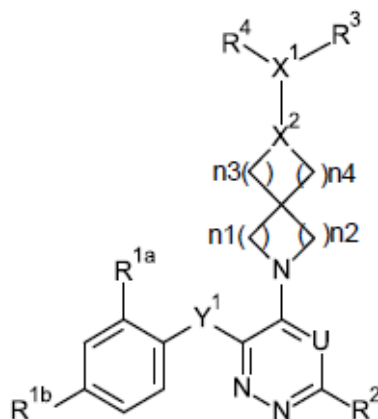

- (57) **Resumen:** Se divulgan combinaciones que comprenden una cantidad terapéuticamente eficaz de un inhibidor de menina-MLL de Fórmula (I), o una sal farmacéuticamente aceptable o un solvato de este; y una cantidad terapéuticamente eficaz de un inhibidor de BCL-2; y opcionalmente una cantidad terapéuticamente eficaz de al menos un agente antineoplásico diferente. También se divulgan métodos para tratar a un sujeto al que se le ha diagnosticado un trastorno hematopoyético utilizando tales combinaciones. Los compuestos se representan mediante la Fórmula (I) como sigue: , donde R^{1a}, R^{1b}, R², R³, R⁴, U, Y₁, X₁, X₂, n₁, n₂, n₃ y n₄ se definen en la presente.

(19) Dirección Nacional de la Propiedad Industrial – URUGUAY

(12) Invención

(11) UY a/039762

- (51) **Clasificación Internacional:** C 07D 401/10(2006.01), C 07D 403/14(2006.01), C 07D 487/10(2006.01), A 61K 31/4725(2006.01), A 61K 31/4196(2006.01), A 61K 31/407(2006.01), A 61K 31/53(2006.01), A 61P 35/00(2006.01)// A 61P 35/00
- (22) **Fecha de presentación:** 11/05/2022
- (30) **Datos de prioridad:** PCT/CN2021/093036 11/05/2021 CN; PCT/CN2021/100522 17/06/2021 CN; PCT/CN2021/100523 17/06/2021 CN; PCT/CN2022/086003 11/04/2022 CN y PCT/CN2022/086004 11/04/2022 CN
- (71) **Solicitante:** Janssen Pharmaceutica NV [BE]
- (72) **Inventor:** CAI, Wei [CN]; ALI-AHMED, Sumia [GB]; LIU, Yingtao [CN]; LIU, Lianzhu [CN]; FU, Liqiang [CN]; LI, Ming [CN]; FANG, Lichao [CN]; DENG, Xiangjun [CN]; DARVILLE, Nicolas Freddy J [BE]; DAI, Xuedong [US]; XU, Yanping [US]; NG, Alicia Tee Fuay [US]; DASKALAKIS, Nikki [US]; GUTTKE, Christina Diane [US]; KWON, Min Chul [KR]; FERRANTE, Lucille Angela [US]; PACKMAN, Kathryn Elizabeth [US]; PIETSCH, Eva Christine [US]; PHILIPPAR, Ulrike [DE]; VERHULST, Tinne Ann J [BE]; BHOGAL, Balpreet [US]; SUN, Yu [US]; PANDE, Vineet [NL]; THURING, Johannes Wilhelmus J. [NL]; QUEROLLE, Olivier Alexis Georges [FR]
- (74) **Agente/apoderado:** DIEGO DUFRECHU RODRIGUEZ (192)
- (54) **Título:** TERAPIAS COMBINADAS

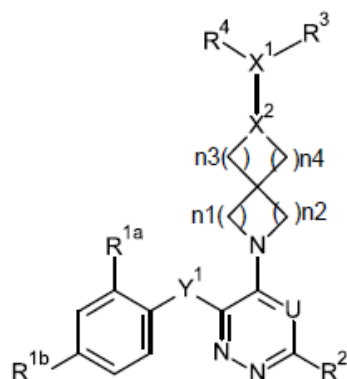

- (57) **Resumen:** Se divulgan combinaciones que comprenden una cantidad terapéuticamente eficaz de un inhibidor de menina-MLL de Fórmula (I), o una sal farmacéuticamente aceptable o un solvato de este, y una cantidad terapéuticamente eficaz de al menos un agente terapéutico diferente que es un agente hipometilante, un inhibidor de citidina·desaminasa, un agente intercalante de ADN, un análogo de pirimidina, un análogo de purina, un inhibidor de cinasas, un inhibidor de CD20, un inhibidor de IDH, un agente inmunomodulador o un inhibidor de DHODH. También se divulgan métodos para tratar a un sujeto diagnosticado con cáncer utilizando tales combinaciones.

(19) Dirección Nacional de la Propiedad Industrial – URUGUAY

(12) Invención

(11) UY a/039763

- (51) **Clasificación Internacional:** A 01N 43/40(2006.01), A 01N 43/56(2006.01), A 01N 43/78(2006.01), A 01N 43/80(2006.01), A 01P 3/00(2006.01), A 01P 7/00(2006.01), C 07D 231/12(2006.01), C 07D 261/04(2006.01), C 07D 277/22(2006.01), C 07D 417/14(2006.01)// A 01P 3/00, 7/00
- (22) **Fecha de presentación:** 11/05/2022
- (30) **Datos de prioridad:** 202111021922 15/05/2021 IN
- (71) **Solicitante:** PI INDUSTRIES LTD [IN]
- (72) **Inventor:** Santosh Shridhar Autkar [IN]; Gajanan Shanbaug [IN]; Ravikumar Suryanarayana Saragur [IN]; Hagalavadi M Venkatesha [IN]
- (74) **Agente/apoderado:** GUSTAVO LARROSA DE BRUN (179)
- (54) **Título:** COMPOSICIÓN AGROQUÍMICA NOVEDOSA QUE COMPRENDE COMPUESTOS DE PIPERIDIN-TIAZOL

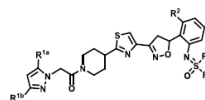
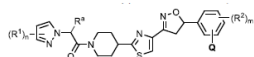

- (57) **Resumen:** La presente invención desvela una novedosa composición agroquímica que comprende al menos un compuesto de la fórmula (I_i) como un componente (1) en donde, R₁, R₂, R_a, Q, n y m son como se definen en la descripción detallada y al menos un compuesto fungicidamente activo (II) y/o al menos un compuesto insecticidamente activo (III_i) como un componente (2). La presente invención desvela además un método de control de microorganismos, tales como hongos fitopatógenos y bacterias de las plantas, y/o plagas de insectos y ácaros usando la composición agroquímica según invención.

(19) Dirección Nacional de la Propiedad Industrial – URUGUAY**(12) Invención****(11) UY a/039764**

- (51) **Clasificación Internacional:** C 07D 471/04(2006.01), A 61K 31/4375(2006.01), A 61K 31/496(2006.01), A 61P 35/00(2006.01)// A 61P 35/00
- (22) **Fecha de presentación:** 11/05/2022
- (30) **Datos de prioridad:** PCT/CN2021/093346 12/05/2021 CN
- (71) **Solicitante:** JACOBIO PHARMACEUTICALS CO., LTD. [CN]
- (72) **Inventor:** Wei LONG [CN]; Lei ZHANG [CN]; Xinrui FAN [CN]; Sujing LI [CN]; Chaojie DANG [CN]; Amin LI [CN]
- (74) **Agente/apoderado:** GONZALO FERNÁNDEZ SECCO (34)
- (54) **Título:** NOVEDOSAS FORMAS DEL COMPUESTO I Y USO DE LAS MISMAS

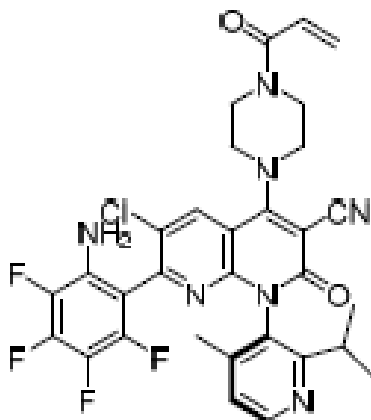

- (57) **Resumen:** La presente invención se relaciona con novedosas formas del Compuesto I y uso de las mismas, en donde, el compuesto es (M)-4-(4-acriloilpiperazin-1-il)-7-(2-amino-3,4,5,6-tetrafluorofenil)-6-cloro-1-(2-isopropil-4-metilpiridin-3-il)-2-oxo-1,2-dihidro-1,8-naftiridin-3-carbonitrilo.

(19) Dirección Nacional de la Propiedad Industrial – URUGUAY**(12) Invención****(11) UY a/039765**

- (51) Clasificación Internacional:** A 01H 1/00(2006.01), A 01H 5/00(2018.01), A 01N 65/00(2009.01)
- (22) Fecha de presentación:** 12/05/2022
- (30) Datos de prioridad:** 202110514749.8 12/05/2021 CN
- (71) Solicitante:** BEIJING DABEINONG BIOTECHNOLOGY CO., LTD. [CN]
- (72) Inventor:** BAO, Xiaoming [US]; YU, Caihong [CN]; TAO, Qing [CN]; SONG, Qingfang [CN]; XIAO, Xiang [CN]
- (74) Agente/apoderado:** JUAN LAPENNE DE SALTERAIN (211)
- (54) Título:** Uso de protoporfirinógeno oxidasa para conferir tolerancia a un herbicida en plantas
- (57) Resumen:** La presente invención está relacionada con el uso de una protoporfirinógeno oxidasa, y en particular con un método para conferir tolerancia a un herbicida inhibidor de PPO en una planta usando una protoporfirinógeno oxidasa derivada de procariotas, y sus usos. Casi todas las protoporfirinógeno oxidasas PPO1-PPO14 muestran alta resistencia a cuatro veces la concentración de campo de oxifluorfenó, saflufenacilo y flumioxazina, y a dos veces la concentración de campo de sulfentrazona, por lo cual tienen amplias perspectivas de aplicación en plantas.

(19) Dirección Nacional de la Propiedad Industrial – URUGUAY

(12) Invención

(11) UY a/039766

- (51) **Clasificación Internacional:** A 01N 43/713(2006.01), A 01N 43/824(2006.01), C 07D 257/06(2006.01), C 07D 271/113(2006.01)
- (22) **Fecha de presentación:** 12/05/2022
- (30) **Datos de prioridad:** 2106945.5 14/05/2021 GB
- (71) **Solicitante:** SYNGENTA CROP PROTECTION AG [CH]
- (72) **Inventor:** EMERY, Katie [GB]; BURTON, Paul Matthew [GB]
- (74) **Agente/apoderado:** JUAN LAPENNE DE SALTERAIN (211)
- (54) **Título:** N-(TETRAZOL-5-IL)FENILCARBOXAMIDAS Y SUS USOS COMO HERBICIDAS

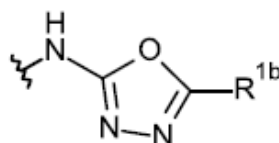
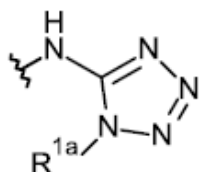
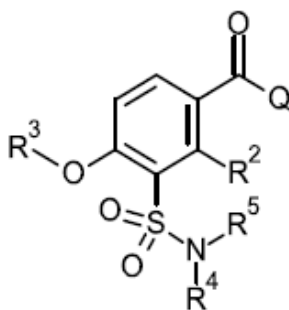

- (57) **Resumen:** La presente invención se refiere a compuestos de fórmula (I) o una sal agrónomicamente aceptable de los mismos, en donde Q, R2, R3, R4 y R5 son tal como se definen en el presente documento. La invención se refiere, además, a composiciones que comprenden dichos compuestos, a métodos de control de malezas que utilizan dichas composiciones, al uso de compuestos de fórmula (I) como herbicida y a compuestos intermedios utilizados en la producción de dichos compuestos.

(19) Dirección Nacional de la Propiedad Industrial – URUGUAY**(12) Invención****(11) UY a/039768**

- (51) **Clasificación Internacional:** C 07K 16/28(2006.01), C 12N 15/85(2006.01), C 12N 5/10(2006.01), C 12P 21/08(2006.01), A 61K 39/395(2006.01)
- (22) **Fecha de presentación:** 13/05/2022
- (30) **Datos de prioridad:** 2021-081913 13/05/2021 JP y 2021-086534 21/05/2021 JP
- (71) **Solicitante:** Foundation for Biomedical Research and Innovation at Kobe [JP]; NATIONAL INSTITUTES OF BIOMEDICAL INNOVATION, HEALTH AND NUTRITION [JP] y Meiji Seika Pharma Co., Ltd. [JP]
- (72) **Inventor:** HONJO, Tasuku [JP]; OHTA, Akio [JP]; TAJIMA, Masaki [JP]; TOKUMARU, Yosuke [JP]; NAGATA, Satoshi [JP]; SUZUKI, Kensuke [JP]; FUKUSHIMA, Takayoshi [JP]; KAMADA, Haruhiko [JP]
- (74) **Agente/apoderado:** JUAN LAPENNE DE SALTERAIN (211)
- (54) **Título:** ANTICUERPO AGONISTA DE PD-1 HUMANO Y COMPOSICIÓN FARMACÉUTICA QUE COMPRENDE EL ANTICUERPO PARA TRATA
- (57) **Resumen:** [PROBLEMA DE SOLUCIÓN DE LA INVENCION] Buscar las condiciones necesarias para que los anticuerpos contra PD-1 humana tengan actividad agonista, y establecer un anticuerpo agonista optimizado basado en las condiciones necesarias y aplicar el anticuerpo agonista como terapia para enfermedades inflamatorias humanas. [MEDIOS PARA RESOLVER EL PROBLEMA] Un anticuerpo agonista de PD-1 humana o un fragmento funcional del mismo, en donde el anticuerpo o un fragmento funcional del mismo se une al dominio #7 de PD-1 humana como se muestra en la SEQ ID NO: 9. [DIBUJO SELECCIONADO] Fig. 19

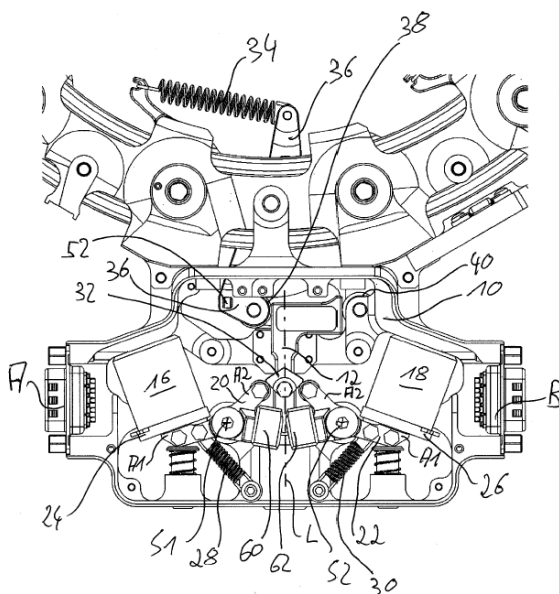
(19) Dirección Nacional de la Propiedad Industrial – URUGUAY**(12) Invención****(11) UY a/039773****(51) Clasificación Internacional:****(22) Fecha de presentación:** 19/05/2022**(30) Datos de prioridad:** 21176976.5 31/05/2021 EP**(71) Solicitante:** EXOLAUNCH GmbH [DE]**(72) Inventor:** Dmitriy BOGDANOV [UZ]; Peter SCHWARZ [AT]; Denis BEDEROV [DE]; Johannes GRUBER [AT]; Sergey POLYAK [DE]; Peter WIMMER [AT]**(74) Agente/apoderado:** GUSTAVO LARROSA DE BRUN (179)**(54) Título:** APARATO DE LIBERACIÓN

(57) Resumen: Un aparato de liberación para liberar un satélite comprende un émbolo de liberación que se puede precargar mediante un resorte de liberación y que se sujeta en una posición precargada mediante dos palancas de pivote de dos brazos que pueden pivotar en torno a un eje de pivote respectivo, en donde cada palanca de pivote se puede sujetar contra una fuerza de un resorte en una posición de sujeción mediante un elemento de liberación.

(19) Dirección Nacional de la Propiedad Industrial – URUGUAY**(12) Invención****(11) UY a/039775**

- (51) **Clasificación Internacional:** A 47G 19/22(2006.01), A 47J 41/00(2006.01)
(22) **Fecha de presentación:** 19/05/2022
(30) **Datos de prioridad:** 17/327,583 21/05/2021 US
(71) **Solicitante:** PACIFIC MARKET INTERNATIONAL, LLC [US]
(72) **Inventor:** Myron Wang [CN]; John Paul Leimone [US]
(74) **Agente/apoderado:** Gustavo Fischer Fleurquin (94)
(54) **Título:** RECIPIENTE PARA BEBIDAS DE DOBLE PARED Y MÉTODO PARA FORMARLO

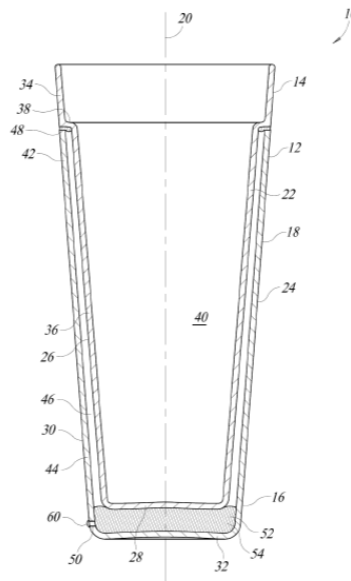

- (57) **Resumen:** Un recipiente de vidrio para bebidas de doble pared, que tiene una porción externa inferior de pared lateral del cuerpo interior en acoplamiento hermético con una pared externa del cuerpo interior para definir una cavidad interior para bebidas, una porción externa inferior de pared lateral del cuerpo exterior en acoplamiento hermético con una pared externa del cuerpo exterior.

(19) Dirección Nacional de la Propiedad Industrial – URUGUAY**(12) Invención****(11) UY a/039780**

- (51) **Clasificación Internacional:** A 01N 43/836(2006.01), A 01P 3/00(2006.01), C 07D 271/06(2006.01), C 07D 413/04(2006.01)// A 01P 3/00
- (22) **Fecha de presentación:** 20/05/2022
- (30) **Datos de prioridad:** 202111023436 26/05/2021 IN
- (71) **Solicitante:** PI INDUSTRIES LTD. [IN]
- (72) **Inventor:** Santosh Shridhar Autkar [IN]; Maruti N Naik [IN]; Paras Raybhan Bhujade [IN]; Alexander G.M. Klausener [DE]
- (74) **Agente/apoderado:** GUSTAVO LARROSA DE BRUN (179)
- (54) **Título:** COMPOSICIÓN FUNGICIDA QUE CONTIENE COMPUESTOS DE OXADIAZOL

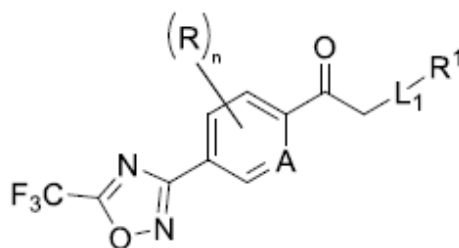

- (57) **Resumen:** La presente invención divulga una nueva composición fungicida que comprende al menos un compuesto de fórmula (I) o una sal agrícolamente aceptable del mismo como componente (1), en donde, R, A, L1, R1 y n son como se han definido en la descripción detallada y al menos otro compuesto activo como componente (2). La presente invención desvela además un método para controlar o prevenir la infestación de plantas por microorganismos fitopatógenos y el uso de la composición fungicida de acuerdo con la invención para el tratamiento de semillas.

(19) Dirección Nacional de la Propiedad Industrial – URUGUAY**(12) Invención****(11) UY a/039789**

- (51) **Clasificación Internacional:** A 01N 43/56(2006.01), A 01N 43/80(2006.01), C 07D 231/16(2006.01), C 07D 413/12(2006.01)
- (22) **Fecha de presentación:** 27/05/2022
- (30) **Datos de prioridad:** 202121023677 27/05/2021 IN
- (71) **Solicitante:** UPL LIMITED [IN]
- (72) **Inventor:** KINI, Prashant Vasant [IN]; GANDHALE, Sopan Nagnath [IN]; MAHAJAN, Vijay [IN]; GULVE, Sandip Sahebrao [IN]; SENGUPTA, Debasish [IN]
- (74) **Agente/apoderado:** GUSTAVO LARROSA DE BRUN (179)
- (54) **Título:** INTERMEDIO NOVEDOSO PARA LA PREPARACIÓN DE PIROXASULFONA.

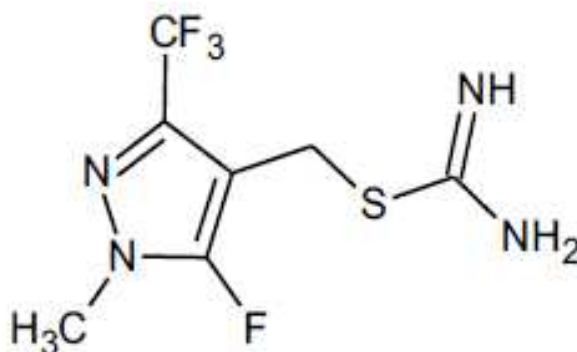

- (57) **Resumen:** La presente invención se refiere a un compuesto novedoso de fórmula (I) o su sal. La presente invención se refiere además al proceso para la preparación de Piroxasulfona usando dicho compuesto de fórmula (I) o su sal.

(19) Dirección Nacional de la Propiedad Industrial – URUGUAY**(12) Invención****(11) UY a/039793**

- (51) **Clasificación Internacional:** C 07D 471/14(2006.01), A 61K 31/501(2006.01), A 61K 31/4985(2006.01), A 61K 31/506(2006.01), A 61P 31/20(2006.01)// A 61P 31/20
- (22) **Fecha de presentación:** 01/06/2022
- (30) **Datos de prioridad:** PCT/CN2021/097848 02/06/2021 CN y PCT/CN2022/090237 29/04/2022 CN
- (71) **Solicitante:** Janssen Sciences Ireland Unlimited Company [IE]
- (72) **Inventor:** KUDUK, Scott D [US]; Lu, Chunliang [CN]; Deng, Gang [CN]; Liu, Lianzhu [CN]; Li, Xiaoyu [CN]; Liu, Zhiguo [CN]; Deratt, Lindsey Graham [US]; Cheng, Zhanling [CN]; Grosse, Sandrine Céline [FR]; Vandyck, Koen [BE]; Jacoby, Edgar [BE]; Jonckers, Tim Hugo Maria [BE]; Raboisson, Pierre Jean-Maria Bernard [FR]; Tang, Bingqing [CN]
- (74) **Agente/apoderado:** DIEGO DUFRECHU RODRIGUEZ (192)
- (54) **Título:** DERIVADOS HETEROCÍCLICOS CONDENSADOS

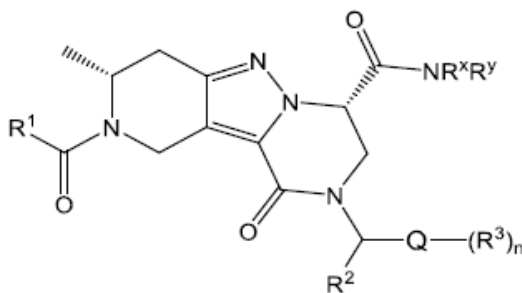

- (57) **Resumen:** La solicitud describe compuestos que son derivados heterocíclicos condensados, composiciones farmacéuticas que comprenden estos compuestos, procesos químicos para preparar estos compuestos y su uso en el tratamiento de enfermedades asociadas con una infección por VHB.

(19) Dirección Nacional de la Propiedad Industrial – URUGUAY**(12) Invención****(11) UY a/039794**

- (51) **Clasificación Internacional:** C 07D 413/14(2006.01), C 07D 403/14(2006.01), C 07D 401/14(2006.01), C 07D 417/14(2006.01), C 07D 471/14(2006.01), A 61K 31/497(2006.01), A 61K 31/4985(2006.01), A 61K 31/501(2006.01), A 61K 31/506(2006.01), A 61K 31/4427(2006.01), A 61K 31/427(2006.01), A 61K 31/4245(2006.01), A 61K 31/4196(2006.01), A 61K 31/41(2006.01), A 61K 31/415(2006.01), A 61P 31/20(2006.01)// A 61P 31/20
- (22) **Fecha de presentación:** 01/06/2022
- (30) **Datos de prioridad:** PCT/CN2021/097847 02/06/2021 CN y PCT/CN2022/090238 29/04/2022 CN
- (71) **Solicitante:** Janssen Sciences Ireland Unlimited Company [IE]
- (72) **Inventor:** KUDUK, Scott D [US]; Lu, Chunliang [CN]; Deng, Gang [CN]; Liu, Lianzhu [CN]; Li, Xiaoyu [CN]; Liu, Zhiguo [CN]; Deratt, Lindsey Graham – [US]; Cheng, Zhanling [CN]; Grosse, Sandrine Céline [FR]; Vandyck, Koen [BE]; Jacoby, Edgar [BE]; Raboisson, Pierre Jean-Maria Bernard [FR]; Jonckers, Tim Hugo María [BE]; Tang, Bingqing [CN]
- (74) **Agente/apoderado:** DIEGO DUFRECHU RODRIGUEZ (192)
- (54) **Título:** DERIVADOS HETEROCÍCLICOS CONDENSADOS

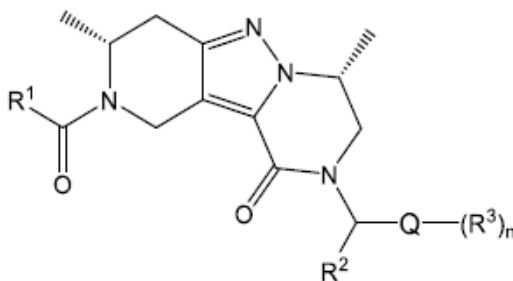

- (57) **Resumen:** La solicitud describe compuestos derivados heterociclos condensados, composiciones farmacéuticas que comprenden estos compuestos, procedimientos químicos para preparar estos compuestos y su uso en el tratamiento de enfermedades asociadas con la infección por VHB

(19) Dirección Nacional de la Propiedad Industrial – URUGUAY

(12) Invención

(11) UY a/039795

- (51) **Clasificación Internacional:** C 07D 471/04(2006.01), A 61K 31/55(2006.01), A 61K 31/437(2006.01), A 61P 35/00(2006.01), A 61P 3/10(2006.01), A 61P 3/08(2006.01)// A 61P 3/08, 3/10, 35/00
- (22) **Fecha de presentación:** 01/06/2022
- (30) **Datos de prioridad:** PCT/CN2021/097679 01/06/2021 CN y PCT/CN2022/085680 08/04/2022 CN
- (71) **Solicitante:** Janssen Pharmaceutica NV [BE]
- (72) **Inventor:** DEMIN, Samuël Dominique [BE]; EDWARDS, James Patrick [US]; QUEROLLE, Olivier Alexis Georges [FR]; LI, Ming [CN]; DENG, Xiangjun [CN]; DARVILLE, Nicolas Freddy J [BE]; DAI, Xuedong [US]; NG, Alicia Tee Fuay [US]; LIANG, Chao [CN]; PANDE, Vineet [NL]; THURING, Johannes Wilhelmus J. [NL]; HULPIA, Fabian [BE]; SUN, Zhen [CN]; ZHANG, Zhigao [CN]; DYUBANKOVA, Natalia Nikolaevna [BE]; JOUFFROY, Matthieu, Dominique [FR]; LEPRI, Susan [IT]; SCHEPENS, Wim Bert Griet [BE]; CAI, Wei [CN]
- (74) **Agente/apoderado:** DIEGO DUFRECHU RODRIGUEZ (192)
- (54) **Título:** DERIVADOS DE FENIL-1H-PIRROLO[2,3-c]PIRIDINA SUSTITUIDOS

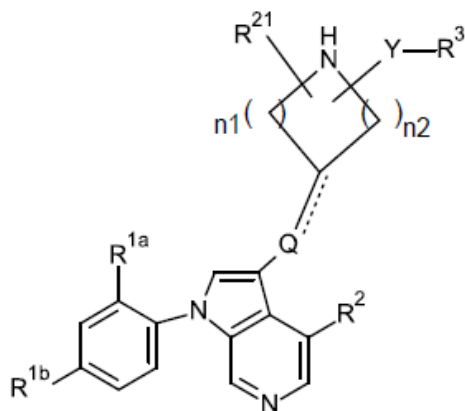

- (57) **Resumen:** La presente invención se refiere a agentes farmacéuticos útiles para la terapia y/o profilaxis en un mamífero, a una composición farmacéutica que comprende tales compuestos y a su uso como inhibidores de la interacción entre las proteínas menina y MLL útiles para tratar enfermedades tales como el cáncer, que incluye, sin carácter limitante, leucemia, síndrome mielodisplásico (SMD) y neoplasias mieloproliferativas (NMP); y diabetes.

(19) Dirección Nacional de la Propiedad Industrial – URUGUAY**(12) Invención****(11) UY a/039802**

- (51) Clasificación Internacional:** G 01N 21/31(2006.01), G 01N 21/3577(2014.01), G 01N 21/359(2014.01), G 01N 21/35(2014.01), D 21C 5/00(2006.01), D 21C 3/22(2006.01)
- (22) Fecha de presentación:** 06/06/2022
- (30) Datos de prioridad:** FI2021/050417 04/06/2021 FI
- (71) Solicitante:** UPM-Kymmene Corporation [FI]
- (72) Inventor:** Sami Turunen [FI]; Juha Tamper [FI]; Juha Seppä-Lassila [FI]; Vilho Nissinen [FI]; Meri Ventola [FI]
- (74) Agente/apoderado:** FABIANA PENADES (216)
- (54) Título:** MÉTODOS Y ARREGLOS PARA CONTROLAR LA HIDRÓLISIS ENZIMÁTICA MEDIANTE ESPECTROMETRÍA FTIR
- (57) Resumen:** Se divulga un método para controlar la hidrólisis en-zimática en un proceso de productos químicos derivados de biomasa que comprende realizar mediciones FTIR en los fluido de proceso, y controlar el valor de al me-nos un parámetro del proceso basándose en los resulta-dos FTIR obtenidos. Dichos resultados indican el con-tenido de carbohidratos en los fluidos del proceso. Dicho control del valor de parámetros del proceso se lleva a cabo para afectar en dicha hidrólisis enzimá-tica, la conversión de celulosa y hemicelulosa en carbohidratos monoméricos y/o el contenido relativo de lignina soluble en relación con los carbohidratos monoméricos.

(19) Dirección Nacional de la Propiedad Industrial – URUGUAY

(12) Invención

(11) UY a/039854

- (51) **Clasificación Internacional:** A 01N 43/40(2006.01), A 01N 43/54(2006.01), A 01N 43/58(2006.01), A 01N 43/836(2006.01), C 07D 271/06(2006.01), C 07D 401/04(2006.01), C 07D 403/04(2006.01)
- (22) **Fecha de presentación:** 13/07/2022
- (30) **Datos de prioridad:** 2021-117258 15/07/2021 JP
- (71) **Solicitante:** KUMIAI CHEMICAL INDUSTRY CO., LTD. [JP]
- (72) **Inventor:** TANAKA, Kosuke [JP]; HORINOUCI, Kento [JP]; KANEKO, Isao [JP]; YOKOCHI, Shunsuke [JP]; OE, Takuto [JP]
- (74) **Agente/apoderado:** GONZALO FERNÁNDEZ SECCO (34)
- (54) **Título:** DERIVADO DE FORMAMIDA Y AGENTE DE CONTROL HORTÍCOLA Y AGRÍCOLA PARA EL CONTROL DE ENFERMEDADES DE LA

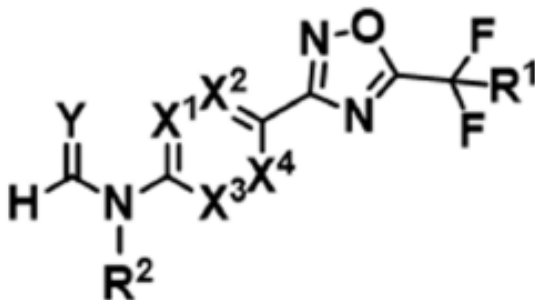

- (57) **Resumen:** Se proporciona un derivado de formamida o una sal del mismo, aceptado en la agricultura, y un agente de control agrícola y hortícola para el control de enfermedades de la planta que contiene el mismo como ingrediente activo, el derivado de formamida que está representado por la Fórmula [I] o similar, X1, X2, X3, y X4 cada uno representa independientemente un átomo de carbono o similar, Y representa un átomo de oxígeno o un átomo de azufre, R1 representa un átomo de halógeno, y R2 representa un átomo de hidrógeno, un grupo alquilo C1-C6, o similar.

(19) Dirección Nacional de la Propiedad Industrial – URUGUAY**(12) Invención****(11) UY a/039859**

- (51) **Clasificación Internacional:** B 65D 35/46(2006.01)
(22) **Fecha de presentación:** 14/07/2022
(30) **Datos de prioridad:** EP21185585.3 14/07/2021 EM
(71) **Solicitante:** Evonik Operations GmbH [DE]
(72) **Inventor:** Dr. Johannes Kamp [DE]; Marco Ryll [DE]; Dr. Eduardo Federico Arévalo Saade [DE]
(74) **Agente/apoderado:** FABIANA PENADES (216)
(54) **Título:** BANDEJAS CON VÁLVULAS EN COLUMNAS DE EXTRACCIÓN

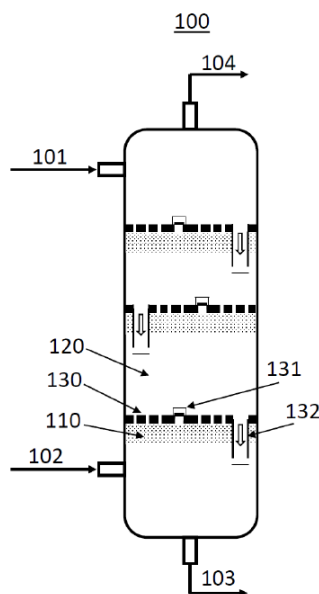

- (57) **Resumen:** La presente invención se refiere a un método de extracción y a una columna de extracción líquido-líquido a contracorriente para la extracción de una solución de trabajo oxidada que contiene peróxido de hidrógeno de un proceso de antraquinona. La columna de extracción comprende una pluralidad de bandejas de tamizado, donde al menos una de dichas bandejas de tamizado es una bandeja de tamizado con válvulas que comprende un tubo de bajada y al menos una válvula flotante que comprende un miembro de apertura elevable que cubre un orificio de válvula en la bandeja de tamizado con válvulas.

(19) Dirección Nacional de la Propiedad Industrial – URUGUAY**(12) Invención****(11) UY a/039940**

- (51) **Clasificación Internacional:** G 06Q 50/02(2012.01)
 (22) **Fecha de presentación:** 12/09/2022
 (30) **Datos de prioridad:** 63/245,184 16/09/2021 US
 (71) **Solicitante:** AMVAC Chemical Corporation [US]
 (72) **Inventor:** Richard L. RICE [US]; Kent W. JAMES [US]; Ulrich G. TROGELE [US]
 (74) **Agente/apoderado:** Juan Eduardo Vanrell Falcon (144)
 (54) **Título:** RASTREO SEGURO Y VERIFICABLE DE PRODUCTOS AGRÍCOLAS

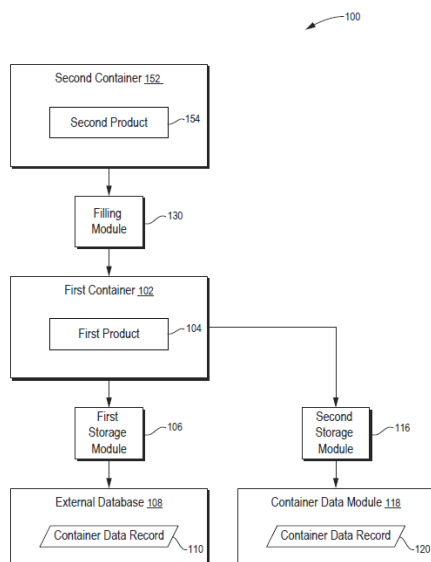

- (57) **Resumen:** Un sistema y método implementado por computadora para recopilar y almacenar datos relacionados con el producto almacenado en un contenedor. En respuesta al llenado del contenedor con el producto, los siguientes datos se almacenan en al menos un primer registro en una base de datos externa (como un libro contable distribuido, por ejemplo, blockchain): un tipo de producto del primer producto; una cantidad del primer producto llenado en el primer contenedor; una identidad única del primer contenedor; y una identidad única de un primer usuario del primer contenedor en el momento de llenar el primer contenedor con el primer producto. Los datos que representan una identidad única de un módulo de datos del contenedor en el contenedor se almacenan en el módulo de datos del contenedor. A medida que el contenedor se mueve, dispensa el producto y sufre cambios de posesión y propiedad, los datos que representan dichos eventos se almacenan en el libro contable distribuido y/o en el módulo de datos del contenedor. Como resultado, se genera un registro verificable de aplicación/consumo del producto dentro del contenedor.

(19) Dirección Nacional de la Propiedad Industrial – URUGUAY**(12) Invención****(11) UY a/039949**

- (51) **Clasificación Internacional:** A 01N 65/03(2009.01), C 12N 1/12(2006.01)
- (22) **Fecha de presentación:** 16/09/2022
- (30) **Datos de prioridad:** 10-2021-0125207 17/09/2021 KR
- (71) **Solicitante:** CJ CheilJedang Corporation [KR]
- (72) **Inventor:** KIM, Ji Young [KR]; SHIN, Won Sub [KR]; CHOI, Jung-Woon [KR]; KIM, Gyuree [KR]; KANG, Yuna [KR]; KANG, Hae-Won [KR]; OH, Youngjoo [KR]; JANG, Sunghoon [KR]
- (74) **Agente/apoderado:** VIRGINIA CERVIERI GHIOLDI (212)
- (54) **Título:** CEPA DE MICROALGA QUE TIENE EL EFECTO DE PROMOVER EL CRECIMIENTO DE LAS PLANTAS Y USO DE LA MISMA
- (57) **Resumen:** Nueva cepa de microalgas que promueven el crecimiento de plantas, y sus usos. La cepa *Chlorella vulgaris* CD02-3002 tiene tasa de crecimiento rápida y alta eficiencia fotosintética cuando se cultiva en presencia de gases de escape de fermentación, por lo que los gases debido a la fermentación microbiana pueden reducirse de manera eficiente. Cuando el cultivo o su sobrenadante se trata en las plantas, promueve el crecimiento de las plantas, se puede usar como fertilizante y se puede utilizar de manera controlada. Útil como tecnología de reducción de carbono, respetuosa con medio ambiente y alto uso industrial.

(19) Dirección Nacional de la Propiedad Industrial – URUGUAY**(12) Invención****(11) UY a/039980**

- (51) Clasificación Internacional:** A 01H 1/00(2006.01), A 01H 1/02(2006.01), A 01H 5/00(2018.01), A 01H 5/10(2018.01), C 07K 14/415(2006.01), C 12N 15/11(2006.01), C 12N 5/04(2006.01)
- (22) Fecha de presentación:** 21/02/2014
- (30) Datos de prioridad:** 2013900597 22/02/2013 AU; 2013900601 22/02/2013 AU; 2013900602 22/02/2013 AU; 2013900603 22/02/2013 AU; 2013900604 22/02/2013 AU; 2013900606 22/02/2013 AU; 2013900608 22/02/2013 AU y 35345 21/02/2014 UY
- (71) Solicitante:** AGRICULTURE VICTORIA SERVICES PTY LTD [AU] y DAIRY AUSTRALIA LIMITED [AU]
- (72) Inventor:** SPANGENBERG, German Carlos [AU]; FORSTER, John White [AU]; COGAN, Noel [AU]; PEMBLETON, Luke [AU]; SHINOZUKA, Hiroshi [AU]; PATRON, Nicola [AU]; RAN, Yidong [AU]
- (74) Agente/apoderado:** Juana Bacot (245)
- (54) Título:** Manipulación de la Auto-incompatibilidad en Plantas
-
- (57) Resumen:** La presente invención refiere a métodos de controlar la hibridación en plantas y de producir plantas híbridas. La presente invención también refiere a ácidos nucleicos codificando secuencias de aminoácidos de proteínas de auto-incompatibilidad (AI) en plantas, y el uso de las mismas para la manipulación de SI, incluyendo producción de semillas, en plantas, particularmente de la familia Poaceae. También refiere a kits, composiciones, constructos y vectores incluyendo dichos ácidos nucleicos, y polipéptidos relacionados, elementos regulatorios y métodos, y a la expresión de genes de reconocimiento de auto-gametos en plantas y a los ácidos nucleicos relacionados, constructos, marcadores moleculares y métodos de obtención.

SOLICITUDES DE DISEÑOS INDUSTRIALES

(19) Dirección Nacional de la Propiedad Industrial – URUGUAY

(12) Diseño Industrial

(11) UY s/004952

- (51) Clasificación Internacional:** B 65D 51/28(2006.01)07-05
(22) Fecha de presentación: 11/05/2022
(30) Datos de prioridad: 008755573 12/11/2021 EM
(71) Solicitante: Persan, S.A. [ES]
(72) Inventor: PALOMA GONZÁLEZ ARIAS [ES]
(74) Agente/apoderado: GONZALO FERNÁNDEZ SECCO (34)
(54) Título: CÁPSULAS CON DETERGENTE

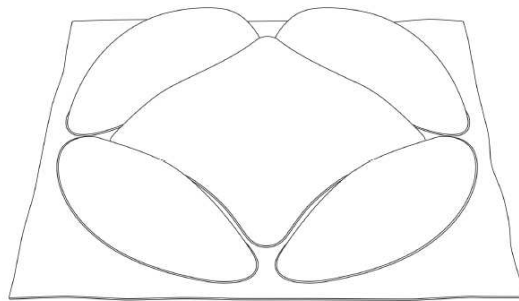

(57) Resumen: .

(19) Dirección Nacional de la Propiedad Industrial – URUGUAY**(12) Diseño Industrial****(11) UY s/004954**

- (51) **Clasificación Internacional:** B 01L 3/00(2006.01)24-01
(22) **Fecha de presentación:** 17/05/2022
(30) **Datos de prioridad:** 29/790,258 15/11/2021 US
(71) **Solicitante:** MAXCyte Inc. [US]
(72) **Inventor:** Nicholas CHOPAS [US]; Frank MODICA [US]
(74) **Agente/apoderado:** FABIANA PENADES (216)
(54) **Título:** EMPACADURA DE ELECTROPORACIÓN

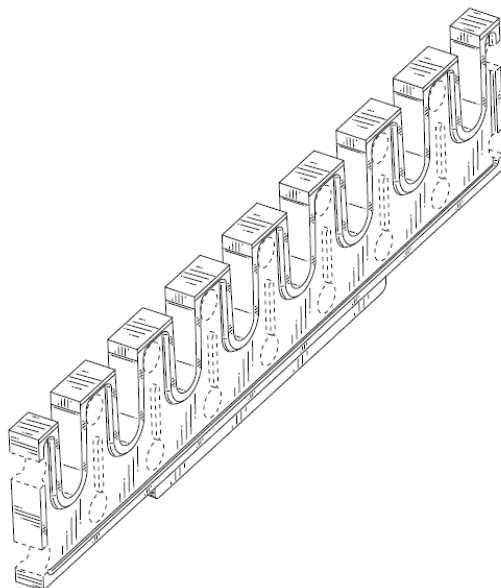

- (57) **Resumen:** El diseño ornamental de una empaquetadura de electroporación tal como se muestra y se describe.

(19) Dirección Nacional de la Propiedad Industrial – URUGUAY**(12) Diseño Industrial****(11) UY s/004964**

- (51) **Clasificación Internacional:** A 61J 17/00(2006.01)24-04
(22) **Fecha de presentación:** 23/06/2022
(30) **Datos de prioridad:** No. BR302021006610-6 23/12/2021 BR
(71) **Solicitante:** KUKA PRODUTOS INFANTIS LTDA. [BR]
(72) **Inventor:** JORGE LUIZ MORILLA [BR]
(74) **Agente/apoderado:** MATIAS CIKATO (201)
(54) **Título:** CONFIGURACION APLICADA EN CHUPETE

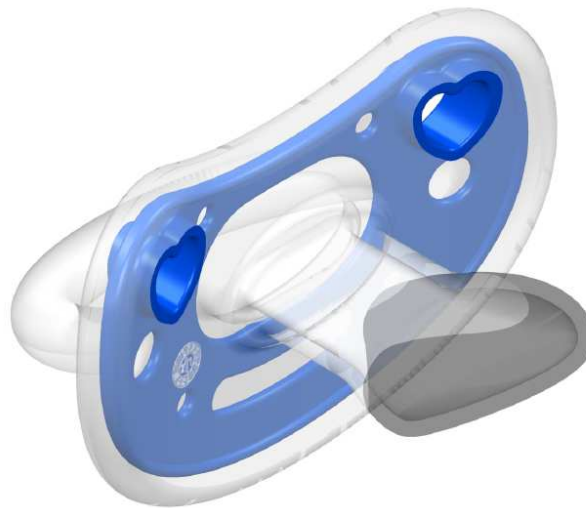

- (57) **Resumen:** Se reivindica el registro del diseño industrial tal y como se representa en el conjunto de figuras y presentado en la memoria descriptiva.

(19) Dirección Nacional de la Propiedad Industrial – URUGUAY**(12) Diseño Industrial****(11) UY s/005006**

- (51) **Clasificación Internacional:** H 01R 13/46(2006.01)13-03
(22) **Fecha de presentación:** 28/09/2022
(30) **Datos de prioridad:** K 008920110 1 29/03/2022 EM; K 008920110 3 29/03/2022 EM y K 008920110 5 29/03/2022 EM
(71) **Solicitante:** IDE ELECTRIC S.L. [ES]
(72) **Inventor:** Raquel Montañés Abos [ES]
(74) **Agente/apoderado:** FABIANA PENADES (216)
(54) **Título:** Caja de distribución

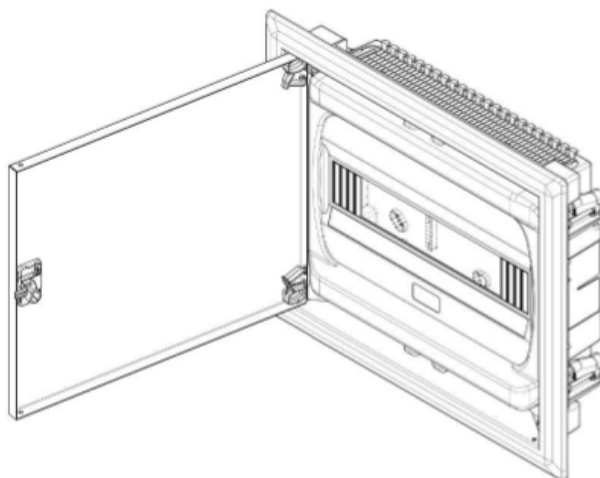

- (57) **Resumen:** Las características de los dibujos o modelos cuya protección se reivindica incluyen los motivos, las formas, la configuración y la ornamentación de cajas de distribución eléctricas

(19) Dirección Nacional de la Propiedad Industrial – URUGUAY**(12) Diseño Industrial****(11) UY s/005007**

- (51) **Clasificación Internacional:** H 01R 13/46(2006.01)13-03
(22) **Fecha de presentación:** 28/09/2022
(30) **Datos de prioridad:** K 008920110 1 29/03/2022 EM; K 008920110 3 29/03/2022 EM y K 008920110 5 29/03/2022 EM
(71) **Solicitante:** IDE ELECTRIC S.L. [ES]
(72) **Inventor:** Raquel Montañés Abos [ES]
(74) **Agente/apoderado:** FABIANA PENADES (216)
(54) **Título:** Caja de distribución

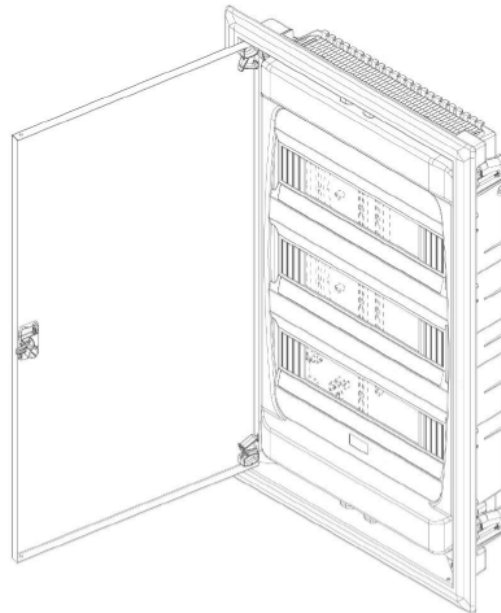

- (57) **Resumen:** Las características de los dibujos o modelos cuya protección se reivindica incluyen los motivos, las formas, la configuración y la ornamentación de cajas de distribución eléctricas

(19) Dirección Nacional de la Propiedad Industrial – URUGUAY**(12) Diseño Industrial****(11) UY s/005008**

- (51) **Clasificación Internacional:** H 01R 13/46(2006.01)13-03
(22) **Fecha de presentación:** 28/09/2022
(30) **Datos de prioridad:** K 008920110 1 29/03/2022 EM; K 008920110 3 29/03/2022 EM y K 008920110 5 29/03/2022 EM
(71) **Solicitante:** IDE ELECTRIC S.L. [ES]
(72) **Inventor:** Raquel Montañés Abos [ES]
(74) **Agente/apoderado:** FABIANA PENADES (216)
(54) **Título:** Caja de distribución

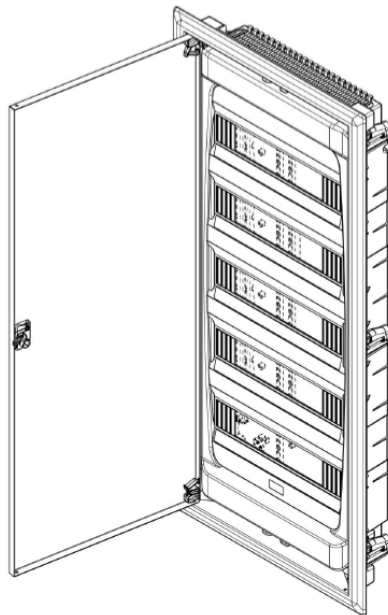

- (57) **Resumen:** Las características de los dibujos o modelos cuya protección se reivindica incluyen los motivos, las formas, la configuración y la ornamentación de cajas de distribución eléctricas

SOLICITUDES DE MODELOS DE UTILIDAD

(19) Dirección Nacional de la Propiedad Industrial – URUGUAY

(12) Modelo de Utilidad

(11) UY u/004831

- (51) **Clasificación Internacional:** G 10D 1/08(2006.01)
(22) **Fecha de presentación:** 13/12/2021
(30) **Datos de prioridad:**
(71) **Solicitante:** FILOCAMO, AUGUSTO ALEJANDRO [AR] y SPINA, DIEGO FERNANDO [AR]
(72) **Inventor:** SPINA, DIEGO FERNANDO [AR]; FILOCAMO, AUGUSTO ALEJANDRO [AR]
(74) **Agente/apoderado:** CARLOS E, SARLABÓS BUZÓ (BRAND UP S.A.S. 218974190018) (189)
(54) **Título:** GUITARRA DE VIAJE DE MÁSTIL HUECO Y RESONANTE

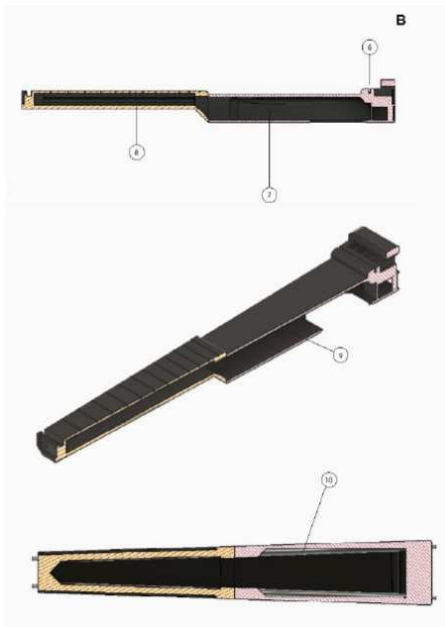

- (57) **Resumen:** Una guitarra de viaje conformada por una sola pieza, que consiste de una estructura hueca y rectilínea que cumple las funciones de mástil y de caja de resonancia, y un clavijero que consta de una cápsula fijadora de cuerdas con cuatro orificios. EL inferior –roscado- recibe un tornillo Allen que mueve dicha cápsula por la corredera, un nudo pasante para las cuerdas con tres orificios, y una corredera donde inserta la cápsula fijadora de las cuerdas

(19) Dirección Nacional de la Propiedad Industrial – URUGUAY**(12) Modelo de Utilidad****(11) UY u/004856**

- (51) **Clasificación Internacional:** E 03C 1/04(2006.01)
(22) **Fecha de presentación:** 12/10/2022
(30) **Datos de prioridad:**
(71) **Solicitante:** Henry Bladimir Vergara Perez [VE]
(72) **Inventor:** Paolo Marcelo de Franco Gauthier [UY]; Henry Bladimir Vergara Perez [VE]
(74) **Agente/apoderado:** Henry Bladimir Vergara Perez ()
(54) **Título:** Sistema de Fácil Instalación de Griferías Monomando

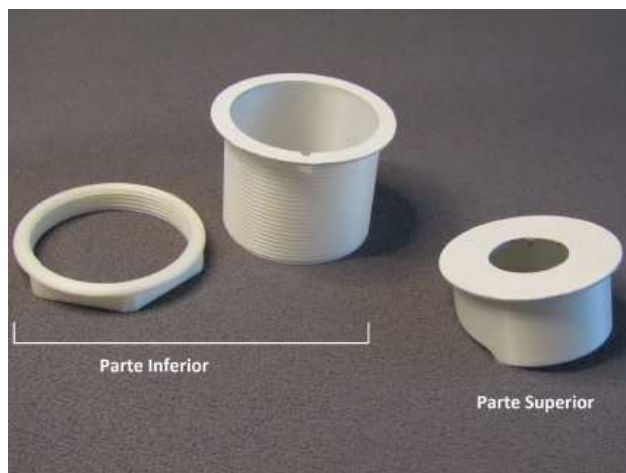

- (57) **Resumen:** Este dispositivo lleva el nombre de: SISTEMA DE FACIL INSTALACION DE GRIFERIAS MONOMANDO (SIFACIL). Es un dispositivo fabricado de Plástico (Polipropileno), donde se instala el grifo, las colillas de agua fría y caliente y luego el dispositivo se asegura por encima de la piletta de cocina. SIFACIL permite la instalación de forma cómoda y segura del Grifo y Colillas. Este sistema se puede instalar sobre la mesada o sobre la piletta de cocina.

(19) Dirección Nacional de la Propiedad Industrial – URUGUAY**(12) Modelo de Utilidad****(11) UY u/004858**

- (51) **Clasificación Internacional:** A 01J 9/04(2006.01)
(22) **Fecha de presentación:** 17/10/2022
(30) **Datos de prioridad:**
(71) **Solicitante:** Victor Alfredo Bonjour Garcia [UY]
(72) **Inventor:** Victor Alfredo Bonjour Garcia [UY]
(74) **Agente/apoderado:** Victor Alfredo Bonjour Garcia ()
(54) **Título:** Sistema para generar un circuito cerrado de agua helada para tambos

Uni Tambo

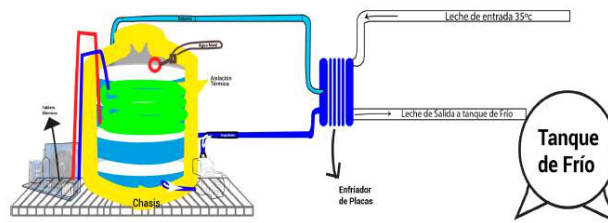

- (57) **Resumen:** Sistema de generación de agua helada para la optimización de enfriadores de placa en tambos

ÍNDICE POR TITULARES DE MARCAS

Titular	N° Exp	Marca
Abal Hermanos S.A.	542938	CORAL MIX
Abal Hermanos S.A.	542940	PURPLE DUO
Abal Hermanos S.A.	542933	PURPLE VISTA
Abal Hermanos S.A.	542935	BLUE BALL
Abal Hermanos S.A.	542936	BLUE SPIN
Abal Hermanos S.A.	542932	CORAL MOTION
Abbott Rapid Diagnostics International Subsidiary Unlimited Company	544186	PANBIO
ABC PROMOFARMA SRL	544159	DV (mixta)
ABC PROMOFARMA SRL	544158	DAVA PREMIUM NATURAL INGREDIENTS (mixta)
ABECH SAS	544330	ABECH
ACCIONA, S.A.	545009	acciona (mixta)
ACUAMAR SOCIEDAD ANONIMA	544448	HARDPC Tecnología + Innovación + Servicios (mixta)
ADANCARD S.A.	543768	ADANCARD
ADMINISTRACIÓN DE INSUMOS PARA LA SALUD, S.A. DE C.V.	543840	ELEMENTAL PERFORMANCE (mixta)
ADMINISTRACIÓN DE INSUMOS PARA LA SALUD, S.A. DE C.V.	543838	ELEMENTAL WELLNESS (mixta)
Administración Nacional de Telecomunicaciones (Antel)	543233	TV (mixta)
AG FOOD AND DRINKS MANAGEMENT LLC	544340	ALMACÉN DE PIZZAS (mixta)
AGROENZYMAS RETENUM, S.A.P.I. DE C.V.	544754	AdStrong (mixta)
AGROENZYMAS RETENUM, S.A.P.I. DE C.V.	544755	StressOff (mixta)
AGROENZYMAS RETENUM, S.A.P.I. DE C.V.	544757	ReactMAX (mixta)
AGROENZYMAS RETENUM, S.A.P.I. DE C.V.	544758	Bio Active (mixta)
Juan Manuel Ghio; Tobias Waisman; Tomas Augusto Waisman; Martin Julio Waisman y Agustin Alfredo Ghio	543915	MILANGA & CO. (mixta)
Agustin Fernandez	544265	De La Caperuza (mixta)
ALANO PEREIRA DA SILVA, LUCIANO	543096	ROBOT R CELESTE (mixta)
Alejandro Casaretto	543577	INGENIERIA COMERCIAL
Alejandro Casaretto	543575	SOLVENTA
Alejandro Fernandez	543279	UYMOTORS (mixta)
Alejandro Panuncio	542875	AREHUCAS
LUIS ARTAGAVEYTIA y ALFREDO ROSSINI	544662	Q´SOMOS. Elaboramos el sabor de tus comidas. Elabora y distribuye (mixta)
ALGEBRA S.R.L.	543961	AGRO EN PUNTA (mixta)
All Mor Gestao de Marcas E Produtos Ltda	544973	SVART (mixta)
All Mor Gestao de Marcas E Produtos Ltda	544970	T TECH ONE (mixta)
All Mor Gestao de Marcas E Produtos Ltda	544972	CODE AUTOMOTIVE (mixta)
ALTA GESTION S.A.	542542	AG CONSULTORES (mixta)
ALUMINIOS DEL URUGUAY S.A.	542706	(tridimensional)
Americold Chile S.A.	542198	ICESTAR (mixta)
Americold Chile S.A.	542201	ICESTAR (mixta)
Ana Elisa Toniotti	544641	Personal Travel - A donde quieras llegar (mixta)

Titular	N° Exp	Marca
ANA GRACIELA CIARLO PEREZ	544496	GROUT PEN (mixta)
ANA PAULA TELIZ	544287	CAFÉ DEL MERCADO (mixta)
Ana Paula Teliz	544285	CAFÉ DEL MERCADO
Analia Sanchez	540721	CASIANA (mixta)
Andermatt Group AG	544869	ATROVERDE
Andermatt Group AG	544975	INCLUDEX
Andermatt Group AG	544868	SPODOVEX
Andermatt Group AG	544870	NEMBAC
Andermatt Group AG	544977	BEAUVISAN
Andermatt Group AG	544871	PHOSBAC
Andrea Salvatierra	542890	CARDINALIS
ANDRES BELTRAN CAPUTI	543254	CHALA MADRE
ANDRES GALLO DUBOURG	542927	CANELONES TED ALIMENTA (mixta)
Angel Ghiazza	543900	Dos Orillas
Angela Mariela Dávila Toledo	544544	PEPE HAMBU (mixta)
Anilinas Colibrí C.E. E I.S.A.	543538	COLIBRÍ (mixta)
ANTIA MOLL Y CIA. S.A.	543167	EFASOLONA
ANTONIO PUIG, S.A.	543841	BOMBA
APPLE INC.	544397	FREEFORM
APPLE INC.	544974	(figurativa)
Apple Inc.	544763	PHOTONIC ENGINE
Aputure Imaging Industries Co.,Ltd.	544986	Sidus Link
AQUARIUS COSMETIC, S.L.U.	544983	MAGIC STUDIO
AQUARIUS COSMETIC, S.L.U.	544980	MARTINELIA (mixta)
AQUARIUS COSMETIC, S.L.U.	544982	AQC FRAGRANCES
AQUARIUS COSMETIC, S.L.U.	544979	IDC INSTITUTE (mixta)
Archsourcing SRL	544080	/slantis
ARGEMA S.A.	544095	SPORTACE BICYCLE COMPONENTS (mixta)
Ezequiel Mayo y Ariel Mayo	544747	FILGO ALLOY (mixta)
Arizaga y moreno srl	543426	Alfabrownie "juan querés merengue?"
Arizaga y moreno srl	543894	Y no hay chance
Arizaga y moreno srl	543423	GÜACHO (mixta)
Arizaga y moreno srl	543943	Monda Sana
ASATUL S.A.	543365	ASATUL (mixta)
Asistencial Medica Departamental de Maldonado - IAMPP	544274	ONE SEGURO MÉDICO CANTEGRIL (mixta)
Asociación Uruguaya de Fútbol	543626	AUF IMPULSA (mixta)
AUTECO MOBILITY S.A.S.	544927	OGS GLOBAL SPARES (mixta)
AUTODESK, INC.	543931	AUTODESK
AVIR PHARMA INC.	541762	ONAKTA
Bajaj Auto Limited	544640	BAJAJ CT
BALLINA, LILIANA ALICIA	543948	BALLINA
BANCA DE CUBIERTA COLECTIVA DE QUINIELAS DE MONTEVIDEO	544882	WALTER (mixta)
BANCO SANTANDER S.A.	544220	GREEN FRIDAY (mixta)
BANCO SANTANDER S.A.	544103	GREEN FRIDAY
Bausch & Lomb Incorporated	542244	BAUSCH + LOMB MOISTURESEAL
Bayer Aktiengesellschaft	543686	(figurativa)
BAZUL S.A.	543343	AKESSE
BAZUL S.A.	543345	FIJI
BEATRIZ PAEZ MARTINEZ	544123	LA CARTUJA ELABORACIÓN ARTESANAL FRESCA TODOS LOS DÍAS (mixta)
BECRAFT SRL	543071	MAREŚIA (mixta)
Belgicast Internacional S.L.	543628	BELGICAST
BENCH SAS	543549	OKKO (mixta)

Titular	N° Exp	Marca
BENESSERE S.A.	543618	DAHI (mixta)
Benjamín García Hamilton	544516	García Hamilton
BINFOL S.A.	544405	Be Docta (mixta)
BIO THERM	543382	BIO THERM BLUE PRO RETINOL
BIZBOX S.A.S.	544457	ALÓ ACCESORIOS (mixta)
BIZBOX S.A.S.	544458	FOXBOX (mixta)
Bladinor S.A.	543257	GEOTAREAS
BLUE STAR GROUP S.A.	543645	ISADORA (mixta)
BLUE STAR GROUP S.A.	543648	TODOMODA (mixta)
BODEGAS ESMEERALDA S.A.	543554	PASARISA
BODEGAS ESMEERALDA S.A.	543553	ALTALAND
BODEGAS Y VIÑEDOS FAMILIA PASSADORE S.A.S.	543556	BODEGAS Y VIÑEDOS FAMILIA PASSADORE (mixta)
BODEGAS Y VIÑEDOS FAMILIA PASSADORE S.A.S.	544035	FAMILIA PASSADORE
Boehringer Ingelheim Vetmedica GmbH	544947	FENCOVIS (mixta)
Boehringer Ingelheim Vetmedica GmbH	543425	FENCOVIS
BONDUELLE Société anonyme	544102	BONDUELLE (mixta)
BOTICA COMERCIAL FARMACEUTICA LTDA.	544559	BOTICOLLECTION
BOTICA COMERCIAL FARMACEUTICA LTDA.	544558	O BOTICÁRIO MATCH
BOTICA COMERCIAL FARMACEUTICA LTDA.	544557	LIZ O BOTICÁRIO
BOTICA COMERCIAL FARMACEUTICA LTDA.	544556	EGEO O BOTICÁRIO
BOTICA COMERCIAL FARMACEUTICA LTDA.	544555	BOTI.SUN O BOTICÁRIO
BOTICA COMERCIAL FARMACEUTICA LTDA.	544554	ELYSÉE O BOTICÁRIO
BOTICA COMERCIAL FARMACEUTICA LTDA.	544553	MAKE B. O BOTICÁRIO
BOTICA COMERCIAL FARMACEUTICA LTDA.	544552	ZAAD
BOTICA COMERCIAL FARMACEUTICA LTDA.	543278	BOTI BABY
BOTICA COMERCIAL FARMACEUTICA LTDA.	544550	FLORATTA O BOTICÁRIO
Brandt Consolidated, Inc.	543275	BRANDT SEEDZONE
Breeders and Packers Uruguay SA	543518	GRAN CARNE NATURAL (mixta)
Breeders and Packers Uruguay SA	543516	GRAN CARNE (mixta)
BRENER, DARÍO y BRENER, MARTÍN	543848	EL FUERTE
Brum Costa Abogados S.A.S.	543456	ComplianceDay
BRUMA CAFÉ S.A.S.	543904	BRUMA
BTL Argentina SRL	543798	HIFEM
BTL Industries	543796	EMFRACTIONAL
BTL Industries	543795	EMGLOW
BTL Industries	543797	HIFES
Bumbu Rum Company LLC	544818	(figurativa)
Bumbu Rum Company LLC	543985	BUMBU
BYD Company Limited	544355	ZEAL
BYD Company Limited	544899	BYD (mixta)
Cable Video Uruguay Ltda	543684	IMPECABLE (mixta)
Calçados Pegada Nordeste Ltda.	544902	PEGADA PGD P PEGADA (mixta)
CALIPO S.A.	542985	CROWDER

Titular	N° Exp	Marca
CALIPO S.A.	542986	CROWDER FINANCIAMIENTO COLECTIVO (mixta)
CAPPETTA CELLI, ÁLVARO ANDRÉS	543412	DOÑA AGUSTINA
CAPRICO FRUTAL SAS	544886	Capricho Frutal - Bar de jugos (mixta)
CARABALLO PEREZ DIEGO FERNANDO, AMENGUAL SAAVEDRA SANTIAGO Y OTROS SOCIEDAD DE HECHO	542949	WHITE MONKEY (mixta)
CARLOS SANTIAGO WILKINS ESCOBAR	544584	U INVIERTO EN URUGUAY (mixta)
Carl's Jr. Restaurants LLC	543482	CARL'S JR. (mixta)
Carl's Jr. Restaurants LLC	543465	CARL'S JR.
Carl's Jr. Restaurants LLC	543483	CARL'S JR. (mixta)
Carl's Jr. Restaurants LLC	543484	(figurativa)
CARMITUR SA	542874	BRAVA PANADERIA (mixta)
Carolina Herrera Ltd	544401	CHC (mixta)
Carolina Herrera Ltd	543839	CH PASIÓN
CARRASCO RUIZ DIAZ SANDRA MARIELA	544645	COCCO STORE & DESIGN (mixta)
CASA DI CONTI LTDA.	543769	MOINHO REAL
CASA DI CONTI LTDA.	543576	SAMBA
CASA TRES S.R.L.	543203	CASA TRES CONTACT CENTER (mixta)
CASARIEGO ECHEVARRÍA, FEDERICO	543130	TUAUTOUY (mixta)
Cash S.A.	543667	CASH PAY (mixta)
Castrol Limited	544492	ON (mixta)
Cavica SRL	544122	CAVICA SALUD LABORAL Y DEPORTIVA. (mixta)
Cecilia Peri	542907	LA ADORADA (mixta)
CEREALES PILAR S.A.	543135	REDZY (mixta)
Cesar Jose MAYO TEXIS	543826	URUPOWER (mixta)
CHENG SHIN RUBBER IND. CO., LTD	543776	CST (mixta)
CHENG SHIN RUBBER IND. CO., LTD.	543775	CST (mixta)
Chery Automobile Co., Ltd.	544924	JAECOO (mixta)
Chery Commercial Vehicle (Anhui) Co., Ltd.	543709	JETOUR (mixta)
China Tea Co., Ltd.	544609	(figurativa)
Christian Crocco	544856	ALADINO FIESTAS (mixta)
Christian Ferreira	544863	EL EXPRESSO SERVICIOS UTILITARIOS (mixta)
Citizen Watch Company of America, Inc. d/b/a Bulova	543665	BULOVA ICON
CJ ENM CO., LTD.	543195	MNET PLUS
CJ ENM CO., LTD.	543191	M+ (mixta)
CJ ENM CO., LTD.	543192	M+ (mixta)
CJ ENM CO., LTD.	543194	MNET PLUS
CLAUDIA BETTINA ANTOLA GONZALEZ	544683	CONSTELACIONES GENEALOGICAS
CLAUDIO VIERA	543222	EL PALACETE DE LA PIZZA (mixta)
Clinica Imagen SRL	544562	CLINICA IMAGEN (mixta)
Club Nacional de Football	542766	C.N.DEF. ACADEMIA NACIONAL ESCUELITA DE FÚTBOL (mixta)
COC & H COMÉRCIO DE PRODUTOS, PEÇAS E ACESSÓRIOS AUTOMOTIVOS EIRELI	543761	PETBRILHO (mixta)
COC & H COMÉRCIO DE PRODUTOS, PEÇAS E ACESSÓRIOS AUTOMOTIVOS EIRELI	543758	PRIME GRILL (mixta)
Cognizant Technology Solutions U.S. Corporation	544951	C COGNIZANT (mixta)

Titular	N° Exp	Marca
Cognizant Technology Solutions U.S. Corporation	544949	C (mixta)
COHN RYBAK, CINDY	543237	AM!GOS UY (mixta)
COLEGIO DE MARTILLEROS Y CORREDORES PUBLICOS DEL DEPARTAMENTO JUDICIAL DE SAN ISIDRO	544273	Liderprop (mixta)
COLEGIO NUEVA CULTURA	543629	COLEGIO NUEVA CULTURA MÉTODO LOGOSÓFICO (mixta)
COLIMAN S.A.	543763	M (mixta)
COMPAÑIA INDUSTRIAL DE TABACOS MONTE-PAZ S.A.	545032	ARKX (mixta)
COMPAÑIA PARAGUAYA DE LEVADURAS SOCIEDAD ANONIMA (COPALSA)	543951	COPALSA (mixta)
ConAgra Foods RDM, Inc.	543537	ARMOUR
CONFECCIONES SALOME LTDA	544760	FAJAS SALOME LA ORIGINAL (mixta)
Consorcio Comex, S.A. de C.V.	543274	TOP
Consorcio Comex, S.A. de C.V.	543178	COMEX
COOMANS TRADE IMPORT, BV	544752	CUADRILATA
COÖPERATIEVE RABOBANK U.A.	544858	RABOBANK (mixta)
COOPERATIVA NACIONAL DE PRODUCTORES DE LECHE (CONAPROLE)	545067	POLAR FOOD (mixta)
COOPERATIVA VINICOLA AURORA LTDA.	543878	SANGUE DE BOI (mixta)
CORBO PERCIVALE, NADIA	543785	RENT THE LOOK
CORREA ESPINOSA, GUILLERMO FABIÁN	544721	OFPE ORQUESTA FILARMÓNICA DE PUNTA DEL ESTE (mixta)
CORTEVA AGRISCIENCE LLC	544686	BEXOVELD
COVEDISA S.A.	545004	HOP (mixta)
COVISER S.A.S	543414	Diagnóstico y Soluciones. Servicios a medida. (mixta)
CRIBA URUGUAY S.A.	544190	CRIBA (mixta)
CRIBA URUGUAY S.A.	544191	CRIBA (mixta)
CRUFI S.A	545030	MAR DEL ESTE (mixta)
CRUSOE FOODS INDÚSTRIA, IMPORTAÇÃO E EXPORTAÇÃO LTDA.	543701	ATUM MY PROTEIN (mixta)
CYBER ASSIST SRL	543692	CYBER ASSIST (mixta)
DAGOBERTO BARCELLOS S/A.	544455	CAL CREM
DALIFORM GROUP S.r.l.	544369	daliform (mixta)
DANBET S.A.	543728	LA PERLA
DANIEL GUSTAVO FOJO	542910	LA OPORTUNIDAD (mixta)
DANIEL GUSTAVO FOJO	542912	LA OPORTUNIDAD (mixta)
DANIEL GUSTAVO FOJO	542913	LA OPORTUNIDAD (mixta)
Daniella Fuentes	542684	D'ALMA (mixta)
Dardo Curbelo	543572	Cueros del Litoral
Dario Ney Santurio Peñaloza	544045	CLIC! (mixta)
DART INDUSTRIES INC.	544940	BEAUTYWARE BY TUPPERWARE
DDC S.A.S.	544665	LIV DISTRICT CARRASCO (mixta)
DELAFOND VIERCI, SILVINA	543396	LA VIE EN ROSE (mixta)
DELIBRA S.A.	543717	COMBINATER
DELTAGROUP (URUGUAY) SOCIEDAD ANONIMA	543736	DELTAGROUP (mixta)
DEPPTO.COM SAS	542954	SEMANA DEL VINO ESTEÑO

Titular	N° Exp	Marca
DERUELA S.A.	543366	PULCRY
DERVON SOCIEDAD ANONIMA	544505	Inaterra (mixta)
DIAZ CARPINTIERI IGNACIO DANIEL	543693	joyeria cobra (mixta)
DIAZ DURANTE FRANCIS NICOLÁS	544523	SMART GYM SOFTWARE DE GESTIÓN DE SOCIOS (mixta)
DIGUY S.A.	543912	ENZALUXANE
DIPTYQUE S.A.S.	543974	DIPTYQUE
DIPTYQUE S.A.S.	543975	DIPTYQUE PARFUMEUR PARIS 34 BOULEVARD SAINT GERMAIN DIPTYQUE 34 BOULEVARD SAINT GERMAIN PARIS 5E (mixta)
DISA HOLDING ENERGÉTICO, S.L.U.	543322	DISA SENTÍ NUESTRA ENERGÍA (mixta)
Discover Financial Services	543557	DISCOVER (mixta)
Disney Enterprises, Inc.	544653	DISNEY MICKEY & CO. (mixta)
Disney Enterprises, Inc.	544654	(figurativa)
DISTRIBUIDORA DEL POLO SAS	542980	EUROFLEX
DISTRIBUIDORA DEL POLO SAS	544887	EURO JACK
DISTRIBUIDORA DEL POLO SAS	544889	TANGO
DISTRIBUIDORA DEL POLO SAS	542979	LEVELFLEX
Distribuidora Industrial de Surtidores Americanos Montevideo S.A.	543810	Fertec (mixta)
Distribuidora Industrial de Surtidores Americanos Montevideo S.A.	543819	Fertec Blue (mixta)
DOMINGO R. GHELFA	544855	Grow Creado por la Naturaleza (mixta)
DOMINO'S IP HOLDER LLC	544839	DOMINO'S PIZZA (mixta)
DUEY S.A.	544195	DUEY (mixta)
Dyneval Ltd	543859	DYNEVAL
Ecolab USA Inc.	543320	OASIS
EDGARDO LARMINY LÓPEZ	543678	L-L-L-L LARMINY (mixta)
Ediciones Santillana S.A.	543383	R RICHMOND (mixta)
EL GRAN ALBERTO S.A.S.	545068	EL BOLICHE "DE ALBERTO" (mixta)
ELDINAR S.A.	543984	O.TWO.O (mixta)
Emiliano Alberto Navajas Erramuspe	543129	MOMENTUM
TOMAS MEJIA y EMILIANO GABRIEL CAROPRESE	544091	TROWN OUTDOOR (mixta)
E-MOBILITY CENTER INC	543719	SUPERCOOL (mixta)
EMPRESAS CAROZZI S.A.	545064	CAROZZI
EMPRESAS CAROZZI S.A.	545066	CAROZZI
Ennismore International Management Limited	544203	ENNISMORE
Ennismore International Management Limited	544202	ENNISMORE (mixta)
EPOLTYR S.A.	544511	EPOLTYR REPRESENTANTE E IMPORTADOR (mixta)
ESTANCIA SANTA MANUELA S.A.	544018	LA LAGUNE
ESTANCIA SANTA MANUELA S.A.	543638	CERRO DE LA LUZ
ETINCAR S.A.	543363	ETINCAR
ETOSHA LTDA.	544400	PARMARELLA (mixta)
EUBIOSIS S.R.L.	543846	PAW CARE (mixta)
EUDIKA S.A.	543946	METABIX BIOTECH (mixta)
EUDIKA S.A.	543944	METABIX BIOTECH (mixta)
EUDIKA S.A.	543945	METABIX BIOTECH (mixta)
EUGENIO BIGLIAZZI E HIJOS S.R.L.	544830	BIPO TU CASA MÁS LINDA (mixta)
EUROCOMPUTER SRL	543633	ECODROP (mixta)
EUROFARMA URUGUAY S.A.	543869	ACIL PREVENT
EUROPEAN COSMETICS LIMITADA	544594	TSUNAMI ENERGY (mixta)
EUROPEAN COSMETICS LTDA	543411	BUFALO ROJO (mixta)

Titular	N° Exp	Marca
FABIAN ALONSO PEREDA	544059	CONTABILIBRE
Fabiana Cardozo	543265	(figurativa)
FABRICA DE PASTAS LA ESPECIALISTA S.A.	543730	MARCELLO
Fabrizio Anselmi	543337	HOTEL PLAZA DE TOROS
Fabrizio Anselmi	543336	HOTEL COLONIA NATURAL
Fabrizio De Santis Paciello	544406	VELOCIFERO
Fabrizio Turra	544323	DERHAUSEN
FALABELLA S.A.	544542	DECO LOVERS (mixta)
Federación Uruguaya de Reiki	542604	FEDERACIÓN URUGUAYA DE REIKI 2020 (mixta)
FEDERATION INTERNATIONALE DE L'AUTOMOBILE	544965	FORMULA E (mixta)
FERNANDEZ SCARONE MAURO GABRIEL Y FREIRE ALVAREZ MARIA VICTORIA SOCIEDAD DE HECHO	544678	KOVU (mixta)
Fernando Abdo	543288	VF (mixta)
Fernando Cruz Gonzalez	543087	UNI KA (mixta)
FERNANDO KONSTANTINOVICH GARCIA	543535	Don Rómulo
Diego Comesaña; Adolfo Pizzurno; Hijos de Pose hnos; Pablo Rodríguez; José Andrade y Fernando Vazquez	543403	PORFIADO VINO DE MESA (mixta)
FERNILAND S.A.	545021	ENCANTO HEALTHY FOOD (mixta)
FERREIRA CANELA JUAN JORGE	543339	AGROVAL (mixta)
FERRERO S.P.A.	543724	(figurativa)
FIDEICOMISO 17847/2021	543901	M MARINAS CARRASCO (mixta)
Filgueira y Garmendia SRL	543488	Bodega urbana
Filgueira y Garmendia SRL	543489	Bodega urbana
FINDARIN S.A.	544495	MIDINEROYA! (mixta)
FINTESSE S.A.	517633	LITORAL HEMP (mixta)
FINUY S.A.S	544447	Fin Mutual. El compromiso compartido (mixta)
First Hawk Street LLC	544500	CÉCRED
FitFlop Limited	543251	FITFLOP (mixta)
FKN TEXTIL LTDA.	543782	FAKINI (mixta)
FKN TEXTIL LTDA.	543783	P PLAY GROUND (mixta)
Florencia Pipolo	544263	NIPOLI (mixta)
FMC Corporation	544743	MAGIC
FNC SOCIEDAD ANONIMA	543221	SIDRA DEL VALLE
FORQUÍMICA AGROCIÊNCIA LTDA	544241	FORSPRAY
FRANCESCHI GUAREPERO MARIA DE LOS ANGELES	544486	ORIENTALSUSHI (mixta)
Franco Gilbbi Lagala Boggio	544127	EPI EL PRECIO IMPOSIBLE
FRENCH CONNECTION LIMITED	543885	FRENCH CONNECTION
FRENCH CONNECTION LIMITED	543889	FCUK
Frengo S.A.	544178	LONGO (mixta)
FRIGORIFICO CENTENARIO S.A.	544959	LINEA VEG DE ALIMENTOS CENTENARIO
Full Fortune Intellectual Limited	543994	HEY DUDE
Furukawa Electric LatAm S.A.	544109	FURUKAWA SOLUTIONS (mixta)
Furukawa Electric LatAm S.A.	544110	INFRASTRUCTURE FOR LIFE
Gabrielloni, Silvina Adriana	544143	SILUMA (mixta)
Galactic Innovations S.A.S	543935	THE MARS OBELISK FIRST INTERPLANETARY MONUMENT OF THE HUMAN RACE (mixta)
GALARRAGA, NESTOR FRANCISCO	543395	INTERNATIONAL TAEKWON-DO

Titular	N° Exp	Marca
		FEDERATION (mixta)
GALIPOGLU HIDROMAS HIDROLIK OTOMOTIV SANAYI VE TICARET ANONIM SIRKETI	543756	HMLIFT (mixta)
GAMMELLA RAIMUNDEZ, MARIANA	543209	EL CHIVITO DE ORO
Gano Excel Industries Sdn Bhd	544813	GE GANO EXCEL (mixta)
Gano Excel Industries Sdn Bhd	544811	GANO CAFÉ
GARAGE DIGITAL LTDA.	544264	MA
Gates Corporation	543181	VULCOPOWER II (mixta)
G.E.I. 1942 S.R.L	543461	GIOARI
GELATIERI S.A.	542868	CREMOLATTI GELATERIA. (mixta)
GENOMMA LAB INTERNACIONAL, S.A.B. DE C.V.	543372	POMADA DE LA CAMPANA
GENOMMA LAB INTERNACIONAL, S.A.B. DE C.V.	543374	GALAFLEX
GENOMMA LAB INTERNACIONAL, S.A.B. DE C.V.	543371	AFFAIR
GENOMMA LAB INTERNACIONAL, S.A.B. DE C.V.	543376	VANART
GENOMMA LAB INTERNACIONAL, S.A.B. DE C.V.	543481	GENEXPERTOS
GENTOS S.A.	544842	+ GEN PROTECT PLUS (mixta)
GENTOS S.A.	544838	ESCUELA DE PASTORES SEMBRAMOS CONOCIMIENTO (mixta)
GENTOS S.A.	544840	GENTOS GENTE DE PASTOS (mixta)
GEOPAGOS S.A.	545001	GEOPAGOS (mixta)
ANALIA SUCEL OXANDABARAT FACCIO y GISSEL OXANDABARAT FACCIO	543637	OXA DECO (mixta)
GlaxoSmithKline Consumer Healthcare (UK) IP Limited	544259	HALEON For Health. With Humanity. (mixta)
GLOBAL IN LAB SAS	544043	GLOBAL IN LAB (mixta)
GLOBAL IN LAB SAS	544044	GLOBAL IN LAB (mixta)
GLOBALPOWER PAGAMENTOS DIGITAIS LTDA.	543502	POWERCREDIT (mixta)
GLOBALPOWER PAGAMENTOS DIGITAIS LTDA.	543503	POWER PAYMENTS (mixta)
Golden Goose S.p.A.	542590	GOLDEN GOOSE
Golden Goose S.p.A.	544984	GOLDEN GOOSE
Golden Goose S.p.A.	544976	(figurativa)
Golden Goose S.p.A.	544981	(figurativa)
GOLD-SKY S.A.	544730	GOLD&SKY S.A.
GOLD-SKY S.A.	544729	GOLDSKY S.A.
Gramón Bagó de Uruguay S.A.	545054	B-GAN (mixta)
Grandfood Indústria e Comércio Ltda.	544734	PremieR (mixta)
gretel gonzalez	543289	REVERENDA SINCE 2020 (mixta)
GROUPEMENT DES LABORATOIRES FRANÇAIS/SORAS	544639	E (mixta)
GRUPO BIMBO S.A.B. DE C.V.	544250	(figurativa)
GRUPO BIMBO S.A.B. DE C.V.	543142	CRUAPAN
Grupo Bimbo, S.A.B. de C.V.	543710	ST. PIERRE (mixta)
GRUPO ORAL HOME S.A.S.	543822	ORAL HOME TU SONRISA NOS MUEVE (mixta)
GRUPO SEPTIEMBRE SAS	543682	MANSA KOMBUCHA (mixta)
Guangdong Beary Foodstuff Co., Ltd.	544809	Beary (mixta)

Titular	N° Exp	Marca
GUANGZHOU XAIRCRAFT TECHNOLOGY CO., LTD.	544860	XAG
Guemiper Srl.	544946	5,0 ORIGINAL (mixta)
GUINOT	543653	SUMMUM
Gulf Agency Company Limited	543867	GAC (mixta)
Hugo Cesar Benedetti San Pedro y Gustavo Gabriel Avakian	544271	GARBATELLA (mixta)
GUSTAVO MANUEL SOFOVICH	543526	POLEMICA EN EL BAR
GUSTAVO MANUEL SOFOVICH	543527	LA PELUQUERIA DE DON MATEO
Gustavo Regueira	543844	Gobhar Equipment (mixta)
HALTY VEGH MAXIMO	544872	ALFALFAPLUS (mixta)
Hangzhou Nuo Cheng Medical Instrument Co., Ltd	543924	LIWEN RF (mixta)
HANNA-BARBERA PRODUCTIONS, INC. (a Delaware Corporation)	544988	PEBBLES
Healux Co., Ltd.	544245	mayglory
Healux Co., Ltd.	544240	Femin Touch (mixta)
Healux Co., Ltd.	544244	mesoglory
Healux Co., Ltd.	544239	HealFusion (mixta)
HENDERSON & CIA. S.A.	543566	TIENDA INGLESA CIBER OFERTAS (mixta)
HENESA, LLC	543934	GALLET
Hernan Aguilar	543892	BROTA (mixta)
HIDROMECANICA LESA S.A.	544305	AQUAPRO (mixta)
HIDROMECANICA LESA S.A.	544306	AQUASHOP (mixta)
HIPRA HUMAN HEALTH, S.L.U.	544438	BIMERVAX
hi-tech hardware industry co.,ltd.	544501	h i-tech (mixta)
Holfmann Culture Art Co., Ltd.	544943	HOLFMANN (mixta)
Honeywell International Inc.	544825	UNISIM
HOUSE OF FULLER, S. DE R.L. DE C.V.	544720	CLINICARE BT EFFECT (mixta)
HOUSE OF FULLER, S. DE R.L. DE C.V.	544722	CLINICARE LUMINOUS (mixta)
HOUSE OF FULLER, S. DE R.L. DE C.V.	543821	PAUL HILL BLACK (mixta)
HOUSE OF FULLER, S. DE R.L. DE C.V.	543824	SCAPPARE ENERGY (mixta)
HOUSE OF FULLER, S. DE R.L. DE C.V.	543828	SCAPPARE RED (mixta)
HOUSE OF FULLER, S. DE R.L. DE C.V.	543832	NIGHT GLOW (mixta)
HOUSE OF FULLER, S. DE R.L. DE C.V.	544716	MAGNETIC THE MAN (mixta)
HOUSE OF FULLER, S. DE R.L. DE C.V.	544714	SPACIO HOLÍSTICO (mixta)
HOUSE OF FULLER, S. DE R.L. DE C.V.	544709	PINK BY CHIC GIRLS (mixta)
HOUSE OF FULLER, S. DE R.L. DE C.V.	543551	ARMAND DUPREE EAU SENSUELLE
HOUSE OF FULLER, S. DE R.L. DE C.V.	543820	POINT OF ACTION (mixta)
HOUSE OF FULLER, S. DE R.L. DE C.V.	543550	ARMAND DUPREE BLACK
HOUSE OF FULLER, S. DE R.L. DE C.V.	543555	ARMAND DUPREE IMPERIAL
HOUSE OF FULLER, S. DE R.L. DE C.V.	543552	SALVAGGIO X-TREME
HOUSE OF FULLER, S. DE R.L. DE C.V.	543834	DAILY STYLE EXPERTS (mixta)
HOUSE OF FULLER, S. DE R.L. DE C.V.	543830	DAILY STYLE (mixta)
HOUSE OF FULLER, S. DE R.L. DE C.V.	543827	SCAPPARE FLY (mixta)
HOUSE OF FULLER, S. DE R.L. DE C.V.	543825	PAUL HILL BLUE (mixta)
HOUSE OF FULLER, S. DE R.L. DE C.V.	543823	SCAPPARE (mixta)
HOUSE OF FULLER, S. DE R.L. DE C.V.	543818	SKIN SOLUTIONS ROYAL JELLY (mixta)
HOUSE OF FULLER, S. DE R.L. DE C.V.	544712	BIO WHITE RESULT (mixta)
HOUSE OF FULLER, S. DE R.L. DE C.V.	544711	CHIC GIRLS VIOLET (mixta)
HOUSE OF FULLER, S. DE R.L. DE C.V.	543547	SHANTUNG JAZMIN
HSIEH, JOSE ANTONIO	543444	UNA VIDA SANA NUTRILEZA UNA VIDA FELIZ (mixta)
IBARRURI PALERMO, GERARDO DANIEL	544380	ACTION FOR TALENT PRIORIDADES EN ACCIÓN (mixta)

Titular	N° Exp	Marca
IGNACIO DRAGONE	543088	DRATECH IMPERMEABILIZACIONES (mixta)
IGNACIO MARIA RODRIGUEZ TRAMBAUER	543253	RODBAUER (mixta)
IGNACIO MARIA RODRIGUEZ TRAMBAUER	543252	TOL-BIN (mixta)
Ignacio Peyran	542507	FORMATO (mixta)
IKIGAI GROWTH SAS	544697	IKIGAI IKIGAI GROWTH MARKETING (mixta)
ILUMINACION Y PAISAJE LTDA.	543743	URBANPLAY
Imiracle (HK) Limited	543428	ELFBAR (mixta)
INDAGRO S.A.	544193	INDAGRO (mixta)
INDUSTRIA FARBAT GR S.A.	543770	IMBU (mixta)
INDUSTRIA METALURGICA FRUM LTDA.	543720	FRUM (mixta)
INDUSTRIA Y COMERCIO SAN JOSÉ S.A.	544685	YERBA MATE San José (mixta)
Industrial West Cooperativa de Trabajo	543140	M1 MULTIESPACIO UNO (mixta)
INDUSTRIAS ALIMENTICIAS DEL PLATA S.A.	543437	LIBRE
INÉS FERNÁNDEZ	545040	alba ASSIST (mixta)
Infantozzi Materiales de Expresión Plástica S.A	542854	HOJA PINTORA (mixta)
INNOVACIONES DISRAS, S.L.	543793	OTOSTICK (mixta)
INSTITUTO DE PROMOCIÓN DE LA INVERSIÓN, LAS EXPORTACIONES DE BIENES Y SERVICIOS E IMAGEN PAÍS	543694	URUGUAY (mixta)
Instituto GCA SAS	543687	Creafinity (mixta)
INSTITUTO NACIONAL DE INVESTIGACION AGROPECUARIA (INIA)	543799	CRILU NATURALLY MERINO UY (mixta)
INSTITUTO PLAN AGROPECUARIO	544477	RED GAUCHO G (mixta)
INTENDENCIA DE COLONIA	544261	PLAZA DE TOROS REAL DE SAN CARLOS (mixta)
INTENDENCIA DE COLONIA	544260	PLAZA DE TOROS REAL DE SAN CARLOS
INTENDENCIA DE COLONIA	544262	(figurativa)
INTENDENCIA DE FLORIDA	543627	FESTIVAL DE LA INDEPENDENCIA FLORIDA (mixta)
INTENDENCIA DEPARTAMENTAL DE LAVALLEJA	543622	PROYECTO GEOPARQUE MANANTIALES SERRANOS (mixta)
INTENDENCIA DEPARTAMENTAL DE LAVALLEJA	543621	PROYECTO GEOPARQUE MANANTIALES SERRANOS (mixta)
INTENDENCIA DEPARTAMENTAL DE LAVALLEJA	543623	PROYECTO GEOPARQUE MANANTIALES SERRANOS (mixta)
INTENDENCIA DEPARTAMENTAL DE LAVALLEJA	543624	PROYECTO GEOPARQUE MANANTIALES SERRANOS (mixta)
INTERA BIOTECH S.A.	543817	DIADERM
INTERPARFUMS S.A.	544565	SOLFERINO
Intervet International B.V.	544403	MOMETAMAX ULTRA
Intervet International B.V.	543778	MASTI-SEAL
IP HOLDINGS UNLTD. LLC	544389	ECKO UNLTD. (mixta)
IP HOLDINGS UNLTD. LLC	544387	ECKO UNLTD. ENERGY DRINK (mixta)
IPSEN PHARMA S.A.S.	543515	SOMYNA
IPSEN PHARMA S.A.S.	543514	SOMAFORM
IRIGOITIA, FLORENCIA AYELEN y IRIGOITIA, MAYLEN PAMELA	544013	CIPITRIA (mixta)

Titular	N° Exp	Marca
IRMA BERNARDINA ALVAREZ GONZALEZ	544635	Irma Alvarez (mixta)
JAVIER OMAR LEDROS y GUIDO MARTÍN PIÑEIRO	544596	420
GUIDO MARTÍN PIÑEIRO y JAVIER OMAR LEDROS	544598	420
JAVIER OMAR LEDROS y GUIDO MARTÍN PIÑEIRO	544595	420
JAVIER OMAR LEDROS y GUIDO MARTÍN PIÑEIRO	544597	420
Javier Sartor	523371	LAS MILY
JAWHP, LLC	544303	JOSEPH ABOUD
JEREMY DALLAS WITMER	542508	EL CORRAL (mixta)
JGM Ltda	543215	ATG INFORMATICA (mixta)
JIANGXI ISUZU MOTORS CO.,LTD.	543448	JIM (mixta)
JOHNSON & JOHNSON	543327	CLEAN & CLEAR (mixta)
JOHNSON & JOHNSON	543933	VERSITIV
JOHNSON & JOHNSON	543752	CLEAN & CLEAR (mixta)
JOREMES SAS	544577	A AMADEUS (mixta)
jorge Braceiro	543950	(figurativa)
Jorge Collazo	543855	GA GRAJEZ GRAN AJEDREZ (mixta)
JORGE FERNANDEZ	543765	HULEBOL (mixta)
Marianna Rovira Criado; Silvina Carvalho y Jorge Simeone	544893	Festival Internacional JAZZ entre amigos (mixta)
José Benito Romero Sum	544115	Requiem Aeternam
JOSE LUIS GOMEZ	544098	ECOHOUSE (mixta)
JOSEFINA DIMET BERGER	543614	LE COSMÉTIQUE (mixta)
JOSEFINA DIMET BERGER	543474	ELOI LE COSMÉTIQUE (mixta)
JOTT MARKET & DISTRIBUTION	543455	JOTT (mixta)
JOTT MARKET & DISTRIBUTION	543439	JOTT (mixta)
JUAN BENZANO	543285	LA ESKISITA (mixta)
JUAN BENZANO	543283	LA ESKISITA (mixta)
Juan Correa	544058	MATESURU (mixta)
Juan Lara	543082	ACFIT ALMA CARIBE FITNESS (mixta)
Juan Luis BOUZA	544733	CAPELA MARBLING VERDE
JUAN MANUEL GUEREQUIZ S.A.S.	544987	LUCERNA (mixta)
Gastón Tarabal; José María Picerno y Juan Martín Ovalle	544931	c ReisaGroup (mixta)
JUAN PABLO MORELLATO	544941	ROTO DIESEL (mixta)
JULIO DAVID RIOS CORBO	544161	LAS VOCES DEL FÚTBOL
KAMASA KAILI UNIVERSO S.A.C	544985	ASKPRO (mixta)
KANTIRA S. A.	544912	Barbosa Tools (mixta)
Kasih Food Production Company	543721	MEZETE (mixta)
KAUNED SA	543999	FRUTISIMO (mixta)
KAUNED SA	543997	SOL DE SALTO (mixta)
KAUNED SA	543998	SOL DE SALTO (mixta)
KAUNED SA	544000	FRUTISIMO (mixta)
KAWASAKI MOTORS, LTD.	544428	(figurativa)
KENPORT S.A.	543504	KENPORT (mixta)
KOL PHARMA S.A.	544047	OMEDICAL (mixta)
KONARG PARTS LLC.	544402	KONECTA (mixta)
Konecta BTO, S.L.	543277	KONECTA (mixta)
Korzo Inc.	544864	KORZO
KOWEST S.A. (en trámite de cambio de nombre a SRK Consulting Uruguay S.A.)	544705	SRK CONSULTING (mixta)

Titular	N° Exp	Marca
KP URUGUAY SRL	544361	LA DESPENSA (mixta)
Kraft Foods Group Brands LLC	544038	MAXWELL HOUSE
Kraft Foods Group Brands LLC	544040	GEVALIA
KUMON INSTITUTE OF EDUCATION CO., LTD.	543791	KUMON CONNECT (mixta)
Kyndryl, Inc.	544517	KYNDRYL BRIDGE (mixta)
Kyndryl, Inc.	543330	KYNDRYL VITAL
LA TINKA S.A.	543972	TINKA (mixta)
LA TINKA S.A.	543973	TE APUESTO (mixta)
LABORATORIO GADOR S.A.	543595	MIRFEL
LABORATORIO LANODERM S.R.L.	543971	BELLISSIMA
LABORATORIO LIBRA S.A.	543438	VASOPROST
LABORATORIO LIBRA SOCIEDAD ANONIMA	543954	TACROSUP
LABORATORIO LIBRA SOCIEDAD ANONIMA	543662	MIDAPROST
LABORATORIOS HAYMANN S.A.	541949	LERCAPINA
LABORATORIOS PHERGAL S.A.	543331	E'LIFEXIR
LABORATORIOS RICHMOND S.A.C.I.F	543201	TRI-ZEVUVIR
LANYVEL S.A.	543284	COLIBRÍ (mixta)
laura rodriguez	542683	MIEL EL TANO 100% NATURAL (mixta)
Laureano Larrosa	544490	GATI BURGER A QUEMA ROPA (mixta)
LEADER MUSIC SA	543466	LA GRANJA DE ZENÓN (mixta)
Leandro Javier Elizeire Castro	543655	OM SHANTI VEGAN FOOD (mixta)
Lenovo (Beijing) Limited	545031	LOQ (mixta)
Lenovo (Singapore) Pte. Ltd.	544826	THINKPHONE
Lenovo (Singapore) Pte. Ltd.	543723	MAGIC BAY
LIDFOX S.A.	544740	MUUCONTROL (mixta)
LIFEWATCH ERIC	545010	LIFEWATCH ERIC TESSERACT (mixta)
Lucila Passerini y Liliana Noemi Foray	543166	COSTUMBRES ANDINAS (mixta)
LINCE S.R.L.	544759	LINCE S.R.L. VER MÁS ES VIGILAR MEJOR (mixta)
LINFAR S.R.L.	544399	LINFAR
LINK EV ELECTRIC VEHICLES INC	543713	LINK EV ELECTRIC VEHICLES (mixta)
LINNEA SA	545028	NIOSKIN (mixta)
LIVERPOOL INSTRUMENTOS E ACESSORIOS MUSICAIS EIRELI	545038	LIVERPOOL DRUMSTICKS (mixta)
L'OREAL	543450	LA NUIT TRÉSOR FLEUR DE NUIT LANCÔME (mixta)
L'OREAL	543111	FRUCTIS ADIÓS ESPONJADO
L'OREAL	543112	FRUCTIS KERATIN GLOW WATER
L'OREAL (U.K.) LIMITED	543457	COUTURE MINI CLUTCH (mixta)
LOTIZEN S.A.	543874	CENTROJAS
LOURENCO SEOANE DA COSTA	544412	YAQUIEROOTRO
LTA Soluciones S.R.L.	544139	SANMAX ecolight (mixta)
LTWHP, LLC	544096	WORKS (mixta)
LUC BELAIRE INTERNATIONAL LTD.	543988	LUC BELAIRE
Lucia Moran	543179	MACANUDO (mixta)
Luciana Urruty Frascarelli	542922	PEQUEÑA MOLE (mixta)
LUIS AGUSTIN PETRONIO CURROTTO	544489	BOICOT
LUIS GERMAN PEREZ CHOPITE	544027	PRONTO FLEX (mixta)
LUIS MAYOL	544181	MONTEVIDEO COVERS
LUMINOVA PHARMA CORPORATION GmbH	544391	PROTOPRAZOL
LUMINOVA PHARMA CORPORATION	544390	DEXLAFUZOL

Titular	N° Exp	Marca
GmbH		
LUMINOVA PHARMA CORPORATION GmbH	544393	KOLEKTA
LUMINOVA PHARMA CORPORATION GmbH	544394	LUMINEB
LUMINOVA PHARMA CORPORATION GmbH	544395	LUMINEB K
LUMINOVA PHARMA CORPORATION GmbH	544396	PERIECA
LUMINOVA PHARMA CORPORATION GmbH	544381	MINDRE H
LUMINOVA PHARMA CORPORATION GmbH	544382	MINDRE
Lynd Calcados Ltda.	543677	LYND (mixta)
Mabee Ranch, LLC	543034	MR (mixta)
Mabee Ranch, LLC	543033	MABEE RANCH
Magdalena Etchechuri	544327	Grace (mixta)
MAIDANA PIRIZ TAMARA Y PIRIZ BOTTARO DORIS EVELYNI SOCIEDAD DE HECHO	542945	MOTASUY EL PODER DE TU PELO (mixta)
Mailing Participações e Empreendimentos Ltda.	544969	CARMIM (mixta)
Maison de la Parfumerie S.A.	543335	AREX
MANEROL SAS	543324	SANAS
MANTRA S.A.	543219	ANTOJO
MAPLE VILA LTDA	544450	MV MAPLE VILA UN CUIDADO PARTICULAR (mixta)
Marcelo Alcina	544023	SANTA ANA
Marcelo Ferrari	545039	POLIFILMS
MARCELO MAISSONAVE	543792	F FITAHOLIC (mixta)
MARCOS ROHRER GARCIA	544958	GINGO
MARELLI COFAP DO BRASIL LTDA.	543139	COFAP (mixta)
maria de los angeles balzani	544814	Balzani Uruguay (mixta)
maria de los angeles balzani	544815	Dimafa regalos artesanales (mixta)
MARIA FRANCISCA ALENY LYS SANGMEISTER SARALEGUI	544002	LA CEVICHERÍA (mixta)
Maria Ines Rebella	544892	miau (mixta)
MARIA JOSE REY MORI	542897	MAJOREY (mixta)
MARIA VIRGINIA SAN MARTIN PEREIRA	544042	GENÉTICA MANANTIALES (mixta)
Maria Ximena Alvez	544607	ATELIER XIMENALVEZ (mixta)
Marian Silvana De León Pena	543155	SUN KISS (mixta)
MARIANA CASTIGLIONI PEREIRA	542552	DHAUS @ REAL ESTATE (mixta)
MARIELA ALFARO	544021	EL SECRETO CASA DE TE
MARIO TANZI S.A.	545053	TANZI (mixta)
Marisol Araujo	543165	ELMATE (mixta)
MARIZYME INC	544436	CYTOPRO
Martha Rosario Suarez Gonzales	544704	CASATEX
martin bonavita delafond	544606	Bitacora Bar Punta Del Diablo (mixta)
MARTIN DANIEL MOLINA COITIÑO	542423	MIMISU
MARTINOVIC ARANGUREN ALEXIS MATHIAS	544185	chequealo (mixta)
MARY KAY INC.	543529	MARY KAY EMBRACE
MARZUREL S.A.	544030	SALTO (mixta)
MAS NUTRICION S.A.	543393	NUTREMAS
MAS NUTRICION S.A.	543398	MONTENEVI

Titular	N° Exp	Marca
MAS NUTRICION S.A.	543384	MAS NUTRICION
MAS NUTRICION S.A.	543392	TARRAGONA
Maschinenfabrik Kemper GmbH & Co. KG	544132	KEMPER
Maschinenfabrik Kemper GmbH & Co. KG	544133	KEMPER (mixta)
MASTERSUM S.A.S.	544286	EDUS (mixta)
MASTERSUM S.A.S.	544288	EDUS (mixta)
MASTERSUM S.A.S.	544283	MASTERSUM (mixta)
MASTERSUM S.A.S.	544284	MASTERSUM (mixta)
MASTERSUM S.A.S.	544282	MASTERSUM (mixta)
MASTERSUM S.A.S.	544289	EDUS (mixta)
Mateo Vázquez Ordeix	543808	Alambres Tacuarembó (mixta)
MATHIAS BARTRAM	544164	LA ISLA (mixta)
Max InterAmericas Inc	544731	Pasta Veloce (mixta)
Max InterAmericas Inc	544354	MaxiRicco (mixta)
MEDA AB	544141	AURORIX
MEDA PHARMA GMBH & CO.KG	544144	KAMILLOSAN
MEDWELL OPERATIONS, INC.	543486	MEDWELL (mixta)
Melina González	543688	TRANZA (mixta)
MERAMA INC.	543568	MUVIN (mixta)
METAFAR S.A.	544482	farmaonline (mixta)
METAFAR S.A.	544479	Meta FARM@-on-line. (mixta)
Midea Group Co., Ltd.	544024	CertiTube (mixta)
MINERVA S.A.	544966	MINERVA FOODS (mixta)
Mistral International B.V.	543613	M (mixta)
Mistral International B.V.	543611	MISTRAL
MOINHO ARAPONGAS S/A	544961	JÓIA (mixta)
MOINHO ARAPONGAS S/A	544960	PÉROLA (mixta)
MOINHO ARAPONGAS S/A	544963	FLORIANI (mixta)
Moltok s.a.	543126	MTK (mixta)
MONASTERY COUTURE S.A.S.	543164	MST MONASTERY (mixta)
MONTAÑA STÜGELMAYER KELLY JUDITH	542833	MORINGA ORGÁNICA (mixta)
MORAGLIO ALONSO BRUNO RAUL	543258	BAHJA DELICIAS DEL MEDIO ORIENTE (mixta)
MOREIRA BESSO, GERARDO DANIEL	544414	LA CUADRA DEL PANADERO
ZUIN, DIEGO OSCAR y MOYA, GISELA	544642	NOI
MRO MaryRuth, LLC	544104	MARYRUTH'S
MRO MaryRuth, LLC	544106	(figurativa)
MSN Laboratories Private Limited	541887	DABIFIB
MTE - THOMSON INDÚSTRIA E COMÉRCIO LTDA.	544589	T MTE-THOMSON (mixta)
Musitar SA	543046	(figurativa)
NADIA CEDERBAUM LONDYNSKY	544352	DEPIMÉ
NADIR FIGUEIREDO S.A.	543815	OPALINE (mixta)
NADIR FIGUEIREDO S.A.	543811	SEMPRE (mixta)
NADIR FIGUEIREDO S.A.	543816	OPALINE
NADIR FIGUEIREDO S.A.	543803	DURALEX (mixta)
NADIR FIGUEIREDO S.A.	543801	COPO AMERICANO (mixta)
NADIR FIGUEIREDO S.A.	543804	MARINEX (mixta)
NADIR FIGUEIREDO S.A.	543809	N. (mixta)
NADIR FIGUEIREDO S.A.	543807	NADIR. (mixta)
NADIR FIGUEIREDO S.A.	543814	SEMPRE
NAMBI S.A.	544660	MONTAUK BRAVA BEACH
NATALE, SABRINA VERÓNICA	544276	PAPAISSON (mixta)
Natalia Castelo Cola	544125	Ropa para Jugar

Titular	N° Exp	Marca
Natalia Druziuk	543315	NEONE NEONE RED DE INSTITUTOS DE IDIOMAS Y CULTURA (mixta)
Natalia Jorcin	543683	MAMON (mixta)
Natalia Parodi	544728	MUNDOMOVIL (mixta)
National Basketball League Pty Ltd	544108	NBL OZ GAMING (mixta)
Naturel SAS	543024	NATUREL (mixta)
Nelly Isabel Maciel Dorado	543099	PANADERIA Y GALLETERIA LA INDUSTRIAL (mixta)
NELSON VICTOR SAULE FACHOLA	544770	GELATO DELIZIOSO HELADO ARTESANAL (mixta)
NESTOR JOSÉ PICCARDO REYES	544117	PICCARDO FAMILIA DE VINOS (mixta)
NÉSTOR JOSÉ PICCARDO REYES	544116	PICCARDO PARCELA UNO
NEUGEBAUER ALIMENTOS S.A.	543138	MU-MU KIDS (mixta)
NEUGEBAUER ALIMENTOS S.A.	543136	MU-MU (mixta)
NEW GATE TO PEACE FOUNDATION	543137	MAGDALA (mixta)
NGK SPARK PLUG CO., LTD.	544551	NITERRA (mixta)
Federico Alberto Storchi y Nicolás Mastronardi	543269	TUSSY
Nicolas Tribucio	543940	Stym IT (mixta)
NIKE INNOVATE CV una sociedad holandesa limitada (commanditaire vennootschap) organizada y existente bajo las leyes de Holanda	543760	NIKE MOTIVA
Nintendo of America Inc.	543953	KIRBY
NOGESA S.A.	544377	LOGAN FS (mixta)
North Bay Produce, Inc.	544878	NORTH BAY PRODUCE
North Bay Produce, Inc.	544881	NORTH BAY PRODUCE RÉSERVE
North Bay Produce, Inc.	544876	NORTH BAY PRODUCE (mixta)
North Sails Group, LLC	544710	NS (mixta)
North Sails Group, LLC	544713	NORTH SAILS (mixta)
Novartis AG	543802	(figurativa)
Nuritur S.A.	544138	PALITO BOMBON CELESTE
Nuritur S.A.	544272	Lekker (mixta)
NUTRIBIO	543463	NACTAMILK (mixta)
N.V. ORGANON	544857	XACIATO
ÑACUDI SRL	542877	FELIX CAFFÈ (mixta)
OCA S.A.	544437	OCA Comercios (mixta)
OCUMAR S.A.S.	543539	HIPPO COFFE BAR (mixta)
OFFSIDEUY S.A.S.	544388	OFFSIDE (mixta)
On Clouds GmbH	544604	On (mixta)
On Clouds GmbH	544150	CLOUDTEC
On Clouds GmbH	544148	CLOUD
ÖNTAR TARIM ALETLERI SANAYI VE TICARET LIMITED SIRKETI	543854	BUFER (mixta)
OPEN WORD SAS	542865	\$ OPEN WORD (mixta)
Oracle International Corporation	544522	ORACLE
ORIJUL SRL	544764	BIJOUAMANIA (mixta)
Orion Supply Chain Services S.A.S	544404	ORION SUPPLY CHAIN SERVICES (mixta)
Orveon Global Ltd.	543890	ORVEON
OSAN S.A.	542991	DELIBURG
OSAN S.A.	542989	MONTALVO
OSAN S.A.	542990	ABASTO SUR
Pablo Miguel Lopez Rafaniello	543079	MANSIORATI (mixta)
Pablo Miguel Lopez Rafaniello	543078	MANSIORATI (mixta)
Pablo Vanzini	544375	Selexion (mixta)

Titular	N° Exp	Marca
Pacific Investment Management Company LLC	543487	PIMCO PRIME REAL ESTATE
PACO RABANNE	544674	RABANNE
Panificadora Bimbo del Uruguay S.A.	543121	GRAN DULCE GALLETITAS DULCES (mixta)
Panificadora Bimbo del Uruguay S.A.	543120	GRAN DULCE GALLETITAS DULCES (mixta)
Panificadora Bimbo del Uruguay S.A.	543115	MERIENDA HIT (mixta)
Panificadora Bimbo del Uruguay S.A.	543118	MERIENDA HIT CERO (mixta)
Paola Francescoli	544417	Borneo
Paola Gonzalez	543266	GEKA GK.UY GESTION PROFESIONAL DE INMUEBLES (mixta)
Patricia sanchez machin	542424	DEPIL ARTE BY PATY SANCHEZ (mixta)
PAYPAL, INC.	544124	PP (mixta)
PAZEOM S.A.	544469	LAS MUSAS
PEGSA URUGUAY SA	544433	SEAN ETERNOS CAMPEONES DE AMERICA
Penny Alvarez	544568	Descubre Piriápolis Vintage Tour (mixta)
PEPSICO, INC.	544658	LEOGADO
PEPSICO, INC.	544894	Doritos DINAMITA Flamin' Hot (mixta)
PepsiCo, Inc	544657	LEOGACY
Perfule Cosméticos Ltda.	544880	Suaville (mixta)
PFIZER INC.	544737	(figurativa)
PFIZER INC.	544736	ELREXFIO
PFIZER IRELAND PHARMACEUTICALS	544392	VYDURA
PHARMADENT SAS	544494	PHARMA DENT (mixta)
Philip Morris Brands Sàrl	544569	PM PHILIP MORRIS INTERNATIONAL (mixta)
Philippe Rudloff	543681	MARCUARD LATAM (mixta)
PIBEIRO SOCIEDAD ANONIMA	543936	VDM (mixta)
PIETRO NOVO SOCIEDAD ANONIMA	542966	PIETRO NOVO
PIETRO NOVO SOCIEDAD ANONIMA	542963	NATURALFOAM (mixta)
PIETRO NOVO SOCIEDAD ANONIMA	542964	ADHO MUKHA (mixta)
PIETRO NOVO SOCIEDAD ANONIMA	542965	FEELING CLOC (mixta)
PLANTESIA FOREST ASSET MANAGEMENT S.A.S.	543981	EUCALYPTUS DEL SUR (mixta)
PLANTESIA FOREST ASSET MANAGEMENT S.A.S.	543977	EUCALYPTUS DEL SUR
PLANTIN SARL	543089	FERTI COLZA (mixta)
PPG INDUSTRIAL DO BRASIL - TINTAS E VERNIZES - LTDA.	543845	Centro de Pinturas (mixta)
Principia Biopharma Inc.	543452	GOLTRUBY
Principia Biopharma Inc.	543451	TOLRUPTIV
Professional Beauty Systems Limited	544398	CRAZY COLOR
PUNKTAL S.A.	544362	PUNKTAL ES PARA SIEMPRE
PUNTO LIMITE CAFE SRL	544837	PUNTO LIMITE CAFE GYM EST. 1991 (mixta)
Qatar Central Bank	544343	HIMYAN (mixta)
QUEEN'S SCHOOL S.R.L.	544184	QUEEN'S
QUINCY BIOSCIENCE, LLC	544766	PREVAGEN
RAMEZAL International S.A.	544237	CRC Cycling & Rowing Center (mixta)
RAPPA ANIDO, MARIO RAFAEL	543390	SIGNATURE WINEMAKER BM (mixta)
RAUCH Fruchtsäfte GmbH	544093	BRAVO
Rebeca Curbelo	543632	ANTONIA AROMAS TEXTILES
RECHAC THEVENET, MARIA NOEL	543311	OJOS DE LA VIUDA (mixta)

Titular	N° Exp	Marca
RED MARKET S.R.L.	543420	EL ALUVIÓN
RED VISUAL S.A.	544608	PLEXO (mixta)
REINA NEGRA SAS	543757	CHICOLITOS (mixta)
REINA NEGRA SAS	543755	REINA NEGRA (mixta)
REINOV SAS	542277	COLORFLEX
RIVERNOLD S.A.	543744	preschool (mixta)
RIVERNOLD S.A.	543746	El piso es lava
RIVERNOLD S.A.	543745	güden (mixta)
RIZOBACTER ARGENTINA S.A.	543471	ATERIX
RM GROUP SAS	543580	RMG AGRO
Roberto KECHICHIAN	543225	LA BAGUALA (mixta)
Roberto Osvaldo Perez y Roberto Pablo Perez	543260	EBIA (mixta)
Rodrigo Wilson Gayo Perez	543162	PUNTO CARNE ALMACEN DE CARNES (mixta)
RODRIGUEZ HNOS Y CIA LTDA	544539	R LA ESTANCIA VINO DE MESA TINTO SUAVE PUNTA YEGUAS URUGUAY FUNDADA EN 1937 (mixta)
RODRIGUEZ LAURENZO, DAHIANA JIMENA	543813	MI BAURU HOUSE (mixta)
ROLACOR S A	543759	GOLDTECH (mixta)
ROLACOR S A	543459	MARVO
Romina Diaz	544338	THE GARMENT BY ROMA (mixta)
Rosana Martínez	543416	EHOUSE BIENES RAÍCES WWW.EHOUSE.COM.UY (mixta)
ROSANO CHABAT NATALIA	543299	MULTI CLASES OTRA FORMA DE APRENDER (mixta)
ROSSI CASTILLO ROMINA STEFANY Y ROSSI CASTILLO NATALIA SOFIA SOCIEDAD DE HECHO	543310	COQUETT RESALTA TU BELLEZA (mixta)
Roxana Falero	543394	PRODUCTOS ARTESANALES SABORES DE LA SIERRA DESDE 1995 (mixta)
S. C. JOHNSON & SON, INC.	544676	TU AIRE. TU MOMENTO.
SABINA MARIA PEREZ VASQUEZ	544849	PHILO CAFE
SACHAJUAN Haircare AB	544765	SACHAJUAN
SALADFRESH S.R.L.	543208	NUESTRA QUINTA HIERBAS Y HORTALIZAS (mixta)
SALADFRESH S.R.L.	543496	SALADFRESH (mixta)
Salesforce, Inc.	543433	SALESFORCE
Salesforce, Inc.	543432	SALESFORCE (mixta)
Salesforce, Inc.	544140	SLACK
SALUNY SA	544350	CONCRETO
Salvagno Roselli, Juan Manuel	544579	RENACITI RESIDUOS RESPONSABLES (mixta)
Salvagno Roselli, Juan Manuel	544582	WORMBIN (mixta)
SAMI EL BADAQUI	544502	ILY
SAMI EL BADAQUI	544504	Cali
SAMI EL BADAQUI	544503	BYEM
SAMSUNG ELECTRONICS CO., LTD.	544925	SAMSUNG ECO-FRIENDS
SANDRA AVILA	544688	COSTUMBRES URUGUAYAS
SANMULY S.A.	544732	OKIDS (mixta)
SANTHER - FABRICA DE PAPEL SANTA THEREZINHA S.A.	543718	SYM (mixta)
Scavone Hnos. S.A.	544782	TRIAM
Scavone Hnos. S.A.	544785	EGASTAL
Scavone Hnos. S.A.	544793	MEMANTINA SCAVONE

Titular	N° Exp	Marca
Scavone Hnos. S.A.	544799	TELMISARTAN SCAVONE
Scavone Hnos. S.A.	544798	ROSUVASTATINA SCAVONE
Scavone Hnos. S.A.	544797	GABAPENTINA SCAVONE
Scavone Hnos. S.A.	544787	POLIGRAM
Scavone Hnos. S.A.	544789	ALGYOSAN
Scavone Hnos. S.A.	544791	DICLOFENAC SCAVONE
Scavone Hnos. S.A.	544792	PREGABALINA SCAVONE
Scavone Hnos. S.A.	544775	DIENCIL
Scavone Hnos. S.A.	544777	MIPEXOL
Scavone Hnos. S.A.	544780	LIPAREX
Scavone Hnos. S.A.	544784	VECAR
Scavone Hnos. S.A.	544788	CELEXIN
Scavone Hnos. S.A.	544801	SCAVONE
Scavone Hnos. S.A.	544795	METFORMINA SCAVONE
SCHLUMBERGER LIMITED (SCHLUMBERGER N.V.)	543902	SLB
SCHLUMBERGER LIMITED (SCHLUMBERGER N.V.)	543906	SLB (mixta)
SCHLUMBERGER LIMITED (SCHLUMBERGER N.V.)	543905	SLB (mixta)
SCHLUMBERGER LIMITED (SCHLUMBERGER N.V.)	543903	FOR A BALANCED PLANET
SCHOL PONS, ALEXIS	543847	TEMPLANZA
SEGURSA TEL S.A.	543373	JAGUAR SEGURIDAD & TECNOLOGÍA (mixta)
Servicios Humanos Integrales S.R.L.	544753	YOINERS (mixta)
Shanghai Lemon Tree Garment Co., Ltd.	543882	BBCAPLA (mixta)
Shanghai Lemon Tree Garment Co., Ltd.	543884	LEMON TREE (mixta)
SHARP KABUSHIKI KAISHA also trading as SHARP CORPORATION	544463	SHARP (mixta)
Shell Brands International AG	543092	SHELL EVOLUX (mixta)
SHENZHEN BORN PRETTY TECHNOLOGY CO.,LTD	544835	BORN PRETTY (mixta)
Shenzhen TCL New Technology Co., LTD.	543812	AIPQ
Shulton, Inc.	543772	OLD SPICE LEGACY
Sidela SA	545036	POXI-PREN
Sika Technology AG	541646	SIKASCREED
Sika Technology AG	541648	SIKALEVEL
Silvia tatiana Silva Martínez	544075	LA CASERITA PIZZABURGUER (mixta)
SIRENETTA S.A	543729	BERA BAY
SOCIEDAD COMERCIAL JJ SPA	544510	Japi Jane (mixta)
Société des Produits Nestlé S.A.	544725	NESTLÉ
SODEXO PASS INTERNATIONAL	544367	PLUXEE
SOFTYS S.A.	545018	LADYSOFT
Soledad Casas	544647	Pueblo Chico
SOLIS GARCIA, DIEGO MATHIAS	544028	SUM (mixta)
SOTO BARRETO, Santiago	544538	CABORTEADA (mixta)
SOUTH AMERICAN EXPRESS S.A.	543712	SOLARIS
Sovereign Brands, L.L.C.	544824	(figurativa)
Spectra Studios LLC	544749	SPECTRA
SPORTS AND HEALTH SOLUTIONS SPA	544177	ILUS (mixta)
STAGNARI MOISE, IRMA VIRGINIA	544360	DEL PEDREGAL
Starbucks Corporation	544376	OLEATO
STIER BIER INDUSTRIA E COMERCIO DE BEBIDAS LTDA	544677	STIER (mixta)

Titular	N° Exp	Marca
STOKELY-VAN CAMP, INC.	543378	GATORLYTE
STOKELY-VAN CAMP, INC.	543379	GATORLITE
STRATEGIC REINSURANCE CONSULTING SA	542947	STRATEGIC REINSURANCE CONSULTING
SUARIL S.A.	543044	BEMAR CARMELO HOTEL (mixta)
SUPER U SAS	544020	PRECIO UNO (mixta)
Supercell Oy	544879	CLASH
Swedish Match North Europe AB	544684	ZYN
SWISS PHARMA GROUP S.A.	543794	SWISS PHARMA
SYEMED S.R.L.	544631	MAVERICK
SZABO S.A.	543397	MERTHIOLATE
Szabo S.A.	543564	Snella
Szabo S.A.	543563	Pergalen NF
Szabo S.A.	543561	Mictasol Azul
Szabo S.A.	543401	COLTIX
Szabo S.A.	543399	ZENELIS
Szabo S.A.	544672	IbuMejoral (mixta)
Szabo S.A.	543559	NUTRILEVA
Taniamara Kozub	543108	HEMP TOWN
tatiana enciso	543567	conecta2
TCL Technology Group Corporation	544070	TCL MOVEAUDIO NXT
TCL Technology Group Corporation	544069	TCL MOVEAUDIO NEO
TCL Technology Group Corporation	544068	TCL MOVEAUDIO AIR
TCL Technology Group Corporation	544063	TCL MOVEAUDIO
Techmedical Uruguay S.A.	543085	PROFHILO R PRODUCT LINE (mixta)
TELCAREN S.A.	545042	WMW (mixta)
Telefónica, S.A.	544506	T (mixta)
Telefónica, S.A.	544644	M SERVICIOS ECOSMART CO2 S (mixta)
Telfar LLC Limited Liability Company of New York	544256	TELFAR
Telfar LLC Limited Liability Company of New York	544258	TC (mixta)
Telfar LLC Limited Liability Company of New York	544257	TC TELFAR EST. 2005, NYC (mixta)
Tensolite S.A.	543964	tensolite (mixta)
Tensolite S.A.	543965	(figurativa)
Tensolite S.A.	543966	TENSOLITE
TePe Munhygienprodukter AB	543346	TEPE
Tessa SpA	544854	TESSA (mixta)
THE ABSOLUT COMPANY AKTIEBOLAG	543419	ABSOLUT NIGHTS
THE BANK OF NOVA SCOTIA	543979	SCOTIAZERO (mixta)
THE BANK OF NOVA SCOTIA	543978	SCOTIAZERO
THE CHARGING COMPANY INC	543722	XC POWER (mixta)
THE COCA-COLA COMPANY	544521	F (mixta)
THE COCA-COLA COMPANY	544019	FANTA (mixta)
THE COCA-COLA COMPANY	545005	PROSPERA (mixta)
The New Ways B.V.	543949	G-ROLLZ
THE POLO/LAUREN COMPANY, L.P.	544744	POLO EARTH RALPH LAUREN ANTILLES VETIVER (mixta)
THE POLO/LAUREN COMPANY, L.P.	544745	POLO EARTH RALPH LAUREN MOROCCAN NEROLI (mixta)
THE POLO/LAUREN COMPANY, L.P.	544746	POLO EARTH RALPH LAUREN PROVENCIAL SAGE (mixta)
The Smiley Company SPRL	543620	(figurativa)
The Smiley Company SPRL	543616	(figurativa)

Titular	N° Exp	Marca
The Smiley Company SPRL	543609	(figurativa)
The Smiley Company SPRL	543612	(figurativa)
The Smiley Company SPRL	543607	(figurativa)
The Smiley Company SPRL	543608	(figurativa)
The Smiley Company SPRL	543617	(figurativa)
The Smiley Company SPRL	543619	(figurativa)
The Smiley Company SPRL	543615	(figurativa)
The Smiley Company SPRL	543601	(figurativa)
The Smiley Company SPRL	543603	(figurativa)
The Smiley Company SPRL	543605	(figurativa)
THECLINICPDE SAS	543837	Clínica del Mar (mixta)
TILVENOR S.A.	544295	FENIX SUPER 10
TK Elevator Innovation and Operations GmbH	543852	EOX
TOLEDO GRECCO HERNAN	544229	H. TOLEDO CONSTRUCCIONES (mixta)
Tomas Choroszczucha	543787	ESTANCIA CH TURISMO RESPONSABLE (mixta)
TONICOR S.A.	544017	LA CHACRA HOGAR
TONICOR S.A.	544016	LA CHACRA HOGAR
TOY CANTANDO SAS	543888	TOY CANTANDO (mixta)
TOY CANTANDO SAS	543887	TOY CANTANDO (mixta)
TOYOBO CO., LTD.	544474	TOYOBO MC
TOZOANI S.R.L	544015	KLAAS (mixta)
TRANSFLUVIAL NAVEGACION TFN S.A.	544632	T TRANSFLUVIAL (mixta)
TRANSPORTES JUANES SAS	544942	ARGOS ARGOS (mixta)
TURO INC.	543338	TURO
Uber Technologies, Inc.	544944	UBER ACUERDO
Uber Technologies, Inc.	544938	UBER TRAVEL
UCROPIT S.A.	544248	HISTORIA DEL CAMPO
UCROPIT S.A.	544247	FIELD STORY
UDITEX SA	543238	RIPMOBILITY (mixta)
Unigrà S.r.l.	544935	MASTER MARTINI (mixta)
Unigrà S.r.l.	544936	MARTINI PROFESSIONAL (mixta)
UNILAM S.A	543672	LUCCE (mixta)
UNILAM S.A	543671	LUCCE (mixta)
Universal Biosensors Pty Ltd	543476	XpreciaPrime (mixta)
Universal Biosensors Pty Ltd	543478	XPRECIA PRIME
URBIWEL S.A.	543333	SANTA ROSA VINO BLANCO (mixta)
URBIWEL S.A.	543334	SANTA ROSA VINO TINTO (mixta)
URBIWEL S.A.	543332	SANTA ROSA VINO ROSADO (mixta)
VALENCIA CITRUS SRL	542821	SANTÉ (mixta)
VALENCIA CITRUS SRL	544302	FLOW (mixta)
Vaxcyte, Inc.	543270	VAXCYTE
VAZQUEZ FREIJE, PABLO HERNÁN	543895	TENTACIONES SEX SHOP (mixta)
VENTURA RENTALS S.A.S.	544113	NÓRDICO (mixta)
VENTURA RENTALS SAS	544084	ALADIN (mixta)
VIACHESLAV MICHAELOVITCH ZAITSEV	543738	SLAVA ZAITSEV
VIDAL AGUADE, ESTEBAN OSCAR	542931	Q QUALITAS (mixta)
VIDIELLA OHOLEGUY, SOFIA	542934	REYES DESARROLLOS INMOBILIARIOS (mixta)
Villon International LLC	544819	(figurativa)
Villon International LLC	544821	(figurativa)
Villon International LLC	543991	VILLON
VINTES WINES, S.L	543843	AVIVA
Violet Fog International LLC	544823	(figurativa)

Titular	N° Exp	Marca
Violet Fog International LLC	543992	McQueen and the Violet Fog
VIRBAC S.A.	543597	CYCLAVANCE
Vista Cresta S.A.	544547	LUMICENTRO (mixta)
VITALECO S.R.L.	544508	VITALECO (mixta)
Vluncor SAS	544429	ANTERA GARDEN SUPPLIES (mixta)
VOLCANES DEL SUR S.A.	544089	VOLCANES DEL SUR
VON DUTCH COMPANY, S.A.	544623	FRENCHIE BONIE (mixta)
Wanbang Digital Energy Co., Ltd. y Wanbang Star Charge Technology Co., Ltd.	543800	STAR CHARGE (mixta)
WARMOL S.A.S.	543579	P PAULISTA. (mixta)
WECHARGE ELETROPOSTOS LTDA	543996	wecharge
WEISS BENQUET MONICA Y PEROVICH VALLARINO MONICA GRACIELA SOCIEDAD DE HECHO	543942	M 2M PRIMERA CONSULTORA EDUCATIVA INTEGRAL DEL URUGUAY (mixta)
Western Australian Agriculture Authority	543602	SOLUNA
Fabian Fernandez y Williams Gerardo Lacuesta Iriondo	543676	FERNÁNDEZ & SENCIÓN (mixta)
WIT S.A.	544695	MOPLEX (mixta)
WOODS & GO DESIGN, S.L.	543485	C CREATE (mixta)
WORLD BRANDING MARK S.A.	544198	M MANCERA (mixta)
WORLD BRANDING MARK S.A.	544197	MTL MONTALE (mixta)
XAVIER, CARLA MARIA y XAVIER, ALEXIS MARIA	543095	ROLL AND ROCK BEACH HOUSE (mixta)
Ximena Viera	543600	Xime Dulces Creaciones (mixta)
YANTAI DONGCHENG BIOCHEMICALS CO., LTD.	544708	DC PHARMA (mixta)
Ylor Corporation	543753	BABELITO
YUYE CAI	543849	IPARAH (mixta)
Zahart Ltda.	543263	GRAND TURKISH BAZAR (mixta)
Zahart Ltda.	543264	BEBECHIC (mixta)
ZALDIVAR, MARIA LAURA	543460	RIGGO UNIFORMES (mixta)
Zhejiang Qianjiang Motorcycle Co., Ltd.	543952	QJTEC (mixta)
ZHEJIANG USHAS COSMETICS CO., LTD.	544833	SAS (mixta)
ZODIAC INTERNATIONAL CORPORATION	543562	DEXIVANT (mixta)
ZODIAC INTERNATIONAL CORPORATION	544342	BUNATRIL
ZODIAC INTERNATIONAL CORPORATION	544341	ROFENAL
ZODIAC INTERNATIONAL CORPORATION	544344	PENTASIL
ZOGENIX, INC.	542820	AKTUZI
ZOGENIX, INC.	542920	KYGEVVI
1087 SAS	544090	Q QUIRAL (mixta)

ÍNDICE POR TITULARES DE FRASES PUBLICITARIAS

Titular	N° Exp	Marca
Sofia Maradei y Ana Victoria Miguel Olivera	544460	VENITE A UY OPORTUNIDADES PARA EXTRANJEROS QUE QUIERAN VENIR A URUGUAY BÚSQUEDAS IT (mixta)
BANCA DE CUBIERTA COLECTIVA DE QUINIELAS DE MONTEVIDEO	544883	Confía en tu instinto

Titular	N° Exp	Marca
Carlos Eduardo Ferreira Rodríguez	544846	Generando confianza
COLEGIO NUEVA CULTURA	543630	EDUCAR PARA LA VIDA
EFUSIÓN S.A.	543210	EFUSIÓN, VALORIZAMOS EL AGUA
FUCAC VERDE COOPERATIVA DE AHORRO Y CREDITO	543875	ELEGI VERDE
FUCAC VERDE COOPERATIVA DE AHORRO Y CREDITO	543876	LO PRIMERO QUE TE PRESTAMOS, ES ATENCIÓN
JOHNSON & JOHNSON	544041	HACEMOS REALIDAD EL PODER EXTRAORDINARIO DEL CUIDADO DIARIO
Panificadora Bimbo del Uruguay S.A.	543146	URUGUAY QUE NO NI NO!!
Panificadora Bimbo del Uruguay S.A.	543144	LA CABALA? UN RICARDITO
Penino Monje, Lizet Eliane	543774	EL PODER DE TU BELLEZA
PEPSICO, INC.	544698	SED DE MAS
S. C. JOHNSON & SON, INC.	544519	DECILE SI A TU MUNDO
Tensolite S.A.	543963	SIEMPRE UN PASO ADELANTE

ÍNDICE

Listado de Códigos Utilizados en el Boletín.....	7
Listado de Agentes de la Propiedad Industrial	11
Solicitudes de Marcas	25
Solicitudes de Frases Publicitarias	340
Resoluciones de Marcas, Concedidas.....	345
Resoluciones de Frases Publicitarias, Concedidas	447
Resoluciones de Frases Publicitarias, desestimadas	449
Resoluciones de Marcas, desestimadas	449
Resoluciones de Marcas, desestimadas (Art. 92, D. 34/999).....	454
Resoluciones de Renovaciones, desestimadas (Art. 92, D. 34/999)	454
Resoluciones de Marcas, desistidas (Art. 90, D. 34/999).....	455
Resoluciones de Marcas, desistidas (Art. 92, D. 34/999).....	455
Resoluciones de Frases Publicitarias, desistidas (Art. 92, D. 34/999)	457
Resoluciones de Renovaciones, desistidas (Art. 90, D. 34/999)	457
Resoluciones de Renovaciones, desistidas (Art. 92, D. 34/999)	458
Resoluciones de Marcas, Modificadas.....	458
Resoluciones de Marcas, Anuladas	459
Resoluciones de Renovaciones, Modificadas	460
Resoluciones de Renovaciones, Anuladas	461
Resoluciones de Renovaciones, Concedidas.....	461
Resoluciones de Renovaciones de Frases Publicitarias, Concedidas.....	533
Transferencias.....	533
Transferencias desestimadas (Art. 92, D. 34/999).....	554
Transferencias Parciales	554
Transferencias de Frases Publicitarias	555
Transferencias de Patentes	555
Cambios de Nombre	556
Cambios de Nombre desestimados (Art. 92, D. 34/999).....	569
Cambios de Nombre de Patentes.....	569
Cambios de Domicilio.....	570
Cambios de Domicilio de Frases Publicitarias	591
Cambios de Domicilio desistidos (Art. 92, D. 34/999)	591
Cambios de Domicilio de Patentes.....	592
Inscripciones de Licencias.....	592
Inscripciones de Licencias, desestimadas (Art. 92, D. 34/999)	592
Inscripciones de Sublicencias.....	593
Inscripciones de Prendas.....	593
Inscripciones de Renuncias Totales.....	593
Inscripciones de Renuncias Parciales.....	594
Resoluciones de Recursos, DNPI	595
Resoluciones de Recursos de Renovaciones, DNPI	596
Resoluciones de Reivindicaciones	596
Resoluciones de Patentes, Concedidas	596

Resoluciones de Diseños Industriales, Concedidas	600
Resoluciones de Patentes, desestimadas	600
Resoluciones de Diseños Industriales, desestimadas	604
Resoluciones de Patentes, desistidas.....	604
Resoluciones de Patentes, Abandonadas.....	604
Notificaciones de Asesoría	616
Notificaciones de Recurso.....	622
Solicitudes de Patentes de Invención.....	627
Solicitudes de Diseños Industriales.....	673
Solicitudes de Modelos de Utilidad.....	679
Índice por Titulares de Marcas.....	683
Índice por Titulares de Frases Publicitarias.....	703
Índice.....	705

Depósito legal 325.532
(N° 278)
Impreso en D.N.P.I.
E-mail: administracion.dnpi@miem.gub.uy
Rincón 719 Telefax 2840 1234
C.P. 11.000
Montevideo – Uruguay

Montevideo, 30 de noviembre.2022

Noviembre 2022