

Boletín de la Propiedad Industrial

Nº 307

República Oriental del Uruguay

Ministerio de Industria, Energía y Minería
Dirección Nacional de la Propiedad Industrial

15/04/2024



Ministerio
**de Industria,
Energía y Minería**

Dirección Nacional
de la Propiedad Industrial

República Oriental del Uruguay



Ministerio
**de Industria,
Energía y Minería**

*Dirección Nacional de la
Propiedad Industrial*

BOLETÍN
DE LA PROPIEDAD
INDUSTRIAL

ISSN 2301 – 1777
Impreso en D.N.P.I.
Permiso N° 2160 (Biblioteca Nacional)
URUGUAY

REPÚBLICA ORIENTAL DEL URUGUAY



MINISTERIO DE INDUSTRIA, ENERGÍA Y MINERÍA
DIRECCIÓN NACIONAL DE LA PROPIEDAD INDUSTRIAL

ING. MAG. ELISA FACIO
MINISTRO DE INDUSTRIA, ENERGÍA Y MINERÍA

SR. WALTER VERRI
SUBSECRETARIO
MINISTERIO DE INDUSTRIA, ENERGÍA Y MINERÍA

DRA. NATALIA JUL
DIRECTORA GENERAL DE SECRETARÍA
MINISTERIO DE INDUSTRIA, ENERGÍA Y MINERÍA

DR. MAG. SANTIAGO MARTÍNEZ MORALES
DIRECTOR TÉCNICO DE LA PROPIEDAD INDUSTRIAL
MINISTERIO DE INDUSTRIA, ENERGÍA Y MINERÍA

de acuerdo a lo establecido por los artículos 80 y 101 de la Ley
N° 17.011 de fecha 25 de Setiembre de 1998 ésta es la
Publicación Oficial de la Dirección Nacional de la Propiedad
Industrial, Unidad Ejecutora del Ministerio de Industria, Energía
y Minería, cuyo cometido sustantivo es administrar y proteger el
derecho de la Propiedad Industrial.

RINCON 719 – Teléfono 2900 0658 – C.P. 11.000

e-mail: secretaria.dnpi@miem.gub.uy

<http://www.miem.gub.uy>

LISTADO DE CÓDIGOS UTILIZADOS EN EL BOLETÍN

LISTA DE CÓDIGOS, POR ORDEN ALFABÉTICO, Y LOS NOMBRES CORRESPONDIENTES (ABREVIADOS) DE ESTADOS, OTRAS ENTIDADES Y ORGANIZACIONES INTERGUBERNAMENTALES.

AD	ANDORRA	CV	CABO VERDE
AE	EMIRATOS ARABES UNIDOS	CY	CHIPRE
AF	AFGANISTAN	CZ	REPUBLICA CHECA
AG	ANTIGUA Y BARBUDA		
AI	ANGUILLA	DE	ALEMANIA
AL	ALBANIA	DJ	DJIBOUTI
AM	ARMENIA	DK	DINAMARCA
AN	ANTILLAS NEERLANDESAS	DM	DOMINICA
AO	ANGOLA	DO	REPUBLICA DOMINICANA
AP	ORGANIZACIÓN REGIONAL AFRICANA DE LA PROPIEDAD INDUSTRIAL (ARIPO)	DZ	ARGELIA
AR	ARGENTINA	EA	ORGANIZACIÓN EUROASIÁTICA DE PATENTES (EAPO)
AT	AUSTRIA	EC	ECUADOR
AU	AUSTRALIA	EE	ESTONIA
AW	ARUBA	EG	EGIPTO
AZ	AZERBAIYAN	EH	SAHARA OCCIDENTAL
		EM	OFICINA PARA LA ARMONIZACIÓN DEL MERCADO INTERIOR (MARCAS Y DIBUJOS Y MODELOS) (OAMI)
BA	BOSNIA Y HERZEGOVINA	EP	OFICINA EUROPEA DE PATENTES (OEP)
BB	BARBADOS	ER	ERITREA
BD	BANGLADESH	ES	ESPAÑA
BE	BELGICA	ET	ETIOPIA
BF	BURKINA FASO		
BG	BULGARIA	FI	FINLANDIA
BH	BAHREIN	FJ	FIJI
BI	BURUNDI	FK	ISLAS FALKLAND (MALVINAS)
BJ	BENIN	FO	ISLAS FEROE
BM	BERMUDA	FR	FRANCIA
BN	BRUNEI DARUSSALAM		
BO	BOLIVIA	GA	GABON
BR	BRASIL	GB	REINO UNIDO
BS	BAHAMAS	GC	OFICINA DE PATENTES DEL CONSEJO DE COOPERACION DE LOS ESTADOS ARABES DEL GOLFO (CCG)
BT	BHUTAN	GD	GRANADA
BV	ISLA BOUVET	GE	GEORGIA
BW	BOTSWANA	GH	GHANA
BX	OFICINA BENELUX DE MARCAS (BBM) Y OFICINA BENELUX DE DIBUJOS Y MODELOS (BBDM)	GI	GIBRALTAR
BY	BELARUS	GL	GROENLANDIA
BZ	BELICE	GM	GAMBIA
		GN	GUINEA
CA	CANADA	GQ	GUINEA ECUATORIAL
CD	REPUBLICA DEMOCRATICA DEL CONGO	GR	GRECIA
CF	REPUBLICA CENTROAFRICANA	GS	ISLAS GEORGIA DEL SUR Y SANDWICH DEL SUR
CG	CONGO	GT	GUATEMALA
CH	SUIZA	GW	GUINEA - BISSAU
CI	COTE D'IVOIRE	GY	GUYANA
CK	ISLAS COOK	HK	REGION ADMINISTRATIVA ESPECIAL DE HONG KONG DE LA REPUBLICA POPULAR DE CHINA
CL	CHILE		
CM	CAMERUN	HN	HONDURAS
CN	CHINA	HR	CROACIA
CO	COLOMBIA	HT	HAITI
CR	COSTA RICA	HU	HUNGRIA
CS	SERBIA Y MONTENEGRO		
CU	CUBA		

IB	OFICINA INTERNACIONAL DE LA ORGANIZACIÓN MUNDIAL DE LA PROPIEDAD INTELECTUAL (OMPI)	NG	NIGERIA
ID	INDONESIA	NI	NICARAGUA
IE	IRLANDA	NL	PAISES BAJOS
IM	ISLA DE MAN	NO	NORUEGA
IL	ISRAEL	NP	NEPAL
IN	INDIA	NR	NAURU
IQ	IRAQ	NZ	NUEVA ZELANDIA
IR	IRAN(REPUBLICA ISLAMICA DEL)	OA	ORGANIZACION AFRICANA DE LA PROPIEDAD INTELECTUAL (OAPI)
IS	ISLANDIA	OM	OMAN
IT	ITALIA	PA	PANAMA
JM	JAMAICA	PE	PERU
JO	JORDANIA	PG	PAPUA NUEVA GUINEA
JP	JAPON	PH	FILIPINAS
KE	KENYA	PK	PAKISTAN
KG	KIRGUISTAN	PL	POLONIA
KH	CAMBOYA	PT	PORTUGAL
KI	KIRIBATI	PW	PALAU
KM	COMORAS	PY	PARAGUAY
KN	SAINT KITTS Y NEVIS	QA	QATAR
KP	REPUBLICA POPULAR DEMOCRATICA DE COREA	RO	RUMANIA
KR	REPUBLICA DE COREA	RS	SERBIA
KW	KUWAIT	RU	FEDERACION DE RUSIA
KY	ISLAS CAIMAN	RW	RWANDA
KZ	KAZAKSTAN	SA	ARABIA SAUDITA
LA	REPUBLICA DEMOCRATICA POPULAR LAO	SB	ISLAS SALOMON
LB	LIBANO	SC	SEYCHELLES
LC	SANTA LUCIA	SD	SUDAN
LI	LIECHTENSTEIN	SE	SUECIA
LK	SRI LANKA	SG	SINGAPUR
LR	LIBERIA	SH	SANTA HELENA
LS	LESOTHO	SI	ESLOVENIA
LT	LITUANIA	SK	ESLOVAQUIA
LU	LUXEMBURGO	SL	SIERRA LEONA
LV	LETONIA	SM	SAN MARINO
LY	JAMAHIRIYA ARABE LIBIA	SN	SENEGAL
MA	MARRUECOS	SO	SOMALIA
MC	MONACO	SR	SURINAME
MD	REPUBLICA DE MOLDOVA	ST	SANTO TOME Y PRINCIPE
ME	MONTENEGRO	SV	EL SALVADOR
MG	MADAGASCAR	SY	REPUBLICA ARABE SIRIA
MK	EX REPUBLICA YUGOSLAVA DE MACEDONIA	SZ	SWAZILANDIA
ML	MALI	TC	ISLAS TURCOS Y CAICOS
MM	MYANMAR	TD	CHAD
MN	MONGOLIA	TG	TOGO
MO	MACAO	TH	TAILANDIA
MP	ISLAS MARIANAS SEPTENTRIONALES	TJ	TAYIKISTAN
MR	MAURITANIA	TM	TURKMENISTAN
MS	MONTserrat	TN	TUNEZ
MT	MALTA	TO	TONGA
MU	MAURICIO	TP	TIMOR ORIENTAL
MV	MALDIVAS	TR	TURQUIA
MW	MALAWI	TT	TRINIDAD Y TOBAGO
MX	MEXICO	TV	TUVALU
MY	MALASIA	TW	TAIWAN, PROVINCIA DE CHINA
MZ	MOZAMBIQUE	TZ	REPUBLICA UNIDA DE TANZANIA
NA	NAMIBIA	UA	UCRANIA
NE	NIGER		

UG	UGANDA	WO	ORGANIZACIÓN MUNDIAL DE LA PROPIEDAD INTELLECTUAL (OMPI) (OFICINA INTERNACIONAL DE)
US	ESTADOS UNIDOS DE AMERICA	WS	SAMOA
UY	URUGUAY		
UZ	UZBEKISTAN	YE	YEMEN
VA	SANTA SEDE	ZA	SUDAFRICA
VC	SAN VICENTE Y LAS GRANADINAS	ZM	ZAMBIA
VE	VENEZUELA	ZW	ZIMBABWE
VG	ISLAS VIRGENES (BRITANICAS)		
VN	VIET NAM		
VU	VANUATU		

MARCAS (Norma OMPI St. 60)

(210) – Número de Solicitud.

(730) – Nombre y dirección del solicitante o titular del Registro.

(220) – Fecha de presentación de la solicitud.

(511) – Clase y/o Producto o Servicio protegido (Clasificación de Niza) (Novena Edición).

(540) – Reproducción de la Marca.

(300) – Datos relativos a la prioridad en virtud del Convenio de la Unión de París (Número asignado a la primera solicitud, fecha de presentación de la primera solicitud, código de la Norma Ompi St 3 de la Oficina nacional o regional donde se presentó la primera solicitud).

(591) – Información relativa a los colores reivindicados.

(551) – Indicación de que la marca es una marca colectiva o una marca de certificación o garantía.

(554) – Marca tridimensional.

(556) – Marca sonora, incluidas las características.

(740) - Datos del Agente de la Propiedad Industrial.

PATENTES Y MODELOS DE UTILIDAD (Norma OMPI St. 9)

- (21) - Número de la solicitud de Invención o Modelo de Utilidad.
- (22) - Fecha de presentación de la solicitud.
- (12) - Designación del tipo de documento.
- (71) - Datos del solicitante, incluyendo nombre y país de origen.
- (72) - Nombre del Inventor/es.
- (51) - Clasificación Internacional de Patentes (Clasificación de Estrasburgo) (Sexta Edición).
- (54) - Título de la Invención.
- (57) - Resumen y diseño de la invención o descripción del modelo de utilidad o diseño (no más de 100 palabras).
- (74) - Nombre del Agente de la Propiedad Industrial.
- (30) - Datos relativos a la prioridad en virtud del Convenio de la Unión de París.
- (31) - Número asignado a la solicitud prioritaria o reválida.
- (32) - Fecha de depósito de la solicitud prioritaria.
- (33) - Código de la Norma St. 3 de Ompi que identifica a la Oficina de Propiedad Industrial que ha atribuido el número a la solicitud prioritaria o de la Organización que ha atribuido el número de la solicitud regional prioritaria (para las solicitudes internacionales registradas en virtud del PCT, debe utilizarse el Código "WO").

A continuación del número de la solicitud correspondiente (Código 21), deberá aplicarse el código normalizado para la identificación de los diferentes tipos de documentos de patentes (Norma Ompi St. 16):

A1: Invención Primaria

U: Modelo de Utilidad

DISEÑOS Y MODELOS INDUSTRIALES (Norma OMPI St. 80)

- (21) - Número de la solicitud del diseño o modelo industrial.
- (22) - Fecha de presentación de la solicitud.
- (12) - Designación del tipo de documento.
- (71) - Datos del solicitante, incluyendo nombre y país de origen.
- (72) - Nombre del creador/es.
- (51) - Clasificación Internacional para los Dibujos y Modelos Industriales (Clasificación de Locarno) (Sexta Edición).
- (54) - Título del Diseño o Modelo.
- (57) - Resumen y descripción del diseño o modelo industrial incluidas las indicaciones de colores (no más de 100 palabras).
- (74) - Nombre del Agente de la Propiedad Industrial.
- (30) - Datos relativos a la prioridad en virtud del Convenio de la Unión de París.
- (31) - Número asignado a la solicitud prioritaria o reválida.
- (32) - Fecha de depósito de la solicitud prioritaria.
- (33) - Código de la Norma St. 3 de Ompi identificando a la Oficina nacional o regional u organización en la que se presentó la solicitud prioritaria (para los depósitos internacionales presentados en virtud del Arreglo de La Haya, se debe utilizar el Código "WO"). A continuación del número de la solicitud correspondiente (Código 21) deberá aplicarse el código normalizado para la identificación de los diferentes tipos de documentos (Norma OMPI St. 17):

Q: Diseños y Modelos Industriales

LISTADO DE AGENTES DE LA PROPIEDAD INDUSTRIAL

Nro	Nombre	Dirección	CP	Teléfono	Fax	E-mail
3	CIKATO LAY, MANFREDO ANDRES	Araucana 1277	11400	2606.06.06	2606.14.39	cikato@cikato.com.uy
6	MARINARI SEXTO, WALTER HUGO	25 de Mayo 576	11000	2916.34.55	2916.21.93	bacot@bacot.com.uy
8	ARROLI TELESCA, RUBEN JOSE	Ituzaingó 1485 esc.12	11000	2915.94.75		
12	FREIRA SERRAT, CARLOS MARIA	Río Negro 1394 piso 10 esc.10	11100	2901.16.70/ 2901.58.32		
15	DAIQUI BALMACEDA, JUAN CARLOS	Río Negro 1394 piso 10 esc.10	11100			
16	GIMENEZ SORHUET, ROBERTO DARIO	Florida 1485 ap.301	11000	2901.22.78		
17	PONCE DE LEON MURO, JULIO CESAR	Florida 1485 ap.301	11000	2901.22.78		
18	BACOT SILVEIRA, OSCAR TULIO	25 de Mayo 576	11000	2916.34.69	2916.21.93	obacot@bacot.com.uy
19	FREIRA SERRAT, JUAN MIGUEL	Plaza Cagancha 1335 esc. 317/18	11100	2900.06.86	2908.71.27	jmfreira@adinet.com.uy
20	FOX TAYLOR, NORMAN ALEXANDER	Pedro Murillo 6136	11500	2604.03.60	2604.66.69	nfox@fox.com.uy
21	LAMAS BALESTRA, MARIO DANIEL	Lucerna 6273	11400	2600.37.67		dlamas@lamasgrimaldi.com.uy
23	BONADA ASUAGA, ROBERTO GUZMAN	Lancasteriana 2359 bis	11400	2600.72.24		
24	LANZON MAZZELLO, RAFAEL EDUARDO	Brandzen 1961 esc.102	11200	2408.50.38	2409.97.61	rlanzon@lanzon.com.uy
25	PIÑEYRO CAMACHO, MARTHA NELIDA	Plaza Independencia 848 1er. Piso	11000	2908.81.36		mpineyro@montevideo.com.uy
26	VECINO SANCHEZ, GERMAN	Mones Roses 6937	11500	2604.16.04	2604.66.04	gvecino@ppv.com.uy
28	MEDINA YLLA, EDUARDO JOSE	Av. Garibaldi 2185		2203.93.06/ 2209.51.40	2200.74.74	info@medinamarcas.com
29	PITTALUGA SHAW, JUAN ANTONIO	Echevarriarza 3535 Of. 1601 Torre A	11300	2623.29.59	2623.29.57	juan@pittaluga.com
30	MAESO VALINO, MARIA CRISTINA	Colonia 1825 apto.402				
31	PILAS SEMICHEVICH, RODOLFO	Av. Uruguay 2049 bis	11100	2409.36.02	2401.55.72	uruguay@pilasnet.com.uy
32	MELGAR PEREZ, ASTUR EULOGIO	Av. Uruguay 1826	11100	2409.17.00	2402.30.55	

Nro	Nombre	Dirección	CP	Teléfono	Fax	E-mail
34	FERNANDEZ SECCO, GONZALO JOSE	25 de Mayo 467 piso 5	11000	2916.19.13	2916.57.40	gonzalo@fernandezsecco.com.uy
35	D' ALESSANDRO VALIDO, JULIO CESAR	Juan Paullier 2015	11200	2400.39.70		
37	FERNANDEZ PEREZ, EDUARDO LUIS	Fernández Crespo 1861 bis	11200	2400.22.90	2400.22.90	eduardoluisf@gmail.com
38	BOGNANNO PAULOS, NOEMI CLARA	Rincón 682 esc.14	11000	2916.38.72		
39	CROCCO MARTINEZ, ALVARO HARRIET	Av. Garibaldi 2276		2200.74.24		
40	MORGADE DI POLITO, CLAUDIO	Av. de las Américas 8336, Block 1, Ap.101	15000	094.429.107		cmorgade@morgade.uy
41	DELPIAZZO RODRIGUEZ, CARLOS ENRIQUE	Misiones 1424 piso 5	11000	2915.30.30	2915.30.30 int. 512	delpiazzo@delpiazzo.com.uy
42	ARGENTINO DE BELLO, ROSARIO NELLY	Juncal 1431 esc. 402	11000	-		
43	AURUCCI DE MORALES, SYLVIA RITA	25 de Mayo 395 piso 3 apto.6	11000	-		
44	SAAVEDRA LEVRATTO, LORENZO	Zapicán 2980-82		2209.46.83		
45	DOCAMPO EIRIN, ALBERTO MARIO	Rivera 6056		2600.39.41		
46	EIRIN DI FAZIO, ALVARO JORGE	Plaza Independencia 831 esc. 609	11300	2902.75.49	2902.35.51	
47	PISANI PALMER, CARLOS ORLANDO	R. Hayadelat 1688		2619.63.77		
48	MONTANO GOMEZ, PEDRO JULIO	Plaza Cagancha 1335 ap. 1104	11100	2903.07.80	2903.07.80 int. 211	sym@scelzaymontano.com.uy
49	ORDOQUI CASTILLA, GUSTAVO ANTONIO	Rincón 728	11000	2708.38.03		gustavo@ordoquicastilla.com
50	CORTI ACOSTA, GRACIELA BEATRIZ	Obligado 1070	11300	2709.30.95		gcorti@adinet.com.uy
51	SCELZA MARTINEZ, FERNANDO LUIS	Rba. Rep. del Perú 1043	11300	2708.29.50		
52	PRAT GUTIERREZ, AGUSTIN JULIO	Palacio Lapidó Av. 18 de julio 948 ap.401	11100	29047739		pratasoc@usa.net
53	APEZECHEA SANTINI, JOSE ANTONIO	Colonia 2108 apto.701	11200	2408.43.08		
54	NAVARRO CASTEX, ALEJANDRO MARIANO	Pza. Independencia 1374	11100	2902.42.16		

Nro	Nombre	Dirección	CP	Teléfono	Fax	E-mail
55	RODRIGUEZ TURRINA, LUIS ALBERTO	Río Negro 1380	11100	2908.50.62		
56	CAGNOLA MERCADAL, CARLOS	La Paz 1988		2400.56.95		
57	IRIGOYEN DESCALZI, JOSE MARTÍN	25 de Mayo 635 esc. 203	11000	2916.03.37		
58	SANJINES RAVIZZA, CRISTOBAL ERNESTO	Duvimioso Terra 2327 apto. 6	11200	-		
59	MUSSIO TORRES, DIEGO EDUARDO	J.M.Blanes 869	11200	2413.65.67		
61	BALLIVA GIMENEZ, WASHINGTON ULISES	Rincón 540 piso 7	11000	-		
62	ZARUCKI ABRAMODICAS, JAIME	Bulevar Artigas 515 apto. 301	11300	-		
63	POPLAWSKI NATANSON, LIZABETH	Maldonado 2422 apto. 21	11200	-		
64	GAMUNDI DEMARCO, GERARDO ANIBAL	José Benito Lamas 2792	11300	-		
65	MARTINEZ LEONI, JOSE LUIS	Brandzen 1961 esc.602	11200	2407.81.72	2407.81.75	jose@martinezleoni.com.uy
66	DE POSADAS MONTERO, DIEGO ANTONIO	Rincón 454 esc. 316	11000	-		
67	MAYER MARTINEZ, FEDERICO OSCAR	Ituzaingó 1393 esc. 503	11000	-		
68	MOREIRA PIEGAS, ROBERTO	Colonia 981 esc. 604	11100	2900.34.71	2900.86.22	moreirap@adinet.com.uy
69	FONT BERTINAT, BISMARCK ENRIQUE	Av. Uruguay 872	11100	2902.55.65/ 2902.55.67		
70	ZAS FERNANDEZ, JORGE	Ejido 1425 esc. 3	11100	-		
71	LAURNAGA MARANA, VICTORIO JORGE	Bulevar España 2575 apto. 302	11300	-		
72	COSTA ALBERTONI, NEDER ERNESTO	25 de mayo 477 esc. 28	11000	-		
74	LAMAS MORENO, LUIS FLORENCIO	Ramón Massini 3304 apto. 403	11300	2708.47.61		
75	CHIARINO MAÑE, ARMANDO	García de Zúñiga 2265	11300	2711.07.77		
76	SUAREZ ANTOLA, GRISELDA	18 de Julio 1805		2409.26.80		
77	STRAPETTI MONTESANO, HUGO	Av. Agraciada 2955 apto.106		-		

Nro	Nombre	Dirección	CP	Teléfono	Fax	E-mail
78	FERNANDEZ GOYECHEA, LUIS ENRIQUE	25 de Mayo 467 piso 4 esc. 7	11000	-		
79	MACIEL PAPPÀ, GUILLERMO HORACIO	Santiago Vázquez 1244 of. 502	11300	2916.34.55		
80	STEFANOLI PESCIETTO, ALEJANDRO	Juan Benito Blanco 1127 apto. 101	11300	2709.04.45		
81	FLORES CASTRO, GALA DEL CARMEN	Bulevar Artigas 3942 apto. 1		-		
82	HERVI BARROS, CARLOS ROGELIO	Dalmiro Costa 4486 apto. 2	11400	2619.55.94		
83	D' ALBORA SOLARI, FELIPE CONRADO	Dr. Francisco Soca 1360	11300	2708.11.20		
84	STEFANOLI PESCIETTO, MARIO FIDEL	Andes 1111	11100	2908.59.38		
85	FIGUEREDO MARTINEZ, OSCAR MARIO	25 de Mayo 477 esc. 50	11000	-		
86	INVIDIO MAURIELLO, SANTIAGO RODOLFO	25 de Mayo 661 esc. 205	11000	-		
87	ORLANDO SANTA MARIA, MARIA LORELEY	Juan Paullier 2416	11200	-		
89	FERRAZ MADRID, JOSE PEDRO	Juncal 1408 piso 5 esc. 9	11000	-		
90	ENRIQUEZ FIGOLI, JORGE RUBEN	Misiones 1371 piso 1 esc. 8	11000	-		
92	MENDEZ MANOVSKY, RUPERTO ALVARO	Tacuarembó 1442	11200	2402.90.96		
93	CANTON POMBO, MARCELO	Treinta y Tres 1420 piso 2 esc.15	11000	2916.52.25		
94	FISCHER FLEURQUIN, GUSTAVO RODOLFO	San José 807 Of. 403	11100	2908.71.67	2908.35.58	fischer@fischer.com.uy
95	VIANA FERREIRA, ENRIQUE ALIPIO	Av. Uruguay 1824 apto. 202	11200	-		
96	MONTORO HEGUERTE, FRANCISCO EDISON	Treinta y Tres 1374 esc.108	11000	2915.94.27		
97	FINALI PILAS, MIRYAM ROSSANA	Av. Uruguay 2049	11100	2409.36.02	2401.55.72	uruguay@pilasnet.com.uy
98	VILLAGRAN MERA, CLAUDIA	Juncal 1398 piso 4 esc.4/40	11000	-		
99	HENDLER TRIADOR, GABRIELA	Juncal 1395 esc.42	11000	-		

Nro	Nombre	Dirección	CP	Teléfono	Fax	E-mail
101	MARTINONI OTORMIN, GUSTAVO EDUARDO	Av. Brasil 2986 Of. 409, Torre Parque Sabato	11300	2707.75.18	2707.56.46	gustavomartinoni@martinoniyrodriguez.com
103	ABENTE LE BAS, DIEGO MONTGOMERY	Araucana 1277	11400	2606.06.06	2606.14.39	cikato@cikato.com.uy
104	PILAS PEREIRA, RODOLFO	Av. Uruguay 2049	11100	2409.36.02	2401.55.72	uruguay@pilas.com.uy
105	GERONA COSIO, HECTOR RICARDO	Colonia 815 esc. 504	11100	2901.36.08	2901.36.08	
106	GAMIO CIA, JUAN ENRIQUE	Misiones 1379 esc. 601	11000	-		
107	GUTIERREZ CARRAU, JUAN MANUEL	Rincón 528 Piso 6	11000	2916.50.94/ 2916.50.95	2916.13.59	
108	SILVA LEDESMA TERRA, JULIO CESAR	Rincón y 25 de Mayo, Ed.Rafael apto. 902, Maldonado				
109	PLA REGULES, MARIA MARTA	Cerrito 420 esc. 404	11000	2915.66.20		
110	AMOZA ANTUNEZ DE OLIVERA, EDGARDO	Juncal 1305 piso 2 esc. 206	11000	2916.43.66		
111	MINICELLI D'AMATO, NELSON DANIEL	Alfredo Baldomir 2363 apto.202	11300	-		
112	GUTIERREZ GALIANA, JORGE	Río Branco 1359 apto.903	11000	2901.78.34		
113	MOREIRA BIRRIEL, MARIA GRACIELA	Río Branco 1359 apto.903	11100	2901.78.34		
114	GENTA FONS, PABLO	Cnel. Brandzen 1961 of. 1004	11200	2409.24.21/ 2402.79.39	2408.77.26	gentafons@fastlink.com.uy
115	CARNELLI DI LEONE, CARLOS RAFAEL	Coronel Alegre 1321 piso 4	11300	2709.94.29		
116	IRIBARNE AGUINSKY, NORA	Bulevar España 2166 apto.302	11300	-		
117	GARCIA VILA, MARIO DANIEL	Maggiolo 685	11300	2711.57.41		
118	MARTINEZ VIVAS, MARIA INES	Costa Rica 1720 of.001	11000	2917.01.87	2916.34.05	minesm@adinet.com.uy
119	GIAMBRUNO MAROÑO, MARIA INES	25 de Mayo 467 piso 5	11000	2916.19.13	2916.57.40	mgiambruno@fernandezsecco.com
120	PONZONI GARCIA, JOSE LUIS	Juncal 1431 esc.702	11000	2915.82.11		

Nro	Nombre	Dirección	CP	Teléfono	Fax	E-mail
121	GUADALUPE BRENNIA, DIEGO	Ellauri 896 apto.101	11300	-		
122	VENCE CASSINA, TERESITA ANDREA	Hernandarias 3623	11400	2507.77.64		
123	CASTELLS BARTHABURU, MARÍA DE LAS MERCEDES	San José 807 esc. 403	11100	2908.71.67	2908.35.58	fischer@fischer.com.uy
124	CHARLONE SPINNELLI, BENJAMIN DANIEL	Brandzen 1961 esc.502	11200	-		
125	IGLESIAS HERRERO, LUIS FERNANDO	Zabala 1394 bis piso 1	11000			luisf.iglesias@gmail.com
126	ARIAS DURAN, JORGE ALFREDO	Ituzaingó 1312 apto.205	11000	2915.91.41/ 2915.89.08	2916.42.56	ariasjalf@yahoo.com
127	STIGLITZ HOLZMAN, BERNARDO MENDEL	18 de julio 1516 apto.2		-		
128	DURAN RAMALLO, JORGE HORACIO	San José 871	11100	-		
129	STEZANO MARIÑO, ANA MARIA	Convención 1307 Of.502	11100	2902.21.98	2902. 66.53/ 095314299	anamaria@stezano.com
130	GUICHON SILVA, JOSE LUIS	Pza.Cagancha 1335 esc. 206	11100	2902.31.18/ 2902.16.55	2902.13.44	jones@jones.com.uy
131	STUCZYNSKI SLONIMSKY, GERARDO DAVID	Charrúa 2665		-		
132	ESPALTER MASOLLER, HAROLDO JOSE	Dr. Elazarola 2319	11400	2600.02.07		
133	HUGHES PORRAS, MARIA MARIELA	25 de mayo 455 piso 4	11000	2915.56.83		
134	RISSO SHIEN, LAURA LUCIA	Río Negro 1354 apto.14	11100			
135	BACOT SILVEIRA, MONICA SUSANA	Av. 18 de Julio 841, piso 4 / 402		2903.20.47/ 2900.41.02	2903.21.03	monicabacot@mbs.com.uy
136	DEL CERRO ROLDOS, SUSANA VERÓNICA	Echevarriarza 3535 Of. 1601 Torre A	11300	2623.29.59	2623.29.57	sdelcerro@pittaluga.com
138	RODRIGUEZ VILLAMIL RIVIERE, RAMIRO	Máximo Tajes 6482	11400	2600.59.81		
140	LAPENNE IMAZ, EDUARDO MARCELO	Pedro Murillo 6136	11500	2604.03.60	2604.66.69	fox@fox.com.uy

Nro	Nombre	Dirección	CP	Teléfono	Fax	E-mail
141	TERRA ORTIZ DE TARANCO, ANA INÉS	Plaza Independencia 831 Of. 507	11000	2908.86.38	2908.86.40	bacot@bacot.com.uy
142	LARREA CASTRO, MAGELA ADRIANA	J.C.Gomez 1479	11100	2915.99.48		
143	SANTUCCI SCARLATO, ANA MARIA	Araucana 1312	11400	2600.21.03		
144	VANRELL FALCON, JUAN EDUARDO	Marco Bruto 1005, piso 5	11300	2628.60.33	2622.53.55	juanvanrell@vanrell.com.uy
145	LOPEZ OTTE, MARIO ANDRES	Araucana 1277	11400	2606.06.06	2606.14.39	cikato@cikato.com.uy
146	CAMPOS BARNECH, ENRIQUE FERNANDO	Paraguay 1196 esc. 002	11200	2901.46.44	2901.46.44	camposbarnech@hotmail.com
147	SCHULKIN GURMAN, AUGUSTO FERNANDO	Bulevar España 2293	11200	2401.09.94		
148	GARCIA GONZALEZ, SYLVIA ESTELA	Pablo Podestá 1293		-		
149	FERNANDEZ IRUJO, MARIA BEATRIZ	Pablo Pérez 4523		2215.11.32		
150	BAZZI GALLI, CARINNA GLORIA	Mercedes 1787		2400.91.36	2408.57.21	cbazzi@ertec.com.uy
151	GONZALEZ PITA, MARCELO JOSE	Pagola 3261 apto.104	11300	2709.25.65		
152	GIAMBRUNO MAROÑO, GABRIEL GERARDO	25 de Mayo 467 of. 401	11000	2916.19.13 AL 15	2916.57.40	fersecco@adinet.com.uy
153	TONARELLI DE PENNA, MARIA NOEL	25 de mayo 587 apto.101	11000	2916.54.92		
154	SCIARRA CAUBARRERE, ALEJANDRO	Rincón 531, Oficina 202		2916.66.45		sciarra@sciarra.com.uy
155	SCIARRA CAUBARRERE, ADRIANA	Lido 1621	11400	2604.38.59		
156	TEUTEN BROOKER, MARK CHRISTOPHER	WTC Torre III, Luis A. De Herrera 1248 Piso 15	11000	2908.86.38	2908.86.40	mteuten@cmlawyers.com.uy
157	ALVAREZ PERSICO, CARLOS	Pza. Cagancha 1335 esc. 206	11100	2902.31.18/ 2902.16.55	2902.13.44	jones@jones.com.uy
158	SUR BRAND, JORGE	Rambla República del Perú 851 ap.301	11300	2710.84.92		
159	ETCHEVERRY REYES, AGUSTIN	Cerrito 507 piso 5	11000	-		

Nro	Nombre	Dirección	CP	Teléfono	Fax	E-mail
160	SALAVERRY GALBARINI, LUCIA	Juan Carlos Gomez 1479 Esc 309	11000	2914.63.68	099611553	luciasalaverry@yahoo.com
161	STERENSTEIN PESQUERA, FERNANDO	Aurora 362		2309.35.86		
162	PEREYRA LETTIER, ROBERTO ELBIO	Vicente Yañez Pinzón 4743		2308.25.09		
163	LARMINY LOPEZ, EDGARDO	Juan Proudfoot 1764	12400	2321.18.57		elarminy@vera.com.uy
164	PEREIRA SARALEGUI, TORIBIO AMALIO	Rincón 528 piso 6	11000	2916.50.94/95	2916.13.59	tpereira@barbosa.com.uy
165	MORGADE DI POLITO, NORA	Rincón 528 piso 6	11000	2916.50.94/95	2916.13.59	barbosa@barbosa.com.uy
166	PASTORINO LEPIRA, CARLOS AMERICO	Feliciano Rodríguez 2709	11300	2709.04.12		
167	GALANTE ALVAREZ, DIEGO	Bulevar Artigas 1154	11300	2708.71.72	2708.71.72	info@galantemartins.com
168	CASULO BERNASCONI, EDISON HUMBERTO	José María Montero 2770	11308	099.612341	099.612341	info@legaluy.com
169	DETJEN ETCHEVERRIGARAY, XIMENA MARIA	Colonia 1561 apto. 201		2400.32.97		
170	BERRETA NOBOA, ALVARO RAFAEL	Av. Rivera 6606	11500	2600.82.41		
171	MARTINEZ GARCIA, MARIA CECILIA	J. Zavala Muniz 5556		2601.84.78	2601.84.78	reherma@adinet.com.uy
172	DE FREITAS STRAUMANN, EDUARDO	Andes 1418 apto. 201	11100	29011191/ 2902.53.03		
173	ELUTCHANZ GRAZIANO, NATALI CRISTINA	Maldonado 1378 apto.501		-		
174	CHALKLING MAJO, ANA CAROLINA	Luis B. Cavia 3071 Of. 904	11300	2708.40.13	2708.40.13	cchalkling@estudiochalkling.com
175	RUIZ ABOU-NIGM, VERONICA	Juncal 1327 esc. 2001	11000	2915.50.01	2915.43.75	marcas@ppv.com.uy
176	NOCETTI HERRERA, ANA AMELIA	Juncal 1392	11300	2900.10.00	2623.29.57	anocetti@ferrere.com
177	DEFFEMINIS PAIVA, JUAN BAUTISTA	Mones Roses 6937	11500	2604.16.04	2604.66.04	jdeffeminis@ppv.com.uy
178	LUSSICH, ALICIA	Yamandú Rodríguez 79 (Parque de Miramar) Canelones				
179	LARROSA DE BRUN, GUSTAVO	Calle Indiana s/n, M30 S2 (Médanos de Solymar) Canelones		098.03.91.70		gustavo@larrosaip.com.uy

Nro	Nombre	Dirección	CP	Teléfono	Fax	E-mail
180	CIKATO ABENTE, ANDRES	Araucana 1277	11400	2606.06.06	2606.14.39	cikato@cikato.com.uy
181	PITTALUGA PEREIRA, JUAN MARTIN	Echevarriarza 3535 Of. 1601 Torre A	11300	2623.29.59	2623.29.57	martin@pittaluga.com
182	BAZZANO OEHLER, VERONICA MARIA	Buenos Aires 618 piso 3	11100	2917.03.60	2916.09.92	fox@fox.com.uy
183	BUGALLO MONTAÑO, NYDIA BEATRIZ	Jaime Zudañez 2628 apto. 101	11300	2710.75.66		
184	ZERBINO STAJANO, RAFAEL AUGUSTO	Treinta y Tres 1271	11000	2916.03.10	2915.56.69	rzerbino@bkzr.com
185	CREMONESE MORETTO, CARMEN RAQUEL	Misiones 1475 esc. 202	11100	-		
186	CEA BACOT, MARÍA FERNANDA	Costa Rica 2003	11500	094.26.55.62		mceabacot@gmail.com
187	CESTAU FERNÁNDEZ, GRACIELA JOSEFINA	Pedro Murillo 6136	11500	2604.03.60		gcestau@fox.com.uy
188	ALZUGARAY GONZALEZ, ALICIA GOYA	Av. Pedro Blanes Viale 5919		2606.15.38		estudio@aya.com.uy
189	SARLABÓS BUZÓ, CARLOS EDUARDO	Brandzen 1961 Of. 205	11200	094383200 092073674		info@mercomark.com.uy
190	BARREIRO RIUS, MARÍA JACQUELINE	Misiones 1371 Esc. 31	11100	2915.17.34	2916.27.55	jbarreiro@lvm.com.uy
191	ESTEVEZ GOMEZ, HUGO WASHINGTON	WTC Torre III, Luis A. De Herrera 1248 Piso 15	11300	2622.99.90		hesteves@cmlawyers.com.uy
192	DUFRECHU RODRIGUEZ, DIEGO	Plaza Cagancha 1335 Of. 206	11100	2902.31.18/ 2902.16.55	2902.13.44	DDufrechu@jones.com.uy
193	SILVA ELIZALDE, ANA VICTORIA	Av. 18 de Julio 856 piso 5		2902.31.35		
194	FOX PEREYRA, VICTORIA HELENA	Pedro Murillo 6136	11500	2604.03.60	2604.66.69	vfox@fox.com.uy
195	BENTANCOR BENTANCOR, MARÍA CECILIA	Tomás Gomensoro 2984		2481.98.41	2481.98.41	cbentan@hotmail.com
196	FERNANDEZ BALLESTEROS, CARLOS ALBERTO	Piedras 509		2915.05.76		info@osfb.com.uy
197	SALGADO CARDOZO, VIVIAN DANIELA	Ramos 4234				
198	ROMANG COLOMINAS, CATHERINE	Misiones 1424 piso 2		2916.58.59	2916.58.63	cromang@olivera.com.uy

Nro	Nombre	Dirección	CP	Teléfono	Fax	E-mail
199	CHALAR SANZ, LAURA LUCIA	Misiones 1424 piso 2		2916.58.59	2916.58.63	lchalar@olidelp.com
200	STEINER DONNANGELO, ALMA	Colonia 810 esc. 703	11100	2900.97.30	2900.97.30	asteiner@als-abogados.com.uy
201	CIKATO ABENTE, MATIAS	Araucana 1277	11400	2606.06.06	2606.14.39	cikato@cikato.com.uy
202	PALADINO TURRA, NATALIA	WTC Torre III, Luis A. De Herrera 1248 Piso 15	11300	2622.99.90		npaladino@cmlawyers.com.uy
203	MATEOS TUCUNA, FABIANA	Marco Bruto 1005, piso 5	11300	2628.60.33	2622.53.55	fabianamateos@vanrell.com.uy
204	VANRELL FALCÓN, VERÓNICA LOURDES	Marco Bruto 1005, piso 5	11300	2628.60.33	2622.53.55	veronicavanrell@vanrell.com.uy
205	MAYER WEST, AGUSTÍN	Juncal 1392	11000	2900.10.00		amayer@ferrere.com
206	MATTSSON MOELLER, SIGRID ANNITA					mattrod@adinet.com.uy
207	FERNANDEZ REQUENA, ISABEL	25 de Mayo 467 piso 5	11000	2916.19.13	2916.57.40	ifernandez@fernandezsecco.com
208	PEREIRA, LEONARDO APARICIO	Arturo Santana 811, Esc. 002, Maldonado		4223.53.44 4224.43.57	4224.88.97	lapestudio@gmail.com
209	VALLEJO ESPÍÑEIRA, CECILIA MARIA	Andes 1293 esc. 501		2292.28.69		cvallejo@ciappesoni.com
210	LAPENNE DE SALTERAIN, MARCOS	Pedro Murillo 6136	11500	2604.03.60	2604.66.69	mlapenne@fox.com.uy
211	LAPENNE DE SALTERAIN, JUAN	Pedro Murillo 6136	11500	2604.03.60	2604.66.69	jlapenne@fox.com.uy
212	CERVIERI GHIOLDI, VIRGINIA	WTC Torre III, Luis A. De Herrera 1248 Piso 15	11300	2622.99.90		cervierimonsuarez@cmlawyers.com.uy
213	FERNÁNDEZ GIAMBRUNO, AGUSTINA MARÍA	25 de Mayo 467 piso 5	11000	2916.19.13	2916.57.40	afernandez@fernandezsecco.com
214	ACHARD SANCHEZ, JORGE LUIS	WTC Torre III, Luis A. De Herrera 1248 Piso 15				
215	ACOSTA PÉREZ, MARTÍN SEBASTIÁN	Soriano 895 Ap. 304				
216	PENADÉS GRAJALES, FABIANA VERÓNICA	Juncal 1355 of. 1101	11000	2916.65.68	2915.36.44	fpenades@clarkemodet.com.uy
217	BENITEZ ALVEZ, CARLOS EDGARDO	Marco Bruto 1005, piso 5	11300	2628.60.33	2622.53.55	carlosbenitez@vanrell.com.uy

Nro	Nombre	Dirección	CP	Teléfono	Fax	E-mail
218	WENG POLICICCHIO, STELLA MARINA	Juncal 1392	11000	2900.10.00		sweng@ferrere.com
219	CAMACHO CABRERA, MARITZA	Emilio Frugoni 886 apto. 401		24119600		aycmarcas@gmail.com
220	GALLO DUBOURG, ANDRÉS	Roque Graseras 661	11300	2716.77.69		info@mdubourg.com
221	ALTERWAIN BRUCK, ALEJANDRO	Juncal 1392	11000	2900.10.00		aalterwain@ferrere.com
222	ANTÚNEZ SEVESO, MÓNICA ANDREA	Avda. Giannatasio M10 S4, Local 7, Shangrilá, Ciudad de la Costa, Canelones				
223	ARAÚJO PERDOMO, XIMENA	Obligado 1208/102				
224	GOMENSORO VIDAL, NATALIA	Rincón 528 piso 6	11000	2916.50.94/95	2916.13.59	ngomensoro@barbosa.com.uy
225	IDOYAGA BARRO, ADOLFO MARIO	José Ellauri 7090/401				
226	GARIN da SILVA, DENIS FABIAN	Avenida Capitán Leal 5409				
227	BEZÓN RODRIGUEZ, STELLA MARIS	Durán 2131 ap. 104				
228	LANZON SEGOVIA, RAFAEL	Brandzen 1961, Piso 1 Esc.102	11200	2408.50.38	2409.97.61	rafael@lanzoni.com.uy
229	AMORÍN DEL CAMPO, BERNARDO JULIO					bamorin@amorinabogados.com
230	FISCHER CASTELLS, FEDERICO GUILLERMO	Liorna 6550				
231	FOX PEREYRA, MARIANA	Murillo 6136				mfox@fox.com.uy
232	PITTALUGA ROSSI, GABRIEL MARÍA	Echevarriarza 3535, esc. 1601				gabrielpittaluga1@gmail.com
233	MARY PATRICIA CHAVES TELIZ					dra.patriciachavesteliz@gmail.com
234	MANUELA CABRERA SALVO	Juan Paullier 1236				manuela.cabrera82@gmail.com
235	JONAS KING BERGSTEIN KLECKIN	Av. 18 de Julio 1117 Piso 5°				svila@bergsteinlaw.com
236	KAREN NAHIR FERNÁNDEZ SUÁREZ	Ituzaingo1312/201				Karenfernandezsuarez@gmail.com
237	JUAN JOSÉ CURONE SÁNCHEZ	Rio Branco 1481				juanjocurone@hotmail.com
238	ANA PAULA BIANCHIMANO LOPEZ	Buenos Aires 397 Esc. 601		29152804		
239	VILLAMIL RODRÍGUEZ, PABLO	Av. General Flores 2282 unidad 105	11800	2209.61.29 091.096.947		

Nro	Nombre	Dirección	CP	Teléfono	Fax	E-mail
240	PRIORE GONZALEZ , MARIA BELEN	Avenida Rivera 5511	11400	099.860.427		mbpriere@gmail.com
241	MARCELO FEMENIAS	Treinta y Tres 1271	11200			mfemenias@bkzr.com.uy
242	FLORENCIA TORRESANI	Indiana M30 S2 (Médanos de Solymar, Canelones)	11600			uruguay@balderip.com
243	ANDREA KARINA CALCATERRA	Carlos Puig 1514 (Dolores-Soriano)				
244	FELIPE MARTINEZ ARDOINO	Asturias 1496	11400			felipe@martinezleoni.com.uy
245	JUANA BACOT	25 de Mayo	11000			jbacot@bacot.com.uy
246	CARMELA BACOT KONKE	Echevarriarza 3406				cbacot@bacot.com.uy
247	ESTEBAN NICOLAS CABALLERO MADERA	Plaza Cagancha 1335 Of .206		29023118		ncaballero@jones.com.uy
248	MANUEL GRAÑA GIANONI	Jose Marti 3263 Apto 301		099043466		manuelg90@gmail.com
249	RUBEN GABRIEL MENDEZ IRIGOYEN	Gral. Flores 525 of. 004, Colonia del Sacramento, Colonia, UY				gabrielmendez272@gmail.com
250	GRISELDA HERNANDEZ LEIVA	Avda. Garibaldi 2185		22039306 098987250		griselda@medinamarcas.com
251	MATÍAS JACKSON BERTÓN	Guayabos 1718 Oficina 405				matias@jackson.com.uy
252	MARIA LAURA ESCUDERO AMBROSONI	JUNCAL 1431 Escritorio 501				mescudero@legalmind.com.uy
253	FEDERICO MARIA PEREZ DEL CASTILLO CHIAPPARA	Avenida Luis P. Ponce 1439				federico@perezdelcastillo.com
255	JUAN ANDRES VANRELL	Marco Bruto 1005, piso 5		095203681		juanandresvanrell@vanrell.com.uy

Advertencia.

“Es responsabilidad de los Sres. Agentes mantener actualizada la información precedente para su publicación en este Boletín, pudiendo solicitar los cambios que correspondan por correo electrónico dirigido a, Secretaria.DNPI@miem.gub.uy “

Todo usuario que haya presentado o presente una solicitud de registro mediante el Sistema de Presentación en Línea de la DNPI, deberá ingresar al mismo vía web para realizar el seguimiento de su solicitud, revisar los avisos de notificaciones pendientes, y proceder a notificarse. En caso de no seguir el procedimiento de notificación en línea en un plazo de 3 días hábiles, se tendrá por efectuada sin necesidad de constancia alguna comenzando a correr los plazos legales

SOLICITUDES DE MARCAS Y OTROS SIGNOS

Marcas Solicitadas

El procedimiento utilizado no permite en todos los casos reproducir con exactitud los distintos matices de los colores.

Para oír los audios de las Marcas Sonoras que se publiquen en el presente Boletín debe ingresar por el siguiente link

<https://www.gub.uy/ministerio-industria-energia-mineria/comunicacion/publicaciones/repositorio-marcas-sonoras>

(210) **554020** (540)
 (730) **Atanzio Investimentos Eireli**; BR
 (220) 29/08/2023
 (511) **35 (S/D) y 43 (S/D)**
 (740) Av. Fernando J. Carballo 2155, Colonia Del Sacramento, 70000, Colonia Del Sacramento, Franchising, UY

(591) Branco e Vermelho



(210) **555425** (540)
 (730) **KAREN SOSA BALDOVINO y JOHANA CURBELO CUSTODIO**; UY
 (220) 11/10/2023
 (511) **35 y 44**
 (740) Cooper 2105, Montevideo, , Montevideo, Montevideo, UY

(591) NEGRO - DORADO



(210) **556347** (540)
 (730) **ASOCIACION URUGUAYA DE ASADORES ASOCIACIÓN CIVIL**; UY
 (220) 10/11/2023
 (511) **41 (S/D)**
 (740) A.Zum Felde N° 2407, , , MONTEVIDEO, , UY

(591) BLANCO Y NEGRO



- (210) **558202** (540)
(730) **OTAIZA RODRIGUEZ BETIANA
YOSELYN Y VIROGA BRACCO
VICTORIA PAULA SOCIEDAD DE
HECHO; UY**
(220) 11/01/2024
(511) **1 (S/D) y 3 (S/D)**
(740) Santiago M 1 S 15, Sauce, 90800, Sauce,
Canelones, UY

(591) Blanco y negro



- (210) **558989** (540)
(730) **STILER S.A.; UY**
(220) 02/02/2024
(511) **35 y 36**
(740) 144



- (210) **559030** (540)
(730) **Golden Crop S.R.L.; UY**
(220) 05/02/2024
(511) **5 (S/D)**
(740) 12 de octubre sin número, Ituzaingó, San
José, Uruguay., Ituzaingó, 90200, Ituzaingó,
San José, UY

(591) Negro, blanco, amarillo.



(210) **559042** (540)
(730) **Gerardo Andrés FUERTE TRIAS**; UY
(220) 05/02/2024
(511) **35 (S/D) y 37 (S/D)**
(740) 254

(591) AZUL



(210) **559170** (540)
(730) **Wolf Oil Corporation N.V.**; BE
(220) 08/02/2024
(511) **1 (S/D) y 4 (S/D)**
(740) 144



(210) **559351** (540)
(730) **Scholl's Wellness Company LLC**; US
(220) 14/02/2024
(511) **3 (S/D), 10 (S/D) y 25 (S/D)**
(740) 144



- (210) **559383** (540)
(730) **GERARDO MARTIN LLOBET
MARTINEZ y ANGELICA CRISTINA
MAYA AGUILAR; CO**
(220) 15/02/2024
(511) **41 (S/D)**
(740) Santiago de Chile 1143/802, Montevideo,
11200, Montevideo, Montevideo, UY
- (591) Azul Persia #1E6C9E ; Rojo #E12D2F ; Gris
#9A9A99 ; Amarillo #F4DD0B y #FFEA18 ;
Azul magenta #241F4



- (210) **559389** (540)
(730) **Agustín Calvo; UY**
(220) 15/02/2024
(511) **41**
(740) García de Zúñiga 2245 apto 501, Montevideo,
11200, Montevideo, Montevideo, UY
- (591) Negro, blanco y celeste

MUY HUMANOS

- (210) **559417** (540)
(730) **INDÚSTRIA E COMÉRCIO SANTA
MARIA LTDA; BR**
(220) 16/02/2024
(511) **21**
(740) 201

SPLUM

(210) **559418** (540)
(730) **INDÚSTRIA E COMÉRCIO SANTA
MARIA LTDA; BR**
(220) 16/02/2024
(511) **21**
(740) 201

CORPUS

(210) **559428** (540)
(730) **BEATRIZ CARAMBULA; UY**
(220) 16/02/2024
(511) **35 y 36**
(740) 144

(591) Rojo, Magenta, Bordeaux, Blanco, Negro



(210) **559537** (540)
(730) **PICHNIY VIERA NADIA MICAELA; UY**
(220) 20/02/2024
(511) **35**
(740) 212

YOGUILOVER

(210) **559538** (540)
(730) **PICHNIY VIERA NADIA MICAELA; UY**
(220) 20/02/2024
(511) **41**
(740) 212

YOGUILOVER

(210) **559639** (540)
(730) **JUAN PABLO HELGUERA PEREIRA;**
UY
(220) 22/02/2024
(511) **35 y 36**
(740) luis piera 1921 piso 10, CIUDAD, ,
CIUDAD, MONTEVIDEO, UY

(591) NEGRO Y BLANCO



(210) **560065** (540)
(730) **Luis Ernesto Guerrero Domínguez; UY**
(220) 05/03/2024
(511) **30 (S/D)**
(740) Ingeniero Eladio Dieste S/n, esq. Miguelete,
Padrón 2391, Tarariras, 70600, Tarariras,
Colonia, UY

(591) gris, anaranjado, blanco, negro, marrón



(210) **560078**

(540)

(730) **DIGITAL BEAT PTE. LTD.**; SG

(220) 05/03/2024

(511) **9 (S/D)**

(740) 144

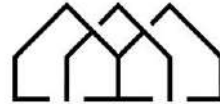

(210) **560079**

(540)

(730) **DIGITAL BEAT PTE. LTD.**; SG

(220) 05/03/2024

(511) **9 (S/D)**

(740) 144

H O M A T I C S

(210) **560115**

(540)

(730) **GALEMIN S.A.**; UY

(220) 06/03/2024

(511) **29 (S/D)**

(740) 189

(591) No se reivindican

ēretz
EXTRA VIRGIN
OLIVE OIL

(210) **560121** (540)
(730) **BRITOS PEREIRA CARLOS Y ACOSTA
GAMARRA LEIDY PAOLA SOCIEDAD
DE HECHO; UY**
(220) 06/03/2024
(511) **35**
(740) Paraguay 1695 Apto 301, Centro, 11100,
Centro, Montevideo, UY

(591) Rosado, Negro y Gris



(210) **560123** (540)
(730) **FOODOG COMPANY SAS; UY**
(220) 06/03/2024
(511) **31 (S/D)**
(740) CIUDADELA MANZANA 271 SOLAR 14,
El pinar, 15800, El pinar, Canelones, UY

(591) Verde (#8CBF42), naranja (#F29200) y
blanco



(210) **560125** (540)
(730) **GOAT LONDON CLOTHING LIMITED;
GB**
(220) 06/03/2024
(511) **25 (S/D)**
(740) Abadie santos 907, montevideo, 11200,
montevideo, montevideo, UY

(591) Blanco y negro



(210) **560129**

(730) **The Gillette Company LLC; US**

(220) 06/03/2024

(511) **8 (S/D)**

(740) 212

(540)



(210) **560130**

(730) **The Gillette Company LLC; US**

(220) 06/03/2024

(511) **8 (S/D)**

(740) 212

(540)



(210) **560135**

(730) **ULBRIKA URUGUAYA SOCIEDAD ANONIMA; UY**

(220) 06/03/2024

(511) **2**

(740) 144

(540)



(210) **560204** (540)
(730) **INSTITUTO NACIONAL DE
INVESTIGACION AGROPECUARIA
(INIA) y UNIVERSIDAD DE LA
REPUBLICA; UY**
(220) 07/03/2024
(511) **31**
(740) 34

MELBA

(210) **560205** (540)
(730) **INSTITUTO NACIONAL DE
INVESTIGACION AGROPECUARIA
(INIA) y UNIVERSIDAD DE LA
REPUBLICA; UY**
(220) 07/03/2024
(511) **31**
(740) 34

BÁMBOLA

(210) **560206** (540)
(730) **INSTITUTO NACIONAL DE
INVESTIGACION AGROPECUARIA
(INIA) y UNIVERSIDAD DE LA
REPUBLICA; UY**
(220) 07/03/2024
(511) **31**
(740) 34

BRIXY

(210) **560208** (540)
(730) **INSTITUTO NACIONAL DE
INVESTIGACION AGROPECUARIA
(INIA) y UNIVERSIDAD DE LA
REPUBLICA; UY**
(220) 07/03/2024
(511) **31**
(740) 34

FAGRO ARMONIA

(210) **560217** (540)
(730) **Corelux S.R.L.; UY**
(220) 07/03/2024
(511) **6 y 19**
(740) 101

(591) NEGRO, VERDE



(210) **560218** (540)
(730) **Corelux S.R.L.; UY**
(220) 07/03/2024
(511) **6 y 19**
(740) 101

ELEGANS

(210) **560245** (540)
(730) **ALEJANDRA LABRAGA**; UY
(220) 08/03/2024
(511) **35 (S/D) y 41 (S/D)**
(740) ARGONAUTA M 167 S 8, Neptunia, 15100,
Neptunia, Canelones, UY

TU MARCA, TU DIFERENCIA

(210) **560249** (540)
(730) **Emerald BioAgriculture Corp.**; US
(220) 08/03/2024
(511) **1 (S/D)**
(740) 144
(300) 98361296 17/01/2024 US

AUXIGRO

(210) **560258** (540)
(730) **OLD CHRISTIANS CLUB**; UY
(220) 08/03/2024
(511) **25**
(740) 221

OLD CHRISTIANS CLUB

(210) **560262**

(540)

(730) **OLD CHRISTIANS CLUB; UY**

(220) 08/03/2024

(511) **41**

(740) 221

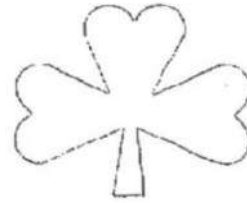

(210) **560265**

(540)

(730) **OLD CHRISTIANS CLUB; UY**

(220) 08/03/2024

(511) **25 y 41**

(740) 221

(591) amarillo, verde y azul.



(210) **560269**

(540)

(730) **Camara Uruguaya de Semillas; UY**

(220) 08/03/2024

(511) **31 y 35**

(740) 216

(591) Blanco, negro y gris



(210) **560295** (540)
(730) **Ayelen Mayuncaldy Dragolovich**; UY
(220) 08/03/2024
(511) **29, 30 y 31**
(740) 212

(591) Rojo, amarillo, negro y blanco



(210) **560345** (540)
(730) **SIGMA ALIMENTOS, S.A. DE C.V.**; MX
(220) 11/03/2024
(511) **29 (S/D) y 30 (S/D)**
(740) 201

(591) Rojo y Amarillo



(210) **560348** (540)
(730) **SIGMA ALIMENTOS, S.A. DE C.V.**; MX
(220) 11/03/2024
(511) **29 (S/D) y 30 (S/D)**
(740) 201

(591) Rojo y Amarillo



(210) **560429** (540)
(730) **EnTrans International, LLC; US**
(220) 13/03/2024
(511) **12 (S/D)**
(740) 144

ENTRANS

(210) **560430** (540)
(730) **EnTrans International, LLC; US**
(220) 13/03/2024
(511) **12 (S/D)**
(740) 144



(210) **560431** (540)
(730) **Heil Trailer International, LLC; US**
(220) 13/03/2024
(511) **12 (S/D)**
(740) 144

HEIL TRAILER

(210) **560432** (540)
(730) **Heil Trailer International, LLC; US**
(220) 13/03/2024
(511) **12 (S/D)**
(740) 144



(210) **560441** (540)
(730) **UNILAM S.A.; UY**
(220) 13/03/2024
(511) **2, 3, 5, 8, 10, 16, 18, 20, 21, 24, 25, 26, 27,**
28, 30, 35, 36, 37, 38, 39, 40, 43, 44 y 45
(740) 212

(591) Rojo, blanco y negro



(210) **560442** (540)
(730) **UNILAM S.A.; UY**
(220) 13/03/2024
(511) **2, 3, 5, 8, 10, 16, 18, 20, 21, 24, 25, 26, 27,**
28, 30, 35, 36, 37, 38, 39, 40, 43, 44 y 45
(740) 212

Guapa!

(210) **560443** (540)
(730) **UNILAM S.A;** UY
(220) 13/03/2024
(511) **2, 3, 5, 8, 10, 16, 18, 20, 21, 24, 25, 26, 27,**
28, 30, 35, 36, 37, 38, 39, 40, 43, 44 y 45
(740) 212

(591) blanco, rojo

Pappolino

(210) **560457** (540)
(730) **Sociedad Anónima Damm;** ES
(220) 13/03/2024
(511) **32 (S/D)**
(740) 181

(591) Blanco, Pantone 2035 C, Pantone Warm Grey
3C, Pantone Warm Grey 11c, Pantone Black
C, Oro



(210) **560472** (540)
(730) **PROMOTORA FARMACEUTICA SRL**
(También comercializada como
PROMOFARMA SRL); UY
(220) 14/03/2024
(511) **5**
(740) 220

Necessary  Promofarma

(210) **560473** (540)
(730) **PROMOTORA FARMACEUTICA SRL**
(También comercializada como
PROMOFARMA SRL); UY
(220) 14/03/2024
(511) **5**
(740) 220

NSSRY

(210) **560507** (540)
(730) **ADK Emotions Inc.**; JP
(220) 14/03/2024
(511) **9 (S/D) y 41 (S/D)**
(740) 221

BEYBLADE

(210) **560510** (540)
(730) **JURATOYS**; FR
(220) 14/03/2024
(511) **28**
(740) 34

JANOD

(210) **560520** (540)
(730) **SAMPER DIANO AMADEO; UY**
(220) 14/03/2024
(511) **18, 21, 25 y 28**
(740) 220



(210) **560525** (540)
(730) **GÓMEZ GERMANO, MARTÍN JAVIER;**
UY
(220) 15/03/2024
(511) **35**
(740) 189

(591) Blanco y celeste



(210) **560544** (540)
(730) **DELLATERRA SAS; UY**
(220) 15/03/2024
(511) **29, 30 y 40**
(740) 235



(210) **560568** (540)
(730) **DISTRIBUIDORA DEL POLO SAS; UY**
(220) 18/03/2024
(511) **25**
(740) 220

EURO KIDS

(210) **560572** (540)
(730) **TECNOAZUL SAS; UY**
(220) 18/03/2024
(511) **16 (S/D)**
(740) FRANCISCO DE CALDAS 1787,
MONTEVIDEO, 11400, MONTEVIDEO,
MONTEVIDEO, UY

(591) VERDE, GRIS, AZUL, BLANCO

BIENVASES

(210) **560603** (540)
(730) **NETAC TECHNOLOGY CO., LTD.; CN**
(220) 18/03/2024
(511) **9 (S/D)**
(740) 201
(300) 75831061 15/12/2023 CN

Netac

(210) **560606** (540)
(730) **Midea Group Co., Ltd.**; CN
(220) 18/03/2024
(511) **11 (S/D)**
(740) 201

ALL EASY

(210) **560607** (540)
(730) **Corteva Agriscience LLC**; US
(220) 18/03/2024
(511) **5 (S/D)**
(740) 144

INATREQ

(210) **560613** (540)
(730) **SHOULDER INDÚSTRIA E COMÉRCIO
DE CONFECÇÕES LTDA**; BR
(220) 18/03/2024
(511) **25 (S/D) y 35 (S/D)**
(740) 34

(591) BEIGE

shoulder

(210) **560614** (540)
(730) **ALBERTO MARTIN SCASSO**
VOLONTE; UY
(220) 18/03/2024
(511) **35, 38 y 41**
(740) Guayaqui 3425, Montevideo, , Montevideo,
Montevideo, UY

PUNTA DEL ESTE OPEN

(210) **560629** (540)
(730) **ASFALKOTE PENNSYLVANIA S.A.**; UY
(220) 19/03/2024
(511) **19**
(740) 129

MODULKOTE

(210) **560630** (540)
(730) **LABORATORIO LIBRA SOCIEDAD**
ANONIMA; UY
(220) 19/03/2024
(511) **5**
(740) 129

VASOPROT

(210) **560632** (540)
(730) **M.Elsa Vargas y B. Olivera Vargas y
Olivera; UY**
(220) 19/03/2024
(511) **32 (S/D)**
(740) Chiquito Saravia1325, Tacuarembó, 45000,
Tacuarembó, Tacuarembó, UY

Agua Batoví

(210) **560639** (540)
(730) **Chongqing Huayi Changshou Chemical
Group Co., Ltd; CN**
(220) 19/03/2024
(511) **17**
(740) 241

(591) NEGRO



(210) **560640** (540)
(730) **Bayer Aktiengesellschaft; DE**
(220) 19/03/2024
(511) **5 (S/D)**
(740) 221

WONDER

(210) **560642** (540)
(730) **Walter Castro**; UY
(220) 19/03/2024
(511) **41**
(740) Jade y rubi la fortuna, Maldonado, 20000,
Maldonado, Maldonado, UY

(591) blanco negro rojo azul amarillo rosa gris



(210) **560643** (540)
(730) **Dufry International AG (Dufry International SA) (Dufry International Ltd)**; CH
(220) 19/03/2024
(511) **35 (S/D)**
(740) 221
(300) 12200/2023 22/09/2023 CH

(D)Avolta

(210) **560645** (540)
(730) **Gaston Blanco**; UY
(220) 19/03/2024
(511) **35**
(740) Ruta 34 km44 s/n, RINCON DE PANDO, ,
RINCON DE PANDO, CANELONES, UY

PREMOLDEADOS DEL ESTE

(210) **560650** (540)
(730) **Corteva Agriscience LLC; US**
(220) 19/03/2024
(511) **5 (S/D)**
(740) 144

UNIVOQ

(210) **560652** (540)
(730) **ADAMA Makhteshim Ltd.; IL**
(220) 19/03/2024
(511) **5 (S/D)**
(740) 144

RINDASO

(210) **560653** (540)
(730) **ADAMA Makhteshim Ltd.; IL**
(220) 19/03/2024
(511) **5 (S/D)**
(740) 144

BALAVOR

(210) **560655** (540)
(730) **YIWU DEARBODY COSMETICS CO.,
LTD.;** CN
(220) 19/03/2024
(511) **3 (S/D)**
(740) 144



BEAUTY

(210) **560656** (540)
(730) **Gire S.A.;** AR
(220) 19/03/2024
(511) **35 y 36**
(740) 144



rapipago,

(210) **560657** (540)
(730) **YU SHENGFENG;** AR
(220) 19/03/2024
(511) **3 (S/D), 8 (S/D) y 35 (S/D)**
(740) 144



(210) **560658** (540)
(730) **WALRUS PUMP CO., LTD.**; TW
(220) 19/03/2024
(511) **7 (S/D)**
(740) 201

WALRUS

(210) **560659** (540)
(730) **FOODBOX SAS**; UY
(220) 19/03/2024
(511) **35**
(740) 186

(591) Pantone 326C

FOODBOX

(210) **560661** (540)
(730) **Banque Syz SA**; CH
(220) 19/03/2024
(511) **36 (S/D)**
(740) 201

SYZ

(210) **560662** (540)
(730) **PORTFOLIO CONCENTRATE**
SOLUTIONS UNLIMITED COMPANY;
IE
(220) 19/03/2024
(511) **33 (S/D)**
(740) 201

7UP COCKTAILS

(210) **560663** (540)
(730) **ZITRO LABORATORY S.L.U.; ES**
(220) 19/03/2024
(511) **9 (S/D) y 28 (S/D)**
(740) 220



(210) **560668** (540)
(730) **Red Barn Holdings, Inc.; US**
(220) 19/03/2024
(511) **7 (S/D), 9 (S/D), 11 (S/D), 40 (S/D) y 42**
(S/D)
(740) 194
(300) 98/382,609 30/01/2024 US
(591) verde, azul, blanco



(210) **560671** (540)
(730) **WTC FREE ZONE S.A.**; UY
(220) 19/03/2024
(511) **43**
(740) 34

(591) 0



(210) **560673** (540)
(730) **Mylan Inc.**; US
(220) 19/03/2024
(511) **5 (S/D), 10 (S/D) y 44 (S/D)**
(740) 194

(591) azul, violeta, amarillo



(210) **560674** (540)
(730) **Mylan Inc.**; US
(220) 19/03/2024
(511) **5 (S/D), 10 (S/D) y 44 (S/D)**
(740) 194

(591) -



(210) **560675** (540)
(730) **ESTEBAN AGUIRRE**; UY
(220) 19/03/2024
(511) **25**
(740) 212

(591) negro, verde, azul, rojo, lila, rosado



(210) **560681** (540)
(730) **Rodrigo Perlini**; UY
(220) 19/03/2024
(511) **28 (S/D) y 41 (S/D)**
(740) Maldonado 1933, 702, Montevideo, 11200,
Montevideo, Montevideo, UY

grupo RPM training

(210) **560682** (540)
(730) **Dufry International AG (Dufry International SA) (Dufry International Ltd)**; CH
(220) 19/03/2024
(511) **9 (S/D), 35 (S/D) y 43 (S/D)**
(740) 205
(300) 12201/2023 22/09/2023 CH

(D)Avolta

(210) **560691** (540)
(730) **PANDA FIREWORKS GROUP CO.,
LTD.;** CN
(220) 20/03/2024
(511) **13 (S/D)**
(740) 189

(591) Blanco y negro

PANDA

(210) **560703** (540)
(730) **Linde GmbH;** DE
(220) 20/03/2024
(511) **41 (S/D)**
(740) 192

(591) AZUL, CELESTE, BLANCO



(210) **560704** (540)
(730) **José Alborés;** UY
(220) 20/03/2024
(511) **9**
(740) Luis A. Surraco 2941 bis, Montevideo,
11600, Montevideo, Montevideo, UY

(591) 0



(210) **560708** (540)
(730) **DISTRIBUIDORA DEL POLO SAS; UY**
(220) 20/03/2024
(511) **25**
(740) 220



(210) **560709** (540)
(730) **LEONARDO ENRIQUE SANGUINETTI
PAIVA; UY**
(220) 20/03/2024
(511) **38 y 41**
(740) **LUIS ALBERTO DE HERRERA 2203,
Montevideo, , Montevideo, Montevideo, UY**

PROTAGONISTAS

(210) **560713** (540)
(730) **Augusto Cadenas; UY**
(220) 20/03/2024
(511) **6 (S/D) y 37 (S/D)**
(740) **Pablo de Maria 1283/304, Montevideo, ,
Montevideo, Montevideo, UY**

ALUCRIL

(210) **560715** (540)
(730) **CRAMON S.A.**; UY
(220) 20/03/2024
(511) **29**
(740) 221

Smaken

(210) **560716** (540)
(730) **ALDIESAN S.R.L.**; UY
(220) 20/03/2024
(511) **35**
(740) 254

(591) 5f5e5b, 687592, f8f5ef, c1a997, be8186,
c56166, aeb5bd, f1e3be



(210) **560720** (540)
(730) **THE POLO/LAUREN COMPANY, L.P.**;
US
(220) 20/03/2024
(511) **3 (S/D)**
(740) 144



(210) **560721** (540)
(730) **ALDIESAN S.R.L.**; UY
(220) 20/03/2024
(511) **35 y 40 (S/D)**
(740) 254

(591) 3b8281, e99342, 8eb4b4, f4f8f7, f6bf82,
9a807d, c4e0e6, 68b8bc



(210) **560722** (540)
(730) **ALDIESAN S.R.L.**; UY
(220) 20/03/2024
(511) **35 y 40**
(740) 254

(591) 181c1a, e8321f, f3f9f8, 979e9b, 737c77,
efa097, c3cac7, de8174



(210) **560723** (540)
(730) **ISLAMORADA SAS**; UY
(220) 20/03/2024
(511) **20 (S/D), 35 (S/D) y 42 (S/D)**
(740) Concepcion del Uruguay 1633/304,
Montevideo, 11400, Montevideo,
Montevideo, UY

BALI HAI

(210) **560724** (540)

(730) **ANA BOTTERO**; UY

(220) 20/03/2024

(511) **9 (S/D)**

(740) Estivao 1814, MONTEVIDEO, 11600,
MONTEVIDEO, Montevideo, UY

(591) AZUL VERDE BLANCO



(210) **560725** (540)

(730) **ALDIESAN S.R.L.**; UY

(220) 20/03/2024

(511) **2 (S/D), 16, 35 y 40 (S/D)**

(740) 254

(591) 3b7f9b, 94c2d3, f5fbfa, 80a1b0, c1e5f1,
74b4bc, 7cacb4, d8f6fb



(210) **560727** (540)

(730) **St. Dalfour International Incorporated**; US

(220) 20/03/2024

(511) **29 (S/D)**

(740) 181

JEAN FRANCOIS

(210) **560728** (540)
(730) **ALDIESAN S.R.L.**; UY
(220) 20/03/2024
(511) **35 y 40 (S/D)**
(740) 254

(591) d05649, eba69a, f5faf7, fad6c9, e4848c,
d49c7c, fadcdd, f4bcbc



(210) **560730** (540)
(730) **NESK CALÇADOS LTDA**; BR
(220) 20/03/2024
(511) **25**
(740) 212

NESK

(210) **560732** (540)
(730) **ALDIESAN S.R.L.**; UY
(220) 20/03/2024
(511) **35 y 41**
(740) 254

(591) 0e0e0e, f6e5db, f43404, 747474, eb3d0e,
e58065, 908e8e, d76346



(210) **560733** (540)
(730) **Bayer Aktiengesellschaft**; DE
(220) 20/03/2024
(511) **5 (S/D)**
(740) 205
(300) 018941110 24/10/2023 EM

SUNHARBO

(210) **560735** (540)
(730) **ALDIESAN S.R.L.**; UY
(220) 20/03/2024
(511) **35**
(740) 254

(591) b83c1c, 1e2027, b05e33, f1eeee, 91a9b8,
646772, 918976, a5cced, 5f84a3, c1deee



(210) **560737** (540)
(730) **Block, Inc.**; US
(220) 20/03/2024
(511) **9 (S/D), 36 (S/D) y 42 (S/D)**
(740) 212
(300) 98193552 22/09/2023 US

\$CASHTAG

(210) **560739** (540)
(730) **MICHEL NATALEVICH; UY**
(220) 20/03/2024
(511) **3**
(740) 179

CR CAIRUO

(210) **560741** (540)
(730) **FERNANDO DOÑO GOMEZ; UY**
(220) 20/03/2024
(511) **33**
(740) 179

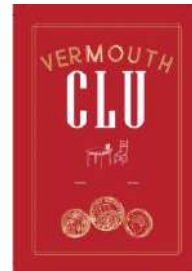

(210) **560743** (540)
(730) **Bayer Aktiengesellschaft; DE**
(220) 20/03/2024
(511) **5 (S/D)**
(740) 205
(300) 018941381 24/10/2023 EM

YAPAZVY

(210) **560745** (540)
(730) **UNIQUE SHIELD SDN BHD; MY**
(220) 20/03/2024
(511) **34 (S/D)**
(740) 185

SEVIOS

(210) **560746** (540)
(730) **UNIQUE SHIELD SDN BHD; MY**
(220) 20/03/2024
(511) **34 (S/D)**
(740) 185

SLEVIN

(210) **560747** (540)
(730) **Jeannine LAGUARDIA; UY**
(220) 20/03/2024
(511) **3 y 35 (S/D)**
(740) 254

(591) BLANCO Y NEGRO

DERMA
LAB

(210) **560748** (540)
(730) **UNIQUE SHIELD SDN BHD; MY**
(220) 20/03/2024
(511) **34 (S/D)**
(740) 185

IKLIM

(210) **560749** (540)
(730) **Bayer Aktiengesellschaft; DE**
(220) 20/03/2024
(511) **9 (S/D), 38 (S/D), 42 (S/D) y 44 (S/D)**
(740) 205

CORTENIC

(210) **560750** (540)
(730) **CURIARA FINANCIAL SERVICES INC.;**
US
(220) 20/03/2024
(511) **9 (S/D), 35 (S/D) y 36 (S/D)**
(740) 34

(591) CELESTE, GRIS



(210) **560751** (540)
(730) **ENTRASTE SAS; UY**
(220) 20/03/2024
(511) **41**
(740) 201

ENTRASTE

(210) **560752** (540)
(730) **Siegfried Rhein, S.A. de C.V.; MX**
(220) 20/03/2024
(511) **5 (S/D) y 32 (S/D)**
(740) 201

HYDRASHOT

(210) **560753** (540)
(730) **SEB DO BRASIL PRODUTOS
DOMESTICOS LTDA.; BR**
(220) 20/03/2024
(511) **7 (S/D)**
(740) 34

LAVETE

(210) **560755** (540)
(730) **Laboratorios Stein, S.A.**; CR
(220) 20/03/2024
(511) **5 (S/D)**
(740) 34

DATREXIA

(210) **560760** (540)
(730) **Gaston Gamieta**; AR
(220) 21/03/2024
(511) **42 (S/D)**
(740) Camino de los horneros 220, Ciudad de la
costa, 15800, Ciudad de la costa, Canelones,
UY

(591) ea2088 ffffff 3F4060 ee4fa1 e6e6e6 0b0c30
c4136e 737373 080b53



(210) **560762** (540)
(730) **XOANA SOFIA CÁCERES y SABRINA
AYLEN CÁCERES**; AR
(220) 21/03/2024
(511) **35**
(740) 28

(591) No reivindica



(210) **560770**
(730) **SharkNinja Operating LLC; US**
(220) 21/03/2024
(511) **10 (S/D) y 21 (S/D)**
(740) 216

(540)

SHARK

(210) **560779**
(730) **Honor Device Co., Ltd.; CN**
(220) 21/03/2024
(511) **9 (S/D)**
(740) 201
(300) 76421737 16/01/2024 CN

(540)

HONOR MAGIC V FLIP

(210) **560786**
(730) **TBN LOGÍSTICA Y OPERACIONES
PORTUARIAS S.A.S.; UY**
(220) 21/03/2024
(511) **35 y 39 (S/D)**
(740) 205

(540)

LHG LOGISTICA Y OPERACIONES PORTUARIAS

(210) **560787** (540)
(730) **Applied Felts, Inc.;** US
(220) 21/03/2024
(511) **19 (S/D)**
(740) 201

AQUACURE

(210) **560789** (540)
(730) **Applied Felts, Inc.;** US
(220) 21/03/2024
(511) **19 (S/D)**
(740) 201

ENVIROCURE

(210) **560790** (540)
(730) **Carolina Herrera Ltd;** US
(220) 21/03/2024
(511) **3 (S/D)**
(740) 245
(300) 4236805 20/10/2023 ES

LA BOMBA

(210) **560791**
(730) **Szabo S.A.**; UY
(220) 21/03/2024
(511) **5**
(740) 212

(540)

CONCIENCIA POR LA VIDA

(210) **560792**
(730) **Szabo S.A.**; UY
(220) 21/03/2024
(511) **5**
(740) 212

(540)

SERIM SIEGFRIED

(210) **560793**
(730) **Applied Felts, Inc.**; US
(220) 21/03/2024
(511) **17 (S/D)**
(740) 201

(540)

MAX CALTUBE

(210) **560794** (540)
(730) **Szabo S.A.**; UY
(220) 21/03/2024
(511) **5**
(740) 212

FLUVIX SIEGFRIED

(210) **560795** (540)
(730) **Szabo S.A.**; UY
(220) 21/03/2024
(511) **5**
(740) 212

COLPURIL SIEGFRIED

(210) **560797** (540)
(730) **SOSEI BIO SAS**; UY
(220) 21/03/2024
(511) **41, 42 y 44**
(740) 212

(591) amarillo, verde, negro, blanco



(210) **560798** (540)
(730) **BOSEI BIO SAS**; UY
(220) 21/03/2024
(511) **41, 42 y 44**
(740) 212

SALUD DEL SUELO

(210) **560799** (540)
(730) **Applied Felts, Inc.**; US
(220) 21/03/2024
(511) **19 (S/D)**
(740) 201

NOVAPIPE

(210) **560801** (540)
(730) **Applied Felts, Inc.**; US
(220) 21/03/2024
(511) **19 (S/D)**
(740) 201

ENVIROCURE UV

(210) **560806** (540)
(730) **Applied Felts, Inc.**; US
(220) 21/03/2024
(511) **17 (S/D)**
(740) 201

GHOSTLINER

(210) **560809** (540)
(730) **TRAFIMET GROUP S.P.A.**; IT
(220) 21/03/2024
(511) **7 (S/D), 9 (S/D) y 35 (S/D)**
(740) 144



(210) **560811** (540)
(730) **SUPERMERCADOS DISCO DEL
URUGUAY S.A.**; UY
(220) 21/03/2024
(511) **35**
(740) 144



(210) **560812** (540)
(730) **UPL Mauritius Limited; MU**
(220) 21/03/2024
(511) **5 (S/D)**
(740) 144

L-SPEC

(210) **560814** (540)
(730) **YOMANI S.A.; UY**
(220) 21/03/2024
(511) **12 y 20**
(740) 144

BEE.PET

(210) **560816** (540)
(730) **Maxliner LLC; US**
(220) 21/03/2024
(511) **7 (S/D)**
(740) 201

LINERGUN

(210) **560817** (540)
(730) **Anixter-Real Estate, LLC**; US
(220) 21/03/2024
(511) **9 (S/D), 35 (S/D), 37 (S/D) y 42 (S/D)**
(740) 194
(300) 98403478 (clases 9,35,37,42) 13/02/2024
US y 98412456 (clase 9) 20/02/2024 US

XPRESSCONNECT

(210) **560818** (540)
(730) **Maxliner LLC**; US
(220) 21/03/2024
(511) **17 (S/D)**
(740) 201

MAX FLEX 4D

(210) **560819** (540)
(730) **Maxliner LLC**; US
(220) 21/03/2024
(511) **7 (S/D)**
(740) 201

MAX LINERGUN

(210) **560820** (540)
(730) **Maxliner LLC**; US
(220) 21/03/2024
(511) **17 (S/D)**
(740) 201

MAX VERTIPOX

(210) **560821** (540)
(730) **Manantial de Azares S.A.S.**; UY
(220) 21/03/2024
(511) **36**
(740) 194

(591) -



(210) **560822** (540)
(730) **Maxliner LLC**; US
(220) 21/03/2024
(511) **7 (S/D) y 17 (S/D)**
(740) 201

MAXLIGHT

(210) **560824** (540)
(730) **Maxliner LLC**; US
(220) 21/03/2024
(511) **7 (S/D) y 17 (S/D)**
(740) 201

MAXLINER

(210) **560825** (540)
(730) **Manantial de Azares S.A.S.**; UY
(220) 21/03/2024
(511) **37**
(740) 194

(591) -



(210) **560826** (540)
(730) **KING'S EDUCATION LIMITED**; GB
(220) 21/03/2024
(511) **9 (S/D), 16 (S/D), 25 (S/D) y 41 (S/D)**
(740) 179
(300) M 4233360 26/09/2023 ES
(591) Azul, Rojo y Blanco.



(210) **560828**
(730) **Maxliner LLC**; US
(220) 21/03/2024
(511) **7 (S/D) y 37 (S/D)**
(740) 201

(540)



(210) **560830**
(730) **Maxliner LLC**; US
(220) 21/03/2024
(511) **17 (S/D)**
(740) 201

(540)

WOVOGLASS

(210) **560831**
(730) **Maxliner LLC**; US
(220) 21/03/2024
(511) **17 (S/D)**
(740) 201

(540)

WOVOLINER

(210) **560832** (540)
(730) **Maxliner LLC**; US
(220) 21/03/2024
(511) **17 (S/D)**
(740) 201

WOVOX

(210) **560836** (540)
(730) **Purenum GmbH**; DE
(220) 21/03/2024
(511) **5 (S/D) y 10 (S/D)**
(740) 219

mediNiK

(210) **560837** (540)
(730) **SEB DO BRASIL PRODUTOS
DOMESTICOS LTDA.**; BR
(220) 21/03/2024
(511) **7 (S/D)**
(740) 34

(591) rojo

ARNO

(210) **560838**
(730) **Beiersdorf AG; DE**
(220) 21/03/2024
(511) **3 (S/D)**
(740) 181

(540)

CITRACELL-PROTECT

(210) **560846**
(730) **Adalberto Juan FERREYRA URQUIZA;**
AR
(220) 21/03/2024
(511) **30 y 35 (S/D)**
(740) 254

(540)

(591) e2d5aa, e80524, b89b20, 74192f, 322329,
ab7333, 8d102a, b00a2b



(210) **560855**
(730) **SPACEDEV S.A.; UY**
(220) 22/03/2024
(511) **9 (S/D) y 42 (S/D)**
(740) 251

(540)

(591) Violeta



(210) **560858** (540)
(730) **EUROFARMA URUGUAY S.A.**; UY
(220) 22/03/2024
(511) **5**
(740) 201

PRINOX

(210) **560861** (540)
(730) **DISTRIBUIDORA DEL POLO SAS**; UY
(220) 22/03/2024
(511) **25**
(740) 220

EUROCONFORT

(210) **560863** (540)
(730) **INTERBLOCK D.O.O.**; US
(220) 22/03/2024
(511) **9 (S/D), 28 (S/D), 41 (S/D) y 42 (S/D)**
(740) 189
(300) 98209433 04/10/2023 US

ROULETTE FRENZY

(210) **560864** (540)
(730) **Taylor Made Golf Company, Inc.;** US
(220) 22/03/2024
(511) **25 (S/D) y 28 (S/D)**
(740) 194

TAYLORMADE

(210) **560865** (540)
(730) **SAMSUNG ELECTRONICS CO., LTD.;**
KR
(220) 22/03/2024
(511) **7 (S/D), 9 (S/D) y 11 (S/D)**
(740) 201

Daily Board

(210) **560866** (540)
(730) **Kia Corporation;** KR
(220) 22/03/2024
(511) **12 (S/D)**
(740) 201

Syros

(210) **560868** (540)
(730) **DIAMOND QUEST LIMITED; VG**
(220) 22/03/2024
(511) **34 (S/D)**
(740) 185

SAAT

(210) **560869** (540)
(730) **DIAMOND QUEST LIMITED; VG**
(220) 22/03/2024
(511) **34 (S/D)**
(740) 185

BLUE RANGE

(210) **560870** (540)
(730) **Dufry International AG (Dufry
International SA) (Dufry International
Ltd); CH**
(220) 22/03/2024
(511) **43 (S/D)**
(740) 205
(300) 12198/2023 22/09/2023 CH

(ID) Autogrill

(210) **560871** (540)
(730) **Dufry International AG (Dufry International SA) (Dufry International Ltd); CH**
(220) 22/03/2024
(511) **43 (S/D)**
(740) 205
(300) 12197/2023 22/09/2023 CH

 **HMSHost**

(210) **560874** (540)
(730) **Dufry International AG (Dufry International SA) (Dufry International Ltd); CH**
(220) 22/03/2024
(511) **35 (S/D)**
(740) 205
(300) 12195/2023 22/09/2023 CH

 **Dufry**

(210) **560875** (540)
(730) **PROWINCH, LLC; US**
(220) 22/03/2024
(511) **7 (S/D)**
(740) mercedes 941 apto.402, Montevideo, 11100, Montevideo, Montevideo, UY

(591) GRIS, NARANJA

 **ProWINCH**

(210) **560876** (540)
(730) **Dufry International AG (Dufry International SA) (Dufry International Ltd); CH**
(220) 22/03/2024
(511) **35 (S/D)**
(740) 205
(300) 12196/2023 22/09/2023 CH

 **Hudson**

(210) **560888** (540)
(730) **Dufry International AG (Dufry International SA) (Dufry International Ltd); CH**
(220) 22/03/2024
(511) **9 (S/D) y 35 (S/D)**
(740) 205
(300) 12293/2023 25/09/2023 CH

 **ClubVolta**

(210) **560899** (540)
(730) **Grupo Río de la Plata SAS; UY**
(220) 22/03/2024
(511) **37**
(740) Lago Ipoa, Club del lago, Punta Ballena, ,
Punta Ballena, maldonado, UY

LAS LILAS

(210) **560901** (540)

(730) **Anhui Jianghuai Automobile Group Corp.,
Ltd.**; CN

(220) 22/03/2024

(511) **35 (S/D) y 37 (S/D)**

(740) 94

(591) No reivindica colores



(210) **560902** (540)

(730) **URTADO MORALES DIEGO TABARE;
UY**

(220) 22/03/2024

(511) **6, 35 y 40**

(740) 144



plasmado

(210) **560905** (540)

(730) **COX ENERGY SOLAR, S.A.**; ES

(220) 22/03/2024

(511) **42 (S/D)**

(740) 144

COX

(210) **560907** (540)
(730) **Beiersdorf AG; DE**
(220) 22/03/2024
(511) **36 (S/D) y 41 (S/D)**
(740) 181

(591) Azul

**NIVEA
CONNECT**

(210) **560909** (540)
(730) **LABORATORIOS DE PRODUCTOS
ETICOS S.A.; PY**
(220) 22/03/2024
(511) **5**
(740) 201

TORALGIN

(210) **560910** (540)
(730) **HERMES INTERNATIONAL; FR**
(220) 22/03/2024
(511) **3 (S/D)**
(740) 144

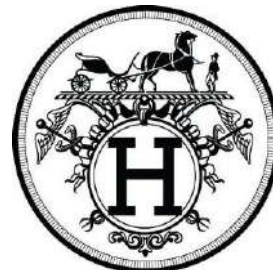

(210) **560912** (540)
(730) **LABORATORIOS DE PRODUCTOS**
ETICOS S.A.; PY
(220) 22/03/2024
(511) **35**
(740) 201

LABORATORIO DE PRODUCTOS ETICOS CEISA

(210) **560913** (540)
(730) **LABORATORIOS DE PRODUCTOS**
ETICOS S.A.; PY
(220) 22/03/2024
(511) **5**
(740) 201

ETISONA

(210) **560914** (540)
(730) **LABORATORIOS DE PRODUCTOS**
ETICOS S.A.; PY
(220) 22/03/2024
(511) **5 y 35**
(740) 201

(591) AZUL Y BLANCO



(210) **560916** (540)
(730) **Herbalife International, Inc.;** US
(220) 22/03/2024
(511) **3 (S/D), 5 (S/D), 29 (S/D), 30 (S/D), 32 (S/D)**
y 35 (S/D)
(740) 227

(591) -

The logo for Herbalife, featuring the word "Herbalife" in a bold, sans-serif font, with a stylized leaf icon to the right of the text.

(210) **560917** (540)
(730) **Herbalife International, Inc.;** US
(220) 22/03/2024
(511) **3 (S/D), 5 (S/D), 29 (S/D), 30 (S/D), 32 (S/D)**
y 35 (S/D)
(740) 227

(591) -



(210) **560922** (540)
(730) **MARTINEZ, MARCOS;** UY
(220) 22/03/2024
(511) **35, 41 y 44**
(740) 34

(591) Verde: #28A959, Negro: #000000, Blanco:
#FFFFFF

The logo for elequipo, featuring a green circular icon with a white stylized 'e' inside, followed by the word "elequipo" in a bold, lowercase, sans-serif font.

(210) **560924** (540)
(730) **REALCE ELETRODOMÉSTICOS**
LTDA; BR
(220) 22/03/2024
(511) **11**
(740) 34

(591) ROJO, AMARILLO



(210) **560927** (540)
(730) **SOPHIA HOLDINGS, S.A. DE C.V.; MX**
(220) 22/03/2024
(511) **41 (S/D)**
(740) 34

**OSIS (OCULAR SURFACE
INNOVATION SUMMIT)**

(210) **560932** (540)
(730) **EUROFARMA URUGUAY S.A.; UY**
(220) 22/03/2024
(511) **5**
(740) 201

VASCOR MR

(210) **560936** (540)
(730) **TOP2SELL SAS**; UY
(220) 22/03/2024
(511) **35**
(740) 194

(591) Pantones P 179-13 C y P 130-5 C

The logo for Top2Sell, featuring the word "Top" in black, "2" in a teal color, and "Sell" in black.

(210) **560938** (540)
(730) **CENTRO DE INTERVENCIONISMO
VASCULAR S A (CIVA SA)**; UY
(220) 22/03/2024
(511) **44**
(740) 101

The logo for CIVASA, consisting of the word "CIVASA" in a bold, black, sans-serif font.

(210) **560943** (540)
(730) **TREPPCO S.A.S.**; UY
(220) 01/04/2024
(511) **37**
(740) Juan Carlos Gomez 1348/102, Montevideo, ,
Montevideo, Montevideo, UY

(591) rojo y blanco

The logo for Treppco, featuring the word "Treppco" in a bold, red, sans-serif font.

(210) **560944** (540)
(730) **Tomra Systems ASA**; NO
(220) 01/04/2024
(511) **7 (S/D) y 40 (S/D)**
(740) 179
(300) 202312032 02/10/2023 NO

TOMRA T100

(210) **560945** (540)
(730) **TREPPCO S.A.S.**; UY
(220) 01/04/2024
(511) **37**
(740) Juan Carlos Gomez 1348/102, Montevideo, ,
Montevideo, Montevideo, UY

(591) rojo y blanco



(210) **560947** (540)
(730) **Alpha Plus Group Ltd**; UK
(220) 01/04/2024
(511) **9 (S/D), 16 (S/D), 25 (S/D) y 41 (S/D)**
(740) 179



(210) **560949** (540)
(730) **JB IP, LLC**; US
(220) 01/04/2024
(511) **25**
(740) 189

JUNGLE BOYS

(210) **560950** (540)
(730) **SELLANES RODRIGUEZ GABRIELA**
BEATRIZ; UY
(220) 01/04/2024
(511) **14 (S/D)**
(740) Roque Graseras 661, Montevideo, 11700,
Montevideo, Montevideo, UY



(210) **560954** (540)
(730) **Claudia Iris Mera Rodriguez**; UY
(220) 01/04/2024
(511) **41**
(740) 212

Semioyoga

(210) **560955** (540)
(730) **PABLO MIGUEL TROISE GOITIA; UY**
(220) 01/04/2024
(511) **4 (S/D)**
(740) BRITO FORESTI 3034, montevideo, ,
montevideo, Montevideo, UY

The logo for YAMAYA consists of the word "YAMAYA" in a bold, white, sans-serif font, centered within a red rectangular background.

(210) **560957** (540)
(730) **Myrian Adriana De Los Santos Fernández;**
UY
(220) 01/04/2024
(511) **30 (S/D) y 31 (S/D)**
(740) MAGALLANES 1412, MONTEVIDEO,
11000, MONTEVIDEO, MONTEVIDEO,
UY

(591) NEGRO, BLANCO, AMARILLO, ROJO,
NARANJA



(210) **560958** (540)
(730) **andrew de souza leal gonzalez; UY**
(220) 01/04/2024
(511) **10 (S/D)**
(740) Roger Ballet 2188, paysandu, 60000,
paysandu, Paysandu, UY

INSUMED SAS

(210) **560960** (540)
(730) **APPLE INC.**; US
(220) 01/04/2024
(511) **9 y 42**
(740) 245
(300) 90765 29/09/2023 JM
(591) -



(210) **560961** (540)
(730) **PROMOTORA FARMACEUTICA SRL**;
UY
(220) 01/04/2024
(511) **5**
(740) 220

nutralab

(210) **560962** (540)
(730) **BLUE ORIGIN MANAGEMENT**
CONSULTANT PTE. LTD.; SG
(220) 01/04/2024
(511) **35 (S/D)**
(740) 220

OH!SOME

(210) **560965** (540)

(730) **PETKIN DIS TICARET LIMITED**
SIRKETI; TR

(220) 01/04/2024

(511) **4 (S/D)**

(740) 192

(591) AMARILLO

The logo for GEMAOIL, featuring the word "GEMAOIL" in a bold, yellow, sans-serif font.

(210) **560968** (540)

(730) **GOODWE TECHNOLOGIES CO., LTD.;**
CN

(220) 01/04/2024

(511) **9 (S/D)**

(740) 94

(591) No reivindica colores

A stylized, black, bold letter 'W' logo.

(210) **560969** (540)

(730) **EUROFARMA URUGUAY S.A.;** UY

(220) 01/04/2024

(511) **5**

(740) 201

KLEAR TOS

(210) **560970** (540)
(730) **EUROFARMA URUGUAY S.A.;** UY
(220) 01/04/2024
(511) **5**
(740) 201

KLEAR PLUS

(210) **560971** (540)
(730) **FUJIAN HONGXING ERKE SPORTS**
GOODS CO., LTD.; CN
(220) 01/04/2024
(511) **25**
(740) 34

(591) 0



(210) **560972** (540)
(730) **Pastificio Selmi S / A;** BR
(220) 01/04/2024
(511) **30**
(740) 245

Todeschini

(210) **560974** (540)
(730) **PEBEPE ASOCIADOS SRL; UY**
(220) 01/04/2024
(511) **43**
(740) 194

(591) #0075fa, #ed6335



(210) **560976** (540)
(730) **TECNOFILES S.A.; AR**
(220) 01/04/2024
(511) **17, 19 y 35**
(740) 201

(591) Verde: PANTONE 383C / Naranja:
PANTONE 158C



(210) **560978** (540)
(730) **APITORIA PHARMA PRIVATE
LIMITED; IN**
(220) 01/04/2024
(511) **5 (S/D)**
(740) 34

(591) AZUL, ROJO, VIOLETA, BLANCO



(210) **560981** (540)
(730) **KIMBERLY-CLARK WORLDWIDE,
INC.; US**
(220) 01/04/2024
(511) **3 (S/D) y 25 (S/D)**
(740) 201

POISE

(210) **560983** (540)
(730) **ECUATORIANA DE PRODUCTOS
ELECTRONICOS S.A. IEPESA; EC**
(220) 01/04/2024
(511) **20**
(740) 194

(591) ROJO, AZUL



(210) **560984** (540)
(730) **GAC AION NEW ENERGY
AUTOMOBILE CO., LTD.; CN**
(220) 01/04/2024
(511) **7 (S/D), 9 (S/D), 12 (S/D), 35 (S/D) y 37
(S/D)**
(740) 34

(591) 0



(210) **560985**
(730) **Salesforce, Inc.**; US
(220) 01/04/2024
(511) **9 (S/D) y 42 (S/D)**
(740) 201

(540)



(210) **560986**
(730) **South Star Group International, Inc.**; PA
(220) 01/04/2024
(511) **33 (S/D)**
(740) 245

(540)

SOUTH STAR

(210) **560987**
(730) **ACOSTA, HUGO GERMAN**; AR
(220) 01/04/2024
(511) **35**
(740) 201

(540)

KRATOS ACCESORIOS

(210) **560989** (540)
(730) **TICKET AGORA SERVIÇOS DE
RESERVA, INTERMEDIÇÃO E
AGENCIAMENTO LTDA.; BR**
(220) 01/04/2024
(511) **35 (S/D)**
(740) 34

(591) 0



(210) **560991** (540)
(730) **TUTEUR S.A.C.I.F.I.A.; AR**
(220) 01/04/2024
(511) **10 (S/D)**
(740) 201

TISURAL

(210) **560993** (540)
(730) **Laboratorios Stein, S.A.; CR**
(220) 01/04/2024
(511) **5 (S/D)**
(740) 34

UZTOK

(210) **560996** (540)
(730) **SILVA BENIN STEPHANY GISSEL**
UNIPERSONAL; UY
(220) 01/04/2024
(511) **16 (S/D)**
(740) Coronel Abreu M18S12, El pinar, 15800, El
pinar, Canelones, UY

MAKY

(210) **560997** (540)
(730) **TUTEUR S.A.C.I.F.I.A.; AR**
(220) 01/04/2024
(511) **10 (S/D)**
(740) 201

TREXONIL

(210) **561000** (540)
(730) **Celltrion Holdings Co., Ltd.; KR**
(220) 01/04/2024
(511) **5 (S/D)**
(740) 201

(591) VERDE

Celltrion

(210) **561003** (540)
(730) **The Procter & Gamble Company; US**
(220) 01/04/2024
(511) **5 (S/D)**
(740) 212

BARREIRA ANTI-COCÔ

(210) **561005** (540)
(730) **IGS ALUMINIO SOCIEDAD ANONIMA;**
UY
(220) 01/04/2024
(511) **6, 19, 35 y 37**
(740) 194

(591) PANTONE 646C



(210) **561007** (540)
(730) **SKY AIRLINE S.A.; CL**
(220) 01/04/2024
(511) **35 (S/D), 36 (S/D) y 39 (S/D)**
(740) 205

SKYPLUS

(210) **561010** (540)

(730) **AUSTRAL SOFTWARE
DEVELOPMENT SAS; UY**

(220) 01/04/2024

(511) **37 y 42**

(740) PLAZA INDEPENDENCIA 831 OFICINA
609, MONTEVIDEO, , MONTEVIDEO,
MONTEVIDEO, UY

(591) blanco y verde

 Dashboard

(210) **561016** (540)

(730) **AUSTRAL SOFTWARE
DEVELOPMENT SAS; UY**

(220) 01/04/2024

(511) **37 y 42**

(740) PLAZA INDEPENDENCIA 831 OFICINA
609, MONTEVIDEO, , MONTEVIDEO,
MONTEVIDEO, UY

(591) blanco, verde y gris

 Collect

(210) **561018** (540)

(730) **TROFONI SRL; UY**

(220) 01/04/2024

(511) **29**

(740) 193

Paltolea

(210) **561019** (540)
(730) **AUSTRAL SOFTWARE**
DEVELOPMENT SAS; UY
(220) 01/04/2024
(511) **37 y 42**
(740) PLAZA INDEPENDENCIA 831 OFICINA
609, MONTEVIDEO, , MONTEVIDEO,
MONTEVIDEO, UY

(591) marrón, blanco y gris



(210) **561020** (540)
(730) **Space Exploration Technologies Corp.; US**
(220) 01/04/2024
(511) **9 (S/D), 38 (S/D), 39 (S/D) y 42 (S/D)**
(740) 245
(300) 98242268 26/10/2023 US
(591) -

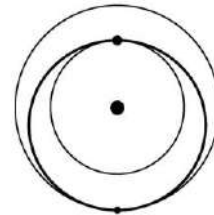

(210) **561021** (540)
(730) **SOFTYS S.A.; CL**
(220) 01/04/2024
(511) **16 (S/D)**
(740) 205

(591) Tonos de azul, blanco, gris, verde, negro



(210) **561022** (540)

(730) **AUSTRAL SOFTWARE
DEVELOPMENT SAS; UY**

(220) 01/04/2024

(511) **37 y 42**

(740) PLAZA INDEPENDENCIA 831 OFICINA
609, MONTEVIDEO, , MONTEVIDEO,
MONTEVIDEO, UY

(591) blanco, verde oscuro y gris



(210) **561023** (540)

(730) **AUSTRAL SOFTWARE
DEVELOPMENT SAS; UY**

(220) 01/04/2024

(511) **37 y 42**

(740) PLAZA INDEPENDENCIA 831 OFICINA
609, MONTEVIDEO, , MONTEVIDEO,
MONTEVIDEO, UY

(591) celeste, blanco y gris



(210) **561024** (540)

(730) **SZABO S.A.; UY**

(220) 01/04/2024

(511) **9, 35, 36, 38 y 42**

(740) 212

FarmaPay

(210) **561026** (540)
(730) **Taylor Made Golf Company, Inc.**; US
(220) 01/04/2024
(511) **25 (S/D) y 28 (S/D)**
(740) 194



(210) **561031** (540)
(730) **Hebei Tiger Tooth Machinery Parts Co., LTD**; CN
(220) 02/04/2024
(511) **12 (S/D)**
(740) 144

TIGER TOOTH

(210) **561034** (540)
(730) **LUXOTTICA GROUP S.P.A.**; IT
(220) 02/04/2024
(511) **9 (S/D), 35 (S/D) y 40 (S/D)**
(740) 144
(300) 302023000171222 23/02/2024 IT



(210) **561037** (540)
(730) **ODALER S.A.**; UY
(220) 02/04/2024
(511) **35**
(740) 144



(210) **561042** (540)
(730) **Fernando Johann**; AR
(220) 02/04/2024
(511) **25 (S/D)**
(740) Gabriel Pereira 3113, apto 401, Montevideo,
11300, Montevideo, Montevideo, UY

Consiguelo Aqui

(210) **561045** (540)
(730) **Martin Ortiz Villa; José María Díaz**
Couselo; Ana María Fuentes y Clara
Carluccio; AR
(220) 02/04/2024
(511) **36**
(740) 154

LOS PEREGRINOS

(210) **561046** (540)
(730) **PAPPA, CARLOS ALBERTO**; AR
(220) 02/04/2024
(511) **28 (S/D)**
(740) 189



(210) **561047** (540)
(730) **PUNKTAL S.A.**; UY
(220) 02/04/2024
(511) **8**
(740) 189

PUNKTAL

(210) **561049** (540)
(730) **DE LEON ESQUIBEL FLORENCIA**; UY
(220) 02/04/2024
(511) **25**
(740) 220

(591) celeste



(210) **561052** (540)
(730) **L´Jolgue Business Trading SAS; UY**
(220) 02/04/2024
(511) **10**
(740) 216

(591) Negro, gris y blanco.



(210) **561053** (540)
(730) **Société des Produits Nestlé S.A.; CH**
(220) 02/04/2024
(511) **5 (S/D), 29 (S/D), 30 (S/D) y 32 (S/D)**
(740) 156



(210) **561054** (540)
(730) **MUSE CONCEPT; FR**
(220) 02/04/2024
(511) **9 (S/D) y 11 (S/D)**
(740) 154

(591) Blanco y gris oscuro



(210) **561058** (540)
(730) **Agustin Nicolas Penino Delgado**; UY
(220) 02/04/2024
(511) **25 (S/D), 28 (S/D), 34 (S/D) y 42 (S/D)**
(740) Ignacio Nuñez 2209, La Blanqueada, 11600,
La Blanqueada, Montevideo, UY

(591) Primario: 348b97, Secundario(fondo):
transparente, blanco o negro.



(210) **561063** (540)
(730) **BUNTECH, TECNOLOGIA EM
INSUMOS LTDA.**; BR
(220) 02/04/2024
(511) **1 (S/D)**
(740) 144

(591) azul, verde



(210) **561066** (540)
(730) **GNOSIS S.p.A.**; IT
(220) 02/04/2024
(511) **5 (S/D)**
(740) 144

QUATREFOLIC

(210) **561067** (540)
(730) **JBM Geio, S.L.**; ES
(220) 02/04/2024
(511) **7 (S/D) y 8 (S/D)**
(740) 144



(210) **561070** (540)
(730) **NOLADRIL S.A.**; UY
(220) 02/04/2024
(511) **9**
(740) 201

(591) AZUL PANTONE 2131C, VIOLETA
PANTONE 2098C, NEGRO, BLANCO



(210) **561071** (540)
(730) **NOLADRIL S.A.**; UY
(220) 02/04/2024
(511) **36 y 42**
(740) 201

(591) AZUL PANTONE 2131C, VIOLETA
PANTONE 2098C, NEGRO, BLANCO



(210) **561072** (540)
(730) **226ERS SPORTS THINGS, S.L.**; ES
(220) 02/04/2024
(511) **5 (S/D), 25 (S/D), 30 (S/D) y 32 (S/D)**
(740) 144

226ERS

(210) **561077** (540)
(730) **Scavone Hermanos S.A.**; PY
(220) 02/04/2024
(511) **5**
(740) 201

TORALGIN

(210) **561079** (540)
(730) **JNTL Consumer Health I (Switzerland)**
GmbH; CH
(220) 02/04/2024
(511) **3 (S/D)**
(740) 194



(210) **561082** (540)
(730) **TARGET GESTÃO DE MARCAS E
PATENTES LTDA.; BR**
(220) 02/04/2024
(511) **7 (S/D)**
(740) 201

[TKA]

(210) **561083** (540)
(730) **MARKWINS BEAUTY BRANDS
INTERNATIONAL Ltd.; UK**
(220) 02/04/2024
(511) **3 (S/D), 8 (S/D) y 21 (S/D)**
(740) 179

bonvoyage

(210) **561084** (540)
(730) **AUSTRAL SOFTWARE
DEVELOPMENT SAS; UY**
(220) 02/04/2024
(511) **37 y 42**
(740) **PLAZA INDEPENDENCIA 831 OFICINA
609, MONTEVIDEO, , MONTEVIDEO,
MONTEVIDEO, UY**

(591) fucsia, blanco y gris

 **Project**

(210) **561085** (540)
(730) **AUSTRAL SOFTWARE**
DEVELOPMENT SAS; UY
(220) 02/04/2024
(511) **37 y 42**
(740) PLAZA INDEPENDENCIA 831 OFICINA
609, MONTEVIDEO, , MONTEVIDEO,
MONTEVIDEO, UY

(591) rojo, blanco y gris



(210) **561086** (540)
(730) **TA-TA S.A.; UY**
(220) 02/04/2024
(511) **38**
(740) 245

(591) Anaranjado, blanco y negro



(210) **561087** (540)
(730) **AUSTRAL SOFTWARE**
DEVELOPMENT SAS; UY
(220) 02/04/2024
(511) **37 y 42**
(740) PLAZA INDEPENDENCIA 831 OFICINA
609, MONTEVIDEO, , MONTEVIDEO,
MONTEVIDEO, UY

(591) naranja, blanco y gris



(210) **561089** (540)
(730) **AUSTRAL SOFTWARE
DEVELOPMENT SAS; UY**
(220) 02/04/2024
(511) **37 y 42**
(740) PLAZA INDEPENDENCIA 831 OFICINA
609, MONTEVIDEO, , MONTEVIDEO,
MONTEVIDEO, UY

(591) gris y blanco



(210) **561090** (540)
(730) **AUSTRAL SOFTWARE
DEVELOPMENT SAS; UY**
(220) 02/04/2024
(511) **37 y 42**
(740) PLAZA INDEPENDENCIA 831 OFICINA
609, MONTEVIDEO, , MONTEVIDEO,
MONTEVIDEO, UY

(591) verde, blanco y gris



(210) **561091** (540)
(730) **AMBIPAR PARTICIPAÇÕES E
EMPREENDIMIENTOS S.A.; BR**
(220) 02/04/2024
(511) **39 (S/D), 40 (S/D) y 42 (S/D)**
(740) 34

AMBIPAR ENVIRONMENT

(210) **561092** (540)
(730) **ZHEJIANG QIANTAO PUMPS CO.,
LTD.;** CN
(220) 02/04/2024
(511) **7 (S/D)**
(740) 34

(591) 0



(210) **561094** (540)
(730) **Mustad Hoofcare S.A;** CH
(220) 02/04/2024
(511) **6 (S/D)**
(740) 34

(591) 0



(210) **561096** (540)
(730) **EAE ELEKTRIK ASANSÖR
ENDÜSTRISI INSAAT SANAYI VE
TICARET ANONIM SİRKETİ;** TR
(220) 02/04/2024
(511) **9 y 11**
(740) 34

(591) ROJO, BLANCO



(210) **561098** (540)
(730) **Ecolab USA Inc.**; US
(220) 02/04/2024
(511) **5 (S/D)**
(740) 212

ZEPHAIR

(210) **561099** (540)
(730) **KING MAKER MARKETING, INC.**; US
(220) 02/04/2024
(511) **34 (S/D)**
(740) 212

GRAYSONS

(210) **561120** (540)
(730) **florencia avellino**; AR
(220) 03/04/2024
(511) **25**
(740) 579 Bv. Gral. Artigas, 101, Montevideo,
11300, Montevideo, Departamento de
Montevideo, UY

galio brand

(210) **561128** (540)
(730) **Inspired Education Holdings Limited; UK**
(220) 03/04/2024
(511) **9 (S/D), 16 (S/D), 25 (S/D) y 41 (S/D)**
(740) 179
(300) A 19008638 EM 03/04/2024 EM
(591) Gris, Azul

inspired

(210) **561129** (540)
(730) **MICRUS S.A.; UY**
(220) 03/04/2024
(511) **33 y 35**
(740) 221

(591) Bordó, negro y blanco



(210) **561142** (540)
(730) **ULBRIKA URUGUAYA S.A.; UY**
(220) 03/04/2024
(511) **2**
(740) 144

DEKORIT

(210) **561143**
(730) **INTERPARFUMS S.A.**; FR
(220) 03/04/2024
(511) **3 (S/D)**
(740) 144
(300) 5003448 03/11/2023 FR

(540)

BAISER PLACE VENDÔME

(210) **561144**
(730) **INTERPARFUMS S.A.**; FR
(220) 03/04/2024
(511) **3 (S/D)**
(740) 144
(300) 5003450 03/11/2023 FR

(540)

THÉ AU PALAIS ROYAL

(210) **561145**
(730) **LOUIS DREYFUS TRADEMARKS B.V.**;
NL
(220) 03/04/2024
(511) **9 (S/D) y 35 (S/D)**
(740) 144

(540)



(210) **561146** (540)
(730) **BUNTECH, TECNOLOGIA EM
INSUMOS LTDA.; BR**
(220) 03/04/2024
(511) **31 (S/D)**
(740) 144

(591) Verde y Blanco



(210) **561148** (540)
(730) **LUMINOVA PHARMA CORPORATION
GmbH; CH**
(220) 03/04/2024
(511) **5 (S/D)**
(740) 212

OMIPRE AMLO

(210) **561149** (540)
(730) **LUMINOVA PHARMA CORPORATION
GmbH; CH**
(220) 03/04/2024
(511) **5 (S/D)**
(740) 212

DEMEZILO

(210) **561151** (540)
(730) **FONDO SOCIAL DE LA
CONSTRUCCIÓN (ASOCIACION
CIVIL); UY**
(220) 03/04/2024
(511) **36**
(740) 34

(591) 0



(210) **561152** (540)
(730) **FONDO SOCIAL DE LA
CONSTRUCCIÓN (ASOCIACION
CIVIL); UY**
(220) 03/04/2024
(511) **36**
(740) 34

**FONDO SOCIAL DE LA
CONSTRUCCIÓN**

(210) **561154** (540)
(730) **FONDO SOCIAL DE LA
CONSTRUCCIÓN (ASOCIACION
CIVIL); UY**
(220) 03/04/2024
(511) **36**
(740) 34

(591) 0



(210) **561155** (540)
(730) **Mary Kay Inc.**; US
(220) 03/04/2024
(511) **3 (S/D)**
(740) 212

LASH LOVE FANORAMA

(210) **561168** (540)
(730) **DACONAL S.A.**; UY
(220) 04/04/2024
(511) **7 y 9**
(740) 201

(591) AZUL, VERDE, CELESTE, BLANCO



(210) **561169** (540)
(730) **Luis Brambillasca**; UY
(220) 04/04/2024
(511) **45 (S/D)**
(740) Peatonal Sarandi 594, Montevideo, ,
Montevideo, Montevideo, UY

(591) AMARILLO Y AZUL



(210) **561170** (540)
(730) **GRUPO DELTRON S.A.**; PE
(220) 04/04/2024
(511) **9 (S/D)**
(740) 254

TEROS LETS MOVE ON

(210) **561171** (540)
(730) **PESOS Y DOLARES SAS**; UY
(220) 04/04/2024
(511) **36**
(740) 220



Pesos & Dólares

(210) **561172** (540)
(730) **S.A. MOLINOS ARROCEROS**
NACIONALES (SAMAN); UY
(220) 04/04/2024
(511) **30**
(740) 217

**CHOCO CANICAS LA
ABUNDANCIA**

(210) **561174** (540)
(730) **NARNAN S.R.L.**; UY
(220) 04/04/2024
(511) **41**
(740) GARZON AVDA. GRAL. EUGENIO 2027,
Montevideo, , Montevideo, Montevideo, UY

(591) Verde, Negro y Gris



(210) **561178** (540)
(730) **ROLEX SA**; CH
(220) 04/04/2024
(511) **14 (S/D)**
(740) 144

**SUPERLATIVE
CHRONOMETER**

(210) **561180** (540)
(730) **INDUSTRIA DE DISEÑO TEXTIL S.A.**
(INDITEX S.A.); ES
(220) 04/04/2024
(511) **9, 18 y 25**
(740) 201



(210) **561183** (540)
(730) **INDUSTRIAL DELIGHTS S.A. (INDEL S.A.); PY**
(220) 04/04/2024
(511) **30 (S/D)**
(740) 179



(210) **561186** (540)
(730) **Lila Magnone Dos Santos; UY**
(220) 04/04/2024
(511) **43**
(740) 194

(591) -



(210) **561189** (540)
(730) **PASQUET GERSTLE, ANDRES; UY**
(220) 04/04/2024
(511) **35**
(740) 201

MERCOPLUS LATAM

(210) **561197** (540)
(730) **AUTOMOBILI LAMBORGHINI S.p.A.;**
IT
(220) 04/04/2024
(511) **9 (S/D), 12 (S/D), 25 (S/D) y 28 (S/D)**
(740) 201
(300) 019007533 02/04/2024 EM

TEMERARIO

(210) **561203** (540)
(730) **Tesorería Sudamericana Sociedad**
Anónima; UY
(220) 04/04/2024
(511) **33 y 43**
(740) 248

(591) negro, verde, violeta, blanco



(210) **561205** (540)
(730) **FGMM HOLDING COMPANY LLC; US**
(220) 05/04/2024
(511) **9 (S/D), 10 (S/D) y 35 (S/D)**
(740) 189

(591) Gris, blanco, celeste



(210) **561207** (540)

(730) **César Waldemar Eguren Figueroa; UY**

(220) 05/04/2024

(511) **3**

(740) 192

(591) 0



(210) **561208** (540)

(730) **L'AIR LIQUIDE, SOCIETE ANONYME
POUR L'ETUDE ET L'EXPLOITATION
DES PROCEDES GEORGES CLAUDE;
FR**

(220) 05/04/2024

(511) **1 (S/D)**

(740) 192

ALPHAGAZ

(210) **561214** (540)

(730) **AUDAX QUIMICA INDUSTRIA E
COMERCIO DE PRODUTOS PARA
HIGIENE E LIMPEZA LTDA.; BR**

(220) 05/04/2024

(511) **3 (S/D)**

(740) 192

AUDAX FACILITA

(210) **561218** (540)
(730) **L'AIR LIQUIDE, SOCIETE ANONYME
POUR L'ETUDE ET L'EXPLOITATION
DES PROCEDES GEORGES CLAUDE;**
FR
(220) 05/04/2024
(511) **1 (S/D)**
(740) 192

PHARGALIS

(210) **561220** (540)
(730) **L'AIR LIQUIDE, SOCIETE ANONYME
POUR L'ETUDE ET L'EXPLOITATION
DES PROCEDES GEORGES CLAUDE;**
FR
(220) 05/04/2024
(511) **1 (S/D) y 39 (S/D)**
(740) 192

(591) AZUL

ECO ORIGIN

(210) **561222** (540)
(730) **L'AIR LIQUIDE, SOCIETE ANONYME
POUR L'ETUDE ET L'EXPLOITATION
DES PROCEDES GEORGES CLAUDE;**
FR
(220) 05/04/2024
(511) **6 (S/D) y 11 (S/D)**
(740) 192

(591) AZUL

SMARTOP

(210) **561224** (540)
(730) **L'AIR LIQUIDE, SOCIETE ANONYME
POUR L'ETUDE ET L'EXPLOITATION
DES PROCEDES GEORGES CLAUDE;**
FR
(220) 05/04/2024
(511) **1 (S/D)**
(740) 192

LASAL

(210) **561227** (540)
(730) **BUDASOFF, FEDERICO ARIEL; AR**
(220) 05/04/2024
(511) **34 (S/D)**
(740) 185

(591) NARANJA, BLANCO, GRIS, NEGRO Y
ROSA CLARO

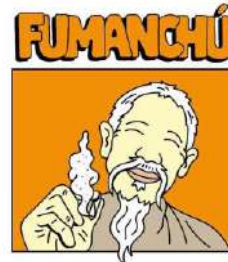

(210) **561228** (540)
(730) **nelson carrasco; UY**
(220) 05/04/2024
(511) **44 (S/D)**
(740) los andes casi av francia, Punta del Este,
20100, Punta del Este, Maldonado, UY

(591) verde y naranja



(210) **561229** (540)

(730) **BARRACA JORGE WALTER ERRO**

S.A.; UY

(220) 05/04/2024

(511) **1 (S/D)**

(740) 34

(591) azul, negro, verde, verde oscuro, verde claro



(210) **561231** (540)

(730) **HEAVEN HILL DISTILLERIES, INC.;**

US

(220) 05/04/2024

(511) **33 (S/D)**

(740) 194

ELIJAH CRAIG

(210) **561232** (540)

(730) **SK BIOPHARMACEUTICALS CO.,**

LTD.; KR

(220) 05/04/2024

(511) **5 (S/D)**

(740) 194

XCOPRI

(210) **561233** (540)
(730) **MGA ENTERTAINMENT, INC.;** US
(220) 05/04/2024
(511) **28 (S/D)**
(740) 212



(210) **561234** (540)
(730) **SAUCONY, INC.;** US
(220) 05/04/2024
(511) **18**
(740) 194



(210) **561236** (540)
(730) **TEROLD EUROPE S.L.;** ES
(220) 05/04/2024
(511) **33 (S/D)**
(740) 94

(591) dorado, gris, celeste



(210) **561237** (540)
(730) **TEROLD EUROPE S.L.**; ES
(220) 05/04/2024
(511) **33 (S/D)**
(740) 94

(591) gris, celeste, blanco, negro, dorado



(210) **561238** (540)
(730) **TEROLD EUROPE S.L.**; ES
(220) 05/04/2024
(511) **33 (S/D)**
(740) 94

(591) negro, rojo, dorado, gris



(210) **561239** (540)
(730) **TEROLD EUROPE S.L.**; ES
(220) 05/04/2024
(511) **33 (S/D)**
(740) 94

(591) negro, blanco, dorado, gris



(210) **561240** (540)
(730) **TEROLD EUROPE S.L.**; ES
(220) 05/04/2024
(511) **33 (S/D)**
(740) 94

(591) negro, gris, blanco, dorado, celeste



(210) **561243** (540)
(730) **LONEMAR S.A.**; UY
(220) 05/04/2024
(511) **35, 36, 37, 39, 41 y 43**
(740) 144

SOLERIOS

(210) **561251** (540)
(730) **SK BIOPHARMACEUTICALS CO., LTD.**; KR
(220) 05/04/2024
(511) **5 (S/D)**
(740) 194

ONTOZRY

(210) **561253** (540)
(730) **JAVIER GONZALEZ LAWLOR; UY**
(220) 08/04/2024
(511) **11 (S/D)**
(740) BUENOS AIRES 375/003, CIUDAD VIEJA,
11000, CIUDAD VIEJA, MONTEVIDEO,
UY

ACQUABLU

(210) **561258** (540)
(730) **MEDEROS RUIZ, MARY ESTHER; UY**
(220) 08/04/2024
(511) **35**
(740) 189

TIENDA JAIME

(210) **561260** (540)
(730) **PADARIA RECANTO COLONIAL
LTDA.; BR**
(220) 08/04/2024
(511) **30**
(740) 189

(591) Azul, rojo, amarillo y blanco



(210) **561273** (540)
(730) **Horacio Pascual**; UY
(220) 08/04/2024
(511) **25 y 41**
(740) 8 de octubre 2355 of 1003, montevideo, ,
montevideo, Montevideo, UY



(210) **561285** (540)
(730) **NOLADRIL S.A.**; UY
(220) 08/04/2024
(511) **9, 36 y 42**
(740) 201

CLING

(210) **561291** (540)
(730) **INGCO TOOLS CO., LIMITED**; CN
(220) 08/04/2024
(511) **6 (S/D), 7 (S/D), 8 (S/D), 9 (S/D), 11 (S/D) y**
20 (S/D)
(740) 144

HOJITA

(210) **561296** (540)
(730) **PREMIER REAL ESTATE SAS; UY**
(220) 08/04/2024
(511) **35 y 37**
(740) 228

(591) Azul y gris



(210) **561303** (540)
(730) **Intel Corporation; US**
(220) 08/04/2024
(511) **9 (S/D) y 42 (S/D)**
(740) 245
(300) 91173 01/12/2023 JM

INTEL TIBER

(210) **561304** (540)
(730) **Intel Corporation; US**
(220) 08/04/2024
(511) **9 (S/D) y 42 (S/D)**
(740) 245
(300) 91174 01/12/2023 JM

TIBER

(210) **561310** (540)
(730) **CONEXIÓN GANADERA LTDA.**; UY
(220) 08/04/2024
(511) **31 y 43**
(740) 94

(591) negro, blanco, marrón



(210) **561311** (540)
(730) **MABLE S.A.**; UY
(220) 08/04/2024
(511) **30**
(740) 94

(591) Marrón, blanco



(210) **561315** (540)
(730) **VITRINOR VITRIFICADOS DEL NORTE, S.A.L.**; ES
(220) 08/04/2024
(511) **21 (S/D)**
(740) 216

(591) Blanco y negro



Frasas Publicitarias Solicitadas

(210) **560634** (540)
(730) **Jimena Peyrou**; UY
(220) 19/03/2024
(511) **36 y 42**
(740) Paysandu 795 Bis A, Montevideo, ,
Montevideo, Montevideo, UY

El valor de la palabra

(210) **560676** (540)
(730) **ESTEBAN AGUIRRE**; UY
(220) 19/03/2024
(511) **25**
(740) 212

**CAMALEÓN, PARA USAR
SEGÚN LA OCASIÓN**

(210) **560677** (540)
(730) **ESTEBAN AGUIRRE**; UY
(220) 19/03/2024
(511) **35**
(740) 212

**CAMALEÓN, PARA COMPRAR
O REGALAR, SEGÚN LA
OCASIÓN**

(210) **560726**
(730) **SOFTYS S.A.**; CL
(220) 20/03/2024
(511) **35 (S/D) y 41 (S/D)**
(740) 221

(540)

Cuidamos el futuro hoy

(210) **560738**
(730) **ALDIESAN S.R.L.**; UY
(220) 20/03/2024
(511) **35**
(740) 254

(540)

**CREATIVIDAD AL ALCANCE
DE SU MANO**

(210) **560740**
(730) **ALDIESAN S.R.L.**; UY
(220) 20/03/2024
(511) **35 y 41**
(740) 254

(540)

**EL ARTE COMO
HERRAMIENTA DE
TRANSFORMACION DE
NOSOTROS MISMOS**

(210) **561125** (540)
(730) **Grupo Bimbo, S.A.B. de C.V.; MX**
(220) 03/04/2024
(511) **29, 30 y 35**
(740) 181

NUTRE LO QUE AMAS

(210) **561235** (540)
(730) **Nelson Carrasco; UY**
(220) 05/04/2024
(511) **44 (S/D)**
(740) los andes casi av francia, Punta del Este,
20100, Punta del Este, Maldonado, UY

PARA SONREIR CON CONFIANZA

CONCESIONES DE MARCAS Y OTROS SIGNOS***Marcas Concedidas***

N° Exp	Resolución	Marca	Clases	Titular	Ag.
483887	05/04/2024	PALMOLIVE (mixta)	3 (Concedida S/D)	COLGATE-PALMOLIVE COMPANY	201
489105	04/04/2024	(tridimensional)	9 (Concedida)	PopSockets LLC	212
507355	03/04/2024	BATERÍAS YA (mixta)	35 (Concedida)	FULVIER S.A.	136
509692	03/04/2024	R. RUSTY (mixta)	14 (Concedida) y 9 (Concedida)	R... and Everything Else, Inc.	
516074	04/04/2024	CONTINENTAL (mixta)	11 (Concedida S/D), 8 (Concedida S/D) y 7 (Concedida S/D)	AB ELECTROLUX	212
518229	03/04/2024	LAND INNOVATION FUND FOR SUSTAINABLE LIVELIHOODS	36 (Concedida S/D)	CARGILL, INC.	201
518640	03/04/2024	ELECTRO FEST MULTI AHORRO HOGAR TA-TA (mixta)	35 (Concedida)	TA-TA S.A.	18
518980	04/04/2024	ANASTASIO BEACH RESORT JOSÉ IGNACIO (mixta)	43 (Concedida)	FIDEICOMISO 53171	194
519808	03/04/2024	FOCUS TALKS	35 (Concedida S/D), 16 (Concedida S/D), 41 (Denegada S/D) y 36 (Denegada S/D)	INVESTEC BANK LIMITED	194
519811	03/04/2024	FOCUS RADIO	35 (Concedida S/D), 16 (Concedida S/D), 41 (Denegada S/D) y 36 (Denegada S/D)	INVESTEC BANK LIMITED	194
521730	02/04/2024	INNOVA CAMPOS & GANADOS (mixta)	36 (Concedida S/D) y 35 (Concedida S/D)	Mauricio Ponte y Américo Pont	144

N° Exp	Resolución	Marca	Clases	Titular	Ag.
522560	04/04/2024	MSL CORPORATE	39 (Concedida S/D)	MARITIME SERVICES LINE URUGUAY SOCIEDAD ANÓNIMA	245
522561	04/04/2024	MM (mixta)	39 (Concedida S/D)	MARITIME SERVICES LINE URUGUAY SOCIEDAD ANÓNIMA	245
522781	04/04/2024	DESTINO SUSHI & WOK (mixta)	43 (Concedida)	DIEGO AGUSTIN BARCA TARIGO	179
523280	04/04/2024	SUPERCOAT	2 (Concedida S/D)	SWIMC LLC	144
527263	05/04/2024	CUANTICA JEANS FOR THE FUTURE (mixta)	25 (Concedida)	Victoria Lorena Guerrero Maciel	
530208	08/04/2024	HANKOOK SMART LINE (mixta)	12 (Concedida S/D)	HANKOOK & COMPANY CO., LTD.	194
530209	08/04/2024	HANKOOK WEATHERFLEX (mixta)	12 (Concedida S/D)	HANKOOK & COMPANY CO., LTD.	194
532255	04/04/2024	SALESFORCE	42 (Concedida), 41 (Concedida) y 9 (Concedida)	SALESFORCE, INC.	201
533924	04/04/2024	ROOSEVELT FOOD PARK (mixta)	43 (Concedida), 35 (Concedida) y 41 (Denegada)	Daniel Sanroman; Luis Taboada; Alejandro Reginensi; Julio Castro y Daniel Balcarcel	21
534993	08/04/2024	TRICHOSHIELD	5 (Concedida) y 1 (Concedida)	RIZOBACTER ARGENTINA S.A.	34
536357	08/04/2024	SOYHOGAR (mixta)	35 (Concedida)	WELAMAN S.A.	216
537542	02/04/2024	VAZ (mixta)	23 (Concedida), 25 (Denegada S/D) y 24 (Denegada S/D)	Sofía Ognjenovich Vaz	205
538541	02/04/2024	O M OTRA MIRADA (mixta)	41 (Concedida) y 38 (Concedida)	MONTE CARLO T.V. S.A.	144
538543	02/04/2024	EL SECUESTRO DE MATEO	41 (Concedida) y 38 (Concedida)	MONTE CARLO T.V. S.A.	144
539805	01/04/2024	1762 1762 DISTILLING FOR 8 GENERATIONS J.J. WHITLEY DISTILLING FOR 8 GENERATIONS DISTILLING FOR 8 GENERATIONS 700ML 3365 54MM LI 02. (mixta)	33 (Concedida S/D)	HALEWOOD INTERNATIONAL BRANDS LIMITED	34

N° Exp	Resolución	Marca	Clases	Titular	Ag.
539865	08/04/2024	MUSEO DE LA CHACRA	41 (Concedida S/D), 38 (Concedida), 35 (Concedida), 25 (Concedida), 21 (Concedida), 20 (Concedida), 19 (Concedida), 18 (Concedida) y 16 (Concedida)	INTENDENCIA MUNICIPAL DE CANELONES	220
540328	03/04/2024	EL ERRANTE	33 (Concedida) y 32 (Denegada)	Pablo Campi	
540624	22/03/2024	SARUBBI VEGANI	29 (Concedida)	Establecimientos Juan Sarubbi S.A.	154
540774	03/04/2024	DEBATE (mixta)	9 (Concedida) y 41 (Denegada)	WOTRAY S.A.	201
540782	05/04/2024	H HYUNDAI (mixta)	7 (Concedida S/D)	Hyundai Motor Company	201
540783	05/04/2024	H HYUNDAI (mixta)	10 (Concedida S/D)	Hyundai Motor Company	201
540793	03/04/2024	VODIX	5 (Concedida)	BALIARDA S.A.	201
542104	08/04/2024	COSECHA NOBLE	33 (Concedida)	REINALDO DE LUCCA GALERATO	129
542105	08/04/2024	DE LUCCA (mixta)	33 (Concedida)	REINALDO DE LUCCA GALERATO	129
542165	08/04/2024	HAUSER (mixta)	42 (Concedida), 37 (Concedida), 36 (Concedida) y 35 (Denegada)	VASWER COMPANY S.A.	189
542224	08/04/2024	HYDRATE (mixta)	20 (Concedida) y 6 (Concedida S/D)	MIPAC SRL	144
542284	08/04/2024	COMPEX	10 (Concedida)	RUMBO ARRUTI, PABLO JAVIER y TORRES, SANDRA	201
542430	08/04/2024	ÁMBAR COSMÉTICA NATURAL (mixta)	5 (Concedida S/D) y 3 (Concedida S/D)	Isis Boetto	
542432	08/04/2024	PURI SNACKS (mixta)	30 (Concedida S/D) y 29 (Concedida)	SOLSIRE S.A.	94

N° Exp	Resolución	Marca	Clases	Titular	Ag.
			S/D)		
542661	08/04/2024	COMUNIDAD CONSCIENTE	44 (Concedida S/D)	Alejandro Cardozo	
542697	08/04/2024	PIETCARD (mixta)	7 (Concedida)	Daniel Antonio Pietrobon	220
542881	08/04/2024	NIKO COCINA FUSIÓN (mixta)	43 (Concedida)	VIGLIARA S.A.	201
542921	08/04/2024	PAGINAS CLASIFICADAS	38 (Concedida), 35 (Concedida) y 16 (Denegada)	PAGINAS AMARILLAS S.A.S.	104
542933	08/04/2024	PURPLE VISTA	34 (Concedida S/D)	Abal Hermanos S.A.	201
542994	08/04/2024	TECTA (mixta)	5 (Concedida)	ZODIAC INTERNATIONAL CORPORATION	245
543033	08/04/2024	MABEE RANCH	36 (Concedida S/D), 30 (Concedida S/D), 25 (Concedida S/D), 21 (Concedida S/D), 18 (Concedida S/D), 16 (Concedida S/D), 11 (Concedida S/D) y 1 (Concedida S/D)	Mabee Ranch, LLC	212
543087	08/04/2024	UNI KA (mixta)	11 (Concedida S/D) y 6 (Concedida)	Fernando Cruz Gonzalez	186
543137	08/04/2024	MAGDALA (mixta)	41 (Concedida S/D)	NEW GATE TO PEACE FOUNDATION	212
543288	08/04/2024	VF (mixta)	41 (Concedida) y 35 (Denegada)	Fernando Abdo	
545371	04/04/2024	R. RUSTY (mixta)	9 (Concedida) y 3 (Concedida)	R... and Everything Else, Inc.	94
547542	08/04/2024	BONFIBRA	5 (Concedida)	EUROFARMA URUGUAY S.A.	201
547736	08/04/2024	CHAMPS ELYSEES	18 (Concedida)	LACOSTE OPERATIONS	212
547737	08/04/2024	CHAMPS ELYSEES	25 (Concedida)	LACOSTE OPERATIONS	212
551259	05/04/2024	ACE (mixta)	45 (Concedida S/D), 41 (Concedida S/D) y 35 (Concedida S/D)	Motion Picture Association, Inc.	194

N° Exp	Resolución	Marca	Clases	Titular	Ag.
553044	08/04/2024	TELEIMPRESORES (mixta)	37 (Concedida) y 35 (Concedida)	TELEIMPRESORES S.A.	253
553388	08/04/2024	H HITS MUSIC UNIVERSAL (mixta)	41 (Concedida S/D) y 9 (Concedida S/D)	Gonzalo Fernández	
554994	01/04/2024	WOLME (mixta)	25 (Concedida S/D)	Julia Pedrozo	
555296	08/04/2024	BIBAGV (mixta)	10 (Concedida S/D) y 5 (Concedida S/D)	FRESENIUS MEDICAL CARE DEUTSCHLAND GMBH	245
555297	08/04/2024	BIBAG (mixta)	10 (Concedida S/D) y 5 (Concedida S/D)	Fresenius Medical Care Deutschland GmbH	245
555399	05/04/2024	MENUCAN	31 (Concedida)	TORRIERI DICONO, RAÚL ALBERTO	189
555408	02/04/2024	(tridimensional)	28 (Concedida)	The KONG Company, LLC	94
555444	02/04/2024	OLYMPISM 365 (mixta)	35 (Concedida S/D)	COMITÉ INTERNATIONAL OLYMPIQUE	201
555573	02/04/2024	MODULWALL BUILD FOREVER (mixta)	40 (Concedida), 39 (Concedida), 37 (Concedida), 20 (Concedida) y 19 (Concedida)	BAWORA S.A.	144
555687	02/04/2024	WELLNESS FACTORY (mixta)	32 (Concedida), 30 (Concedida) y 5 (Concedida)	JUAN ANDRES IZUIBEJERES ALMADA	186
555883	01/04/2024	(tridimensional)	3 (Concedida S/D)	INTERPARFUMS S.A.	144
555884	01/04/2024	FRESH MARKET SELECTION (mixta)	32 (Concedida), 31 (Concedida), 30 (Concedida) y 29 (Concedida)	SUPERMERCADOS DISCO DEL URUGUAY S.A.	144
555986	02/04/2024	OFKU- ORGANIZACION FULL CONTACT KARATE URUGUAY (mixta)	41 (Concedida S/D), 35 (Concedida S/D), 28 (Concedida S/D), 25 (Concedida S/D), 18 (Concedida S/D), 16 (Concedida S/D)	Nelly Saldaña	

N° Exp	Resolución	Marca	Clases	Titular	Ag.
			y 9 (Concedida S/D)		
555991	01/04/2024	FLOW GAME BASKETBALL (mixta)	41 (Concedida S/D) y 25 (Concedida)	Matías Gallo Bevegni	244
555993	08/04/2024	PURA (mixta)	34 (Concedida S/D)	SMISS TECHNOLOGY CO., LTD.	185
556028	08/04/2024	FORMULA B (mixta)	37 (Concedida S/D)	BYD Company Limited	201
556103	09/04/2024	PASCANA QUIOSQUE (mixta)	43 (Concedida)	Germán Martínez	
556115	01/04/2024	LAND CRUISER FJ	12 (Concedida S/D)	TOYOTA JIDOSHA KABUSHIKI KAISHA (also trading as TOYOTA MOTOR CORPORATION)	94
556139	01/04/2024	ISOLE E OLENA	33 (Concedida S/D)	SOCIETA' AGRICOLA ISOLE E OLENA S.R.L.	144
556140	05/04/2024	CEPPARELLO	33 (Concedida S/D)	SOCIETA' AGRICOLA ISOLE E OLENA S.R.L.	144
556160	08/04/2024	UNIVERSAL GENEVE	37 (Concedida S/D), 35 (Concedida S/D), 14 (Concedida S/D) y 9 (Concedida S/D)	UNIVERSAL GENEVE SA	181
556174	01/04/2024	ROYAL BRONZE (mixta)	3 (Concedida S/D)	BIOCOSMETICA EXEL ARGENTINA S.R.L.	219
556195	08/04/2024	SEQUÍA EXTREMA	33 (Concedida)	GIMENEZ MENDEZ S.R.L.	220
556286	02/04/2024	ASTIK SR	5 (Concedida S/D)	LUMINOVA PHARMA CORPORATION GmbH	212
556309	09/04/2024	CONFLUENZA	33 (Concedida)	COOPERATIVA AGRARIA DE VITICULTORES ASOCIADOS DE RESPONSABILIDAD LIMITADA	201
556409	01/04/2024	CONCURSO DE QUESOS DEL URUGUAY (mixta)	41 (Concedida S/D) y 29 (Concedida S/D)	AGENCIA DE DESARROLLO ECONOMICO DEL ESTE DE COLONIA	220
556414	01/04/2024	TRAVESURAS	31 (Concedida S/D)	Société des Produits Nestlé S.A.	212
556421	01/04/2024	GABBY'S DOLLHOUSE	41 (Concedida) y 28 (Concedida S/D)	DreamWorks Animation L.L.C.	94
556449	05/04/2024	ATLHETICA NUTRITION	5 (Concedida S/D)	ADS Laboratório Nutricional LTDA EPP	34
556465	01/04/2024	MY ONLINE SCHOOLING (mixta)	41 (Concedida S/D), 16 (Concedida S/D) y 9 (Concedida S/D)	WEY EDUCATION SERVICES LIMITED	179

N° Exp	Resolución	Marca	Clases	Titular	Ag.
556474	01/04/2024	SUNVIVE	3 (Concedida S/D)	UAS PHARMACEUTICALS PTY LTD.	189
556476	02/04/2024	ALTOS LIFE ELEVANDO TU BIENESTAR (mixta)	43 (Concedida)	ALAMERICA S A	220
556482	01/04/2024	BE11	12 (Concedida S/D)	Skywell New Energy Vehicles Group Co., Ltd.	144
556484	01/04/2024	(figurativa)	12 (Concedida S/D)	TOYOTA JIDOSHA KABUSHIKI KAISHA (also trading as TOYOTA MOTOR CORPORATION)	94
556488	01/04/2024	NATURAL LIFE (mixta)	35 (Concedida)	LAKINOR S.A.	34
556489	02/04/2024	DIVERSA BY VALENTINA RABAJDA (mixta)	25 (Concedida)	Valentina Daniela Rabajda Arias	212
556490	01/04/2024	DIVERSA BY VALENTINA RABAJDA (mixta)	35 (Concedida)	Valentina Daniela Rabajda Arias	212
556491	01/04/2024	BALANCE WITHIN	5 (Concedida S/D)	ALTICOR INC	34
556492	01/04/2024	FIUME	25 (Concedida)	Marty, Hernan Jesus	94
556495	01/04/2024	BIOSOME6	3 (Concedida S/D)	Jurlique International Pty Ltd	201
556497	01/04/2024	DALE PLAY	28 (Concedida)	SPAGNUOLO, OSCAR	189
556499	02/04/2024	AHORRA FÁCIL (mixta)	42 (Concedida S/D), 35 (Concedida S/D) y 9 (Concedida S/D)	Ahorrafacil SAS	
556518	01/04/2024	W WERTULY INTERNATIONAL S.A. (mixta)	41 (Concedida S/D) y 36 (Concedida S/D)	Trading Point Holdings Ltd	179
556525	05/04/2024	LUO	10 (Concedida S/D) y 5 (Concedida S/D)	Jagotec AG	201
556555	09/04/2024	ACADEMIA MONTES DEL PLATA (mixta)	44 (Concedida), 42 (Concedida), 41 (Concedida), 40 (Concedida), 39 (Concedida), 37 (Concedida), 35 (Concedida), 31 (Concedida)	EUFORES S.A.	34

N° Exp	Resolución	Marca	Clases	Titular	Ag.
			(Concedida), 19 (Concedida), 17 (Concedida), 16 (Concedida) y 1 (Concedida)		
556567	02/04/2024	CT FASER (mixta)	19 (Concedida) y 11 (Concedida)	DINAFIL SA	
556568	02/04/2024	BYD KING	12 (Concedida S/D)	BYD Company Limited	201
556588	09/04/2024	MPASTO START	31 (Concedida S/D), 5 (Concedida S/D) y 1 (Concedida S/D)	Mosaic Fertilizantes do Brasil Ltda	216
556598	05/04/2024	PAKTEK (mixta)	35 (Concedida S/D), 17 (Concedida S/D) y 1 (Concedida S/D)	Emasal Uruguay SAS	235
556600	02/04/2024	PUNKTAL PRICE CLUB	36 (Concedida) y 35 (Concedida)	PUNKTAL S.A.	189
556603	02/04/2024	K KREILABS (mixta)	42 (Concedida S/D)	Kreilabs SAS	
556607	02/04/2024	M&G SHOP (mixta)	35 (Concedida S/D) y 16 (Concedida S/D)	SHANGHAI M&G STATIONERY INC.	201
556609	01/04/2024	(figurativa)	10 (Concedida S/D) y 5 (Concedida S/D)	Jagotec AG	201
556611	01/04/2024	ILUMA ONE	34 (Concedida S/D)	Philip Morris Products S.A.	201
556612	01/04/2024	ILUMA PRIME	34 (Concedida S/D)	Philip Morris Products S.A.	201
556614	09/04/2024	SMARTCORE	34 (Concedida S/D)	Philip Morris Products S.A.	201
556617	09/04/2024	EDELMEISTER	32 (Concedida S/D)	Van Pur S.A.	201
556622	09/04/2024	BAFRY (mixta)	1 (Concedida S/D)	ACSAN S.A.S.	194
556623	09/04/2024	BAFRY (mixta)	5 (Concedida)	ACSAN S.A.S.	194
556700	01/04/2024	HEALING HANDS	25 (Concedida S/D) y 10 (Concedida S/D)	Krazy Kat Sportswear, LLC	144

N° Exp	Resolución	Marca	Clases	Titular	Ag.
556701	08/04/2024	CALI PODS (mixta)	34 (Concedida S/D)	Cali Trade Group LLC	144
556729	09/04/2024	FREECAT	31 (Concedida S/D)	Mohamed Montassar Ben Deya	
556730	09/04/2024	FREEDOG	31 (Concedida S/D)	Mohamed Montassar Ben Deya	
556749	01/04/2024	XANAPIE (mixta)	3 (Concedida)	FELIPE MARIÑANSKY	129
556750	01/04/2024	TODOFRONTERA	29 (Concedida)	FIANELLO S.A.	
556754	01/04/2024	ORILLA (mixta)	36 (Concedida)	ALVARO MIGUEL CAYOL; PABLO REYNAL y Francisco Pablo Reynal	186
556755	01/04/2024	CEMTEC	35 (Concedida S/D)	CEMTEC S.A.S.	179
556759	01/04/2024	ZONA BROKERS (mixta)	36 (Concedida)	Maria Noel Deamestoy	216
556760	01/04/2024	ROADMAP TO ZERO ZDHC (mixta)	42 (Concedida S/D), 41 (Concedida S/D), 40 (Concedida S/D) y 35 (Concedida S/D)	Stichting ZDHC Foundation	247
556761	01/04/2024	ZDHC (mixta)	42 (Concedida S/D), 41 (Concedida S/D), 40 (Concedida S/D) y 35 (Concedida S/D)	Stichting ZDHC Foundation	247
556765	01/04/2024	REVOTECH	42 (Concedida S/D), 35 (Concedida S/D) y 9 (Concedida S/D)	REVOTECH SINGLE MEMBER P.C.	216
556768	01/04/2024	DURIT (mixta)	6 (Concedida S/D)	DURIT - METALURGIA PORTUGUESA DO TUNGSTENIO, LDA.	247
556770	01/04/2024	QUILMES	43 (Concedida), 41 (Concedida), 39 (Concedida), 38 (Concedida), 36 (Concedida) y 35 (Concedida)	CERVECERIA Y MALTERIA QUILMES S.A.I.C.A.G.	144
556774	01/04/2024	MATERMAP (mixta)	9 (Concedida S/D)	María Dolores Rodríguez Blanco	144

N° Exp	Resolución	Marca	Clases	Titular	Ag.
556775	01/04/2024	(figurativa)	16 (Concedida S/D) y 2 (Concedida S/D)	Seiko Epson Kabushiki Kaisha (also trading as Seiko Epson Corporation)	144
556776	01/04/2024	(figurativa)	16 (Concedida S/D) y 2 (Concedida S/D)	Seiko Epson Kabushiki Kaisha (also trading as Seiko Epson Corporation)	144
556777	01/04/2024	(figurativa)	16 (Concedida S/D) y 2 (Concedida S/D)	Seiko Epson Kabushiki Kaisha (also trading as Seiko Epson Corporation)	144
556778	01/04/2024	(figurativa)	16 (Concedida S/D) y 2 (Concedida S/D)	Seiko Epson Kabushiki Kaisha (also trading as Seiko Epson Corporation)	144
556779	01/04/2024	VILLA DOMUS	43 (Concedida) y 41 (Concedida)	Sandra Candales Arca	144
556783	08/04/2024	LA TANA MILONGA (mixta)	41 (Concedida)	Andrés Deus	
556785	01/04/2024	(figurativa)	9 (Concedida S/D)	Kia Corporation	201
556791	01/04/2024	(figurativa)	12 (Concedida S/D)	Kia Corporation	201
556794	01/04/2024	(figurativa)	25 (Concedida S/D)	Kia Corporation	201
556795	01/04/2024	HAKKO FERMENTACIÓN NATURAL (mixta)	30 (Concedida S/D)	Andrea Billar	
556798	08/04/2024	ROBUSTA CAFÉ TAKE AWAY (mixta)	43 (Concedida S/D)	GONZALO CENTURION y MARIA MONTSERRAT SANCHEZ	
556799	01/04/2024	GAMMA GE (mixta)	42 (Concedida) y 9 (Concedida S/D)	Barla y Malan Asociados S.R.L.	216
556801	01/04/2024	GAMMA GE (mixta)	42 (Concedida) y 9 (Concedida S/D)	Barla y Malan Asociados S.R.L.	216
556802	01/04/2024	FORESTERRA (mixta)	44 (Concedida)	BUNTIL S.A.	34
556803	05/04/2024	AFFECTIVE LIBERTY (mixta)	5 (Concedida S/D) y 3 (Concedida S/D)	GRUPO P.I. MABE, S.A. DE C.V.	218
556804	01/04/2024	MR AUTOMOVILES	37 (Concedida), 36 (Concedida) y 35 (Concedida)	Denis Michel Rodriguez Hernández	174
556806	05/04/2024	DR. TRANSITO	45 (Concedida)	JAVIER RIFFAUD	94
556807	01/04/2024	LAS OPHELIAS	41 (Concedida)	Lara Berman	212
556809	05/04/2024	ZENIUS	11 (Concedida S/D)	Société des Produits Nestlé S.A.	212

N° Exp	Resolución	Marca	Clases	Titular	Ag.
556810	08/04/2024	LATISSIMA	11 (Concedida S/D)	Société des Produits Nestlé S.A.	212
556812	09/04/2024	SULGEN	5 (Concedida S/D)	Roxall Medizin GmbH	245
556813	09/04/2024	CLUSTOID	5 (Concedida S/D)	Roxall Medizin GmbH	245
556815	08/04/2024	AGUILA	11 (Concedida S/D)	Société des Produits Nestlé S.A.	212
556816	08/04/2024	AEROCCINO	11 (Concedida S/D)	Société des Produits Nestlé S.A.	212
556817	08/04/2024	CITIZ	11 (Concedida S/D)	Société des Produits Nestlé S.A.	212
556818	08/04/2024	PIXIE	11 (Concedida S/D)	Société des Produits Nestlé S.A.	212
556819	08/04/2024	POCO LOCO (mixta)	30 (Concedida)	GUEMIPER SRL	181
556828	09/04/2024	LCHSE (mixta)	9 (Concedida S/D)	JIANGXI LIANCHUANG HONGSHENG ELECTRONIC CO. LTD.	189
556900	05/04/2024	AUNLAIR	5 (Concedida S/D)	NEILOS SRL	201
556901	05/04/2024	RYDANZ (mixta)	12 (Concedida S/D)	QINGDAO RYDANZ INTERNATIONAL TRADING CO., LTD.	34
556902	05/04/2024	BAMBÚ (mixta)	41 (Concedida S/D)	Carolina Andrade	
556903	08/04/2024	VISUAR (mixta)	39 (Concedida), 35 (Concedida), 11 (Concedida), 9 (Concedida) y 1 (Concedida)	VISUAR S.A.	34
556905	08/04/2024	ROYAL JOYERIA (mixta)	35 (Concedida) y 14 (Concedida)	HENDERSON & CIA. S.A.	181
556906	05/04/2024	XTC (mixta)	9 (Concedida), 7 (Concedida), 6 (Concedida) y 1 (Concedida)	Xiamen Tungsten Co., Ltd.	34
556908	08/04/2024	SCHWEPPE TÓNICA ROSÉ 1783 (mixta)	32 (Concedida)	EUROPEAN REFRESHMENTS UNLIMITED COMPANY	94
556910	08/04/2024	212 (mixta)	12 (Concedida S/D)	Beijing Automobile Works Co., Ltd	34
556911	09/04/2024	TIENDA ROYAL JOYERIA (mixta)	35 (Concedida) y 14 (Concedida)	HENDERSON & CIA. S.A.	181
556912	08/04/2024	BAW (mixta)	12 (Concedida S/D)	Beijing Automobile Works Co., Ltd	34

N° Exp	Resolución	Marca	Clases	Titular	Ag.
556913	09/04/2024	TIENDA ROYAL JOYERIA (mixta)	35 (Concedida) y 14 (Concedida)	HENDERSON & CIA. S.A	181
556914	08/04/2024	ALFAMANIA	30 (Concedida)	EDANREY S.A.	181
556915	09/04/2024	RICAO	30 (Concedida)	EDANREY S.A.	181
556917	09/04/2024	RICARDIQUISIMO	30 (Concedida)	EDANREY S.A.	181
556918	09/04/2024	HADAS Y DUENDES	35 (Concedida S/D) y 25 (Concedida S/D)	LETICIA MARCENARO	
556926	09/04/2024	HYDRONORTH (mixta)	2 (Concedida S/D)	HYDRONORTH S.A.	201
556929	09/04/2024	WETHERBY	41 (Concedida S/D), 25 (Concedida S/D), 16 (Concedida S/D) y 9 (Concedida S/D)	Alpha Plus Group Ltd	179
556931	09/04/2024	FOENZA (mixta)	35 (Concedida) y 11 (Concedida)	PIÑEYRO RADO, MAURO LUIS	201
556932	09/04/2024	NETCANN	5 (Concedida) y 3 (Concedida)	ANTIRES S.A.	201
557001	02/04/2024	SEAKNIT (mixta)	25 (Concedida S/D)	Grundéns Regnkläder AB	245
557002	01/04/2024	(figurativa)	25 (Concedida S/D) y 9 (Concedida S/D)	Grundéns Regnkläder AB	245
557008	02/04/2024	TOMATE TECNOLOGIA Y ACCESORIOS (mixta)	9 (Concedida S/D)	JAKANNEY S.A.	220
557009	02/04/2024	TOMATE TECNOLOGIA Y ACCESORIOS (mixta)	35 (Concedida S/D)	JAKANNEY S.A.	220
557010	02/04/2024	TOMATE TECNOLOGIA Y ACCESORIOS (mixta)	37 (Concedida)	JAKANNEY S.A.	220
557019	05/04/2024	EXACTLY PROTOCOL (mixta)	42 (Concedida S/D), 36 (Concedida S/D) y 9 (Concedida S/D)	EXAFIN LTD.	179
557025	05/04/2024	WS (mixta)	41 (Concedida S/D), 25 (Concedida S/D),	Alpha Plus Group Ltd	179

N° Exp	Resolución	Marca	Clases	Titular	Ag.
			16 (Concedida S/D) y 9 (Concedida S/D)		
557029	08/04/2024	AGRI DIS	5 (Concedida S/D) y 1 (Concedida S/D)	SERVICIOS TECNICOS DE CANARIAS, SL	144
557030	08/04/2024	TERRA DIS	5 (Concedida S/D) y 1 (Concedida S/D)	SERVICIOS TECNICOS DE CANARIAS, SL	144
557031	08/04/2024	CLODOS PURO	5 (Concedida S/D) y 1 (Concedida S/D)	SERVICIOS TECNICOS DE CANARIAS, SL	144
557034	08/04/2024	NATASHA DENONA	35 (Concedida S/D) y 3 (Concedida S/D)	NATASHA DENONA TRADING LIMITED	212
557036	08/04/2024	RUMAH STUDIO HOME DESIGN (mixta)	42 (Concedida S/D), 35 (Concedida) y 20 (Concedida)	RUMAH STUDIO SAS	186
557042	08/04/2024	ITOVEBI	5 (Concedida S/D)	F. Hoffmann-La Roche AG	201
557054	09/04/2024	NEETA	3 (Concedida S/D)	HANSRAJ NEMARAM GEHLOT y NARPATLAL NEMARAM GEHLOT	245
557055	09/04/2024	YUTHIKA	3 (Concedida S/D)	JETHARAM NEMARAM GEHLOT	245
557057	09/04/2024	H&G HOME (mixta)	27 (Concedida), 24 (Concedida), 21 (Concedida) y 20 (Concedida)	TA-TA S.A.	245

Frasas Publicitarias Concedidas

N° Exp	Resolución	Marca	Clases	Titular	Ag.
556923	09/04/2024	Las telas son el lenguaje del alma	35 (Concedida) y 24 (Concedida)	GABRIELA FERNANDEZ	252
556930	09/04/2024	Todo lo que te mueve en un solo lugar	45 (Concedida), 43 (Concedida), 41 (Concedida), 39	SANTA ROSA AUTOMOTORES SA	

N° Exp	Resolución	Marca	Clases	Titular	Ag.
			(Concedida), 38 (Concedida), 36 (Concedida), 35 (Concedida) y 12 (Concedida)		

DESISTIMIENTOS DE MARCAS Y OTROS SIGNOS***Marcas Desistidas (Art. 90 D. 34/999)***

N° Exp	Resolución	Marca	Clases	Titular	Ag.
556483	01/04/2024	ET5	12 (Desistida S/D)	Skywell New Energy Vehicles Group Co., Ltd.	144
556762	08/04/2024	KLAIN	30 (Desistida)	MULTIMARCAS UY SAS	
556885	02/04/2024	T TECHNIC COSMETICS (mixta)	3 (Desistida)	ERNESTO JUAN SCHAURICHT LAFRANCHI	144
556886	02/04/2024	W7 COSMETICS (mixta)	3 (Desistida)	ERNESTO JUAN SCHAURICHT LAFRANCHI	144
556970	09/04/2024	Executor of 3D Projects (mixta)	42 (Desistida), 40 (Desistida) y 35 (Desistida)	Gonzalo Javier Silveira Nerón y Rocio Syomara Silveira Nerón	105
556981	05/04/2024	CLASH	14 (Desistida)	CARTIER INTERNATIONAL AG	144
557003	01/04/2024	GOL X GOL MUNDIAL	41 (Desistida S/D)	Fox Media LLC	245
557113	09/04/2024	ATRIX (mixta)	35 (Desistida S/D)	ATRIX URUGUAY SAS	
557501	09/04/2024	SAL DEL ESTE	30 (Desistida)	AFGERY COMPANY S.A.	34
558351	09/04/2024	300V (mixta)	4 (Desistida S/D) y 1 (Desistida S/D)	MOTUL	144
560111	09/04/2024	Leruleru (mixta)	35 (Desistida) y 25 (Desistida)	ARKUUS SAS ARKUUS SAS y Fernando Madriaga	
560411	09/04/2024	LION ROLLING CIRCUS R (mixta)	34 (Desistida S/D)	Diego Anibal Vega Cousté	
560909	09/04/2024	TORALGIN	5 (Desistida)	LABORATORIOS DE PRODUCTOS ETICOS S.A.	201

Renovaciones de Marcas Desistidas (Art. 90 D. 34/999)

N° Exp	Resolución	Marca	Clases	Titular	Ag.
556221	09/04/2024	VAXIGRIP TETRA	5 (Desistida S/D)	SANOFI PASTEUR	144
556569	09/04/2024	TORRELOBOS MI PARAISO (mixta)	37 (Desistida) y 36 (Desistida)	EDIFICIO TORRELOBOS	94
557706	09/04/2024	MAPEX	3 (Desistida S/D)	MOLINO ASUNCENO ALBERTO	201

N° Exp	Resolución	Marca	Clases	Titular	Ag.
				HEILBRUNN S.A.	
560772	09/04/2024	COCINA DE PUNTA DEL ESTE LO DE TERE CASA DE GRANDES VINOS (mixta)	43 (Desistida S/D), 29 (Desistida) y 25 (Desistida)	MARIA EUGENIA MARFETAN CURBELO	244

DESESTIMACIONES DE MARCAS Y OTROS SIGNOS***Marcas Desestimadas***

N° Exp	Resolución	Marca	Clases	Titular	Ag.
501213	02/04/2024	VATIO	9 (Denegada S/D)	BAUQUE S.A.	144
501214	03/04/2024	VATIO	35 (Denegada S/D)	BAUQUE S.A.	144
510797	04/04/2024	BIO-ARGIN	3 (Denegada S/D)	COLGATE-PALMOLIVE COMPANY	201
511051	04/04/2024	TORO RANCH (mixta)	12 (Denegada S/D)	FCA FIAT CHRYSLER AUTOMÓVEIS BRASIL LTDA.	144
515013	04/04/2024	AKTIVPLUS	5 (Denegada S/D)	NORTESUR S.A.	192
521780	02/04/2024	FORTE (mixta)	25 (Denegada)	HERNANDEZ RODRIGUEZ ELBA MARIELA UNIPERSONAL	220
521814	02/04/2024	REBEL	12 (Denegada S/D)	AUDINAL S A	144
521829	02/04/2024	DELOTTO (mixta)	25 (Denegada)	DENTERA S.A.	220
521866	02/04/2024	NI-PON (mixta)	12 (Denegada S/D)	ZHONGCE RUBBER GROUP COMPANY LIMITED	34
523056	04/04/2024	STERIWASH (mixta)	3 (Denegada S/D)	Nuqul Brothers Company Limited	212
538240	02/04/2024	YAPA	41 (Denegada S/D)	Roberto Fernández	
538688	02/04/2024	METABOX (mixta)	9 (Denegada)	Valfey Company S.A.	212
538690	02/04/2024	METABOX (mixta)	35 (Denegada)	Valfey Company S.A.	212
539933	08/04/2024	INCODE OMNI	42 (Denegada S/D) y 9 (Denegada S/D)	INCODE TECHNOLOGIES INC. (UNA CORPORACIÓN DE DELAWARE, USA)	212
540843	03/04/2024	ORTIZ FISCHER (mixta)	6 (Denegada S/D)	LIFTEC S.A.	
542400	08/04/2024	LUMBERJACK (mixta)	25 (Denegada S/D)	FLO MAGAZACILIK VE PAZARLAMA ANONIM SIRKETI	216
542484	08/04/2024	INSTA360 (mixta)	9 (Denegada S/D)	ARASHI VISION INC.	34
542927	08/04/2024	CANELONES TED ALIMENTA (mixta)	41 (Denegada), 38 (Denegada) y 35 (Denegada)	ANDRES GALLO DUBOURG	220

N° Exp	Resolución	Marca	Clases	Titular	Ag.
542992	08/04/2024	ARRABAL (mixta)	30 (Denegada S/D)	Mateo Miraglia	144
543398	08/04/2024	MONTENEVI	29 (Denegada)	MAS NUTRICION S.A.	241
543401	08/04/2024	COLTIX	5 (Denegada)	Szabo S.A.	212

Marcas Desestimadas (Art. 92 D. 34/999)

N° Exp	Resolución	Marca	Clases	Titular	Ag.
553815	02/04/2024	TATÚ (mixta)	42 (Denegada S/D)	Dandenon SRL	

Renovaciones de Marcas Desestimadas (Art. 92 D. 34/999)

N° Exp	Resolución	Marca	Clases	Titular	Ag.
500668	02/04/2024	CHAMPION INCAL	25 (Concedida S/D) y 18 (Concedida S/D)	CORALPLUS S.A.	189
552632	08/04/2024	RISEDRON	5 (Denegada)	Gramón Bagó de Uruguay S.A.	181

Renovaciones de Marcas Desestimadas (Art. 92 D. 34/999)

N° Exp	Resolución	Marca	Clases	Titular	Ag.
551053	01/04/2024	FLASH POWER	32 (Denegada S/D)	FLASH POWER DO BRASIL S/C LTDA	34

Marcas Tenidas por Desistidas (Art. 92 D. 34/999)

N° Exp	Resolución	Marca	Clases	Titular	Ag.
542833	08/04/2024	MORINGA ORGÁNICA (mixta)	25 (Desistida S/D)	MONTAÑA STÜGELMAYER KELLY JUDITH	
544812	02/04/2024	FIXUP! (mixta)	37 (Desistida S/D)	Jesús Alewaerts Bravetti	
549309	02/04/2024	MOL MODA & CONCIENCIA (mixta)	25 (Desistida S/D)	Marcela Alejandra Cousillas Mieres	
553481	05/04/2024	LA MANZANITA REPARACIÓN Y VENTA DE CELULARES (mixta)	9 (Desistida S/D)	GORTAIRE CADENA DIEGO JAVIER, ALVAREZ CADENA EDELVIS MONICA Y OTROS SOCIEDAD DE HECHO	

MODIFICACION DE RESOLUCIONES***Marcas con Resolución Modificada***

N° Exp	Resolución	Marca	Clases	Notas	Ag.
502841	02/04/2024	CLARIOS / CPS Technology Holdings LLC	37 (Concedida S/D) y 9 (Denegada S/D)		194
514173	04/04/2024	PIK / Panificadora Bimbo del Uruguay S.A.	30 (Pendiente)		
546667	02/04/2024	JUPITER / JUPITER COMPANY S.A.	21 (Concedida)		201
553414	04/04/2024	PRIME (mixta) / AMAZON TECHNOLOGIES, INC.	42 (Concedida S/D), 41 (Concedida S/D), 39 (Concedida S/D), 38 (Concedida S/D), 35 (Concedida S/D), 16 (Concedida S/D) y 9 (Concedida S/D)		181

Frases Publicitarias con Resolución Modificada

N° Exp	Resolución	Marca	Clases	Notas	Ag.
516861	03/04/2024	CONSTRUYENDO CONFIANZA / SIKA AG.	19 (Concedida), 17 (Concedida) y 1 (Concedida)		201

NOTIFICACION DE RESOLUCIONES

Se notifican las siguientes resoluciones, de conformidad con lo establecido por el numeral 4º del artículo 80 de la Ley 17.011 del 25 de setiembre de 1998 (el cual indica: *Créase el Boletín de la Propiedad Industrial, en el que se publicarán ... Las notificaciones que, debiendo realizarse personalmente, no pudieran cumplirse por causa imputable al gestionante, salvo lo previsto en el artículo 317 de la Constitución de la República*), y por el artículo 87 del decreto N° 34/999 del 3 de febrero de 1999 (el cual indica: *Las notificaciones que debiendo realizarse personalmente no pudieran cumplirse por causa imputable al gestionante se realizarán en el Boletín de la Propiedad Industrial, considerándose notificación suficiente la no comparecencia del interesado vencidos los tres días hábiles siguientes al de su publicación*).

MARCA	SIGNATURE
ACTA	439670
NOMBRE	BOIGUE S.A
NOTIFICACION	<p>Documento: Anulación Nro. MA/ 2023/ 005568 Expediente: Marca Nro. 439670 Signo: SIGNATURE (mixta) Titular: BOIGUE S.A. Clase(s): 9, 35, 38 y 42</p> <p>Ponemos de su conocimiento que, del estudio formal del documento de referencia, surgen las siguientes observaciones: Dispónese la apertura a prueba de estas actuaciones, por el término de 60 días perentorios e improrrogables, debiendo tenerse presente lo dispuesto por el Art. 82 del Decreto Reglamentario N° 34/999.</p>

MARCA	BRANDS FOR LESS
ACTA	478264
NOMBRE	BRANDS FOR LESS S/A
NOTIFICACION	<p>Expediente: Marca Nro. 478264 Signo: BRANDS FOR LESS (mixta) Titular: BRANDS FOR LESS S/A Clase(s): 35</p> <p style="text-align: right;">Montevideo, 22 de marzo de 2024</p> <p>De acuerdo con el dictamen previo de la División Recursos y otras Acciones se confiere vista a las partes por el término de diez días hábiles, perentorios e improrrogables, conforme artículo 16 del Decreto 34/999 del 3/2/999. De acuerdo a lo que surge de estas actuaciones y dado que la firma BRANDS FOR LESS S/A no tiene domicilio en Uruguay, la notificación deberá realizarse mediante publicación en el Boletín de la Propiedad Industrial.</p>
MARCA	CIMARRON
ACTA	427697
NOMBRE	IGNACIO CAMBRE GONZALEZ
NOTIFICACION	<p>Expediente: Marca Nro. 427697 Signo: CIMARRON Titular: IGNACIO CAMBRE GONZALEZ Clase(s): 41</p> <p style="text-align: right;">Montevideo, 6 de marzo de 2024</p> <p>De acuerdo con el dictamen de la División Recursos y otras Acciones del día de la fecha, y previo a dictamen final, se confiere vista de lo actuado por el término de diez días hábiles, perentorios e improrrogables, conforme artículo 16 del Decreto 34/999 del 3/2/999.</p>

CANCELACION POR FALTA DE USO DE MARCAS Y OTROS SIGNOS***Marcas Canceladas por Falta de Uso***

N° Exp	Resolución	Marca	Clases	Notas	Ag.
447917	02/04/2024	BONFIBRA	30 (Concedida) y 5 (Concedida)	THE LATIN AMERICA TRADEMARK CORPORATION	144
473973	02/04/2024	CHAMPS ELYSEES	25 (Concedida) y 18 (Concedida)	Stefano Fagian	101

Renovaciones de Marca Canceladas por Falta de Uso

N° Exp	Resolución	Marca	Clases	Notas	Ag.
460965	08/04/2024	PULOIL REFLEX	3 (Concedida)	COLGATE-PALMOLIVE ARGENTINA S.A.	180

RENOVACIONES DE MARCAS Y OTROS SIGNOS***Marcas Renovadas***

N° Exp	Resolución	Denominación	Clases	Titular	Vigencia	Ag.
495857	22/03/2024	CLUB BIGUA (mixta)	16, 28 y 41	CLUB BIGUA DE VILLA BIARRITZ	15/06/2018	
539398	03/04/2024	POLAROID	1 (S/D), 9 (S/D) y 16 (S/D)	Polaroid IP B.V.	14/07/2022	216
542652	22/03/2024	AVANTI	29 y 31	LABREZZA S.A.	23/11/2022	144
544603	03/04/2024	GLIFOPOINT	5	POINT AMERICAS S.A.	12/11/2022	129
546217	22/03/2024	VICTORY MOTORCYCLES USA (mixta)	12 (S/D)	AUTECO MOBILITY S.A.S.	04/01/2023	216
546995	22/03/2024	SERESTO	5 (S/D)	Elanco Animal Health GmbH	09/08/2022	192
547083	22/03/2024	ZIDOMUV	5	LABORATORIO LKM S.A.	30/01/2023	167
547184	03/04/2024	IBEC	41	A y C DIGITAL S.R.L.	30/07/2023	189
547367	01/04/2024	PWC (mixta)	35 (S/D) y 36 (S/D)	PWC BUSINESS TRUST	02/04/2023	245
547457	01/04/2024	(figurativa)	9, 38, 40, 41 y 42	APPLE INC.	17/05/2023	245
547580	01/04/2024	MOBIL	4 (S/D)	Exxon Mobil Corporation	12/08/2023	136
547581	01/04/2024	MOBIL	4 (S/D)	Exxon Mobil Corporation	12/08/2023	136
547620	03/04/2024	MANOLETE (mixta)	29 (S/D)	COMPANIA OLEAGINOSA URUGUAYA S.A.	23/04/2023	144
547777	01/04/2024	MARINA DE BOURBON	3 (S/D)	ZYLANGIA	25/02/2023	144
548223	08/04/2024	SIGALO A VARELA	35 y 36	VARELA INMOBILIARIA SRL	30/05/2023	
548314	02/04/2024	ESLABON DE LUJO (mixta)	7 (S/D) y 11 (S/D)	WHIRLPOOL ARGENTINA S.R.L.	24/06/2023	212
548376	02/04/2024	PDI (mixta)	3 (S/D) y 5 (S/D)	PROFESSIONAL DISPOSABLES INTERNATIONAL, INC.	12/06/2023	212
548491	13/03/2024	PURACEPA (mixta)	30 (S/D)	COMPANIA OLEAGINOSA URUGUAYA S.A.	12/05/2023	144
548493	22/03/2024	SIBARITA (mixta)	29 (S/D)	COMPANIA OLEAGINOSA URUGUAYA S.A.	12/05/2023	144

N° Exp	Resolución	Denominación	Clases	Titular	Vigencia	Ag.
548511	22/03/2024	TRACRIUM	5 (S/D)	Aspen Global Incorporated	19/05/2023	201
548540	01/04/2024	LO DE SILVERIO (mixta)	43	Martin Duarte	22/05/2023	
548595	13/03/2024	FORTUM	5 (S/D)	SANDOZ AG	16/09/2023	201
548612	14/03/2024	ISO	42	INSTITUTO URUGUAYO DE NORMAS TÉCNICAS	17/03/2023	154
548686	14/03/2024	AIRE Y SOL	35	SERGIO FREITAS COLLAZO	09/09/2023	194
548823	14/03/2024	DEPRECALM	5	LAZAR S.A.	14/07/2023	165
548824	14/03/2024	DUXTRA	5	LAZAR S.A.	21/08/2023	165
549005	01/04/2024	HI-PHASE	1 (S/D)	SOLENI TECHNOLOGIES CAYMAN, L.P.	04/06/2023	194
549037	02/04/2024	ADFEN DOL	5 (S/D)	LABORATORIO MAVER S.A.	16/05/2023	201
549122	08/04/2024	PIMACO	16	AUTO ADESIVOS PARANÁ S.A.	30/04/2023	34
549362	02/04/2024	CARRERA	28 (S/D)	Stadelbauer Marketing + Vertireb GMBH	14/04/2023	104
549509	01/04/2024	KEEP YACHTING	35 y 41	Javier Santome	17/04/2023	
549599	01/04/2024	DISCO CONTIGO TODOS LOS DÍAS	16 y 35	SUPERMERCADOS DISCO DEL URUGUAY S.A.	13/08/2023	144
549601	03/04/2024	KELVINATOR (mixta)	11 (S/D)	ELECTROLUX HOME PRODUCTS, INC.	01/06/2023	201
549637	01/04/2024	CASILLERO DEL DIABLO	33 (S/D)	VIÑA CONCHA Y TORO S.A.	27/06/2023	144
549838	22/03/2024	RACIONALISMO CRISTÃO (mixta)	41 (S/D)	CENTRO REDENTOR	05/06/2023	34
549842	01/04/2024	DOCTOR PIES	3 y 5	SIGI S.A.	02/06/2023	212
549847	01/04/2024	VIXORFIT	5	SIGI S.A.	07/07/2023	212
549976	14/03/2024	SUREPAL	5 (S/D) y 10 (S/D)	SANDOZ AG	30/10/2023	144
550012	14/03/2024	CARBEMOX	5	LABORATORIO GADOR S.A.	11/06/2023	165
550013	14/03/2024	HERMEX	6 (S/D)	TRUPER, S.A. DE C.V.	15/05/2023	144
550015	14/03/2024	SKINSUN	3 y 5	ELECTRON S.A.	16/05/2023	144
550016	14/03/2024	CACIQUE	29 (S/D), 30 (S/D), 31 (S/D) y 32 (S/D)	ACEITERAS DEL URUGUAY Y CIDAC UNIDAS S.A.	30/06/2023	144
550017	14/03/2024	AURORA	30 (S/D)	CASARONE AGROINDUSTRIAL S.A.	07/10/2023	144
550018	14/03/2024	PATRICIA BLONDE	32 (S/D) y 33 (S/D)	FNC SOCIEDAD ANONIMA	01/06/2023	144

N° Exp	Resolución	Denominación	Clases	Titular	Vigencia	Ag.
550019	13/03/2024	FABRICAS NACIONALES DE CERVEZA S.A.	30 (S/D), 32 (S/D) y 33 (S/D)	FNC SOCIEDAD ANONIMA	30/06/2023	144
550189	14/03/2024	RONCHAMP POCITOS (mixta)	35 (S/D), 36 (S/D) y 37 (S/D)	Ernesto Rodrigo DAVIDSOHN BENET	05/08/2023	
550413	13/03/2024	SALUS	32	COMPAÑIA SALUS S.A.	21/07/2023	245
550414	13/03/2024	SALUS	30	COMPAÑIA SALUS S.A.	21/07/2023	245
550417	13/03/2024	ENUREV	5 (S/D)	NOVARTIS AG	13/11/2023	201
550418	13/03/2024	LOVATO (mixta)	7	LANDI RENZO S.p.A.	16/05/2023	201
550419	13/03/2024	TOVANOR	5 (S/D)	NOVARTIS AG	13/11/2023	201
550420	13/03/2024	DANIEL CASSIN	35	INDUTOP S.A.	05/07/2023	201
550421	13/03/2024	TRIUMPH	12 (S/D)	TRIUMPH DESIGNS LIMITED	10/07/2023	201
550423	13/03/2024	GO TRAVEL (mixta)	5 (S/D), 6 (S/D), 8 (S/D), 9 (S/D), 10 (S/D), 12 (S/D), 14 (S/D), 16 (S/D), 18 (S/D), 20 (S/D), 21 (S/D), 24 (S/D), 25 (S/D) y 35 (S/D)	DG CAPITAL LIMITED	13/06/2023	144
550424	13/03/2024	LIBRA	9 (S/D) y 11 (S/D)	VIVION S.A.	02/06/2023	144
550425	13/03/2024	ARIES	9 (S/D) y 11 (S/D)	VIVION S.A.	02/06/2023	144
550426	13/03/2024	BRINKS (mixta)	39 y 45	BRINK'S NETWORK INC.	03/09/2023	144
550427	13/03/2024	TRAZO (mixta)	16	DIEGO ALABAN	12/11/2023	144
550438	13/03/2024	SUPERGAS ANCAP (mixta)	4 (S/D)	ADMINISTRACION NACIONAL DE COMBUSTIBLES ALCOHOL Y PORTLAND	19/05/2023	201
550440	13/03/2024	MACROBIOTICA (mixta)	30 (S/D)	Sandybel SA	20/06/2023	
550444	02/04/2024	POLICAR	7	HECTOR CARDELINO S.A.	25/06/2023	144
550447	02/04/2024	COLCAFE	30	INDUSTRIA COLOMBIANA DE CAFÉ S.A.S	07/11/2023	212
550449	13/03/2024	STAHL (mixta)	1 (S/D)	STAHL INTERNATIONAL B.V.	31/10/2023	144
550450	13/03/2024	AMAZONAS	1	AMAZONAS PRODUTOS PARA	12/11/2023	144

N° Exp	Resolución	Denominación	Clases	Titular	Vigencia	Ag.
				CALÇADOS LTDA.		
550452	13/03/2024	ADVANCED FRESH	3 (S/D)	COLGATE-PALMOLIVE COMPANY	25/06/2023	201
550453	13/03/2024	COLGATE	3 (S/D) y 5 (S/D)	COLGATE-PALMOLIVE COMPANY	10/06/2023	201
550454	13/03/2024	COLGATE TOTAL ADVANCED FRESH	3 (S/D)	COLGATE-PALMOLIVE COMPANY	25/06/2023	201
550455	13/03/2024	MENNEN BABY MAGIC	3 (S/D) y 5 (S/D)	COLGATE-PALMOLIVE COMPANY	01/06/2023	201
550456	13/03/2024	MENNEN LADY DRY	3	COLGATE-PALMOLIVE COMPANY	28/06/2023	201
550517	14/03/2024	BURNER	5	LABORATORIOS MICROSULES S.A.	20/05/2023	
550560	13/03/2024	NOOTROPIL	5 (S/D)	GlaxoSmithKline Intellectual Property Limited	29/06/2023	216
550568	01/04/2024	\$ 3.000.000 (mixta)	16, 28, 36 y 41	BANCA DE CUBIERTA COLECTIVA DE QUINIELAS DE MONTEVIDEO	27/05/2023	245
550654	22/03/2024	FARMING (mixta)	30	FARMING S.A.	22/05/2023	154
550732	01/04/2024	RITZ	34 (S/D)	COMPAÑIA INDUSTRIAL DE TABACOS MONTE-PAZ	10/06/2023	245
550758	01/04/2024	PARMALAT	5 (S/D)	Parmalat S.p.A.	28/08/2023	192
550819	13/03/2024	FRIOGAS (mixta)	11	Verzetti, Juan Pablo	28/05/2023	245
550857	01/04/2024	TICO TICO	30 (S/D)	EDANREY S.A.	27/06/2023	181
550858	01/04/2024	RICARDITO	29 (S/D) y 30 (S/D)	EDANREY S.A.	31/08/2023	181
550862	01/04/2024	ALPARI	36	IP HOLDINGS (ANTIGUA) LIMITED	28/11/2023	144
550864	01/04/2024	GLORIA PASIÓN (mixta)	29 (S/D), 30 (S/D) y 32 (S/D)	GLORIA S.A.	28/11/2023	144
550895	12/03/2024	SPONGEBOB SQUAREPANTS	18 (S/D)	VIACOM INTERNATIONAL INC.	05/09/2023	194
550896	13/03/2024	DORA THE EXPLORER	18 (S/D)	VIACOM INTERNATIONAL INC.	05/09/2023	194
550899	13/03/2024	TILT	5 (S/D)	SYNGENTA PARTICIPATIONS AG	06/09/2023	194
550902	13/03/2024	DPMS	13 (S/D)	JJE Brands, LLC	06/09/2023	194
550909	13/03/2024	CHAJA	6	ARMCO URUGUAYA S.A.	08/09/2023	194
550912	13/03/2024	VOYAGER	12	FCA US LLC	10/09/2023	194
550913	13/03/2024	VALENTINO V (mixta)	14 y 35	SASSON, FLORENCIA	25/09/2023	194
550914	13/03/2024	AUTOK (mixta)	42	PATERNOSTRO, JULIO	29/09/2023	194

N° Exp	Resolución	Denominación	Clases	Titular	Vigencia	Ag.
550916	13/03/2024	AUTOKEY (mixta)	42	PATERNOSTRO, JULIO	13/10/2023	194
550917	13/03/2024	EMBASSY SUITES BY HILTON	43 (S/D)	Hilton Worldwide Manage Limited	30/09/2023	194
550918	13/03/2024	HOMEWOOD SUITES BY HILTON	43 (S/D)	Hilton Worldwide Manage Limited	30/09/2023	194
550919	13/03/2024	MONT BLANC (mixta)	9 (S/D), 14 (S/D), 16 (S/D) y 18 (S/D)	Montblanc-Simplo GmbH	27/08/2023	194
550920	13/03/2024	INSTYLE (mixta)	16 (S/D)	TI Gotham INC.	26/06/2023	194
550921	13/03/2024	100 AÑOS RESERVA FAMILIAR (mixta)	33	GIMENEZ MENDEZ S.R.L.	28/06/2023	220
550922	13/03/2024	AVANTRIP	39	ALMUNDO.COM S.R.L.	21/12/2022	154
550923	13/03/2024	EL DORADO	35, 42, 43, 44 y 45	POLAKOF Y CIA. S.A.	10/06/2023	94
550924	13/03/2024	RUISEÑOR	33	POLAKOF Y CIA. S.A.	30/07/2023	94
550925	13/03/2024	CELESTE (mixta)	9, 11, 18, 20, 21, 24 y 25	POLAKOF Y CIA. S.A.	19/09/2023	94
550926	13/03/2024	AVANTRIP	35	ALMUNDO.COM S.R.L.	21/12/2022	154
550928	13/03/2024	EL DORADO	9 (S/D), 11, 16 (S/D), 18, 24, 25, 28, 31 (S/D), 36, 37, 38, 39, 40 y 41	POLAKOF Y CIA. S.A.	05/11/2023	94
550930	13/03/2024	TUPPERWARE	1 (S/D), 2 (S/D), 3 (S/D), 4 (S/D), 5, 6 (S/D), 7 (S/D), 8 (S/D), 9 (S/D), 10 (S/D), 11 (S/D), 12 (S/D), 13 (S/D), 14 (S/D), 15, 16 (S/D), 17 (S/D), 18, 19 (S/D), 20 (S/D), 21 (S/D), 22 (S/D), 23 (S/D), 24, 25, 26 (S/D), 27 (S/D), 28 (S/D), 29, 30, 31	DART INDUSTRIES INC	03/06/2023	34

N° Exp	Resolución	Denominación	Clases	Titular	Vigencia	Ag.
			(S/D), 32, 33 y 34 (S/D)			
550932	13/03/2024	GAMBERONI (mixta)	30 (S/D)	VILLA LIMA S.A.	14/07/2023	212
550936	13/03/2024	KPM (mixta)	37 y 39	KPM S.R.L.	07/05/2023	249
550946	13/03/2024	VANRELL (mixta)	35 y 45	JUAN E. VANRELL S.A.	28/11/2023	144
550947	13/03/2024	COLORAMA	3 (S/D)	L' OREAL	24/11/2023	144
550948	13/03/2024	PIGMENCLAR	3 (S/D)	La Roche-Posay Laboratoire Dermatologique	12/11/2023	144
550949	13/03/2024	GLORIA BONLÉ (mixta)	29 (S/D), 30 (S/D) y 32 (S/D)	GLORIA S.A.	28/11/2023	144
550950	13/03/2024	GRUPO ROVIRA DESDE 1890 (mixta)	16, 35 y 39	ROVIRA, DIESTE Y CIA S.C.	02/09/2023	144
550951	13/03/2024	AIG (mixta)	36	AMERICAN INTERNATIONAL GROUP, INC.	14/06/2023	144
550952	13/03/2024	AIG (mixta)	36	AMERICAN INTERNATIONAL GROUP, INC.	14/06/2023	144
550958	15/03/2024	MP MEDICINA PERSONALIZADA LIDERES EN MEDICINA PRIVADA (mixta)	44	Sistema Integral de Asistencia Médica S.A.	03/06/2023	104
550960	13/03/2024	SILOSOLVE	1 (S/D)	Chr. Hansen A/S	18/06/2023	194
550966	13/03/2024	URUGUAY EMERGENCIA (mixta)	39	FEDERACIÓN DE PRESTADORES MÉDICOS DEL INTERIOR (FEPREMI) y IBINOR S.A.	01/08/2023	218
550983	22/03/2024	ECOSUPRA 95	4 y 12	ADMINISTRACION NACIONAL DE COMBUSTIBLES ALCOHOL Y PORTLAND	18/06/2023	201
551046	01/04/2024	CINDUTEJA	6 y 19	TRADEWINDS INTERNATIONAL CORPORATION B.V.	26/11/2023	201
551048	22/03/2024	EXACTA LA FORMA SUSTENTABLE DE CONSTRUIR (mixta)	19	SEBASTIAN DIEGO GOLDBERGER KONSTANDT	18/06/2023	144
551074	22/03/2024	ADEN	41	RICARDO DANIEL GRECO BASTIANELLI	06/12/2022	212

N° Exp	Resolución	Denominación	Clases	Titular	Vigencia	Ag.
551075	22/03/2024	SOLAR	7	SOLAR TURBINES INCORPORATED	04/06/2023	94
551084	22/03/2024	(figurativa)	25	VANS, INC.	10/11/2023	144
551085	01/04/2024	BIOTERRA (mixta)	1	MILTAY S.A.	19/07/2023	144
551088	01/04/2024	MARY KAY BLACK SPARKLING DIAMONDS	3 (S/D)	MARY KAY INC.	08/08/2023	144
551096	01/04/2024	TERSPLAST	19	DISAL S.A.	07/06/2023	179
551146	22/03/2024	DSI (mixta)	6 (S/D), 7 (S/D), 19 (S/D), 37 (S/D) y 42 (S/D)	DSI Underground IP Holdings Luxembourg S.à r.l	05/12/2023	144
551149	13/03/2024	SAP NETWEAVER	9 (S/D), 16 (S/D), 41 (S/D) y 42 (S/D)	SAP SE	18/08/2023	201
551151	13/03/2024	PANGIORNO (mixta)	30	LARINUR S.A.	17/06/2023	201
551153	13/03/2024	EXPLOTA TU LADO DIVERTIDO	32	PEPSICO, INC. (UNA CORPORACION DEL ESTADO DE CAROLINA DEL NORTE)	02/09/2023	201
551154	13/03/2024	QUAKER FRUT	32 (S/D)	THE QUAKER OATS COMPANY	09/09/2023	201
551157	13/03/2024	REGENT	5 (S/D)	Bayer Intellectual Property GmbH	05/08/2023	205
551160	13/03/2024	ALIETTE	5 (S/D)	BAYER S.A.S.	11/08/2023	205
551166	13/03/2024	XPRO	5 (S/D)	Bayer Intellectual Property GmbH	20/08/2023	205
551175	13/03/2024	PHILIPS (mixta)	7 (S/D), 8 (S/D), 9 (S/D), 10 (S/D) y 11 (S/D)	KONINKLIJKE PHILIPS N.V.	16/07/2023	34
551179	13/03/2024	POWERCORE	31 (S/D)	MONSANTO TECHNOLOGY LLC	20/08/2023	205
551183	13/03/2024	POWERCORE (mixta)	31 (S/D)	MONSANTO TECHNOLOGY LLC	20/08/2023	205
551184	13/03/2024	HIPP	5, 29, 30, 31 y 32	HIPP & CO	09/06/2023	219
551187	13/03/2024	OFICINA SOSA (mixta)	36	OFICINA SOSA LTDA. (conocida como Oficina Sosa)	09/08/2023	219
551188	13/03/2024	KYRO PLUS	32	QUINAS LTDA.	27/06/2023	245
551189	13/03/2024	LAURA	16, 38 y 41	EL PAIS S.A.	16/06/2023	245
551190	13/03/2024	WORKVIAL (mixta)	37	WORKVIAL S.A.	09/06/2023	245
551208	13/03/2024	FREESTYLE AUTO-ASSIST	9 (S/D)	Abbott Diabetes Care Inc.	04/09/2023	136

N° Exp	Resolución	Denominación	Clases	Titular	Vigencia	Ag.
551209	01/04/2024	SPOTCHEM	5 (S/D) y 10 (S/D)	ARKRAY, INC.	02/12/2023	136
551210	14/03/2024	BURGER KING (mixta)	29, 30, 32 y 43 (S/D)	Burger King Corporation	05/11/2023	136
551213	14/03/2024	AXE	16	Unilever Global IP Limited	20/11/2023	136
551218	14/03/2024	VESOMNI	5 (S/D)	Astellas Pharma Inc.	02/12/2023	136
551221	14/03/2024	(figurativa)	5 (S/D)	Astellas Pharma Inc.	03/12/2023	136
551226	14/03/2024	TVS NEO (mixta)	12 (S/D)	SUNDARAM-CLAYTON LIMITED	03/07/2023	94
551227	14/03/2024	HYPERVENOM	25 (S/D)	NIKE INNOVATE C.V. una sociedad holandesa limitada (commanditaire vennootschap) organizada y existente bajo las leyes de Holanda	04/12/2023	192
551230	22/03/2024	GLORIA NIÑOS (mixta)	29 (S/D)	GLORIA S.A.	06/12/2023	144
551231	22/03/2024	TRANSRE LONDON	36 (S/D)	TRANSATLANTIC HOLDINGS, INC.	06/12/2023	144
551233	14/03/2024	DIAPROKAL	5 (S/D), 29 (S/D), 30 (S/D) y 32 (S/D)	Société des Produits Nestlé S.A.	24/04/2023	212
551234	14/03/2024	IRIS (mixta)	3 (S/D)	HERMES INTERNATIONAL	06/09/2023	144
551237	22/03/2024	M (mixta)	32 (S/D) y 39 (S/D)	MAHOU S.A.	14/06/2023	217
551238	22/03/2024	MEBUTAR	5	LABORATORIOS ANDROMACO S.A.	09/08/2023	165
551241	14/03/2024	(figurativa)	6 (S/D), 7 (S/D) y 12 (S/D)	Link-Belt Cranes, L.P., LLLP	25/06/2023	247
551242	14/03/2024	(figurativa)	6 (S/D), 7 (S/D) y 12 (S/D)	Link-Belt Cranes, L.P., LLLP	29/06/2023	247
551243	14/03/2024	LINK - BELT	6 (S/D) y 7 (S/D)	Link-Belt Cranes, L.P., LLLP	29/06/2023	247
551244	14/03/2024	ANDES DELICADO DULZOR (mixta)	33	CERVECERIA Y MALTERIA QUILMES S.A.I.C.A. y G.	07/06/2023	144
551245	14/03/2024	COVEXIN	5	Intervet Inc.	10/06/2023	247
551246	14/03/2024	ANUKET NU (mixta)	25	ESTEFANY FABECKI CALERO	01/08/2023	247
551247	14/03/2024	GGI	35 (S/D), 36 (S/D) y 45 (S/D)	GGI IP GMBH	20/12/2022	34
551248	18/03/2024	VBI VET BRANDS INTERNATIONAL, INC. (mixta)	5 (S/D), 10 (S/D) y 21 (S/D)	Vet Brands International, Inc.	10/12/2022	194

N° Exp	Resolución	Denominación	Clases	Titular	Vigencia	Ag.
551249	18/03/2024	APPLUS + (mixta)	42 (S/D) y 45 (S/D)	APPLUS SERVICIOS TECNOLOGICOS, S.L.U	03/12/2023	34
551253	18/03/2024	VET BRANDS INTERNATIONAL, INC.	5 (S/D), 10 (S/D) y 21 (S/D)	Vet Brands International, Inc.	05/12/2022	194
551254	18/03/2024	TETRIS	9 y 28	TETRIS HOLDING LLC	28/06/2023	34
551256	18/03/2024	GREGSON'S G (mixta)	33 (S/D)	CAMPARI DO BRASIL LTDA.	11/12/2022	34
551258	18/03/2024	(figurativa)	9 (S/D), 16 (S/D), 25 (S/D), 28 (S/D), 35 (S/D), 36 (S/D), 38 (S/D), 39 (S/D), 41 (S/D), 42 (S/D) y 45 (S/D)	MICROSOFT CORPORATION	10/07/2023	228
551264	18/03/2024	PART OF YOUR WORLD	29 (S/D) y 30 (S/D)	AUGUST STORCK KG	22/08/2023	240
551265	18/03/2024	TALIZ	14 y 35	LIZARDO SCHATZ	17/11/2023	219
551266	18/03/2024	MATCHBOX	28 (S/D)	MATTEL, INC.	30/06/2023	94
551267	18/03/2024	ALCON	3 (S/D) y 44 (S/D)	ALCON INC.	09/07/2023	216
551268	18/03/2024	LENSX SOFTFIT	10 (S/D)	ALCON INC.	11/07/2023	216
551269	18/03/2024	REMARV	5 (S/D)	Glaxo Group Limited	13/08/2023	216
551270	18/03/2024	I SCIFORMA (mixta)	9 (S/D) y 42 (S/D)	LB3A S.A.S	04/11/2023	216
551271	18/03/2024	WILSON	28	WILSON SPORTING GOODS CO.	17/09/2023	216
551272	18/03/2024	CHORUS (mixta)	12 (S/D)	HYUNDAI MOTOR COMPANY	31/08/2023	216
551273	18/03/2024	TENNIS (mixta)	12 (S/D)	HYUNDAI MOTOR COMPANY	26/07/2023	216
551274	18/03/2024	BETIS/TORRES Y RIBELLES SEVILLA/RT (mixta)	29 (S/D)	TORRES Y RIBELLES, S.A.	16/07/2023	216
551275	18/03/2024	TOURMANIUM	3 (S/D), 10 (S/D) y 35 (S/D)	Nuga Medical Co., Ltd.	08/11/2023	94
551276	18/03/2024	IBIS STYLES HOTELS (mixta)	35 (S/D) y 43 (S/D)	ACCOR	06/11/2023	94
551277	18/03/2024	ACCOR	43 (S/D)	ACCOR	10/11/2023	94
551280	19/03/2024	LIMTECH	21	OBER S/A INDÚSTRIA E COMÉRCIO	25/11/2023	144
551281	19/03/2024	OBER (mixta)	24	OBER S/A INDÚSTRIA E COMÉRCIO	10/09/2023	144
551284	19/03/2024	UEFA CHAMPIONS LEAGUE (mixta)	4, 12, 29, 32, 36 y	UNION DES ASSOCIATIONS	08/10/2023	144

N° Exp	Resolución	Denominación	Clases	Titular	Vigencia	Ag.
			40	EUROPEENNES DE FOOTBALL (UEFA)		
551288	19/03/2024	EMERGO	45 (S/D)	Emergo Global Consulting LLC	20/08/2023	201
551289	19/03/2024	CALICO JACK	33 (S/D)	JIM BEAM BRANDS CO.	26/07/2023	194
551291	19/03/2024	PEPSI LIGHT (mixta)	32 (S/D)	PEPSICO, INC., UNA CORPORACIÓN DEL ESTADO DE CAROLINA DEL NORTE	01/10/2023	201
551292	19/03/2024	PAPAS CHIPS	29 (S/D)	PAPAS CHIPS S.A.	02/10/2023	201
551293	19/03/2024	GG (mixta)	1 (S/D), 2 (S/D), 3 (S/D), 4 (S/D), 6 (S/D), 7 (S/D), 8 (S/D), 9 (S/D), 10 (S/D), 11 (S/D), 12 (S/D), 13 (S/D), 14 (S/D), 16 (S/D), 17 (S/D), 19 (S/D), 20 (S/D), 21 (S/D), 22 (S/D), 23 (S/D), 26 (S/D), 27 (S/D), 28 (S/D) y 34 (S/D)	GUCCIO GUCCI S.P.A.	20/06/2023	212
551294	19/03/2024	PINNACLE	33	JIM BEAM BRANDS CO.	11/10/2023	194
551295	19/03/2024	HORWATH (mixta)	35 (S/D)	HORWARTH INTERNATIONAL REGISTRATION LTD.	27/10/2023	201
551296	19/03/2024	ULTRA MEGA	5 (S/D)	GNC HOLDINGS, LLC	14/08/2023	94
551297	19/03/2024	RAMICOR	5	EUROFARMA URUGUAY S.A.	19/09/2023	201
551299	19/03/2024	CRUZAN	33 (S/D)	CRUZAN VIRIL LTD	13/10/2023	194
551300	19/03/2024	TALIS	5	EUROFARMA URUGUAY S.A.	03/09/2023	201
551302	19/03/2024	AKRON (mixta)	9	SILAR SOCIEDAD ANONIMA	21/10/2023	194
551303	19/03/2024	OLOF	5	LABORATORIOS SAVAL S.A.	11/09/2023	201
551304	20/03/2024	COLLICO	30	PRODUCTOS COLLICO S.A.	08/12/2022	245
551305	19/03/2024	CIPROVAL	5 (S/D)	LABORATORIOS SAVAL S.A.	05/11/2023	201

N° Exp	Resolución	Denominación	Clases	Titular	Vigencia	Ag.
551306	19/03/2024	GLISTER	3 (S/D)	ALTICOR INC.	08/12/2023	34
551308	19/03/2024	AERMEC	11 (S/D)	AERMEC S.P.A.	08/07/2023	34
551319	20/03/2024	AGUA PURA DISPENSADORES (mixta)	40 y 43	OTECAR S.A.	02/07/2023	185
551320	20/03/2024	CLAN MURRAY	33 (S/D)	ALTROMAK LIMITED	18/06/2023	245
551325	20/03/2024	SYNNEX	9, 35 y 40	SYNNEX Corporation	12/06/2023	136
551326	20/03/2024	BRAVELLE	5	FERRING B.V.	21/07/2023	181
551329	20/03/2024	CLASE A	5 y 21	PONTYN S.A.	05/08/2023	144
551330	20/03/2024	SHOW DE TALENTOS (mixta)	41	HRU S.A.	05/08/2023	144
551331	20/03/2024	SOUL LIFE	28	MARÍA SOFÍA LASIDA SEVERI	06/12/2023	144
551332	20/03/2024	SURF HAIR	3 (S/D)	L'OREAL	01/12/2023	144
551333	21/03/2024	SOFTSHEEN CARSON (mixta)	3 (S/D)	L'OREAL	01/12/2023	144
551334	21/03/2024	EXPRESSIONIST	3 (S/D)	L'OREAL	02/12/2023	144
551335	21/03/2024	SWEET LIFE	29	ABEMOL S.A.	06/08/2023	144
551337	21/03/2024	SUPERMASA	16 y 28	CALAFATE PORTEÑO S.A.	11/07/2023	34
551338	21/03/2024	(figurativa)	5	GRUPO EMPRESARIAL BAGO S.A.	14/05/2023	181
551339	21/03/2024	BIG C BIG C (mixta)	32	JUGOS DEL URUGUAY S.A.	06/09/2023	201
551341	01/04/2024	CERAXON	5 (S/D)	FERRER INTERNACIONAL S.A.	30/09/2023	34
551342	21/03/2024	KALE (mixta)	6 (S/D)	KALE KILIT VE KALIP SANAYI ANONIM SIRKETI	13/11/2023	212
551349	21/03/2024	CARBOGASOL	5	Gramón Bagó de Uruguay S.A.	10/06/2023	181
551352	21/03/2024	CINERAMA (mixta)	41	CINERAMA INC.	10/06/2023	245
551356	02/04/2024	RAT-BAN	9 (S/D)	LEMU S.A.	09/08/2023	245
551360	21/03/2024	HYDRA REVITAL	3 (S/D)	Unilever Global IP Limited	21/11/2023	136
551361	21/03/2024	DULCORYL	1	AUGUSTO COELHO IMPORTADORES S.A.	01/09/2023	194
551362	22/03/2024	RONDA	31	AUGUSTO COELHO IMPORTADORES S.A.	27/09/2023	194
551363	22/03/2024	SIERA REGIONAL EXPORT	35	SIERA REGIONAL EXPORT S.A.	21/12/2022	201
551365	22/03/2024	CHARCO	43	LINTEC S.A.	13/08/2023	194

N° Exp	Resolución	Denominación	Clases	Titular	Vigencia	Ag.
551366	22/03/2024	CHARCO WHITE ROOMS (mixta)	43	LINTEC S.A.	06/12/2023	194
551369	22/03/2024	GELADIOL	5	LABORATORIOS ANDROMACO S.A.	08/08/2023	201
551370	22/03/2024	MIRACLE	5	LABORATORIOS MIRACLE SOCIEDAD DE RESPONSABILIDAD LIMITADA	10/09/2023	94
551374	14/03/2024	NYLOFLEX	1 (S/D) y 9 (S/D)	XSYS Germany GmbH	22/08/2023	201
551375	14/03/2024	PULGARCITO	35 y 41	BEIERSDORF AG	31/08/2023	201
551377	14/03/2024	SAVILLS	35, 36, 37 y 42	SAVILLS PLC	11/12/2023	144
551378	14/03/2024	SAVILLS (mixta)	35, 36, 37 y 42	SAVILLS PLC	11/12/2023	144
551381	22/03/2024	CASTAÑER (mixta)	18 (S/D), 25 (S/D) y 35 (S/D)	ESPADRILLES BANYOLES, S.L.	11/07/2023	144
551394	14/03/2024	YARTU (mixta)	12 (S/D)	HANGZHOU ZHONGCE RUBBER CO., LTD.	27/11/2023	34
551395	14/03/2024	CHAO YANG (mixta)	12 (S/D)	ZHONGCE RUBBER GROUP COMPANY LIMITED	27/11/2023	34
551398	14/03/2024	INSUPEN	10	LABORATORIO LIBRA S.A.	24/07/2023	129
551399	14/03/2024	PARQUIMEX	5	LABORATORIO LIBRA S.A.	16/07/2023	129
551400	14/03/2024	TOYOTA (mixta)	7 (S/D)	TOYOTA JIDOSHA KABUSHIKI KAISHA	26/07/2023	216
551401	14/03/2024	AHORRA PACK IDEAL	5 (S/D)	PRODUCTOS FAMILIA S.A.	10/06/2023	216
551411	14/03/2024	GLOBE GLOBE GLOBE INDUSTRIES CORPORATION (mixta)	17 (S/D)	GLOBE INDUSTRIES CORPORATION	25/11/2023	216
551412	01/04/2024	EXXONMOBIL (mixta)	1, 4, 16 y 17	Exxon Mobil Corporation	09/12/2023	136
551413	01/04/2024	INSANO (mixta)	32 (S/D)	EMPRESA DE ÁGUAS OURO FINO LTDA.	24/01/2023	212
551414	15/03/2024	(figurativa)	14 y 18	GUCCIO GUCCI S.P.A.	02/08/2023	212
551415	01/04/2024	SCATTEY (mixta)	19	RODRIGO CABRAL SAPORTA	11/09/2023	212
551417	14/03/2024	AEG (mixta)	9 (S/D)	AB ELECTROLUX	20/08/2023	201
551419	14/03/2024	BIARRITZ	43 (S/D)	BIARRITZ S.R.L	12/09/2023	144
551420	14/03/2024	WISDOM	21 (S/D)	WISDOM TOOTHBRUSHES LIMITED	11/04/2023	144

N° Exp	Resolución	Denominación	Clases	Titular	Vigencia	Ag.
551422	14/03/2024	SELECCIONES READER´S DIGEST	9 (S/D) y 16 (S/D)	THE READER'S DIGEST ASSOCIATION INC.	20/06/2023	144
551423	14/03/2024	COLGATE TOTAL	30 (S/D)	COLGATE-PALMOLIVE COMPANY	08/09/2023	201
551438	14/03/2024	SM SAAM	37 (S/D) y 39 (S/D)	SUDAMERICANA AGENCIAS AEREAS Y MARITIMAS S.A.	15/07/2023	34
551442	14/03/2024	FREMAX	12 (S/D)	FRAS-LE S.A.	08/10/2023	194
551446	14/03/2024	RICETEC (mixta)	31, 35, 42 y 44	RiceTec, Inc.	22/07/2023	34
551451	15/03/2024	CLEMENTONI (mixta)	16 (S/D) y 28 (S/D)	Clementoni S.P.A.	21/06/2023	104
551453	15/03/2024	AJISWEET (mixta)	1 (S/D) y 30 (S/D)	AJINOMOTO CO., INC.	10/04/2023	216
551454	14/03/2024	SUAVESEC	5 (S/D)	PRODUCTOS FAMILIA S.A.	10/05/2023	216
551456	14/03/2024	ACTOR	5	KONIG URUGUAY S.A.	18/06/2023	129
551457	14/03/2024	ALAÑA	3 (S/D), 9 (S/D), 14 (S/D), 18 (S/D), 25 (S/D) y 35 (S/D)	AZZEDINE ALAIA SAS	14/02/2023	194
551459	14/03/2024	VARIVIEW (mixta)	9 (S/D)	GrandVision Coöperatief U.A.	26/06/2023	192
551460	14/03/2024	SPIN SOLUCIONES PARA LA INDUSTRIA	1 y 29	CARLOS ALFREDO GUIGOU GRAJALES y DANIEL DOYENART MORELL	16/09/2023	192
551462	14/03/2024	CRISTALVO (mixta)	30 (S/D)	CAMIL ALIMENTOS S/A	06/08/2023	192
551463	14/03/2024	SWISSDREAM	30 (S/D)	Choco-Diffusion S.A.	22/10/2023	192
551482	14/03/2024	ACTAVIS (mixta)	1 (S/D), 3 (S/D), 5 (S/D), 41 (S/D) y 42 (S/D)	ACTAVIS GROUP PTC EHF	25/07/2023	227
551484	14/03/2024	CISNE ACALANTO	23 (S/D)	COATS CORRENTE LTDA.	12/03/2023	34
551491	14/03/2024	NIKZON	5	GENOMMA LAB INTERNACIONAL, S.A.B. DE C.V.	16/09/2023	245
551493	14/03/2024	SHOT B	5	GENOMMA LABORATORIES MEXICO, S.A. DE C.V.	03/10/2023	245
551494	14/03/2024	DANKE (mixta)	30	EDANREY S.A.	10/11/2023	245
551495	14/03/2024	FLIPPER	30	EDANREY S.A.	11/11/2023	245
551496	14/03/2024	CHOC´S (mixta)	30	EDANREY S.A.	20/11/2023	245

N° Exp	Resolución	Denominación	Clases	Titular	Vigencia	Ag.
551497	14/03/2024	NUTRICOCO	30	EDANREY S.A.	11/11/2023	245
551500	15/03/2024	ACEROLIT	6 y 19	TRADEWINDS INTERNATIONAL CORPORATION B.V.	09/12/2023	201
551501	15/03/2024	ACEROTEC	6 y 19	TRADEWINDS INTERNATIONAL CORPORATION B.V.	09/12/2023	201
551502	15/03/2024	JESÚS MARÍA	25 (S/D) y 41	INSTITUTO DE LAS RELIGIOSAS DE JESÚS MARÍA	20/06/2023	193
551503	18/03/2024	JM COLEGIO JESÚS MARÍA (mixta)	25 (S/D) y 41	INSTITUTO DE LAS RELIGIOSAS DE JESÚS MARÍA	20/08/2023	193
551506	01/04/2024	CASA GRANDE ARTE Y VIÑA (mixta)	33 y 41	MARIA FLORENCIA DE MAIO DITO y MARIA FRANCESCA DITO DI GIORNO	07/02/2023	
551507	15/03/2024	BEN 10 OMNIVERSE (mixta)	3 (S/D), 9 (S/D), 14 (S/D), 16 (S/D), 18 (S/D), 20 (S/D), 21 (S/D), 24 (S/D), 25 (S/D), 28 (S/D), 29 (S/D), 30 (S/D), 32 (S/D) y 41	THE CARTOON NETWORK, INC.	02/07/2023	216
551511	15/03/2024	VYNDAQEL	5 (S/D)	PFIZER INC.	30/09/2023	194
551514	15/03/2024	KUBOTA (mixta)	12 (S/D)	KUBOTA CORPORATION	23/04/2023	216
551515	15/03/2024	SECOND-CHANCE	5 (S/D)	Ascensia Diabetes Care Holdings AG	26/06/2023	216
551519	15/03/2024	PRADA - ÓPTICOS DESDE SIEMPRE (mixta)	35 y 39	ÓPTICA PRADA S.A.	25/06/2023	244
551521	15/03/2024	ICR	9	HOSTING S.A.	07/05/2023	218
551523	15/03/2024	VIMOTADINE	5	LABORATORIOS CASASCO S.A.I.C.	25/06/2023	218
551524	15/03/2024	ECOVACS (mixta)	7 (S/D), 9 (S/D) y 11 (S/D)	ECOVACS ROBOTICS CO., LTD	10/12/2023	34
551526	15/03/2024	WINBOT (mixta)	7 (S/D)	ECOVACS ROBOTICS CO., LTD	12/12/2023	34
551527	15/03/2024	DEEBOT (mixta)	7 (S/D)	ECOVACS ROBOTICS CO., LTD	12/12/2023	34
551528	15/03/2024	AIVA HELPING PEOPLE TO GET	35 y 36	AIVA TPA SERVICES S.A.	20/06/2023	218

N° Exp	Resolución	Denominación	Clases	Titular	Vigencia	Ag.
		THERE (mixta)				
551529	15/03/2024	MOVEMENT	28	BRUDDEN EQUIPAMENTOS LTDA.	28/06/2023	34
551536	15/03/2024	REN	3 (S/D)	REN Limited	29/11/2023	136
551545	15/03/2024	BASALOG	5	LABORATORIO LIBRA S.A.	05/08/2023	129
551546	15/03/2024	EMTENOF	5	LABORATORIO LIBRA S.A.	05/08/2023	129
551548	15/03/2024	ZQ	22 (S/D), 23 (S/D), 24 (S/D), 25 (S/D) y 27 (S/D)	The New Zealand Merino Company Limited	08/05/2023	136
551549	15/03/2024	ZQ (mixta)	22 (S/D), 23 (S/D), 24 (S/D), 25 (S/D) y 27 (S/D)	The New Zealand Merino Company Limited	08/05/2023	136
551550	15/03/2024	PIOJISAR	5	LABORATORIOS CAILLON & HAMONET S.A.C.I.	12/09/2023	201
551551	18/03/2024	(figurativa)	12, 18, 20, 25, 28 y 41	The Ergo Baby Carrier, Inc.	30/07/2023	194
551552	15/03/2024	TERRA NOSTRA (mixta)	29 y 30	FINESA TRADING S.A.	18/11/2023	201
551554	15/03/2024	KÜÜL COLOR SYSTEM (mixta)	3 (S/D)	NATTURA LABORATORIOS, S.A. DE C.V.	04/08/2023	201
551555	18/03/2024	FUNTOUR (mixta)	39	FRAGETUR S.A.	20/10/2023	201
551556	15/03/2024	LOCTITE	5 (S/D), 7 (S/D) y 10 (S/D)	Henkel IP & Holding GmbH	01/08/2023	201
551557	15/03/2024	NBC NATURAL BEAUTY CARE (mixta)	3 (S/D)	NATTURA LABORATORIOS, S.A. DE C.V.	04/08/2023	201
551558	15/03/2024	PUREX	3 (S/D)	Henkel Corporation	18/08/2023	201
551559	15/03/2024	RENUZIT	4 (S/D) y 5 (S/D)	Henkel Corporation	26/08/2023	201
551560	15/03/2024	SUPERBONDER	1 (S/D), 2 (S/D), 17 (S/D) y 19 (S/D)	Henkel IP & Holding GmbH	04/08/2023	201
551566	15/03/2024	HIPÓDROMO LAS PIEDRAS (mixta)	9, 28, 31, 35, 36, 41, 42, 43 y 44	HRU S.A.	20/08/2023	144
551572	15/03/2024	CHIQUITA R (mixta)	29 (S/D), 30 (S/D), 31 (S/D) y 32 (S/D)	CHIQUITA BRANDS L.L.C.	28/06/2023	34

N° Exp	Resolución	Denominación	Clases	Titular	Vigencia	Ag.
551573	15/03/2024	MATRIFEN	5 (S/D)	TAKEDA PHARMA A/S	10/06/2023	34
551574	15/03/2024	VENTISQUERO	33	VIÑA VENTISQUERO LIMITADA	26/06/2023	34
551576	15/03/2024	G.I.C. INTERNATIONAL HAIR (mixta)	10	GIC INTERNATIONAL S.R.L.	17/06/2023	34
551580	15/03/2024	(figurativa)	12	PAN AMERICAN ENERGY GROUP, S.L.	21/06/2023	94
551581	15/03/2024	(figurativa)	4	PAN AMERICAN ENERGY GROUP, S.L.	21/06/2023	94
551582	15/03/2024	AXION ENERGY (mixta)	45	PAN AMERICAN ENERGY GROUP, S.L.	21/06/2023	94
551583	15/03/2024	AXION ENERGY (mixta)	44	PAN AMERICAN ENERGY GROUP, S.L.	21/06/2023	94
551584	15/03/2024	AXION ENERGY (mixta)	43	PAN AMERICAN ENERGY GROUP, S.L.	21/06/2023	94
551585	15/03/2024	AXION ENERGY (mixta)	42	PAN AMERICAN ENERGY GROUP, S.L.	21/06/2023	94
551586	18/03/2024	AXION ENERGY (mixta)	41	PAN AMERICAN ENERGY GROUP, S.L.	21/06/2023	94
551587	18/03/2024	AXION ENERGY (mixta)	40	PAN AMERICAN ENERGY GROUP, S.L.	21/06/2023	94
551588	18/03/2024	AXION ENERGY (mixta)	39	PAN AMERICAN ENERGY GROUP, S.L.	21/06/2023	94
551589	18/03/2024	AXION ENERGY (mixta)	38	PAN AMERICAN ENERGY GROUP, S.L.	21/06/2023	94
551590	18/03/2024	AXION ENERGY (mixta)	37	PAN AMERICAN ENERGY GROUP, S.L.	21/06/2023	94
551591	18/03/2024	AXION ENERGY (mixta)	36	PAN AMERICAN ENERGY GROUP, S.L.	21/06/2023	94
551592	18/03/2024	AXION ENERGY (mixta)	35	PAN AMERICAN ENERGY GROUP, S.L.	21/06/2023	94
551593	18/03/2024	AXION ENERGY (mixta)	25	PAN AMERICAN ENERGY GROUP, S.L.	21/06/2023	94

N° Exp	Resolución	Denominación	Clases	Titular	Vigencia	Ag.
551594	18/03/2024	AXION ENERGY (mixta)	16	PAN AMERICAN ENERGY GROUP, S.L.	21/06/2023	94
551595	18/03/2024	AXION ENERGY (mixta)	12	PAN AMERICAN ENERGY GROUP, S.L.	21/06/2023	94
551598	18/03/2024	LATITUDE	12 (S/D)	COMPAGNIE GENERALE DES ETABLISSEMENTS MICHELIN	22/08/2023	201
551599	18/03/2024	BLOOMBERG.COM	36 (S/D), 38 (S/D) y 42 (S/D)	BLOOMBERG FINANCE L.P.	15/12/2023	201
551600	18/03/2024	DOLCE FRANCCESCA	41	ANDREA PAOLA PORTELA VERDE	29/11/2023	179
551605	18/03/2024	PC MAGAZINE (mixta)	9, 16, 35, 41 y 42 (S/D)	Ziff Davis, LLC	06/08/2023	194
551607	18/03/2024	DINACELL ELECTRÓNICA (mixta)	9, 35 y 42	DINACELL ELECTRONICA, SL	03/10/2023	94
551609	18/03/2024	NISMO	12 (S/D)	NISSAN JIDOSHA KABUSHIKI KAISHA (also trading as NISSAN MOTOR CO., LTD.)	13/11/2023	94
551610	18/03/2024	(figurativa)	12 (S/D)	NISSAN JIDOSHA KABUSHIKI KAISHA (also trading as NISSAN MOTOR CO., LTD.)	12/12/2023	94
551613	18/03/2024	ALELUYA	30 (S/D)	Alimentos Naturales-Natural Foods S.A.	20/06/2023	194
551615	18/03/2024	NOVOPRESSINA-V	5	INSTITUTO BIOLOGICO ARGENTINO S.A.I.C.	30/07/2023	219
551616	18/03/2024	TIENDAZERO	35 y 38	Palefox S.A.	10/06/2023	101
551617	18/03/2024	MEDIO Y MEDIO VUDU	33	CIRLON S.A.	22/07/2023	219
551621	18/03/2024	ANTEA ALLIANCE OF INDEPENDENT FIRMS	35 y 45	ASOCIACION ANTEA, ALIANZA DE EMPRESAS INDEPENDIENTES.	16/12/2023	220
551622	18/03/2024	SIDRA LEVE- SIDRA ESPUMANTE- TOKE-SIDRA ESPECIAL-FRESH APPLE-SIRVASE BIEN FRIA- ALCOHOL MINIMO 4.5 GL- CONTENIDO NETO 330ML- INDUSTRIA URUGUAYA. (mixta)	33 (S/D)	PADETEX S.A.	20/06/2023	219

N° Exp	Resolución	Denominación	Clases	Titular	Vigencia	Ag.
551624	18/03/2024	K (mixta)	2, 6 y 35	CROSER S.A.	24/06/2023	189
551625	18/03/2024	LITIHUN	5	SZABO S.A	15/12/2023	212
551626	18/03/2024	GN (mixta)	30 (S/D)	PANADERIA SAN JORGE S.A.	16/12/2023	212
551627	18/03/2024	DELISHOP	35	PIMENTÓN SRL	16/12/2023	212
551629	18/03/2024	INTERCOSMO IL MAGNIFICO	3 (S/D)	BEAUTYGE ITALY S.p.A.	16/12/2023	192
551630	18/03/2024	ELIZABETH ARDEN	3 (S/D)	BrandCo Elizabeth Arden 2020 LLC	25/11/2023	192
551631	18/03/2024	AUPEMA ASOCIACIÓN URUGUAYA DE PUBLICIDAD EXTERIOR Y MEDIOS AFINES (mixta)	35	GUZMAN ACOSTA Y LARA ROMERO	06/08/2023	192
551633	18/03/2024	FUNDACIÓN IMPULSO (mixta)	41	FUNDACIÓN IMPULSO	03/09/2023	94
551634	22/03/2024	LICEO IMPULSO (mixta)	41	FUNDACIÓN IMPULSO	03/09/2023	94
551639	18/03/2024	MICROPORT (mixta)	10 (S/D)	MicroPort Sinica Co., Ltd.	18/12/2023	201
551641	18/03/2024	UGUANA.COM (mixta)	38	BARANUR S.A.	20/06/2023	245
551645	18/03/2024	P PRESTIGE BY AUDIOVOX (mixta)	12 (S/D)	VOXX INTERNATIONAL CORPORATION	16/07/2023	94
551647	18/03/2024	ECOSS	11 (S/D)	Güntner AG & Co. KG	07/08/2023	136
551651	18/03/2024	BROER & ZUS	25	CRESKOTEC SA	03/12/2023	144
551652	18/03/2024	DELIBEST	29, 30 y 43	FEDIR S.A.	03/12/2023	144
551653	18/03/2024	DELIK	43	FEDIR S.A.	17/10/2023	144
551654	18/03/2024	COLEX-D	5 (S/D)	Corteva Agriscience LLC	12/12/2023	144
551655	18/03/2024	BURBERRY	3 (S/D), 18 (S/D), 24 (S/D), 25 (S/D) y 28 (S/D)	BURBERRY LIMITED	25/11/2023	144
551657	18/03/2024	MOLECOR (mixta)	7 (S/D)	MOLECOR TECNOLOGIA, S. L.	09/07/2023	34
551659	18/03/2024	TMK (mixta)	6 (S/D), 7 (S/D), 11 (S/D) y 19 (S/D)	OAO "TMK"	20/12/2022	194
551660	18/03/2024	TMK (mixta)	6 (S/D), 7 (S/D), 11 (S/D) y 19 (S/D)	OAO "TMK"	20/12/2022	194
551661	18/03/2024	GENUINE PAI PAI WORLD TESTED PERFORMANCE PROVEN (mixta)	12	PAI INDUSTRIES, INC.	19/12/2023	34

N° Exp	Resolución	Denominación	Clases	Titular	Vigencia	Ag.
551662	18/03/2024	PAI INDUSTRIES (mixta)	12	PAI INDUSTRIES, INC.	19/12/2023	34
551663	18/03/2024	GALANZ (mixta)	7	GUANGDONG GALANZ ENTERPRISES CO., LTD.	19/12/2023	34
551665	18/03/2024	COMPLET. E	5	INTERA BIOTECH S.A.	21/06/2023	201
551674	19/03/2024	SKULLCANDY (mixta)	9 y 25	SKULLCANDY, INC.	27/06/2023	212
551678	18/03/2024	ANTAEUS CHANEL (mixta)	3 (S/D)	CHANEL SARL	12/07/2023	34
551685	18/03/2024	BOCONCEPT (mixta)	20 (S/D), 21 (S/D) y 35 (S/D)	BOCONCEPT A/S	03/07/2023	181
551686	18/03/2024	MASSEY FERGUSON (mixta)	7 (S/D) y 12 (S/D)	MASSEY FERGUSON CORP.	14/10/2023	181
551689	18/03/2024	SHINE SPA	3 y 44 (S/D)	SHERATON INTERNATIONAL IP, LLC	20/08/2023	194
551690	18/03/2024	INTERNATIONAL DEVELOPMENT FINANCE CLUB - IDFC	35, 36 y 41	Corporación Andina de Fomento (CAF)	26/02/2023	221
551691	18/03/2024	CHERY (mixta)	7, 11 y 12	Chery Automobile Co., Ltd.	20/12/2023	221
551692	18/03/2024	(figurativa)	12 y 37	Chery Automobile Co., Ltd.	22/11/2023	221
551695	18/03/2024	LA GIOCONDA	30 (S/D)	COMPAÑIA OLEAGINOSA URUGUAYA S.A.I. y C.	31/08/2023	144
551696	18/03/2024	IBERIA	29 (S/D), 30 (S/D), 31 (S/D) y 32 (S/D)	COMPAÑIA OLEAGINOSA URUGUAYA S.A.I. y C.	31/08/2023	144
551697	18/03/2024	SOME ONE	25	ODISAN S.A.	21/11/2023	144
551698	18/03/2024	L LE CAF (mixta)	25	DNACT CO., LTD.	20/10/2023	245
551699	18/03/2024	KENZO (tridimensional)	3 (S/D)	KENZO	28/10/2023	245
551700	18/03/2024	LE CAF L (mixta)	25	DNACT CO., LTD.	07/07/2023	245
551701	18/03/2024	NEOSPORIN	3 y 5	LABORATORIO ION S.A.	11/07/2023	201
551702	18/03/2024	WORKSAFE (mixta)	9 (S/D)	BSB PARTICIPAÇÕES S/A	05/11/2023	34
551703	18/03/2024	CASABLANCA	2 (S/D)	SINTEPLAST S.A.	05/07/2023	245
551704	18/03/2024	WORKFLEX	9 (S/D)	BSB PARTICIPAÇÕES S/A	25/10/2023	34
551706	19/03/2024	FUNAI (mixta)	9 (S/D)	FUNAI ELECTRIC CO. LTD.	26/11/2023	245
551707	19/03/2024	LUCCHETTI, LA PASTA DE MAMA	30	MOLINOS RIO DE LA PLATA S.A.	17/12/2023	34
551708	19/03/2024	CROMO (mixta)	41	DOLSUR S.A.	19/12/2023	221
551709	19/03/2024	(figurativa)	45	PAN AMERICAN ENERGY GROUP,	26/06/2023	94

N° Exp	Resolución	Denominación	Clases	Titular	Vigencia	Ag.
				S.L.		
551710	19/03/2024	(figurativa)	44	PAN AMERICAN ENERGY GROUP, S.L.	26/06/2023	94
551711	19/03/2024	(figurativa)	43	PAN AMERICAN ENERGY GROUP, S.L.	26/06/2023	94
551712	19/03/2024	(figurativa)	42	PAN AMERICAN ENERGY GROUP, S.L.	27/06/2023	94
551713	19/03/2024	(figurativa)	41	PAN AMERICAN ENERGY GROUP, S.L.	27/06/2023	94
551714	19/03/2024	(figurativa)	40	PAN AMERICAN ENERGY GROUP, S.L.	27/06/2023	94
551715	19/03/2024	(figurativa)	39	PAN AMERICAN ENERGY GROUP, S.L.	27/06/2023	94
551716	19/03/2024	(figurativa)	38	PAN AMERICAN ENERGY GROUP, S.L.	27/06/2023	94
551717	19/03/2024	(figurativa)	37	PAN AMERICAN ENERGY GROUP, S.L.	27/06/2023	94
551718	19/03/2024	(figurativa)	36	PAN AMERICAN ENERGY GROUP, S.L.	27/06/2023	94
551719	19/03/2024	(figurativa)	35	PAN AMERICAN ENERGY GROUP, S.L.	27/06/2023	94
551720	19/03/2024	(figurativa)	25	PAN AMERICAN ENERGY GROUP, S.L.	27/06/2023	94
551721	19/03/2024	(figurativa)	16	PAN AMERICAN ENERGY GROUP, S.L.	27/06/2023	94
551722	19/03/2024	ETA (mixta)	14 (S/D)	ETA S.A. MANUFACTURE HORLOGÈRE SUISSE	26/07/2023	34
551723	19/03/2024	INTERNATIONAL	2 (S/D)	AKZO NOBEL COATINGS INTERNATIONAL B.V.	14/07/2023	34
551724	19/03/2024	MAGIMAX	21 (S/D)	KIMBERLY-CLARK WORLDWIDE, INC.	22/07/2023	34

N° Exp	Resolución	Denominación	Clases	Titular	Vigencia	Ag.
551725	19/03/2024	NISSIN (mixta)	29	NISSIN FOODS HOLDINGS CO., LTD.	17/12/2023	221
551726	19/03/2024	POP SWATCH (mixta)	14	SWATCH AG. (SWATCH SA) (SWATCH LTD.)	16/07/2023	34
551727	19/03/2024	TOP RAMEN (mixta)	30	NISSIN FOODS HOLDINGS CO., LTD.	17/12/2023	221
551736	19/03/2024	TACH	28	ASARAVICIUS LIPOVETSKY BETTINA Y MORALES WEGNER MANUELA SOCIEDAD DE HECHO	20/03/2023	212
551737	19/03/2024	ERIZO	28	ASARAVICIUS LIPOVETSKY BETTINA Y MORALES WEGNER MANUELA SOCIEDAD DE HECHO	20/03/2023	212
551738	19/03/2024	JOHNNIE WALKER GOLD LABEL RESERVE	33 (S/D)	DIAGEO BRANDS B.V.	15/07/2023	212
551739	19/03/2024	DOUBLE BLACK	33 (S/D)	DIAGEO BRANDS B.V.	25/07/2023	212
551749	19/03/2024	EL GORDITO IBEROAMERICANO (mixta)	16 (S/D), 28 (S/D) y 41 (S/D)	SOCIEDAD ESTATAL LOTERÍAS Y APUESTAS DEL ESTADO, S.M.E., S.A.	30/07/2023	201
551750	19/03/2024	ROBERTA ALLEN	20	FALABELLA S.A.	15/07/2023	181
551751	19/03/2024	RECCO (mixta)	11	S.A.C.I. FALABELLA	19/07/2023	181
551752	19/03/2024	EL MEDIANO IBEROAMERICANO (mixta)	16 (S/D), 28 (S/D) y 41 (S/D)	SOCIEDAD ESTATAL LOTERÍAS Y APUESTAS DEL ESTADO, S.M.E., S.A.	22/11/2023	201
551758	19/03/2024	NEW COLOR (mixta)	3 (S/D)	UNION S.R.L.	25/06/2023	94
551759	19/03/2024	CAREY (mixta)	3 (S/D)	UNION S.R.L.	07/11/2023	94
551761	19/03/2024	AKYNZEO	5 (S/D)	HELSINN HEALTHCARE S.A.	16/09/2023	216
551762	19/03/2024	LASSA MAXIWAYS	12 (S/D)	BRISA BRIDGESTONE SABANCI LASTIK SANAYI VE TICARET A.S.	02/04/2023	216
551764	19/03/2024	HITACHI (mixta)	11 (S/D)	KABUSHIKI KAISHA HITACHI SEISAKUSHO (D/B/A HITACHI, LTD.)	08/07/2023	216
551765	19/03/2024	(figurativa)	11 (S/D)	KABUSHIKI KAISHA HITACHI SEISAKUSHO (D/B/A HITACHI, LTD.)	08/07/2023	216
551766	20/03/2024	TERRAMAR LA BARRA / JOSE IGNACIO (mixta)	36 (S/D)	TERRAMAR PROPIEADADES S.A.	07/07/2023	181
551767	19/03/2024	NOSOTRAS MUA! NOSOTRAS	3 y 5	PRODUCTOS FAMILIA S.A.	24/05/2023	216

N° Exp	Resolución	Denominación	Clases	Titular	Vigencia	Ag.
		NOSOTRAS NOSOTRAS WOW NOSOTRAS YES!! NOSOTRAS NOSOTRAS NOSOTRAS NOSOTRAS NOSOTRAS YO NOSOTRAS YO NOSOTRAS NOSOTRAS NOSOTRAS NOSOTRAS NOSOTRAS NOSOTRAS NOSOTRAS NOSOTRAS NOSOTRAS NOSOTRAS NOSOTRAS NOSOTRAS NOSOTRAS NOSOTRAS NOSOTRAS NOSOTRAS NOSOTRAS YO NOSOTRAS NOSOTRAS NOSOTRAS NOSOTRAS NOSOTRAS NOSOTRAS YO NOSOTRAS NOSOTRAS NOSOTRAS NOSOTRAS YO NOSOTRAS NOSOTRAS NOSOTRAS NOSOTRAS NOSOTRAS (mixta)				
551770	19/03/2024	TROPICANA (mixta)	32 (S/D)	TROPICANA PRODUCTS, INC	25/07/2023	201
551771	19/03/2024	HUTCHINSON	17 (S/D) y 25 (S/D)	HUTCHINSON	31/08/2023	181
551773	19/03/2024	SERENIDAD PREVISORA FÚNEBRE PRE PAGA (mixta)	45 (S/D)	ROBERT ERNESTO ALFARO CASOTTI	05/08/2023	129
551775	19/03/2024	CK (mixta)	25	Calvin Klein Trademark Trust	28/10/2023	136
551777	19/03/2024	(figurativa)	5 (S/D)	CELLTRION, INC.	14/08/2023	201
551782	19/03/2024	SONY (mixta)	9 (S/D), 10 (S/D), 11 (S/D), 28 (S/D), 35 (S/D), 36 (S/D), 37 (S/D), 38 (S/D), 39 (S/D), 40 (S/D), 41 (S/D), 42 (S/D), 43 (S/D), 44 (S/D) y 45 (S/D)	Sony Group Corporation	31/07/2023	34
551784	19/03/2024	TEFAL	7 (S/D), 8 (S/D), 9	TEFAL	13/08/2023	34

N° Exp	Resolución	Denominación	Clases	Titular	Vigencia	Ag.
			(S/D) y 11 (S/D)			
551785	20/03/2024	VORTICE (mixta)	7 (S/D), 9 (S/D) y 11	VORTICE S.P.A.	31/08/2023	34
551786	20/03/2024	YOLADO	29 (S/D) y 30 (S/D)	COMPAGNIE GERVAIS DANONE	01/07/2023	245
551787	20/03/2024	(figurativa)	29 (S/D)	COMPAGNIE GERVAIS DANONE	08/07/2023	245
551788	20/03/2024	BNDES EXIM	36 (S/D)	BANCO NACIONAL DE DESENVOLVIMENTO ECONÔMICO E SOCIAL-BNDES	18/12/2023	212
551796	20/03/2024	NAIL EXPERTS	3 (S/D)	AVON PRODUCTS, INC.	14/07/2023	194
551798	20/03/2024	DEL MONTE	29 (S/D), 30 (S/D), 31 (S/D) y 32 (S/D)	Del Monte Foods, Inc.	31/08/2023	136
551802	20/03/2024	CARMELA (mixta)	29 (S/D)	CENTURY PACKING CORPORATION	15/12/2023	94
551803	20/03/2024	KAITACAR	35	KAITACAR SAS	09/01/2023	249
551804	20/03/2024	SAB ORES (mixta)	30	VERONICA SOLEDAD BERMUDEZ	24/06/2023	220
551805	20/03/2024	ABSOLU ROUGE	3 (S/D)	L'OREAL	22/12/2023	144
551806	20/03/2024	PURE RITUAL	3 (S/D)	L'OREAL	12/12/2023	144
551813	04/04/2024	(figurativa)	16 (S/D), 18 (S/D), 35 (S/D) y 39 (S/D)	SOCIETE AIR FRANCE	24/06/2023	154
551814	20/03/2024	TU (mixta)	9 (S/D), 35 (S/D), 38 (S/D), 41 (S/D) y 42 (S/D)	TELEFÓNICA DIGITAL ESPAÑA, S.L.U.	30/07/2023	201
551817	20/03/2024	MODUSIK-A OFTENÓ	5	SOPHIA HOLDINGS, S.A. DE C.V.	21/07/2023	34
551818	20/03/2024	SOPHIXIN DX UNGENA	5 (S/D)	SOPHIA HOLDINGS, S.A. DE C.V.	28/08/2023	34
551819	20/03/2024	LAKINOR (mixta)	3 y 5	LAKINOR S.A.	04/07/2023	34
551820	20/03/2024	FONDOMEDICAL	35 y 44	NELSON ARCOS S.A.	26/06/2023	201
551823	20/03/2024	FONDOMEDICAL (mixta)	35 y 44	NELSON ARCOS S.A.	26/06/2023	201
551828	20/03/2024	INNOFLU	5 (S/D)	Seqirus UK Limited	17/09/2023	194
551830	20/03/2024	VITAL + CONAPROLE (mixta)	29 (S/D) y 32	COOPERATIVA NACIONAL DE PRODUCTORES DE LECHE (CONAPROLE)	02/10/2023	194
551832	20/03/2024	PRESTAMO FACIL (mixta)	36 (S/D)	RETOP S.A.	02/10/2023	194

N° Exp	Resolución	Denominación	Clases	Titular	Vigencia	Ag.
551833	20/03/2024	AMERICAN EAGLE OUTFITTERS	25	RETAIL ROYALTY COMPANY	02/10/2023	194
551834	20/03/2024	FAISAN (mixta)	33	GRUPO TRAVERSA S.A.	10/10/2023	194
551835	01/04/2024	NICOLL (mixta)	6 (S/D), 9 (S/D), 11 (S/D) y 19 (S/D)	RACCORDS ET PLASTIQUES NICOLL	17/10/2023	194
551836	20/03/2024	A SERIES OF UNFORTUNATE EVENTS	9 (S/D), 25 (S/D), 28 (S/D) y 41 (S/D)	VIACOM INTERNATIONAL INC.	27/10/2023	194
551841	20/03/2024	KIDIBOO	29 (S/D) y 30 (S/D)	SAVENCIA SA	10/11/2023	192
551843	20/03/2024	CULTOR	12 (S/D)	Trelleborg Wheel Systems Czech Republic a.s.	07/11/2023	34
551844	20/03/2024	EMIRATES SKYCARGO (mixta)	39 (S/D)	EMIRATES	08/07/2023	94
551845	20/03/2024	NORDOX (mixta)	5 (S/D)	NORDOX AS	14/08/2023	34
551846	20/03/2024	COLORTREND (mixta)	2 (S/D)	Vibrantz Color Solutions Inc.	26/12/2023	34
551848	01/04/2024	LOWEPRO (mixta)	9 (S/D)	VIDENDUM MEDIA SOLUTIONS S.p.a.	14/07/2023	34
551853	20/03/2024	GARBATI	7 (S/D)	GARBATI BARCHIESI, IVANA y BARCHIESI MORICONI, FRANCESCA	27/06/2023	245
551856	20/03/2024	TACO BELL	29 (S/D)	TACO BELL CORP.	31/08/2023	144
551862	20/03/2024	ONE2ONE	35, 38 y 42	BARANUR S.A.	27/06/2023	245
551863	20/03/2024	PLAN CEIBAL (mixta)	9, 16, 35, 37, 38 y 45	CENTRO CEIBAL PARA EL APOYO A LA EDUCACION DE LA NIÑEZ Y LA ADOLESCENCIA	11/09/2023	220
551866	21/03/2024	COCINA FACIL (mixta)	16 (S/D)	EDITORIAL TELEVISA S.A. DE C.V.	01/09/2023	212
551867	20/03/2024	ERES	16	EDITORIAL TELEVISA S.A. DE C.V.	01/09/2023	212
551868	20/03/2024	SIGNODE (mixta)	6 (S/D), 7 (S/D) y 8 (S/D)	Signode International IP Holdings LLC	23/09/2023	94
551869	20/03/2024	FERTIUM MAXIMA	1 (S/D)	TERVALIS DESARROLLO, S.A.	05/07/2023	212
551872	20/03/2024	FERTIUM EXPERTIA	1 (S/D)	TERVALIS DESARROLLO, S.A.	05/07/2023	212
551874	20/03/2024	JAMES BUCHANAN'S	33 (S/D)	DIAGEO BRANDS B.V.	11/10/2023	212
551877	20/03/2024	DEKTON BY COSENTINO (mixta)	19 (S/D)	Cosentino Global, S.L.U.	18/12/2023	179
551879	20/03/2024	SVELTIA	10	DIEGO GERARDO CORIN	15/07/2023	179

N° Exp	Resolución	Denominación	Clases	Titular	Vigencia	Ag.
551881	20/03/2024	GLOBAL	34	COMPAÑIA INDUSTRIAL DE TABACOS MONTE-PAZ	16/07/2023	245
551882	20/03/2024	S. FRANCISCO (mixta)	34	COMPAÑIA INDUSTRIAL DE TABACOS MONTE-PAZ	09/07/2023	245
551883	20/03/2024	CORONADO (mixta)	34	COMPAÑIA INDUSTRIAL DE TABACOS MONTE-PAZ	09/07/2023	245
551885	20/03/2024	CICLON	32	CARIBBOUT EXPORT, CORP.	22/12/2023	144
551886	20/03/2024	FURLA	9 (S/D)	FURLA S.P.A.	07/07/2023	144
551887	20/03/2024	INTRAPATITO DE SAPOLIO (mixta)	3	INTRADEVCO INDUSTRIAL S.A.	26/12/2023	212
551888	21/03/2024	AMACITEL	3 (S/D)	MAXMIX PRODUTOS DE BELEZA LTDA - EPP	14/10/2023	34
551889	21/03/2024	COQUEL	3 (S/D)	MAXMIX PRODUTOS DE BELEZA LTDA - EPP	14/10/2023	34
551893	21/03/2024	EUCALAR	3 (S/D)	MAXMIX PRODUTOS DE BELEZA LTDA - EPP	14/10/2023	34
551897	21/03/2024	DAVENE (mixta)	3 (S/D)	MAXMIX PRODUTOS DE BELEZA LTDA - EPP	17/10/2023	34
551898	21/03/2024	HIGIPORO	3 (S/D)	MAXMIX PRODUTOS DE BELEZA LTDA - EPP	14/10/2023	34
551904	21/03/2024	SONAX	1 (S/D), 3 (S/D) y 37 (S/D)	SONAX GMBH	23/12/2023	144
551907	21/03/2024	LAV-TEL	3 (S/D)	MAXMIX PRODUTOS DE BELEZA LTDA - EPP	14/10/2023	34
551909	21/03/2024	LECHE DE AVENA	3 (S/D)	MAXMIX PRODUTOS DE BELEZA LTDA - EPP	16/10/2023	34
551910	21/03/2024	MULTILIMP	3 (S/D)	MAXMIX PRODUTOS DE BELEZA LTDA - EPP	14/10/2023	34
551911	21/03/2024	PAIOL	3 (S/D)	MAXMIX PRODUTOS DE BELEZA LTDA - EPP	14/10/2023	34
551913	21/03/2024	SOL DE VERÃO	3 (S/D)	MAXMIX PRODUTOS DE BELEZA LTDA - EPP	16/10/2023	34

N° Exp	Resolución	Denominación	Clases	Titular	Vigencia	Ag.
551915	21/03/2024	TACOLAC	3 (S/D)	MAXMIX PRODUTOS DE BELEZA LTDA - EPP	16/10/2023	34
551917	21/03/2024	(figurativa)	9 (S/D)	GEEHY MICROELECTRONICS INC.	27/12/2023	34
551921	21/03/2024	K KAWASAKI (mixta)	7 (S/D) y 12 (S/D)	KAWASAKI JUKOGYO KABUSHIKI KAISHA D.B.A. KAWASAKI HEAVY INDUSTRIES, LTD	05/11/2023	194
551922	21/03/2024	K (mixta)	7 (S/D) y 12 (S/D)	KAWASAKI JUKOGYO KABUSHIKI KAISHA D.B.A. KAWASAKI HEAVY INDUSTRIES, LTD	05/11/2023	194
551923	21/03/2024	KAWASAKI (mixta)	7 (S/D) y 12 (S/D)	KAWASAKI JUKOGYO KABUSHIKI KAISHA D.B.A. KAWASAKI HEAVY INDUSTRIES, LTD	07/11/2023	194
551924	21/03/2024	E EMBASSY SUITES (mixta)	43	Hilton Worldwide Manage Limited	05/11/2023	194
551928	21/03/2024	VESTEL	7 (S/D), 9 (S/D) y 11 (S/D)	VESTEL ELEKTRONIK SANAYI VE TICARET A.S.	07/08/2023	221
551932	21/03/2024	(figurativa)	12 (S/D)	PIAGGIO & C. S.p.A.	16/07/2023	144
551937	21/03/2024	LEGEND	15	VITONOR S.A.	10/12/2023	94
551939	21/03/2024	ARISTA	9 (S/D)	ARISTA RECORDS LLC	26/12/2023	201
551941	21/03/2024	EVERLAST	3	EVERLAST WORLD'S BOXING HEADQUARTERS CORPORATION	17/12/2023	201
551944	21/03/2024	NATUZZI (mixta)	20 (S/D)	NATUZZI S.P.A.	09/07/2023	201
551945	21/03/2024	PRELOX	5 y 29	HORPHAG RESEARCH MANAGEMENT S.A.	15/12/2023	201
551946	21/03/2024	QUILMES	32 (S/D)	CERVECERIA Y MALTERIA QUILMES S.A.I.C.A.G.	29/06/2023	144
551947	21/03/2024	PIZZA HUT	43 (S/D)	PIZZA HUT INTERNATIONAL, LLC.	31/08/2023	144
551948	21/03/2024	FIAT (mixta)	12 (S/D)	FIAT GROUP MARKETING & CORPORATE COMMUNICATION SPA	14/07/2023	144
551949	21/03/2024	PRODOMO	30 (S/D) y 43 (S/D)	Alois Dallmayr Kaffee oHG	14/11/2023	194
551951	21/03/2024	DALLMAYR	30 (S/D) y 43 (S/D)	Alois Dallmayr Kaffee oHG	14/11/2023	194
551952	21/03/2024	AD (mixta)	30 (S/D) y 43 (S/D)	Alois Dallmayr Kaffee oHG	14/11/2023	194

N° Exp	Resolución	Denominación	Clases	Titular	Vigencia	Ag.
551953	21/03/2024	URUGUAY OPEN	41	DIEGO PEREZ BURIN	18/11/2023	245
551954	21/03/2024	AD (mixta)	30 (S/D) y 43 (S/D)	Alois Dallmayr Kaffee oHG	14/11/2023	194
551956	21/03/2024	HOMEWOOD SUITES (mixta)	43	Hilton Worldwide Manage Limited	26/11/2023	194
551957	21/03/2024	HAMPTON INN	43	Hilton Worldwide Manage Limited	26/11/2023	194
551958	21/03/2024	HAMPTON INN (mixta)	43	Hilton Worldwide Manage Limited	26/11/2023	194
551960	22/03/2024	GALLO SNACKS (mixta)	30 (S/D)	MOLINOS RIO DE LA PLATA S.A.	26/12/2023	34
551961	22/03/2024	GALLO SNACKS BIZCOCHOS DE ARROZ SALADOS CROCANTES & HORNEADOS (mixta)	30 (S/D)	MOLINOS RIO DE LA PLATA S.A.	27/12/2023	34
551964	22/03/2024	GALLO SNACKS BIZCOCHOS DE ARROZ DULCES CROCANTES & HORNEADOS (mixta)	30 (S/D)	MOLINOS RIO DE LA PLATA S.A.	27/12/2023	34
551965	22/03/2024	(figurativa)	9, 16, 35, 38 y 41	Al Jazeera Media Network	01/09/2023	34
551969	22/03/2024	E GA A (mixta)	9 (S/D)	GIORGIO ARMANI S.p.A.	26/07/2023	34
551972	22/03/2024	MAX MARA	25	MAX MARA FASHION GROUP S.R.L.	16/08/2023	34
551983	22/03/2024	GEN RE (mixta)	36	GENERAL RE CORPORATION	24/11/2023	194
551986	22/03/2024	TARN-X (mixta)	3	JELMAR, LLC	30/07/2023	194
551987	22/03/2024	CREDI TRAVEL (mixta)	36 y 39	LOS CIPRESES S.A .	05/08/2023	19
551988	22/03/2024	EMISORA AZUL FM (mixta)	38 y 41	EMISORA AZUL LTDA.	26/11/2023	194
551990	22/03/2024	A ADOBE (mixta)	9	ADOBE INC.	10/10/2023	194
551991	22/03/2024	DOLCECHEFF	1 y 30	MOREIRA BESSO, GERARDO DANIEL	01/07/2023	189
551995	22/03/2024	QUIJOTE PLATINO	16	JUEGOS & CO. S.R.L.	17/07/2023	219
551996	22/03/2024	ECONO LODGE	43 (S/D)	Choice Hotels International, Inc.	17/09/2023	136
552004	22/03/2024	ISLAY MIST (mixta)	33	MACDUFF & CO. LTD.	10/10/2023	144
552006	22/03/2024	TOP-PHOS	1 (S/D)	COMPAGNIE FINANCIÈRE ET DE PARTICIPATIONS ROULLIER	12/08/2023	144
552010	22/03/2024	OPTIVE FUSION	5 (S/D)	ALLERGAN INC.	27/12/2023	201
552012	22/03/2024	TIP (mixta)	12 (S/D)	TIP DE MEXICO, S.A.P.I. DE C.V.	01/08/2023	181
552023	22/03/2024	NUTRILITE	29 y 30	ALTICOR INC.	29/12/2023	34

N° Exp	Resolución	Denominación	Clases	Titular	Vigencia	Ag.
552042	22/03/2024	ARMELI (mixta)	9	JOLISOL S.A.	03/07/2023	189
552048	22/03/2024	PRO YOU	3 (S/D)	Beautyge Beauty Group, S.L.	09/08/2023	247
552049	22/03/2024	VON DUTCH	25	ROYER BRANDS INTERNATIONAL S.A.R.L.	30/07/2023	247
552058	22/03/2024	(figurativa)	29 (S/D) y 30 (S/D)	ARCOR S.A.I.C.	30/06/2023	154
552063	22/03/2024	DIVANLITO	20 (S/D)	Divanlito S.A.C.I.F.	02/07/2023	144
552065	22/03/2024	CAP'N CRUNCH	30 (S/D)	THE QUAKER OATS COMPANY	20/10/2023	201
552067	22/03/2024	CHEEZ WHIZ	29 (S/D)	LACTALIS HERITAGE DAIRY, INC.	02/08/2023	201
552068	01/04/2024	TUBOFORM (mixta)	17 y 19	Fusger S.A	07/10/2023	245
552069	22/03/2024	CRACKER BARREL (mixta)	29 (S/D)	LACTALIS HERITAGE DAIRY, INC.	02/08/2023	201
552071	22/03/2024	SILISTON	1 (S/D) y 19 (S/D)	Saint-Gobain Argentina S.A.	30/06/2023	227
552072	22/03/2024	ENCYCLOPAEDIA BRITANNICA	9 (S/D), 16 (S/D) y 42 (S/D)	Encyclopædia Britannica, Inc.	31/12/2022	194
552073	22/03/2024	(figurativa)	34 (S/D)	ALFRED DUNHILL LIMITED	14/07/2023	194
552074	22/03/2024	(figurativa)	9, 12, 18, 25 y 28	SPEEDO HOLDINGS B.V.	10/09/2023	194
552076	22/03/2024	RICOLESO	1 (S/D), 3 (S/D), 4 (S/D), 5 (S/D), 7 (S/D), 10 (S/D), 20 (S/D), 21 (S/D), 22 (S/D), 29 (S/D), 30 (S/D), 31 (S/D) y 32 (S/D)	COOPERATIVA NACIONAL DE PRODUCTORES DE LECHE (CONAPROLE)	07/10/2023	194
552094	22/03/2024	BENESSERE	3, 43 y 44	AGROLAND S.A.	05/07/2023	216
552095	22/03/2024	TROFEO	29 y 30	Sulten S.A.	09/07/2023	216
552098	22/03/2024	KOBAYASHI (mixta)	3 (S/D), 5 (S/D), 10 (S/D) y 11 (S/D)	KOBAYASHI PHARMACEUTICAL CO., LTD.	02/07/2023	216
552099	22/03/2024	AJI-NO-MEN	29 (S/D) y 30 (S/D)	AJINOMOTO CO., INC.	11/07/2023	216
552100	22/03/2024	(figurativa)	36	Rothschild & Co Continuation Holdings AG	07/07/2023	216
552101	22/03/2024	KELLY	12 (S/D)	THE GOODYEAR TIRE & RUBBER COMPANY	14/07/2023	216

N° Exp	Resolución	Denominación	Clases	Titular	Vigencia	Ag.
552104	14/03/2024	STRELLSON	3 (S/D), 9 (S/D), 14 (S/D), 18 (S/D) y 25 (S/D)	STRELLSON AG	08/10/2023	144
552105	14/03/2024	SPEZYME	1	DANISCO US INC	03/09/2023	144
552106	14/03/2024	SOLUNION S (mixta)	36 (S/D)	SOLUNION SEGUROS, COMPAÑÍA INTERNACIONAL DE SEGUROS Y REASEGUROS, S.A.	22/07/2023	144
552107	14/03/2024	ZEOCAR FINISH LIGHT BLUE (mixta)	2	ZEOCAR S.A.	06/12/2023	144
552110	14/03/2024	LA MATEADA DE MI PAÍS CANARIAS CANARIAS CANARIAS (mixta)	30 y 41	CANARIAS S.A.	25/07/2023	94
552111	14/03/2024	UN MATE POR MI PAÍS CANARIAS CANARIAS CANARIAS (mixta)	30 y 41	CANARIAS S.A.	16/08/2023	94
552112	14/03/2024	ANDARIEGA	30	CANARIAS S.A.	22/08/2023	94
552113	14/03/2024	ATAHUALPA	30	CANARIAS S.A.	22/08/2023	94
552116	14/03/2024	OLIO ANNA DE SANCTIS (mixta)	3 (S/D)	RICARDO DANIEL ALEM	03/07/2023	144
552124	14/03/2024	ELITE (mixta)	16	CMPC TISSUE S.A.	19/07/2023	218
552125	14/03/2024	INTUITION	10 (S/D)	DePuy Synthes, Inc.	04/07/2023	194
552137	14/03/2024	FS&A FERNANDEZ SECCO & ASOCIADOS (mixta)	35, 36 y 45	GONZALO FERNÁNDEZ SECCO	04/12/2023	34
552145	14/03/2024	FRESHLOCK	3 (S/D)	THE PROCTER & GAMBLE COMPANY	02/07/2023	216
552146	15/03/2024	EPRISULES	5	LABORATORIOS MICROSULES URUGUAY S.A.	08/07/2023	
552147	15/03/2024	PHOSPHOTON	5	LABORATORIOS MICROSULES URUGUAY S.A.	08/07/2023	
552148	15/03/2024	JOHN DEERE (mixta)	35	DEERE & COMPANY	03/01/2024	201
552156	15/03/2024	HEAD (mixta)	12	Head Technology GmbH	23/09/2023	136
552159	15/03/2024	HEAD (mixta)	12	Head Technology GmbH	23/09/2023	136
552160	15/03/2024	ALGIDA	30 (S/D)	Unilever IP Holdings B.V.	15/12/2023	136

N° Exp	Resolución	Denominación	Clases	Titular	Vigencia	Ag.
552164	15/03/2024	(figurativa)	29	GENERAL MILLS, INC.	04/12/2023	144
552165	15/03/2024	GUSHERS	29	GENERAL MILLS, INC.	22/12/2023	144
552166	15/03/2024	FRUIT ROLL-UPS	29	GENERAL MILLS, INC.	17/12/2023	144
552168	15/03/2024	VMAX	9 (S/D)	DELL INC.	11/11/2023	144
552170	15/03/2024	(figurativa)	6 (S/D), 17 (S/D) y 19 (S/D)	UNITED STATES GYPSUM COMPANY	16/12/2023	144
552175	15/03/2024	JIMO PROTECOLOR (mixta)	2	JIMO QUIMICA INDUSTRIAL LTDA.	15/01/2023	34
552180	15/03/2024	ETRO (mixta)	18 y 25	ETRO S.P.A.	24/09/2023	34
552181	15/03/2024	ITAMARATY	30	ITAMARATY INDUSTRIA E COMERCIO S/A	26/11/2023	34
552182	15/03/2024	HISPANITAS	25	EMBOGA, S.A.	30/07/2023	34
552183	15/03/2024	MARIPRIST	5, 10 y 44	MSI REPRODUCTIVE CHOICES	11/07/2023	245
552184	15/03/2024	LE COQ SPORTIF (mixta)	18 (S/D) y 25 (S/D)	LCS International SAS	14/10/2023	245
552187	15/03/2024	HOME COLLECTION (mixta)	35	ROSENBERG, RICARDO ABEL	27/10/2023	245
552189	15/03/2024	HEALTHRIDER	28	iFIT Inc.	26/11/2023	245
552190	15/03/2024	FREEMOTION	28	iFIT Inc.	26/11/2023	245
552191	15/03/2024	IFIT	28 y 41	iFIT Inc.	26/11/2023	245
552192	15/03/2024	FLEET (mixta)	5 (S/D)	C.B. FLEET COMPANY, INCORPORATED	14/07/2023	245
552194	15/03/2024	RYZODEG	5 (S/D)	NOVO NORDISK A/S	03/12/2023	181
552195	15/03/2024	LINIO	35 (S/D)	TIN JADE GMBH	07/08/2023	181
552196	15/03/2024	ROBERTA ALLEN	28	FALABELLA S.A.	02/08/2023	181
552199	15/03/2024	CASIC	31 y 44	Cia. Agropecuaria de Siembra, Invernada y Cría (CASIC) S.A.	14/08/2023	94
552204	15/03/2024	DIATIV	1 (S/D)	IMERYS FILTRATION MINERALS, INC.	16/07/2023	247
552206	15/03/2024	CHARRUA (mixta)	19	CIMSA	04/12/2023	247
552207	15/03/2024	PLEXEMOR	5	ANTIA MOLL Y CIA. S.A.	09/07/2023	201
552214	15/03/2024	MOTOROLA DEFY	9 (S/D)	MOTOROLA TRADEMARK HOLDINGS, LLC	12/08/2023	144

N° Exp	Resolución	Denominación	Clases	Titular	Vigencia	Ag.
552215	15/03/2024	HELLOMOTO	9 (S/D), 38 (S/D) y 42 (S/D)	MOTOROLA TRADEMARK HOLDINGS, LLC	21/07/2023	144
552218	02/04/2024	POULAIN	29 y 30	ALBA SIMONE	10/09/2023	144
552221	02/04/2024	ETCHART PRIVADO	33	Pernod Ricard Argentina S.R.L.	13/10/2023	221
552222	02/04/2024	JANEIRO	33 (S/D)	PERNOD RICARD	13/10/2023	221
552223	02/04/2024	CRAFT MULTIMODAL URUGUAY	35 y 39	CRAFT MULTIMODAL LTDA.	25/07/2023	221
552225	02/04/2024	RH ROYAL HORSE (mixta)	31 (S/D)	NEOVIA	17/03/2023	34
552226	02/04/2024	LADY TEST	5	Norepley S.A.	14/07/2023	221
552228	02/04/2024	GRUPO QUALITY SOLUCIONES EN COMERCIO EXTERIOR (mixta)	39	GATINCO S.A.	07/07/2023	156
552229	02/04/2024	REQUETELIQUIDACION	16 (S/D), 18 (S/D), 20 (S/D), 22 (S/D), 23 (S/D), 24 (S/D), 25 (S/D) y 26 (S/D)	CHIC PARISIEN S.A.	10/08/2023	212
552230	04/04/2024	PIAF	18 y 25	PERAYA SRL	04/11/2023	212
552234	04/04/2024	BIOPERFECT DE NUVO	3	NUVÓ COSMÉTICOS S.A.	16/07/2023	34
552235	04/04/2024	STEPHANS	25 y 35	ABRAHAM DREIFUS	15/07/2023	245
552236	04/04/2024	EQUILIBRIUM DE NUVO	3 (S/D)	NUVO COSMETICOS S.A.	30/07/2023	34
552239	04/04/2024	BOHO (mixta)	18, 24 y 35	AYAPELU S.R.L.	03/12/2023	212
552249	04/04/2024	ROSENTHAL	18	D. D. S.A.	09/07/2023	189
552250	04/04/2024	TRANSIT	18	D.D. SA	11/07/2023	189
552264	04/04/2024	PACIFILBAG	18	PACIFIL S.A.	11/08/2023	245
552265	04/04/2024	TASHIRO TAKATA	16	PACIFIL S.A.	17/12/2023	245
552276	04/04/2024	SCANAVINI	6 y 9	INDUSTRIA METALURGICA SCANAVINI S.A.	04/08/2023	34
552278	04/04/2024	SYNGENTA (mixta)	1 (S/D), 5 (S/D), 16 (S/D), 31 (S/D), 42 (S/D) y 44 (S/D)	SYNGENTA PARTICIPATIONS AG	22/10/2023	194
552285	04/04/2024	LEFTIES	18 (S/D) y 35 (S/D)	INDUSTRIA DE DISEÑO TEXTIL, S.A. (INDITEX S.A.)	05/09/2023	201
552286	04/04/2024	PULL & BEAR	25 y 39	INDUSTRIA DE DISEÑO TEXTIL S.A.	03/09/2023	201

N° Exp	Resolución	Denominación	Clases	Titular	Vigencia	Ag.
				(INDITEX S.A.)		
552294	04/04/2024	MAGIC ERASER	21 (S/D)	THE PROCTER & GAMBLE COMPANY	15/07/2023	216
552295	04/04/2024	OLAY	5 y 32	THE PROCTER & GAMBLE COMPANY	04/08/2023	216
552296	04/04/2024	RINDEX	3 (S/D)	THE PROCTER & GAMBLE COMPANY	04/08/2023	216
552297	04/04/2024	ADVANCED KERATIN REPAIR	3 (S/D)	THE PROCTER & GAMBLE COMPANY	12/08/2023	216
552298	04/04/2024	PRESTOBARBA ULTRAGRIP SPORT	8 (S/D)	THE GILLETTE COMPANY LLC	28/08/2023	216
552299	04/04/2024	PRESTOBARBA ULTRAGRIP FUTBOL	8 (S/D)	THE GILLETTE COMPANY LLC	28/08/2023	216
552300	04/04/2024	MINORA	8 (S/D)	THE GILLETTE COMPANY LLC	31/08/2023	216
552301	04/04/2024	WHITELOCK	3 (S/D), 5 (S/D) y 21 (S/D)	THE PROCTER & GAMBLE COMPANY	05/09/2023	216
552302	04/04/2024	COMFORTIP	5 (S/D)	C.B. FLEET COMPANY, INCORPORATED	11/08/2023	245
552303	04/04/2024	(figurativa)	5 (S/D), 6 (S/D), 18 (S/D) y 31 (S/D)	Mars, Incorporated	26/11/2023	245
552307	04/04/2024	PULMONAR-OM	5 (S/D)	OM Pharma	07/07/2023	192
552308	04/04/2024	DAIICHI-SANKYO (mixta)	1 (S/D) y 5 (S/D)	DAIICHI SANKYO COMPANY, LIMITED	01/08/2023	192
552309	04/04/2024	DAIICHI-SANKYO (mixta)	1 (S/D) y 5 (S/D)	DAIICHI SANKYO COMPANY, LIMITED	02/08/2023	192
552311	04/04/2024	SPINOGLIO (mixta)	33, 41 y 43	MICEREY S.A.	11/09/2023	212
552312	04/04/2024	ANGLO	16, 25 y 41	INSTITUTO CULTURAL ANGLO-URUGUAYO	13/07/2023	201
552325	04/04/2024	TRAMAL	5 (S/D)	GRÜNENTHAL GMBH	04/09/2023	201
552326	04/04/2024	GALVITE	2	SWIMC LLC	10/09/2023	201
552328	04/04/2024	KEM Z10	2	SWIMC LLC	10/09/2023	201
552330	04/04/2024	MONTEVIDEOBOX (mixta)	39	HIPERTEX S.A.	28/11/2023	201

N° Exp	Resolución	Denominación	Clases	Titular	Vigencia	Ag.
552333	05/04/2024	PIRACANJUBA (mixta)	29	LATICINIOS BELA VISTA S.A.	07/08/2023	34
552334	05/04/2024	PIRAKIDS PIRACANJUBA (mixta)	29	LATICINIOS BELA VISTA S.A.	07/08/2023	34
552350	05/04/2024	E ELEMENT 119 (mixta)	11 (S/D)	FEMSA EMPAQUES, S.A. DE C.V.	19/12/2023	216
552351	05/04/2024	PS4 (mixta)	9 (S/D), 16 (S/D), 28 (S/D), 38 (S/D), 41 (S/D) y 42 (S/D)	SONY INTERACTIVE ENTERTAINMENT INC.	29/10/2023	216
552352	05/04/2024	SOS	30 (S/D)	HERBA RICEMILLS, S.L.U.	17/09/2023	216
552353	05/04/2024	GOOD YEAR (mixta)	28 (S/D)	THE GOODYEAR TIRE & RUBBER COMPANY	31/08/2023	216
552354	05/04/2024	LEUKOPLAST	5 (S/D)	BSN Medical GmbH	31/08/2023	216
552356	05/04/2024	SPA	5 (S/D)	PRODUCTOS FAMILIA S.A.	11/09/2023	216
552357	05/04/2024	NOSOTRAS SENSITIVE	3 (S/D) y 5 (S/D)	PRODUCTOS FAMILIA S.A.	23/08/2023	216
552358	05/04/2024	ZONA V	3 (S/D) y 5 (S/D)	PRODUCTOS FAMILIA S.A.	14/08/2023	216
552364	05/04/2024	PELTON & CRANE	10 (S/D)	KaVo Dental Technologies LLC	12/07/2023	201
552375	05/04/2024	WAGNER	12 (S/D)	Federal-Mogul Products US LLC	04/02/2023	34
552377	05/04/2024	FINLANDIA (mixta)	33 (S/D)	BROWN-FORMAN FINLAND LTD.	06/09/2023	201
552379	05/04/2024	WAGNER	1 (S/D) y 7 (S/D)	Federal-Mogul Products US LLC	23/06/2023	34
552380	05/04/2024	LOCKHEED	1 (S/D)	Federal-Mogul Products US LLC	10/05/2023	34
552381	05/04/2024	GUERRA E PAZ NA ESTRADA (mixta)	12 (S/D)	GUERRA IMPLEMENTOS RODOVIÁRIOS LTDA	06/02/2023	34
552382	05/04/2024	SPEED UNLIMITED (mixta)	32 y 33	ENERGY GROUP S.R.L.	12/07/2023	34
552384	05/04/2024	ZUPAY	30	OPRUMIN S.A.	30/07/2023	34
552385	05/04/2024	AVIA	18 (S/D)	American Sporting Goods Corporation	23/07/2023	194
552389	05/04/2024	FENIX	43	LORENZO EGIDIO ROMANENGHI	09/07/2023	154
552390	05/04/2024	AFIX (mixta)	1 (S/D), 16 (S/D) y 17 (S/D)	ARTECOLA QUIMICAS S/A.	31/05/2023	245
552392	05/04/2024	MAGNEX	5 (S/D)	SZABO S.A.	15/03/2023	212
552395	05/04/2024	DIAZEM	5	SZABO S.A.	19/03/2023	212
552399	05/04/2024	CIPROXXAK (mixta)	5	MEDIFARMA S.A.	16/05/2023	181
552400	05/04/2024	TOBRAXONA (mixta)	5	MEDIFARMA S.A.	16/05/2023	181

N° Exp	Resolución	Denominación	Clases	Titular	Vigencia	Ag.
552401	05/04/2024	CIPROLAK (mixta)	5	MEDIFARMA S.A.	16/05/2023	181
552402	05/04/2024	OCUCAPS	5	MEDIFARMA S.A.	16/05/2023	181
552403	05/04/2024	AKWA TEARS	5	MEDIFARMA S.A.	16/05/2023	181
552404	05/04/2024	AKWA R	5	MEDIFARMA S.A.	16/05/2023	181
552405	05/04/2024	AKW AGELAK	5	MEDIFARMA S.A.	16/05/2023	181
552406	05/04/2024	ACETAK	5	MEDIFARMA S.A.	16/05/2023	181
552409	05/04/2024	ENOXALOW	5	BLAU FARMACEUTICA S.A.	11/12/2023	181
552410	08/04/2024	BLAUBIMAX	5	BLAU FARMACEUTICA S.A.	11/12/2023	181
552411	08/04/2024	ONE BETA	5	BLAU FARMACEUTICA S.A.	12/12/2023	181
552412	08/04/2024	ONE FOR ONE	9 (S/D), 25 (S/D), 36 (S/D) y 45 (S/D)	MYCOSKIE LLC	08/01/2024	240
552413	08/04/2024	BLAUBUMIN	5	BLAU FARMACEUTICA S.A.	12/12/2023	181
552414	08/04/2024	BLAUKINASE	5	BLAU FARMACEUTICA S.A.	12/12/2023	181
552415	08/04/2024	BLAUTRIM	5	BLAU FARMACEUTICA S.A.	12/12/2023	181
552416	08/04/2024	BLAUBIO	5 y 35	BLAU FARMACEUTICA S.A.	12/12/2023	181
552417	08/04/2024	BLAU BIOTECH	5 y 35	BLAU FARMACEUTICA S.A.	12/12/2023	181
552418	08/04/2024	NEW FILGRASTINE	5	BLAU FARMACEUTICA S.A.	13/12/2023	181
552419	08/04/2024	MPEGOFERON	5	BLAU FARMACEUTICA S.A.	13/12/2023	181
552422	08/04/2024	CHAPANEL TEKILA	6	ARMCO URUGUAY S.A.	21/11/2023	181
552423	08/04/2024	NECTAR	5	LABORATORIOS DISPERT S.A.	18/08/2023	201
552425	08/04/2024	C (mixta)	23, 24 y 25	JOSÉ MATEO CAMPOMAR	18/11/2023	181
552428	08/04/2024	AUSTRAL	32 (S/D)	CERVECERIA AUSTRAL S.A.	01/08/2023	245
552430	08/04/2024	LORO PIANA DENIM FLOWER	24 (S/D)	LORO PIANA S.P.A.	23/09/2023	144
552432	08/04/2024	VANGUARDIA (mixta)	29 (S/D)	COMPANIA OLEAGINOSA URUGUAYA S.A.I. y C.	16/09/2023	144
552434	08/04/2024	LIEBERT ICOM (mixta)	9 (S/D)	Vertiv Corporation	02/09/2023	201
552446	08/04/2024	JH J. HARTWICH (mixta)	7	CARLOS HARTWICH	07/08/2023	34
552449	08/04/2024	LUZCA BIEN SIENTASE MEJOR (mixta)	41 (S/D)	PERSONAL CARE PRODUCTS COUNCIL FOUNDATION	28/08/2023	34
552451	08/04/2024	LOOK GOOD FEEL BETTER (mixta)	41 (S/D)	PERSONAL CARE PRODUCTS	28/08/2023	34

N° Exp	Resolución	Denominación	Clases	Titular	Vigencia	Ag.
				COUNCIL FOUNDATION		
552453	08/04/2024	LOOK GOOD FEEL BETTER HELPING WOMEN WITH CANCER (mixta)	41 (S/D)	PERSONAL CARE PRODUCTS COUNCIL FOUNDATION	28/08/2023	34
552455	08/04/2024	LUZCA BIEN SIENTASE MEJOR AYUDANDO A LAS MUJERES CON CANCER (mixta)	41 (S/D)	PERSONAL CARE PRODUCTS COUNCIL FOUNDATION	28/08/2023	34
552464	08/04/2024	CORNETTO	30 (S/D)	Unilever IP Holdings B.V.	15/12/2023	136
552466	08/04/2024	KIRBY	9 (S/D)	Nintendo of America Inc.	10/10/2023	136
552467	08/04/2024	(figurativa)	9 y 28	Nintendo of America Inc.	08/10/2023	136
552468	08/04/2024	SUPER NES	9 y 28	Nintendo of America Inc.	08/10/2023	136
552470	08/04/2024	DRAGER (mixta)	10	MARIA CRISTINA PORTA	03/09/2023	220
552471	01/04/2024	MACROFURAN	5	ICU-VITA S.A.	04/08/2023	201
552472	01/04/2024	WOOFER (mixta)	9 y 11	WOOFER PRO LTDA.	15/07/2023	94
552474	01/04/2024	LATIN OIL (mixta)	4, 35 y 39	LATIN OIL S.A.	03/12/2023	201
552477	01/04/2024	LINDT EXCELLENCE LINDT (mixta)	30 (S/D)	Chocoladefabriken Lindt & Sprüngli AG	05/08/2023	179
552478	04/04/2024	RHODIANYL	22, 25 y 27	SOLVAY FRANCE	02/12/2023	179
552479	01/04/2024	SALVATORE FERRAGAMO SIGNORINA ELEGANZA	3	SALVATORE FERRAGAMO S.P.A.	31/10/2023	245
552481	02/04/2024	GENERAL (mixta)	12 (S/D)	CONTINENTAL TIRE THE AMERICAS LLC	15/09/2023	201
552482	02/04/2024	VDO (mixta)	7 (S/D), 8 (S/D), 9 (S/D), 11 (S/D), 12 (S/D), 16 (S/D), 35 (S/D), 36 (S/D), 37 (S/D) y 42 (S/D)	Continental Automotive Technologies GmbH	17/09/2023	201
552483	02/04/2024	GESTAGEN	5	LABORATORIO GADOR S.A.	16/09/2023	217
552484	02/04/2024	ERMENEGILDO ZEGNA (mixta)	18 (S/D), 24 (S/D) y 25 (S/D)	CONSITEX S.A.	05/12/2023	144
552488	02/04/2024	TINKERBELL	3 (S/D)	DISNEY ENTERPRISES, INC.	16/09/2023	144
552489	02/04/2024	MICKEY MOUSE (mixta)	25 y 28	DISNEY ENTERPRISES, INC.	10/10/2023	144

N° Exp	Resolución	Denominación	Clases	Titular	Vigencia	Ag.
552490	02/04/2024	(figurativa)	3, 21, 25, 28, 29, 30, 32 y 41	DISNEY ENTERPRISES, INC.	23/10/2023	144
552491	02/04/2024	(figurativa)	3, 21, 25, 28 y 41	DISNEY ENTERPRISES, INC.	23/10/2023	144
552493	02/04/2024	DISNEY	3	DISNEY ENTERPRISES, INC.	10/11/2023	144
552494	02/04/2024	CHOCOCAT (mixta)	22 (S/D)	SANRIO COMPANY, LTD.	04/09/2023	201
552495	02/04/2024	SERENATA DE AMOR	30	CHOCOLATES GAROTO S.A	09/07/2023	34
552496	02/04/2024	(tridimensional)	30 (S/D)	SOCIETE DES PRODUITS NESTLE S.A.	21/08/2023	34
552498	02/04/2024	AFTER EIGHT (mixta)	30 (S/D)	SOCIETE DES PRODUITS NESTLE S.A.	01/09/2023	34
552499	02/04/2024	MINI ME	11 (S/D)	SOCIETE DES PRODUITS NESTLE S.A.	04/09/2023	34
552500	02/04/2024	VERTUO	11 (S/D), 21 (S/D) y 30 (S/D)	SOCIETE DES PRODUITS NESTLE S.A.	10/09/2023	34
552501	02/04/2024	ZENPEP	5 (S/D)	Société des Produits Nestlé S.A.	11/09/2023	34
552502	02/04/2024	(figurativa)	11 (S/D), 32 (S/D) y 43 (S/D)	SOCIETE DES PRODUITS NESTLE S.A.	22/09/2023	34
552503	02/04/2024	MILO	5 (S/D) y 32 (S/D)	SOCIETE DES PRODUITS NESTLE S.A.	30/09/2023	34
552510	02/04/2024	LV (mixta)	16 (S/D)	LOUIS VUITTON MALLETIER	15/12/2023	245
552511	02/04/2024	ZEPHYR	18 (S/D)	LOUIS VUITTON MALLETIER	30/12/2023	245
552512	02/04/2024	TAMBOUR	14 (S/D)	LOUIS VUITTON MALLETIER	29/12/2023	245
552516	02/04/2024	KAOPECTATE	5 (S/D)	GENOMMA LAB INTERNACIONAL, S.A.B. DE C.V.	26/12/2023	245
552518	02/04/2024	REGO	9	Engineered Controls International, LLC	06/08/2023	194
552519	02/04/2024	REGO (mixta)	9	Engineered Controls International, LLC	17/12/2023	194
552521	02/04/2024	ENI I-RIDE (mixta)	4	ENI S.P.A.	02/08/2023	194
552522	02/04/2024	ENI I-BASE	4	ENI S.P.A.	02/08/2023	194
552523	02/04/2024	ENI I-SINT	4	ENI S.P.A.	02/08/2023	194
552525	02/04/2024	(figurativa)	34 (S/D)	SOUZA CRUZ LTDA	22/08/2023	194

N° Exp	Resolución	Denominación	Clases	Titular	Vigencia	Ag.
552526	02/04/2024	SHUANGXI (mixta)	34 (S/D)	CTBAT International Co Limited	27/09/2023	194
552527	02/04/2024	SANCHO PANZA	3, 16, 25 y 28	MIGUEL ANGEL GIMENEZ	23/07/2023	220
552528	03/04/2024	555 STATE EXPRESS (mixta)	25	ARDATH TOBACCO COMPANY LIMITED	12/10/2023	194
552529	03/04/2024	R (mixta)	34 (S/D)	Rothmans of Pall Mall Limited	31/10/2023	194
552530	03/04/2024	CARLTON (mixta)	34	SOUZA CRUZ LTDA	06/11/2023	194
552531	03/04/2024	CARLTON	34	SOUZA CRUZ LTDA	18/12/2023	194
552533	03/04/2024	VENIER	3 (S/D)	PRODUCTOS VENIER S.A.	08/09/2023	201
552540	03/04/2024	VA (mixta)	18 y 25	BOARDRIDERS IP HOLDINGS, LLC	07/08/2023	201
552542	03/04/2024	GAZYVA	5 (S/D)	F. HOFFMANN - LA ROCHE AG.	02/12/2023	201
552544	03/04/2024	HYBPROBE (mixta)	1 (S/D) y 5 (S/D)	ROCHE DIAGNOSTICS GMBH	27/10/2023	201
552547	03/04/2024	B BRAUN (mixta)	3 (S/D), 5 (S/D), 10 (S/D) y 44 (S/D)	B. BRAUN MELSUNGEN AG.	28/10/2023	179
552548	03/04/2024	(figurativa)	29, 30 y 43	GENERAL MILLS MARKETING, INC.	04/12/2023	144
552552	03/04/2024	FANAM (mixta)	9	BENITEZ PREVE, FERNANDO ENRIQUE	21/08/2023	201
552554	03/04/2024	SIMPLEPROBE (mixta)	1 (S/D) y 5 (S/D)	ROCHE DIAGNOSTICS GMBH	27/10/2023	201
552559	03/04/2024	PHARMATON NATURAL HEALTH PRODUCTS (mixta)	5 (S/D), 29 (S/D) y 30 (S/D)	Opella Healthcare Switzerland AG	26/09/2023	201
552560	03/04/2024	AMANECERES DEL DAYMAN	33	MOREIRA BURASTERO, VIRGINIA ERIKA	24/09/2023	201
552561	03/04/2024	FRYMA (mixta)	3	FRYMA S.A.	09/08/2023	201
552562	03/04/2024	CENTIPEDE	9 y 28	ATARI INTERACTIVE, INC.	01/09/2023	181
552573	03/04/2024	DUTICO	5	ZODIAC INTERNATIONAL CORPORATION	09/08/2023	245
552574	03/04/2024	NOLVER (mixta)	5	ZODIAC INTERNATIONAL CORPORATION	01/09/2023	245
552575	03/04/2024	NORTON	34 (S/D)	COMPAÑIA INDUSTRIAL DE TABACOS MONTE-PAZ	02/08/2023	245
552576	03/04/2024	CERRITO	34 (S/D)	COMPAÑIA INDUSTRIAL DE TABACOS MONTE-PAZ	12/08/2023	245

N° Exp	Resolución	Denominación	Clases	Titular	Vigencia	Ag.
552577	03/04/2024	FRESH	34 (S/D)	COMPAÑIA INDUSTRIAL DE TABACOS MONTE-PAZ	02/08/2023	245
552578	03/04/2024	NIAGARA	34 (S/D)	COMPAÑIA INDUSTRIAL DE TABACOS MONTE-PAZ	31/08/2023	245
552579	03/04/2024	SAMSUNG (mixta)	24 (S/D)	Samsung C&T Corporation	16/08/2023	34
552582	04/04/2024	MATCH	3 (S/D)	LANYVEL S.A.	24/09/2023	219
552583	04/04/2024	MERKUR (mixta)	9 (S/D) y 28 (S/D)	adp Merkur GmbH	02/09/2023	240
552584	04/04/2024	AA ARACRUZ (mixta)	1 y 16	SUZANO S.A.	16/07/2023	34
552585	04/04/2024	ARACRUZ	1 y 16	SUZANO S.A.	16/07/2023	34
552586	04/04/2024	MAXLIFE	9	PEREZ, VICTOR	10/09/2023	194
552594	04/04/2024	CHIRON	12 (S/D), 25 (S/D) y 28 (S/D)	Bugatti International S.A.	17/12/2023	219
552596	04/04/2024	AMSTEL BEER 1870 A AMSTEL AMSTEL BREWED TO THE AMSTEL TRADITION LAGER (mixta)	32 (S/D)	Amstel Brouwerij B.V.	25/11/2023	194
552597	04/04/2024	HOTDEAL (mixta)	8 (S/D)	SAAME TOOLS (SHAANXI) IMPORT & EXPORT CO., LTD.	11/12/2023	201
552600	04/04/2024	EQUIFAX (mixta)	35 y 36	EQUIFAX URUGUAY S.A.	10/11/2023	194
552609	04/04/2024	CARTA VIEJA	33	VIÑA DEL PEDREGAL S.A.	16/07/2023	34
552610	04/04/2024	DENHAM THE JEANMAKER	25 (S/D)	Denham Group B.V.	23/07/2023	245
552612	04/04/2024	FCB FCBARCELONA (mixta)	32 (S/D)	FUTBOL CLUB BARCELONA	16/07/2023	34
552615	04/04/2024	NATEVIA	5	MEGA LABS S.A.	02/12/2023	144
552616	04/04/2024	SUSTEVIA	5 (S/D)	MEGA LABS S.A.	02/12/2023	144
552617	04/04/2024	ABIRATRAL	5	MEGA LABS S.A.	03/12/2023	144
552618	04/04/2024	COPTRIVUL	5	MEGA LABS S.A.	03/12/2023	144
552619	04/04/2024	CUPTRES	5	MEGA LABS S.A.	03/12/2023	144
552620	05/04/2024	DECINER	5	MEGA LABS S.A.	03/12/2023	144
552622	05/04/2024	DIORECIN	5	MEGA LABS S.A.	03/12/2023	144
552623	05/04/2024	DIRIMARTIL	5	MEGA LABS S.A.	03/12/2023	144
552624	05/04/2024	DIUVAMOT	5	MEGA LABS S.A.	03/12/2023	144

N° Exp	Resolución	Denominación	Clases	Titular	Vigencia	Ag.
552631	05/04/2024	RISEDRON	5	Gramón Bagó de Uruguay S.A.	14/07/2023	181
552636	05/04/2024	GUA ZU (mixta)	29 (S/D) y 30 (S/D)	PAFRIMA LTDA.	16/07/2023	129
552640	05/04/2024	MAIZENA	5 (S/D), 29 (S/D), 30 (S/D) y 32 (S/D)	Conopco, Inc.	29/12/2023	136
552643	05/04/2024	FILIANCE	5 (S/D)	Abbott Healthcare Products B.V.	13/10/2023	136
552644	05/04/2024	PULZIUM	5 (S/D)	Abbott Healthcare Products B.V.	13/10/2023	136
552646	05/04/2024	W .R. BERKLEY CORPORATION (mixta)	36	BERKLEY INTERNATIONAL LATINOAMÉRICA S.A.	21/10/2023	94
552649	05/04/2024	INTEX	20	INTEX MARKETING, LTD.	07/10/2023	201
552650	05/04/2024	AIR LOCK (mixta)	11, 12, 20 y 28	INTEX MARKETING, LTD.	07/10/2023	201
552651	05/04/2024	SISMED - SISTEMA PRIVADO DE ATENCIÓN MÉDICA (mixta)	44 (S/D)	SUMMUM Medicina Privada S.A.	09/09/2023	34
552660	08/04/2024	ENDEAVOR	35	ENDEAVOR GLOBAL INC.	11/08/2023	194
552670	05/04/2024	AGRIPEN	5	GRAMON BAGO DE URUGUAY S.A.	02/08/2023	212
552671	05/04/2024	ENDEAVOR URUGUAY	35	ENDEAVOR GLOBAL INC.	11/08/2023	194
552672	05/04/2024	ARGENZIL APITER	5	APITER LTDA.	27/08/2023	212
552673	05/04/2024	ERIBIOTAN	5	GRAMON BAGO DE URUGUAY S.A.	31/08/2023	212
552674	08/04/2024	NITIDIN	5	GRAMON BAGO DE URUGUAY S.A.	23/09/2023	212
552676	08/04/2024	GRAMON (mixta)	3, 5, 16 y 35	GRAMON BAGO DE URUGUAY S.A.	22/10/2023	212
552679	08/04/2024	RIACHUELO	24 y 25	LOJAS RIACHUELO S.A.	27/08/2023	212
552680	08/04/2024	CAF	9	NEOROL S.A.	21/07/2023	219
552681	08/04/2024	CF	9	NEOROL S.A.	21/07/2023	219
552684	08/04/2024	BARRY CALLEBAUT (mixta)	30 (S/D)	Barry Callebaut AG	07/11/2023	94
552685	08/04/2024	PERMABOND ENGINEERING ADHESIVES	1 (S/D)	Loxel Srl	21/10/2023	194
552686	08/04/2024	CUANTICA	37 (S/D)	FROS BOGA, ALEJANDRO	03/09/2023	144
552689	08/04/2024	VANISH	3 (S/D)	Reckitt Benckiser Vanish B.V.	29/12/2023	144
552691	08/04/2024	E. COINTREAU (tridimensional)	33 (S/D)	COINTREAU	22/10/2023	144
552699	08/04/2024	COOGI	25	COOGI PARTNERS LLC	15/09/2023	201
552700	08/04/2024	ABA	5 (S/D)	Elianur S.A.	18/10/2023	194

N° Exp	Resolución	Denominación	Clases	Titular	Vigencia	Ag.
552705	08/04/2024	LAKA	30	MONDELEZ BRASIL LTDA.	04/10/2023	227
552706	08/04/2024	DAIRY MILK	30 (S/D)	CADBURY UK LIMITED	08/10/2023	227
552707	08/04/2024	TRILOGIA	30 (S/D)	INTERCONTINENTAL GREAT BRANDS LLC	23/10/2023	245
552709	08/04/2024	RICOLINO CHOCO RETAS (mixta)	30	INTERCONTINENTAL GREAT BRANDS LLC	15/10/2023	245
552710	08/04/2024	LU	30 (S/D)	GENERALE BISCUIT	07/11/2023	245
552711	08/04/2024	SIRI	9	APPLE INC.	16/01/2024	245
552715	08/04/2024	EVAPLAN	5	URUFARMA S.A.	10/12/2023	34
552716	08/04/2024	MISTRAL	33	Compañía Pisquera de Chile S.A.	02/08/2023	221
552717	08/04/2024	MISTRAL ICE	33	Compañía Pisquera de Chile S.A.	02/08/2023	221
552720	08/04/2024	SIERRA MORENA	33 (S/D)	Compañía Pisquera de Chile S.A.	21/10/2023	221
552721	08/04/2024	CITIDIRECT BE	36	Citigroup Inc.	20/08/2023	194
552738	08/04/2024	CLUB VERDE SIMPLE Y SANO (mixta)	29 y 31	LEAL, MARCELO FELIX	28/10/2023	201
552741	08/04/2024	MBURUCUYÁ	33	ANTIGUA BODEGA STAGNARI S.A.	24/07/2023	189
552742	08/04/2024	TAMPICO	32 (S/D)	TAMPICO BEVERAGES, INC	27/08/2023	194
552744	08/04/2024	DUEVITE (mixta)	12	NTJ INVESTIMENTOS BRASIL LTDA	07/08/2023	34
552745	08/04/2024	SILVERCAP (mixta)	17	NTJ INVESTIMENTOS BRASIL LTDA	07/08/2023	34
552746	08/04/2024	REVY	5 (S/D)	REVIGAL S.A.	31/07/2023	144
552747	08/04/2024	TROMEN (mixta)	11 y 35	PARQUE ORIENTAL S.A.	01/11/2023	144
552748	08/04/2024	PAPER MATE	1 (S/D), 7 (S/D), 9 (S/D), 16 (S/D) y 20 (S/D)	SANFORD, L.P.	17/10/2023	144
552750	08/04/2024	(figurativa)	29 y 30	THE QUAKER OATS COMPANY	20/10/2023	201
552751	08/04/2024	TREMENDO	16, 35, 36, 38 y 41	SHOPPING CENTERS (URUGUAY) S.A.	09/12/2023	34
552752	08/04/2024	DIVINA 28 URUFARMA	5	URUFARMA S.A.	19/01/2024	34
552753	08/04/2024	QUAKER (mixta)	29 y 30	THE QUAKER OATS COMPANY	20/10/2023	201
552754	08/04/2024	CHEETOS SUPER HUELLAS	30	PEPSICO, INC.	27/10/2023	201

N° Exp	Resolución	Denominación	Clases	Titular	Vigencia	Ag.
552755	08/04/2024	LINZOR (mixta)	35 (S/D) y 36 (S/D)	ASESORIAS TACORA LTDA.	02/09/2023	34
552756	08/04/2024	DIVINA 21 URUFARMA	5	URUFARMA S.A.	19/01/2024	34
552757	08/04/2024	DIVINA 28 URUFARMA (mixta)	5	URUFARMA S.A.	19/01/2024	34
552758	08/04/2024	MICHELIN	14 (S/D), 20 (S/D), 21 (S/D), 24 (S/D), 25 (S/D), 28 (S/D) y 34 (S/D)	COMPAGNIE GENERALE DES ETABLISSEMENTS MICHELIN	29/10/2023	201
552760	08/04/2024	ALBALATEX	2 (S/D)	AKZO NOBEL ARGENTINA S.A.	31/08/2023	34
552761	08/04/2024	(figurativa)	1 (S/D), 3 (S/D), 4 (S/D), 35 (S/D), 36 (S/D), 37 (S/D), 39 (S/D) y 42 (S/D)	ConocoPhillips Company	15/12/2023	194
552763	08/04/2024	BRIKOL	2 (S/D)	AKZO NOBEL COATINGS INTERNATIONAL B.V.	14/08/2023	34
552766	08/04/2024	CONOCOPHILLIPS	1 (S/D), 3 (S/D), 4 (S/D), 35 (S/D), 36 (S/D), 37 (S/D), 39 (S/D) y 42 (S/D)	ConocoPhillips Company	15/12/2023	194
552767	08/04/2024	(figurativa)	3 (S/D), 6 (S/D), 16 (S/D) y 21 (S/D)	KIMBERLY-CLARK WORLDWIDE, INC.	08/08/2023	34
552770	08/04/2024	GOODRICH	7, 9, 11 y 12	GOODRICH CORPORATION	05/08/2023	34
552771	08/04/2024	(figurativa)	1 (S/D), 3 (S/D), 4 (S/D), 35 (S/D), 36 (S/D), 37 (S/D), 39 (S/D) y 42 (S/D)	ConocoPhillips Company	22/12/2023	194
552773	08/04/2024	INCALUX	2 (S/D)	PINTURAS INCA S.A.	31/08/2023	34
552774	08/04/2024	SOFLENS	9 (S/D)	BAUSCH & LOMB INCORPORATED	31/08/2023	34
552775	08/04/2024	OMEGA (mixta)	9 (S/D)	OMEGA SA (OMEGA AG)(OMEGA LTD.)	31/08/2023	34
552779	08/04/2024	HYAL-SYSTEM	5 (S/D)	Fidia Farmaceutici S.p.A	24/11/2023	136
552787	08/04/2024	TOTTUS EXPRESS (mixta)	35 (S/D) y 39 (S/D)	S.A.C.I. FALABELLA	21/08/2023	181

N° Exp	Resolución	Denominación	Clases	Titular	Vigencia	Ag.
552788	08/04/2024	GLEN GRANT	32 (S/D) y 33 (S/D)	Davide Campari-Milano N.V.	26/12/2023	34
552789	08/04/2024	SIBUR INTERNATIONAL S (mixta)	35 (S/D) y 39 (S/D)	PUBLIC JOINT STOCK COMPANY "SIBUR HOLDING"	20/01/2024	181
552797	08/04/2024	COLOSSAL REELS	9 (S/D) y 28 (S/D)	Light & Wonder, Inc.	19/09/2023	144
552798	08/04/2024	MICOSEP PROMOFARMA (mixta)	5	PROMOFARMA SRL	26/09/2023	19
552800	08/04/2024	VERRUXANE	5	PROMOFARMA SRL	20/10/2023	19
552803	08/04/2024	SHISEIDO BIO-PERFORMANCE (mixta)	3 (S/D)	SHISEIDO CO. LTD.	23/07/2023	34
553174	03/04/2024	BIOSET	5 y 10 (S/D)	MEDIC PLAST S.A.	02/09/2023	201
553180	04/04/2024	TRIEX GESTIÓN DE RESIDUOS	35 y 39	CELULOIDE S.A.	31/05/2023	34
553186	03/04/2024	VELCADE	5 (S/D)	MILLENNIUM PHARMACEUTICALS, INC.	18/08/2023	181
553192	03/04/2024	QUINTEC	5 (S/D)	Nissan Chemical Corporation	01/09/2023	216
553193	03/04/2024	DARATARD	1 (S/D)	GCP Applied Technologies Inc.	02/08/2023	216
553196	03/04/2024	EL SÚPER EXTRA (mixta)	36 y 41	BANCA DE CUBIERTA COLECTIVA DE QUINIÉLAS DE MONTEVIDEO	18/08/2023	245
553197	03/04/2024	MISIONES DE RENGO	33	VIÑA MISIONES DE RENGO S.A.	13/10/2023	181
553198	03/04/2024	(figurativa)	29	GRANJA POCHA S.A.	20/08/2023	245
553199	03/04/2024	FARMACITY	35	FARMCITY S.A.	21/08/2023	245
553200	03/04/2024	EDGE	4 (S/D)	CASTROL LIMITED	25/11/2023	245
553201	03/04/2024	ALIMENTA TU VIDA	29	GRANJA POCHA S.A.	20/08/2023	245
553202	03/04/2024	DANETTE	29 (S/D) y 30	COMPAGNIE GERVAIS DANONE	08/10/2023	245
553203	03/04/2024	DANONE	30	COMPAGNIE GERVAIS DANONE	01/10/2023	245
553204	03/04/2024	ACTIREGULARIS	29 (S/D)	COMPAGNIE GERVAIS DANONE	14/08/2023	245
553205	03/04/2024	DAN'UP	29 (S/D) y 30	COMPAGNIE GERVAIS DANONE	15/12/2023	245
553213	04/04/2024	COLGATE SLIM SOFT	21 (S/D)	COLGATE-PALMOLIVE COMPANY	22/10/2023	201
553214	04/04/2024	KOLYNOS ACCION TOTAL	3	COLGATE-PALMOLIVE COMPANY	22/10/2023	201
553217	03/04/2024	KWELL	5 (S/D)	Aspen Global Incorporated	12/10/2023	201
553218	04/04/2024	BIOCLIN	3 (S/D)	URUQUIM S.A.	29/10/2023	34
553219	04/04/2024	LUBRICENTRO	37	ADMINISTRACION NACIONAL DE	18/08/2023	201

N° Exp	Resolución	Denominación	Clases	Titular	Vigencia	Ag.
				COMBUSTIBLES ALCOHOL Y PORTLAND		
553223	04/04/2024	TROTANCAP (mixta)	41	ADMINISTRACION NACIONAL DE COMBUSTIBLES ALCOHOL Y PORTLAND	07/08/2023	201
553224	04/04/2024	LIDHERMA	3	LIDHERMA S.A.	22/08/2023	201
553231	04/04/2024	SHIFEI	3 (S/D)	BRAUNER LUKSENBURG, SILVIA	07/08/2023	189
553236	08/04/2024	HENDERSON & CIA	35	HENDERSON & CIA S.A.	28/08/2023	181
553237	08/04/2024	RETYLANE	3 (S/D) y 10 (S/D)	Galderma Holding S.A.	24/10/2023	201
553256	08/04/2024	VALDOXAN	5 (S/D)	BIOFARMA	09/10/2023	212
553265	08/04/2024	MI SOJA (mixta)	29 (S/D)	ETOSHA LTDA	09/08/2023	168
553267	08/04/2024	HIBTITER	5	Wyeth Holdings Corporation	29/10/2023	194
553268	08/04/2024	FIOCCHI	6 (S/D) y 13 (S/D)	Fiocchi Munizioni S.p.A.	16/09/2023	194
553269	08/04/2024	FIOCCHI	26 (S/D)	GIULIO FIOCCHI S.P.A.	16/09/2023	194
553270	08/04/2024	CONFIGARD	5	MERIAL	13/08/2023	227
553271	08/04/2024	FRONTLINE PLUS	5 (S/D)	MERIAL	01/09/2023	227
553273	08/04/2024	TERDAM	5	LABORATORIOS DISPERT S.A.	16/09/2023	201
553280	08/04/2024	MONTESSORI	16, 28 y 41	ALEJANDRO MARTIN PEREZ MELON	06/08/2023	94
553281	08/04/2024	VERECO	21 (S/D)	NEW DURALEX INTERNATIONAL	18/06/2023	34
553283	08/04/2024	CD CENTRO DENTAL (mixta)	10, 35 y 44	CENTRO DENTAL LTDA.	06/08/2023	245
553284	08/04/2024	(figurativa)	11 (S/D), 21 (S/D), 27 (S/D) y 35 (S/D)	THE POLO / LAUREN COMPANY, L.P.	02/12/2023	212
553285	08/04/2024	RALPH LAUREN	11 (S/D) y 35 (S/D)	THE POLO/LAUREN COMPANY, L.P.	02/12/2023	212
553295	08/04/2024	NADELLA	6 (S/D) y 7 (S/D)	NADELLA S.r.l.	14/03/2023	144
553296	08/04/2024	M (mixta)	9	MOTOROLA TRADEMARK HOLDINGS, LLC	15/10/2023	144
553297	08/04/2024	ICUS	5	ICU-VITA S.A.	31/08/2023	201
553305	08/04/2024	SERRANA	5	Rapenor s.a.	21/08/2023	172
553306	08/04/2024	WAMSUTTA	24	Overstock.com, Inc.	05/08/2023	194
553319	08/04/2024	GRUPO DE LA CAROLINA	35 y 43	José Fernando Coasini Hernandez	07/08/2023	101

N° Exp	Resolución	Denominación	Clases	Titular	Vigencia	Ag.
553327	08/04/2024	TORAY (mixta)	22 (S/D), 23 (S/D), 24 (S/D), 25 (S/D) y 28 (S/D)	TORAY KABUSHIKI KAISHA (TORAY INDUSTRIES, INC.)	07/02/2024	205
553339	08/04/2024	SANAL	1 (S/D), 3 (S/D) y 5 (S/D)	SALINS DU MIDI PARTICIPATIONS S.A.S	30/09/2023	181

Frasas Publicitarias Renovadas

N° Exp	Resolución	Denominación	Clases	Titular	Vigencia	Ag.
546143	14/03/2024	LA FELICIDAD VIENE EN TROCITOS	30	THE HERSHEY COMPANY	08/01/2023	34
547433	19/03/2024	MONSERRAT Y ECLAIR EFICACIA Y SEGURIDAD PARA RECOMENDAR	3, 5 y 16	LABORATORIOS MONSERRAT Y ECLAIR SOCIEDAD ANONIMA	29/07/2023	144
547434	19/03/2024	MONSERRAT Y ECLAIR SIENTANOS CERCA	3, 5 y 16	LABORATORIOS MONSERRAT Y ECLAIR SOCIEDAD ANONIMA	29/07/2023	144
547435	19/03/2024	EN MONSERRAT Y ECLAIR USTED PUEDE CONFIAR	3, 5 y 16	LABORATORIOS MONSERRAT Y ECLAIR SOCIEDAD ANONIMA	29/07/2023	144
547436	19/03/2024	MONSERRAT Y ECLAIR PREGÚNTELE A SU FARMACÉUTICO	3, 5 y 16	LABORATORIOS MONSERRAT Y ECLAIR SOCIEDAD ANONIMA	29/07/2023	144
547437	19/03/2024	MONSERRAT Y ECLAIR CONTROLA LA TOS	5 y 16	LABORATORIOS MONSERRAT Y ECLAIR SOCIEDAD ANONIMA	29/07/2023	144
548988	14/03/2024	CITA NOS ENCANTA LLEVARTE (mixta)	35 y 39	CITA S.A.	03/04/2023	219
550927	01/04/2024	EL DORADO SIEMPRE CERCA	35	POLAKOF Y CIA. S.A.	01/10/2023	94
551066	22/03/2024	MAMA PAPA PREFIERO AGUA	32	COMPAÑIA SALUS S.A.	29/11/2023	227
551565	15/03/2024	SIEMPRE CON VOS	38 y 41	MONTE CARLO T.V. S.A.	19/08/2023	144

TRANSFERENCIAS INSCRIPTAS***Transferencias de marcas, inscriptas***

N° Exp.	Resolución	Denominación	Clases	Titular	Dirección	Ag.
434354	02/04/2024	MAG1	1, 3 y 4	Warren Distribution, LLC	4500 Malone Road, 38118, Memphis, TN, E. U. DE NORTEAMERICA	201
440909	05/04/2024		3	HUGO BOSS TRADE MARK MANAGEMENT GMBH & CO. KG	Holy-Allee 3, 72555, Metzingen, ALEMANIA	201
444735	02/04/2024	PIMACO	16	PIMACO AUTOADESIVOS LTDA.	AVE. JOHN F. KENNEDY NO. 2.427, JARDIM LAR PARANÁ, CAMPO MOURÃO, PARANÁ, BRASIL	34
447696	02/04/2024	IMPRESA MATUTINA	40	IMPRESA MATUTINA S.A.	Yaro 1017, 11200, Montevideo, URUGUAY	216
447959	22/03/2024	NIDIB	5	SAN FAUSTO S.A.	COCHABAMBA 2525, C1252AAO, BUENOS AIRES, CAPITAL FEDERAL, ARGENTINA	201
450539	09/04/2024	LEÃO	30 y 32	TRANSPORTADORA MC LTDA.	Praia de Botafogo nº 374, 12º andar, CEP 22250-040, Botafogo, Rio de Janeiro, BRASIL	94
450941	05/04/2024	BOSS HUGO BOSS	9, 14, 18, 25, 28 y 34	HUGO BOSS TRADE MARK MANAGEMENT GMBH & CO. KG	Holy-Allee 3, 72555, Metzingen, ALEMANIA	201
450942	05/04/2024	HUGO BOSS	9, 14, 18, 25, 28 y 34	HUGO BOSS TRADE MARK MANAGEMENT	Holy-Allee 3, 72555, Metzingen, ALEMANIA	201

N° Exp.	Resolución	Denominación	Clases	Titular	Dirección	Ag.
				GMBH & CO. KG		
451602	05/04/2024	BOSS	9, 14, 18, 28 y 34	HUGO BOSS TRADE MARK MANAGEMENT GMBH & CO. KG	Holy-Allee 3, 72555, Metzingen, ALEMANIA	201
452595	21/03/2024	CANOPY	9	CAMBIUM (US) , L.L.C.	Unit B2 Linhay Business Park, Eastern Road, TQ13 7UP, Ashburton, Newton Abbot, Devon, GRAN BRETAÑA (REINO UNIDO)	194
452596	22/03/2024	CANOPY	9	CAMBIUM (US) , L.L.C.	Unit B2 Linhay Business Park, Eastern Road, TQ13 7UP, Ashburton, Newton Abbot, Devon, GRAN BRETAÑA (REINO UNIDO)	194
452832	22/03/2024	BRANSEC	5	SAN FAUSTO S.A.	COCHABAMBA 2525, C1252AAO, BUENOS AIRES, CAPITAL FEDERAL , ARGENTINA	201
453251	22/03/2024	BLAVIN	5	SAN FAUSTO S.A.	COCHABAMBA 2525, C1252AAO, BUENOS AIRES, CAPITAL FEDERAL , ARGENTINA	201
454327	22/03/2024	UBIDECAR	5	SAN FAUSTO S.A.	COCHABAMBA 2525, C1252AAO, BUENOS AIRES, CAPITAL FEDERAL , ARGENTINA	201
454328	22/03/2024	BIDECAR	5	SAN FAUSTO S.A.	COCHABAMBA 2525, C1252AAO, BUENOS AIRES, CAPITAL FEDERAL , ARGENTINA	201
456115	02/04/2024	BUFFALO TRACE	33	SAZERAC COMPANY, INC.	10101 Linn Station Road, Suite 400 , 40223, Louisville, Kentuchy, E. U. DE	245

N° Exp.	Resolución	Denominación	Clases	Titular	Dirección	Ag.
					NORTEAMERICA	
456116	02/04/2024		33	SAZERAC COMPANY, INC.	10101 Linn Station Road, Suite 400 , 40223, Louisville, Kentucky, E. U. DE NORTEAMERICA	18
456117	02/04/2024	EAGLE RARE	33	SAZERAC COMPANY, INC.	10101 Linn Station Road, Suite 400, Louisville, Kentucky, E. U. DE NORTEAMERICA	18
456396	21/03/2024	COLONEL E.H. TAYLOR	33	SAZERAC COMPANY, INC.	10101 Linn Station Road, Suite 400, 40223, Louisville, Kentucky, E. U. DE NORTEAMERICA	18
456397	21/03/2024	SAZERAC	33	SAZERAC COMPANY, INC.	10101 Linn Station Road, Suite 400, 40223, Louisville, Kentucky, E. U. DE NORTEAMERICA	18
456825	01/04/2024	FAMVIR	5	Novartis Pharma AG	Viaduktstrasse 3, 4051, BASEL, SUIZA	144
458015	02/04/2024	FINCA Y GRANJA CAMACHO	29, 30, 31 y 33	EDUARDO CANTON ETCHEBEHERE	Ruta 97 Km 262, Carmelo, Colonia, URUGUAY y Cerrito 420 esc. 509, MONTEVIDEO, URUGUAY	245
458015	08/04/2024	FINCA Y GRANJA CAMACHO	29, 30, 31 y 33	BANCHERO BANCHERO, MARÍA JOSÉ	Ruta 97 Km 262, Carmelo, Colonia, URUGUAY y Cerrito 420 esc. 509, MONTEVIDEO, URUGUAY	245
458016	08/04/2024	FINCA Y GRANJA NARBONA	29, 30, 31 y 33	BANCHERO BANCHERO, MARÍA JOSÉ	Cerrito 420 esc. 509, MONTEVIDEO, URUGUAY y Ruta 97 Km 262, Carmelo, Colonia, URUGUAY	245
458016	02/04/2024	FINCA Y GRANJA NARBONA	29, 30, 31 y 33	EDUARDO CANTON ETCHEBEHERE	Cerrito 420 esc. 509, MONTEVIDEO, URUGUAY y Ruta 97 Km 262, Carmelo, Colonia, URUGUAY	245

N° Exp.	Resolución	Denominación	Clases	Titular	Dirección	Ag.
467045	08/04/2024	BOSS HUGO BOSS	3	HUGO BOSS TRADE MARK MANAGEMENT GMBH & CO. KG	Holy-Allee 3, 72555, Metzingen, ALEMANIA	201
467296	05/04/2024	BOSS	25	HUGO BOSS TRADE MARK MANAGEMENT GMBH & CO. KG	Holy-Allee 3, 72555, Metzingen, ALEMANIA	201
467297	05/04/2024	HUGO HUGO BOSS	9, 14, 16, 18, 25 y 28	HUGO BOSS TRADE MARK MANAGEMENT GMBH & CO. KG	Holy-Allee 3, 72555, Metzingen, ALEMANIA	201
472272	05/04/2024	MONROE	12	TENNECO AUTOMOTIVE OPERATING COMPANY, INC.	15701 Technology Drive , 48168, Northville, Michigan , E. U. DE NORTEAMERICA	34
472401	05/04/2024	MONRO-MATIC	12	TENNECO AUTOMOTIVE OPERATING COMPANY INC.	15701 Technology Drive , 48168, Northville, Michigan , E. U. DE NORTEAMERICA	34
474280	05/04/2024	GAS-MATIC	12	TENNECO AUTOMOTIVE OPERATING COMPANY INC.	15701 Technology Drive , 48168, Northville, Michigan , E. U. DE NORTEAMERICA	34
480427	08/04/2024	SENSA-TRAC	12	TENNECO AUTOMOTIVE OPERATING COMPANY, INC.	15701 Technology Drive , 48168, Northville, Michigan , E. U. DE NORTEAMERICA	34
484259	04/04/2024	MASAPLUS	29	FLODDEN S.A.	CARLOS A. LOPEZ 7547 , 12400, MONTEVIDEO, URUGUAY	34
489758	05/04/2024	OESPECTRUM	12	TENNECO AUTOMOTIVE OPERATING	15701 Technology Drive , 48168, Northville, Michigan , E. U. DE NORTEAMERICA	34

N° Exp.	Resolución	Denominación	Clases	Titular	Dirección	Ag.
				COMPANY INC		
489872	05/04/2024	MONROE	12	Tenneco Automotive Operating Company Inc.	15701 Technology Drive , 48168, Northville, Michigan , E. U. DE NORTEAMERICA	34
491387	08/04/2024	RANCHO QUICK LIFT	12	TENNECO AUTOMOTIVE OPERATING COMPANY INC.	15701 Technology Drive , 48168, Northville, Michigan , E. U. DE NORTEAMERICA	34
494730	02/04/2024	E EXPENSE REDUCTION ANALYSTS	35	MONTGOMERY INVESTMENT CO S.A.	Suite 24, 40 Churchill Square, Kings Hill WEST MALLING , ME19 4YU, KENT , GRAN BRETAÑA (REINO UNIDO)	245
495318	08/04/2024	HUGO BOSS	3	HUGO BOSS TRADEMARK MANAGEMENT GMBH & CO. KG	Holy-Allee 3, 72555, Metzingen, ALEMANIA	201
495597	02/04/2024	E	35	MONTGOMERY INVESTMENT CO S.A.	Suite 24, 40 Churchill Square, Kings Hill WEST MALLING , ME19 4YU, KENT , GRAN BRETAÑA (REINO UNIDO)	245
495930	02/04/2024	PREMIUM AVICOLAS DEL OESTE	29 y 43	SOLSIN S.A.	Cuneo Perinetti 1263, MONTEVIDEO, URUGUAY y Belastiqui 1441, MONTEVIDEO, URUGUAY	219
496638	02/04/2024	BALIARDA	1, 3 y 5	SAN FAUSTO S.A.	COCHABAMBA 2525, C1252AAO, BUENOS AIRES, CAPITAL FEDERAL , ARGENTINA	201
498867	02/04/2024	RAGASCO	4, 6, 20, 35 y 40	Hexagon Technology AS	P.O. Box 50, 2831, Raufoss, NORUEGA	179
502181	08/04/2024	BOSS	3	HUGO BOSS TRADE MARK MANAGEMENT GMBH & CO. KG	Holy-Allee 3, 72555, Metzingen, ALEMANIA	201

N° Exp.	Resolución	Denominación	Clases	Titular	Dirección	Ag.
502927	08/04/2024	HUGO HUGO BOSS	3	HUGO BOSS TRADE MARK MANAGEMENT GMBH & CO. KG	Holy-Allee 3, 72555, Metzingen, ALEMANIA	201
503227	08/04/2024	HUGO	3	Hugo Boss Trade Mark Management Gmbh & Co. KG	Holy-Allee 3, 72555, Metzingen, ALEMANIA	201
509598	22/03/2024	ELECTROLOGIXS	9	ALSTOM Transport Technologies	48 rue Albert Dhalenne, saint-Ouen, 93400, -, -, FRANCIA	165
510292	08/04/2024	BOSS BOTTLED	3	HUGO BOSS TRADE MARK MANAGEMENT GMBH & CO. KG	Holy-Allee 3, 72555, Metzingen, ALEMANIA	201
517702	22/03/2024	EFEKTA	39, 41 y 42	SIGNUM INTERNATIONAL AG	22 Chelsea Manor Street, SW3 5RL , Londres , GRAN BRETAÑA (REINO UNIDO)	201
517818	05/04/2024	RANCHO	12	TENNECO AUTOMOTIVE OPERATING COMPANY INC.	15701 Technology Drive , 48168, Northville, Michigan , E. U. DE NORTEAMERICA	34
517835	03/04/2024	HEY DUDE	25	Full Fortune Intellectual Limited	11 North Buona Vista Drive 04-07, The Metropolis, SINGAPUR	212
519849	02/04/2024	CYCO	1	SJ ENTERPRISES PTY LTD	3993 Howard Hughes Parkway, Suite 250, 89169, Las Vegas, Nevada, E. U. DE NORTEAMERICA	34
520395	22/03/2024	APTIS	9, 12 y 39	ALSTOM Transport Technologies	48 rue Albert Dhalenne, saint-Ouen, 93400, -, -, FRANCIA	144
522932	08/04/2024	BOSS	9, 14, 16, 18, 24, 25 y 35	HUGO BOSS Trade Mark Management GmbH & Co. KG	Holy-Allee 3, 72555, Metzingen, ALEMANIA	201
522933	08/04/2024	HUGO BOSS	16 y 35	HUGO BOSS Trade Mark Management GmbH & Co. KG	Holy-Allee 3, 72555, Metzingen, ALEMANIA	201

N° Exp.	Resolución	Denominación	Clases	Titular	Dirección	Ag.
522934	08/04/2024	BOSS	12, 18, 21, 25 y 35	HUGO BOSS Trade Mark Management GmbH & Co. KG	Holy-Allee 3, 72555, Metzingen, ALEMANIA	201
530320	08/04/2024	HUGO	9, 14, 16, 18, 25 y 35	HUGO BOSS Trade Mark Management GmbH & Co. KG	Holy-Allee 3, 72555, Metzingen, ALEMANIA	201
538288	02/04/2024	PLUNA	39	Citum S.A.	1309 Coffeen Avenue Ste 1200 Sheridan , 82801 , WY , E. U. DE NORTEAMERICA	220
540567	08/04/2024	JUST DIFFERENT	3	HUGO BOSS TRADE MARK MANAGEMENT GMBH & CO. KG	Holy-Allee 3, 72555, Metzingen, ALEMANIA	201
540789	08/04/2024	BOSS HUGO BOSS	35	HUGO BOSS TRADE MARK MANAGEMENT GMBH & CO. KG	Holy-Allee 3, 72555, Metzingen, ALEMANIA	201
549541	05/04/2024	HAMMERHEAD	9, 41 y 42	SRAM-SP2, Inc.	100 West Fulton Market, 4th Floor, 60607, ILLINOIS, E. U. DE NORTEAMERICA	136
549541	02/04/2024	HAMMERHEAD	9, 41 y 42	HAMMERHEAD NAVIGATION INC.	100 West Fulton Market, 4th Floor, 60607, ILLINOIS, E. U. DE NORTEAMERICA	136
550969	02/04/2024	SUDAMERIS	36	Citum S.A.	1309 Coffeen Avenue Ste 1200 Sheridan , 82801 , WY , E. U. DE NORTEAMERICA	220
552723	09/04/2024	HALDOL	5	JANSSEN PHARMACEUTICA N.V.	Landis + Gyr-Strasse 1, c/o LacMont AG, 6300, ZUG, SUIZA	194

CAMBIOS DE NOMBRE INSCRIPTOS*Cambios de nombre de marcas, incriptos*

N° Exp.	Resolución	Denominación	Clases	Titular	Dirección	Ag.
426679	02/04/2024	TRINSEO	1	STYRON EUROPE GMBH	Gwattstrasse 15, 8808 , Pfaeffikon, SUIZA	201
437939	01/04/2024	PRODUCT OF ITALY,CIPRIANI R FOOD VENEZIA 1931, TAGLIOLINI - EXTRA THIN EGG PASTA, EXPERIENCE OUR RESTAURANTS AT HOME, CIPRIANIS RECIPE INSIDE, PRODUCT OF ITALY,CIPRIANI R FOOD VENEZIA 1931, TAGLIOLINI - EXTRA THIN EGG PASTA, PRODUCT OF ITALY,CIPRIANI R FOOD VENEZIA 1931, TAGLIOLINI- EXTRA THIN EGG PASTA, EXPERIENCE OUR RESTAURANTS AT HOME, CIPRIANIS RECIPE INSIDE, PRODUCT OF ITALY,CIPRIANI R FOOD VENEZIA 1931, TAGLIOLINI - EXTRA THIN EGG PASTA, CIPRIANI R FOOD VENEZIA 1931,	30	ALTUNIS TRADING GESTÃO E SERVIÇOS LDA	Avenida Arriaga, número 73, 1 andar, sala 113, 9000-0600, Funchal, Madeira, PORTUGAL	212

N° Exp.	Resolución	Denominación	Clases	Titular	Dirección	Ag.
		TAGLIOLINI -EXTRA THIN EGG PASTA, PRODUCT OF ITALY EXPERIENCE OUR RESTAURANTS AT HOME, CIPRIANIS RECIPE INSIDE, PRODUCT OF ITALY,CIPRIANI R FOOD VENEZIA 1931, TAGLIOLINI - EXTRA THIN EGG PASTA, CIPRIANI R FOOD VENEZIA 1931, TAGLIOLINI - EXTRA THIN EGG PASTA, PRODUCT OF ITALY CIPRIANI R FOOD VENEZIA 1931				
437940	01/04/2024	PRODUCT OF ITALY, CIPRIANI R FOOD VENEZIA 1931, TAGLIARDI EXTRA THIN EGG PASTA, EXPERIENCE OUR RESTAURANTS AT HOME, CIPRIANI'S RECIPE INSIDE, PRODUCT OF ITALY, CIPRIANI R FOOD VENEZIA 1931, TAGLIARDI EXTRA THIN EGG PASTA, PRODUCT OF ITALY, CIPRIANI R FOOD VENEZIA 1931, TAGLIARDI EXTRA THIN EGG PASTA, EXPERIENCE OUR RESTAURANTS AT	30	ALTUNIS TRADING GESTÃO E SERVIÇOS LDA	Avenida Arriaga, número 73, 1 andar, sala 113, 9000-0600, Funchal, Madeira, PORTUGAL	212

N° Exp.	Resolución	Denominación	Clases	Titular	Dirección	Ag.
		HOME, CIPRIANI'S RECIPE INSIDE, PRODUCT OF ITALY, CIPRIANI R FOOD VENEZIA 1931, TAGLIARDI EXTRA THIN EGG PASTA, CIPRIANI R FOOD VENEZIA 1931, TAGLIARDI EXTRA THIN EGG PASTA, PRODUCT OF ITALY EXPERIENCE OUR RESTAURANTS AT HOME, CIPRIANI'S RECIPE INSIDE, PRODUCT OF ITALY, CIPRIANI R FOOD VENEZIA 1931, TAGLIARDI EXTRA THIN EGG PASTA, CIPRIANI R FOOD VENEZIA 1931, TAGLIARDI EXTRA THIN EGG PASTA, PRODUCT OF ITALY CIPRIANI R FOOD VENEZIA 1931				
437941	03/04/2024	PRODUCT OF ITALY,CIPRIANI R FOOD VENEZIA 1931, PAPPARDELLE - EXTRA THIN EGG PASTA. EXPERIENCE OUR RESTAURANTS AT HOME, CIPRIANIS RECIPE INSIDE, PRODUCT OF ITALY,CIPRIANI R FOOD VENEZIA 1931, PAPPARDELLE- EXTRA	30	ALTUNIS TRADING GESTÃO E SERVIÇOS LDA	9000-050, Funchal, Madeira, PORTUGAL	212

N° Exp.	Resolución	Denominación	Clases	Titular	Dirección	Ag.
		<p>THIN EGG PASTA, PRODUCT OF ITALY,CIPRIANI R FOOD VENEZIA 1931, PAPPARDELLE - EXTRA THIN EGG PASTA. EXPERIENCE OUR RESTAURANTS AT HOME, CIPRIANIS RECIPE INSIDE, PRODUCT OF ITALY,CIPRIANI R FOOD VENEZIA 1931, PAPPARDELLE - EXTRA THIN EGG PASTA, CIPRIANI R FOOD VENEZIA 1931, PAPPARDELLE -EXTRA THIN EGG PASTA, PRODUCT OF ITALY. EXPERIENCE OUR RESTAURANTS AT HOME, CIPRIANIS RECIPE INSIDE, PRODUCT OF ITALY,CIPRIANI R FOOD VENEZIA 1931, PAPPARDELLE - EXTRA THIN EGG PASTA, CIPRIANI R FOOD VENEZIA 1931, PAPPARDELLE - EXTRA THIN EGG PASTA, PRODUCT OF ITALY. CIPRIANI R FOOD VENEZIA 1931</p>				

N° Exp.	Resolución	Denominación	Clases	Titular	Dirección	Ag.
437942	03/04/2024	<p>DELICATE ZERO CHOLESTEROL, CIPRIANI R FOOD VENEZIA 1931, TAGLIOLINI- EXTRA THIN DURUM WHEAT AND EGG WHITE, SPECIALTY FOOD. DELICATE CHOLESTEROL ZERO CHOLESTEROL, CIPRIANI R FOOD VENEZIA 1931, TAGLIOLINI DI GRANO DURO E ALBUME D' UOVO EXTRA SOTTILI SPECIALITÀ ALIMENTARE, DELICATE ZERO CHOLESTEROL, CIPRIANI R FOOD VENEZIA 1931, TAGLIOLINI- EXTRA THIN DURUM WHEAT AND EGG WHITE, SPECIALTY FOOD. DELICATE CHOLESTEROL ZERO CHOLESTEROL, CIPRIANI R FOOD VENEZIA 1931, TAGLIOLINI DI GRANO DURO E ALBUME D' UOVO EXTRA SOTTILI SPECIALITÀ ALIMENTARE, CIPRIANI R FOOD VENEZIA 1931, TAGLIOLINI- EXTRA THIN DURUM WHEAT AND EGG WHITE, SPECIALTY FOOD.</p>	30	<p>ALTUNIS TRADING GESTÃO E SERVIÇOS LDA</p>	<p>Avenida Arriaga, número 73, 1 andar, sala 113, 9000-0600, Funchal, Madeira, PORTUGAL</p>	212

N° Exp.	Resolución	Denominación	Clases	Titular	Dirección	Ag.
		DELICATE CHOLESTEROL ZERO CHOLESTEROL, CIPRIANI R FOOD VENEZIA 1931, TAGLIOLINI DI GRANO DURO E ALBUME D' UOVO EXTRA SOTTILI SPECIALITÁ ALIMENTARE,CIPRIANI R FOOD VENEZIA 1931, TAGLIOLINI- EXTRA THIN DURUM WHEAT AND EGG WHITE, SPECIALTY FOOD. CIPRIANI R FOOD VENEZIA 1931				
438420	03/04/2024	CIPRIANI R FOOD VENEZIA 1931 TAGLIOLINI - EXTRA THIN EGG PASTA WITH TOMATO CIPRIANI R FOOD VENEZIA 1931 TAGLIOLINI ALL'UOVO EXTRA SOTTILI CON POMODORO CIPRIANI R FOOD VENEZIA 1931 TAGLIOLINI ALL'UOVO EXTRA SOTTILI WITH TOMATO TAGLIOLINI EXTRA THIN EGG PASTA WITH TOMATO CIPRIANI FOOD	30	ALTUNIS TRADING GESTÃO E SERVIÇOS LDA	Avenida Arriaga, número 73, 1 andar, sala 113, 9000-0600, Funchal, Madeira, PORTUGAL	212
441947	01/04/2024	KBASIGI	9 y 42	KASPERSKY LAB ZAO	39A/2 Rusia. Leningradskoe Shosse, 125212, MOSCÚ, FEDERACION DE RUSIA	193

N° Exp.	Resolución	Denominación	Clases	Titular	Dirección	Ag.
441948	01/04/2024	KABASIJJ	9 y 42	KASPERSKY LAB ZAO	39A/2 Rusia. Leningradskoe Shosse, 125212, MOSCÚ, FEDERACION DE RUSIA	193
443655	04/04/2024	PURO TRATO	31	J.A TEIXEIRA VETERINÁRIA	Avenida do Comércio, 1201, Barrio Santa Fé, Santo Augusto, Rio Grande do Sul, BRASIL	34
445689	01/04/2024	SANATORIO SAN CARLOS	44	ASISTENCIAL MEDICA COOPERATIVA DE MALDONADO	Av. Andrés Ceberio 649, Maldonado, URUGUAY	101
448483	05/04/2024		7, 9, 11 y 37	METSO PAPER, INC.	Keilasatama 5, 02150, Espoo, FINLANDIA	245
449676	04/04/2024	SOMFY	9	SOMFY SAS	50, Avenue Du Nouveau Monde, 74300, Cluses, FRANCIA	144
453653	04/04/2024	DMG	5	ERNST MÜHLBAUER GMBH & CO. KG	22547, Hamburgo, ALEMANIA	240
458195	04/04/2024	SOMFY	7 y 9	SOMFY SAS	50, Avenue Du Nouveau Monde, 74300, Cluses, FRANCIA	144
459981	02/04/2024	FAVRE LEUBA	14	FAVRE LEUBA AG	Gotthardstrasse 3, CH-6300, Zug, SUIZA	94
462246	04/04/2024	ZETASCALE	9, 35, 41, 42 y 45	SanDisk Enterprise IP LLC	951 SanDisk Drive, 95035, Milpitas, California, E. U. DE NORTEAMERICA	212
467026	09/04/2024	XPO	36 y 39	XPO LOGISTICS, INC.	Five Greenwich Office Park, 06831, Greenwich, Connecticut, E. U. DE NORTEAMERICA	194
474251	05/04/2024	ISMO	5	RIEMSER PHARMA GMBH	Hohenzollerndamm 150 – 151, 14199 , Berlin, ALEMANIA	201
490445	01/04/2024	DELSAH	12	Zhejiang Tieliu Clutch Co., Ltd	No.958 North Donghu Road, Yuhang Economic Development Zone, Hangzhou City, Zhejiang Province, CHINA	144
496486	05/04/2024	PAN AMERICAN ENERGY	4, 37, 39, 40 y 42	PAN AMERICAN ENERGY, S.L.	Arbea Campus Empresarial, Edificio 1, Ctra. Fuencarral a	94

N° Exp.	Resolución	Denominación	Clases	Titular	Dirección	Ag.
					Alcobendas, M603, 3,8 Km, Alcobendas, 28108, Madrid, Madrid, ESPAÑA	
498573	05/04/2024	PAN AMERICAN ENERGY	4, 37, 39, 40 y 42	PAN AMERICAN ENERGY, S.L.	Arbea Campus Empresarial, Edificio 1, Ctra. Fuencarral a Alcobendas, M603, 3,8 Km, Alcobendas, 28108, Madrid, Madrid, ESPAÑA	94
498574	05/04/2024	PAE PAN AMERICAN ENERGY	4, 37, 39, 40 y 42	PAN AMERICAN ENERGY, S.L.	Arbea Campus Empresarial, Edificio 1, Ctra. Fuencarral a Alcobendas, M603, 3,8 Km, Alcobendas, 28108, Madrid, Madrid, ESPAÑA	94
539203	04/04/2024	PAE PAN AMERICAN ENERGY	35 y 43	PAN AMERICAN ENERGY, S.L.	Arbea Campus Empresarial, Edificio 1, Ctra. Fuencarral a Alcobendas, M603, 3,8 Km, Alcobendas, 28108, Madrid, Madrid, ESPAÑA	94

Cambios de nombre de patentes, inscriptos

N° Exp.	Resolución	Denominación	Clases	Titular	Dirección	Ag.
037371	22/03/2024			SUZANO PAPEL E CELULOSE S.A.		18

CAMBIOS DE DOMICILIO INSCRIPTOS*Cambios de domicilio de marcas, inscriptos*

N° Exp.	Resolución	Denominación	Clases	Titular	Dirección	Ag.
408737	05/04/2024	ARKO	3	EVYAP SABUN YAG GLISERIN SANAYI VE TICARET ANONIM SIRKETI	Istanbul Deri Organize Sanayi Bölgesi Güderi Caddesi, N:1, X- 1, Özel Parsel Tuzla , Istanbul, TURQUIA	34
411358	22/03/2024	DELIZIA URUGUAY COUSA	29, 30, 31 y 32	COMPANHIA OLEAGINOSA URUGUAYA S.A.	Luis Batlle Berres 5327, Montevideo, URUGUAY	144
426148	08/04/2024	BALANCED BODY	28	BALANCED BODY, INC	5909 88th Street, 95928-1111, Sacramento, California, E. U. DE NORTEAMERICA	94
426679	04/04/2024	TRINSEO	1	Trinseo Europe GmbH	Gwattstrasse 15, 8808 , Pfaeffikon, SUIZA	201
428531	02/04/2024	MILHRS	18	ANA LAURA AEMILIUS BEREZAN	Joaquín Velazco 3154 apto 506, Montevideo, URUGUAY	
429056	05/04/2024	SANUK	18, 25 y 35	DECKERS OUTDOOR CORPORATION	250 Coromar Drive Goleta, 93117 , California, E. U. DE NORTEAMERICA	181
431935	05/04/2024	WISE UP	16 y 41	WISER EDUCAÇÃO S.A.	Avenida Presidente Getúlio Vargas, 3812, Água Verde, 80240-041, Curitiba, Parana, BRASIL	94
437939	02/04/2024	PRODUCT OF ITALY,CIPRIANI R FOOD VENEZIA 1931, TAGLIOLINI - EXTRA THIN EGG PASTA, EXPERIENCE OUR RESTAURANTS AT HOME,	30	ALTUNIS - TRADING, GESTÃO E SERVIÇOS, SOCIEDADE UNIPESSOAL, LDA	Avenida Arriaga, número 73, 1 andar, sala 113, 9000-0600, Funchal, Madeira, PORTUGAL	212

N° Exp.	Resolución	Denominación	Clases	Titular	Dirección	Ag.
		CIPRIANIS RECIPE INSIDE, PRODUCT OF ITALY,CIPRIANI R FOOD VENEZIA 1931, TAGLIOLINI - EXTRA THIN EGG PASTA, PRODUCT OF ITALY,CIPRIANI R FOOD VENEZIA 1931, TAGLIOLINI- EXTRA THIN EGG PASTA, EXPERIENCE OUR RESTAURANTS AT HOME, CIPRIANIS RECIPE INSIDE, PRODUCT OF ITALY,CIPRIANI R FOOD VENEZIA 1931, TAGLIOLINI - EXTRA THIN EGG PASTA, CIPRIANI R FOOD VENEZIA 1931, TAGLIOLINI -EXTRA THIN EGG PASTA, PRODUCT OF ITALY EXPERIENCE OUR RESTAURANTS AT HOME, CIPRIANIS RECIPE INSIDE, PRODUCT OF ITALY,CIPRIANI R FOOD VENEZIA 1931, TAGLIOLINI - EXTRA THIN EGG PASTA, CIPRIANI R FOOD VENEZIA 1931, TAGLIOLINI - EXTRA THIN EGG PASTA,				

N° Exp.	Resolución	Denominación	Clases	Titular	Dirección	Ag.
		PRODUCT OF ITALY CIPRIANI R FOOD VENEZIA 1931				
437940	03/04/2024	PRODUCT OF ITALY, CIPRIANI R FOOD VENEZIA 1931, TAGLIARDI EXTRA THIN EGG PASTA, EXPERIENCE OUR RESTAURANTS AT HOME, CIPRIANI'S RECIPE INSIDE, PRODUCT OF ITALY, CIPRIANI R FOOD VENEZIA 1931, TAGLIARDI EXTRA THIN EGG PASTA, PRODUCT OF ITALY, CIPRIANI R FOOD VENEZIA 1931, TAGLIARDI EXTRA THIN EGG PASTA, EXPERIENCE OUR RESTAURANTS AT HOME, CIPRIANI'S RECIPE INSIDE, PRODUCT OF ITALY, CIPRIANI R FOOD VENEZIA 1931, TAGLIARDI EXTRA THIN EGG PASTA, CIPRIANI R FOOD VENEZIA 1931, TAGLIARDI EXTRA THIN EGG PASTA, PRODUCT OF ITALY EXPERIENCE OUR RESTAURANTS AT HOME, CIPRIANI'S RECIPE INSIDE, PRODUCT OF ITALY, CIPRIANI R FOOD	30	ALTUNIS - TRADING, GESTÃO E SERVIÇOS, SOCIEDADE UNIPESSOAL, LDA	Avenida Arriaga, número 73, 1 andar, sala 113, 9000-0600, Funchal, Madeira, PORTUGAL	212

N° Exp.	Resolución	Denominación	Clases	Titular	Dirección	Ag.
		VENEZIA 1931, TAGLIARDI EXTRA THIN EGG PASTA, CIPRIANI R FOOD VENEZIA 1931, TAGLIARDI EXTRA THIN EGG PASTA, PRODUCT OF ITALY CIPRIANI R FOOD VENEZIA 1931				
437941	03/04/2024	PRODUCT OF ITALY,CIPRIANI R FOOD VENEZIA 1931, PAPPARDELLE - EXTRA THIN EGG PASTA. EXPERIENCE OUR RESTAURANTS AT HOME, CIPRIANIS RECIPE INSIDE, PRODUCT OF ITALY,CIPRIANI R FOOD VENEZIA 1931, PAPPARDELLE- EXTRA THIN EGG PASTA, PRODUCT OF ITALY,CIPRIANI R FOOD VENEZIA 1931, PAPPARDELLE - EXTRA THIN EGG PASTA. EXPERIENCE OUR RESTAURANTS AT HOME, CIPRIANIS RECIPE INSIDE, PRODUCT OF ITALY,CIPRIANI R FOOD VENEZIA 1931, PAPPARDELLE - EXTRA THIN EGG PASTA,	30	ALTUNIS TRADING GESTÃO E SERVIÇOS LDA	9000-050, Funchal, Madeira, PORTUGAL	212

N° Exp.	Resolución	Denominación	Clases	Titular	Dirección	Ag.
		CIPRIANI R FOOD VENEZIA 1931, PAPPARDELLE -EXTRA THIN EGG PASTA, PRODUCT OF ITALY. EXPERIENCE OUR RESTAURANTS AT HOME, CIPRIANIS RECIPE INSIDE, PRODUCT OF ITALY,CIPRIANI R FOOD VENEZIA 1931, PAPPARDELLE - EXTRA THIN EGG PASTA, CIPRIANI R FOOD VENEZIA 1931, PAPPARDELLE - EXTRA THIN EGG PASTA, PRODUCT OF ITALY. CIPRIANI R FOOD VENEZIA 1931				
437942	03/04/2024	DELICATE ZERO CHOLESTEROL, CIPRIANI R FOOD VENEZIA 1931, TAGLIOLINI- EXTRA THIN DURUM WHEAT AND EGG WHITE, SPECIALTY FOOD. DELICATE CHOLESTEROL ZERO CHOLESTEROL, CIPRIANI R FOOD VENEZIA 1931, TAGLIOLINI DI GRANO DURO E ALBUME D' UOVO EXTRA SOTTILI SPECIALITÁ	30	ALTUNIS TRADING GESTÃO E SERVIÇOS LDA	Avenida Arriaga, número 73, 1 andar, sala 113, 9000-0600, Funchal, Madeira, PORTUGAL	212

N° Exp.	Resolución	Denominación	Clases	Titular	Dirección	Ag.
		<p>ALIMENTARE, DELICATE ZERO CHOLESTEROL, CIPRIANI R FOOD VENEZIA 1931, TAGLIOLINI- EXTRA THIN DURUM WHEAT AND EGG WHITE, SPECIALTY FOOD. DELICATE CHOLESTEROL ZERO CHOLESTEROL, CIPRIANI R FOOD VENEZIA 1931, TAGLIOLINI DI GRANO DURO E ALBUME D' UOVO EXTRA SOTTILI SPECIALITÀ</p> <p>ALIMENTARE,CIPRIANI R FOOD VENEZIA 1931, TAGLIOLINI- EXTRA THIN DURUM WHEAT AND EGG WHITE, SPECIALTY FOOD. DELICATE CHOLESTEROL ZERO CHOLESTEROL, CIPRIANI R FOOD VENEZIA 1931, TAGLIOLINI DI GRANO DURO E ALBUME D' UOVO EXTRA SOTTILI SPECIALITÀ</p> <p>ALIMENTARE,CIPRIANI R FOOD VENEZIA 1931, TAGLIOLINI- EXTRA THIN DURUM WHEAT AND EGG WHITE, SPECIALTY FOOD. CIPRIANI R FOOD</p>				

N° Exp.	Resolución	Denominación	Clases	Titular	Dirección	Ag.
		VENEZIA 1931				
437944	21/03/2024	CIPRIANI R FOOD VENEZIA 1931, TAGLIOLINI - EXTRA THIN EGG PASTA, CIPRIANI R FOOD VENEZIA 1931, TAGLIOLINI- ALL'UOVO EXTRA SOTTILI, CIPRIANI R FOOD VENEZIA 1931, TAGLIOLONI- EXTRA THIN EGG PASTA, CIPRIANI R FOOD VENEZIA 1931, TAGLIOLINI- ALL'UOVO EXTRA SOTTILI, CIPRIANI R FOOD VENEZIA 1931, TAGLIOLONI- EXTRA THIN EGG PASTA, CIPRIANI R FOOD VENEZIA 1931, TAGLIOLINI- ALL'UOVO EXTRA SOTTILI, CIPRIANI R FOOD VENEZIA 1931, TAGLIOLONI- EXTRA THIN EGG PASTA, CIPRIANI R FOOD VENEZIA 1931, TAGLIOLINI- ALL'UOVO EXTRA SOTTILI, CIPRIANI R FOOD VENEZIA 1931, TAGLIOLONI- EXTRA THIN EGG PASTA, CIPRIANI R FOOD VENEZIA 1931	30	ALTUNIS - TRADING, GESTÃO E SERVIÇOS, SOCIEDADE UNIPESSOAL, LDA.	Avenida Arriaga, número 73, 1 andar, sala 113, 9000-0600, Funchal, Madeira, PORTUGAL	212
438420	03/04/2024	CIPRIANI R FOOD VENEZIA 1931 TAGLIOLINI - EXTRA THIN EGG PASTA WITH TOMATO CIPRIANI R FOOD VENEZIA 1931	30	ALTUNIS TRADING GESTÃO E SERVIÇOS LDA	Avenida Arriaga, número 73, 1 andar, sala 113, 9000-0600, Funchal, Madeira, PORTUGAL	212

N° Exp.	Resolución	Denominación	Clases	Titular	Dirección	Ag.
		TAGLIOLINI ALL'UOVO EXTRA SOTTILI CON POMODORO CIPRIANI R FOOD VENEZIA 1931 TAGLIOLINI ALL'UOVO EXTRA SOTTILI WITH TOMATO TAGLIOLINI EXTRA THIN EGG PASTA WITH TOMATO CIPRIANI FOOD				
441947	05/04/2024	KABASIGI	9 y 42	AO Kaspersky Lab	39A/2 Rusia. Leningradskoe Shosse, 125212, MOSCÚ, FEDERACION DE RUSIA	193
441948	05/04/2024	KABASIJI	9 y 42	AO Kaspersky Lab	39A/2 Rusia. Leningradskoe Shosse, 125212, MOSCÚ, FEDERACION DE RUSIA	193
443971	02/04/2024	TORERO	29	COMPANIA OLEAGINOSA URUGUAYA S.A.	Luis Batlle Berres 5327, Montevideo, Montevideo, URUGUAY	144
444735	01/04/2024	PIMACO	16	PIMACO AUTOADESIVOS LTDA.	AVE. JOHN F. KENNEDY NO. 2.427, JARDIM LAR PARANÁ , CAMPO MOURÃO, PARANÁ, BRASIL	34
445547	05/04/2024	HARAS LUJAN DEL MILAGRO	31, 41, 43 y 44	DALED S.A.	Clemente Pradines 1795, Montevideo, URUGUAY	194
447543	02/04/2024	CLARO SPORTS	9, 35, 38 y 41	CLARO S.A.	Rua Henri Dunant, 780- Torre B (16° andar), Santo Amaro, 04709-110, São Paulo, BRASIL	181
447564	08/04/2024	MISS 15	16, 35, 38 y 41	MISS 15 S.R.L.	Juan Carlos Gómez 1445 of. 301, Montevideo, URUGUAY	94
447733	05/04/2024	DK DAKOTA	43	DIEGO ALEJANDRO PEREZ	Ejido 1025 ap 206, Montevideo, URUGUAY	94
447831	05/04/2024	FAMOUSLY EFFECTIVE	35	GREY GLOBAL GROUP LLC	3 World Trade Center, 175 Greenwich Street, 10007, New	194

N° Exp.	Resolución	Denominación	Clases	Titular	Dirección	Ag.
					York, NY, E. U. DE NORTEAMERICA	
447926	04/04/2024	GMO	36	GRANTHAM, MAYO, VAN OTTERLOO & CO., LLC	53 State Street, 02110, Boston, Massachusetts, E. U. DE NORTEAMERICA	194
448337	04/04/2024	WEINBRENNER	18, 25 y 35	BATA BRANDS S.A.	Avenue d'Ouchy 61, 1006 , Lausanne, SUIZA	201
448450	04/04/2024	SMYTHSON	3, 9, 14, 16, 18 y 35	FRANK SMYTHSON LIMITED	257a Pavilion Road , SW1X 0BP, London, GRAN BRETAÑA (REINO UNIDO)	245
448475	01/04/2024	SURA AHORRO DOLAR FONDO DE INVERSIÓN	36	GRUPO DE INVERSIONES SURAMERICANA S.A.	Carrera 43 A No. 5 A-113 Pisos 13, 14 y 15 Edificio One Plaza, Medellin, Antioquía, COLOMBIA	205
448483	08/04/2024		7, 9, 11 y 37	Valmet Technologies, Inc	Keilasatama 5, 02150, Espoo, FINLANDIA	245
448500	05/04/2024	CITIFX PULSE	36	CITIGROUP INC.	388 Greenwich Street, 10013, New York, New York, E. U. DE NORTEAMERICA	194
448724	05/04/2024	MACRON	25	MACRON S.P.A.	Via Giulio Pastore 57, 40053, Frazione Crespellano, Bologna, ITALIA	34
449394	05/04/2024	TMNT	30	VIACOM OVERSEAS HOLDINGS C.V.	NDSM Plein 6, 1033 , Amsterdam, WB , PAISES BAJOS	194
449798	04/04/2024	RHYTHMFINDER	10	BIOSENSE WEBSTER, INC.	31 Technology Drive, Suite 200, 92618, Irvine, CA, E. U. DE NORTEAMERICA	194
450293	04/04/2024	TPA THE PRIVATE ADVISORS	36	THE PRIVATE ADVISORS S.A.	Dr. Luis Bonavita 1294, Oficina 1039, Montevideo, URUGUAY	94
450315	05/04/2024	CONFIDENSE	10	BIOSENSE WEBSTER, INC.	31 Technology Drive, Suite 200, 92618, Irvine, CA, E. U. DE NORTEAMERICA	194
452471	04/04/2024	MY PASSPORT	9	WESTERN DIGITAL	5601 Great Oaks Parkway, 95119	212

N° Exp.	Resolución	Denominación	Clases	Titular	Dirección	Ag.
				TECHNOLOGIES, INC.	, San Jose, California , E. U. DE NORTEAMERICA	
452607	09/04/2024	AZUL PREMIUM QUALITY	34	SOUZA CRUZ LTDA	Av. Republica do Chile, 330, Bl I, Salas 3001 a 3301, Centro, 20031170, Rio de Janeiro, RIO DE JANEIRO, BRASIL	194
452608	22/03/2024	VERMELHO PREMIUM QUALITY	34	SOUZA CRUZ LTDA	Av. Republica do Chile, 330, Bl I, Salas 3001 a 3301 , Centro, 20031170, Rio de Janeiro, RJ, BRASIL	194
452609	02/04/2024	PRATA PREMIUM QUALITY	34	SOUZA CRUZ LTDA	Av. Republica do Chile, 330, Bl I, Salas 3001 a 3301 , Centro, 20031170, Rio de Janeiro, RJ, BRASIL	194
453016	21/03/2024	RIELA	41	BAKER BOTTS, LLP	One Shell Plaza, 910 Louisiana, 77002, Houston, Texas , E. U. DE NORTEAMERICA	94
453017	22/03/2024	RIELA	41	BAKER BOTTS, LLP	One Shell Plaza, 910 Louisiana, 77002, Houston, Texas, E. U. DE NORTEAMERICA	94
453067	04/04/2024	GAMO	13	GAMO OUTDOOR, S.L.	Carretera Santa Creu de Calafell, 43, 08830, Sant Boi de Llobregat, Barcelona, ESPAÑA	212
453653	05/04/2024	DMG	5	Mühlbauer Technology GmbH	22547, Hamburgo, ALEMANIA	240
453965	04/04/2024	BMW	7 y 12	BAYERISCHE MOTOREN WERKE AKTIENGESELLSCHAFT	Petuelring 130, 80809, Munich, ALEMANIA	194
455017	01/04/2024	VIGILIA COMPAÑÍA Y ENFERMERÍA	44	NUEVA COMPAÑÍA - SISTEMA ASISTENCIAL LTDA.	Cuareim 1500, Montevideo, URUGUAY	194
455748	05/04/2024	WD ELEMENTS	9	WESTERN DIGITAL	5601 Great Oaks Parkway,	212

N° Exp.	Resolución	Denominación	Clases	Titular	Dirección	Ag.
				TECHNOLOGIES, INC.	95119, San Jose, California, URUGUAY	
455898	04/04/2024	WD MY CLOUD	9 y 42	WESTERN DIGITAL TECHNOLOGIES, INC.	5601 Great Oaks Parkway, 95119, San Jose, California, URUGUAY	212
455907	22/03/2024	PACIFIC	29	SOLDO HNOS. S.A.	Bv. José Batlle y Ordóñez 6781, MONTEVIDEO, URUGUAY	18
456982	09/04/2024	ORIGINAL ÚLTIMO	30	WM. WRIGLEY JR. COMPANY	1132 West Blackhawk Street, 60642, Chicago, Illinois, E. U. DE NORTEAMERICA	245
456983	09/04/2024	AWESOME ORIGINAL	30	WM. WRIGLEY JR. COMPANY	1132 West Blackhawk Street, 60642, Chicago, Illinois, E. U. DE NORTEAMERICA	245
456984	09/04/2024	GUSHING GRAPE	30	WM. WRIGLEY JR. COMPANY	1132 West Blackhawk Street, 60642, Chicago, Illinois, E. U. DE NORTEAMERICA	245
456985	03/04/2024	AIRWAVES	30	WM. WRIGLEY JR. COMPANY	1132 West Blackhawk Street, 60642, Chicago, Illinois, E. U. DE NORTEAMERICA	245
457290	21/03/2024	MATUTINA NUEVA FUENTE MAS LIVIANA AGUA MINERAL PURA DE MANANTIAL CON GAS	32	FORT-MASIS S.A.	Ruta 101 KM 24.500, CANELONES, URUGUAY	18
457291	21/03/2024	MATUTINA NUEVA FUENTE MAS LIVIANA AGUA MINERAL PURA DE MANANTIAL SIN GAS	32	FORT-MASIS S.A.	Ruta 101 KM 24.500, CANELONES, URUGUAY	245
457674	04/04/2024	WD BLUE	9	WESTERN DIGITAL TECHNOLOGIES, INC.	5601 Great Oaks Parkway, 95119, San Jose, California, URUGUAY	212
463250	04/04/2024		10	NIPRO CORPORATION	3-26, Senriokashinmachi, Settsu, 566-8510, Osaka, JAPON	156
463390	05/04/2024	MY BOOK	9	WESTERN DIGITAL TECHNOLOGIES, INC.	5601 Great Oaks Parkway, 95119, San Jose, California , E.	212

N° Exp.	Resolución	Denominación	Clases	Titular	Dirección	Ag.
					U. DE NORTEAMERICA	
474251	08/04/2024	ISMO	5	Esteve Pharmaceuticals GmbH	Hohenzollerndamm 150 – 151, 14199 , Berlin, ALEMANIA	201
475377	05/04/2024	WD RED	9	WESTERN DIGITAL TECHNOLOGIES, INC.	5601 Great Oaks Parkway, 95119, San Jose, California, URUGUAY	212
475378	05/04/2024	WD BLACK	9	WESTERN DIGITAL TECHNOLOGIES, INC.	5601 Great Oaks Parkway, 95119, San Jose, California, URUGUAY	212
477517	05/04/2024	WD GOLD	9 y 42	WESTERN DIGITAL TECHNOLOGIES, INC.	5601 Great Oaks Parkway, 95119, San Jose, California, E. U. DE NORTEAMERICA	212
493542	21/03/2024	STELA - SIMPLE TEST LANGUAGE	9 y 42	BILESTAR S.A.	Gral. José María Paz 1481, Montevideo, URUGUAY	212
494417	01/04/2024	INTRAROSA	5	Endoceutics, Inc.	100-1195, Louis-Adolphe-Robitaille Street, G1S 0B8, Québec , (Québec) , CANADA	221
495742	21/03/2024	CASA CIPRIANI	36, 41, 43 y 44	ALTUNIS - TRADING, GESTÃO E SERVIÇOS, SOCIEDADE UNIPESSOAL, LDA.	Avenida Arriaga, número 73, 1 andar, sala 113, 9000-0600, Funchal, Madeira, PORTUGAL	212
496310	04/04/2024	SUREFUSER	10	NIPRO CORPORATION	3-26, Senriokashinmachi, Settsu, 566-8510, Osaka, JAPON	156
496748	03/04/2024	IMPETU PUBLICIDAD	35 y 38	DENA S.A.	Ciudad de Paris 5969, Montevideo, Montevideo, URUGUAY	94
501112	21/03/2024	CIPRIANI	29, 30, 32, 33 y 43	ALTUNIS - TRADING, GESTÃO E SERVIÇOS, SOCIEDADE UNIPESSOAL, LDA.	Avenida Arriaga, número 73, 1 andar, sala 113, 09000-0600, FUNCHAL, MADEIRA, PORTUGAL	212
502004	02/04/2024	IMPETU	9 y 16	DENA S.A.	Ciudad de París 5969, Montevideo, URUGUAY	94
503283	04/04/2024		5 y 21	NIPRO CORPORATION	3-26, Senriokashinmachi, Settsu, 566-8510, Osaka, JAPON	156

N° Exp.	Resolución	Denominación	Clases	Titular	Dirección	Ag.
503286	04/04/2024	NIPRO	5 y 21	NIPRO CORPORATION	3-26, Senriokashinmachi, Settsu, 566-8510, Osaka, JAPON	156
508182	08/04/2024	FENERGAN	5	Sanofi Mature IP	82 Avenue Raspail, 94250, Gentilly, FRANCIA	144
509304	21/03/2024	PUNTA MUSIC	41	ALTUNIS - TRADING, GESTÃO E SERVIÇOS, SOCIEDADE UNIPESSOAL, LDA.	Avenida Arriaga, número 73, 1 andar, sala 113, 9000-0600, FUNCHAL, MADEIRA, PORTUGAL	212
510516	04/04/2024	SAFELET	10	NIPRO CORPORATION	3-26, Senriokashinmachi, Settsu, 566-8510, Osaka, JAPON	156
516740	04/04/2024	IMEP	41 y 42	NIPRO CORPORATION	3-26, Senriokashinmachi, Settsu, 566-8510, Osaka, JAPON	156
521161	02/04/2024	IMPETU GROUP	35, 38 y 41	DENA S.A.	Ciudad de París 5969, Montevideo, URUGUAY	94
521227	04/04/2024	NIPRO	10	NIPRO CORPORATION	3-26, Senriokashinmachi, Settsu, 566-8510, Osaka, JAPON	156
521477	03/04/2024	LA OCTAVA MARAVILLA	35, 39, 41 y 43	DENA S.A.	Ciudad de París 5969, Montevideo, URUGUAY	94
522585	04/04/2024	TP-SURE	10	NIPRO CORPORATION	3-26, Senriokashinmachi, Settsu, 566-8510, Osaka, JAPON	156
528075	04/04/2024	HEMOQUIC	5	NIPRO CORPORATION	3-26, Senriokashinmachi, Settsu, 566-8510, Osaka, JAPON	156
528259	04/04/2024	DOSESAVER	10	NIPRO CORPORATION	3-26, Senriokashinmachi, Settsu, 566-8510, Osaka, JAPON	156
533413	04/04/2024	SUREFLUX	10	NIPRO CORPORATION	3-26, Senriokashinmachi, Settsu, 566-8510, Osaka, JAPON	156
545110	05/04/2024	NIPRO	10	NIPRO CORPORATION	3-26, Senriokashinmachi, Settsu, 566-8510, Osaka, JAPON	156
549841	05/04/2024	ESTROCLIM	5	URUFARMA S.A.	Paraguay 1246, Montevideo, URUGUAY	34
553434	04/04/2024	SAFETOUCH	10	NIPRO CORPORATION	3-26, Senriokashinmachi, Settsu, 566-8510, Osaka, JAPON	156
556411	22/03/2024	S	3, 5, 9, 10, 11, 35, 41, 42 y 44	Solventum Intellectual Properties Company	3M Center, 275-6E-21 2510 Conway Ave E Maplewood, MN	212

N° Exp.	Resolución	Denominación	Clases	Titular	Dirección	Ag.
					55144, E. U. DE NORTEAMERICA	
559343	02/04/2024	DITA	25	DITA, INC.	1 Columbia, Aliso Viejo, 92656, CA, E. U. DE NORTEAMERICA	34

Cambios de domicilio de frases publicitarias, inscriptos

N° Exp.	Resolución	Denominación	Clases	Titular	Dirección	Ag.
558501	02/04/2024	MUCHO MÁS QUE UN PAÍS	9, 35, 36, 38, 39, 41, 42 y 43	DENA S.A.	Ciudad de París 5969, Montevideo, URUGUAY	94

Cambios de domicilio de patentes, inscriptos

N° Exp.	Resolución	Denominación	Clases	Titular	Dirección	Ag.
039191	09/04/2024			TENEOBIO, Inc.		205

EMBARGOS Y OTRAS PROHIBICIONES INSCRIPTOS***Prendas de marcas, inscriptas***

N° Exp.	Resolución	Denominación	Clases	Titular	Dirección	Ag.
437939	03/04/2024	PRODUCT OF ITALY,CIPRIANI R FOOD VENEZIA 1931, TAGLIOLINI - EXTRA THIN EGG PASTA, EXPERIENCE OUR RESTAURANTS AT HOME, CIPRIANIS RECIPE INSIDE, PRODUCT OF ITALY,CIPRIANI R FOOD VENEZIA 1931, TAGLIOLINI - EXTRA THIN EGG PASTA, PRODUCT OF ITALY,CIPRIANI R FOOD VENEZIA 1931, TAGLIOLINI- EXTRA THIN EGG PASTA, EXPERIENCE OUR RESTAURANTS AT HOME, CIPRIANIS RECIPE INSIDE, PRODUCT OF ITALY,CIPRIANI R FOOD VENEZIA 1931, TAGLIOLINI - EXTRA THIN EGG PASTA, CIPRIANI R FOOD VENEZIA 1931, TAGLIOLINI -EXTRA THIN EGG PASTA, PRODUCT OF	30	ALTUNIS - TRADING, GESTÃO E SERVIÇOS, SOCIEDADE UNIPESSOAL, LDA	Avenida Arriaga, número 73, 1 andar, sala 113, 9000-0600, Funchal, Madeira, PORTUGAL	212

N° Exp.	Resolución	Denominación	Clases	Titular	Dirección	Ag.
		ITALY EXPERIENCE OUR RESTAURANTS AT HOME, CIPRIANIS RECIPE INSIDE, PRODUCT OF ITALY,CIPRIANI R FOOD VENEZIA 1931, TAGLIOLINI - EXTRA THIN EGG PASTA, CIPRIANI R FOOD VENEZIA 1931, TAGLIOLINI - EXTRA THIN EGG PASTA, PRODUCT OF ITALY CIPRIANI R FOOD VENEZIA 1931				
437940	03/04/2024	PRODUCT OF ITALY, CIPRIANI R FOOD VENEZIA 1931, TAGLIARDI EXTRA THIN EGG PASTA, EXPERIENCE OUR RESTAURANTS AT HOME, CIPRIANI'S RECIPE INSIDE, PRODUCT OF ITALY, CIPRIANI R FOOD VENEZIA 1931, TAGLIARDI EXTRA THIN EGG PASTA, PRODUCT OF ITALY, CIPRIANI R FOOD VENEZIA 1931, TAGLIARDI EXTRA THIN EGG PASTA, EXPERIENCE OUR RESTAURANTS AT HOME, CIPRIANI'S RECIPE INSIDE, PRODUCT	30	ALTUNIS - TRADING, GESTÃO E SERVIÇOS, SOCIEDADE UNIPESSOAL, LDA	Avenida Arriaga, número 73, 1 andar, sala 113, 9000-0600, Funchal, Madeira, PORTUGAL	212

N° Exp.	Resolución	Denominación	Clases	Titular	Dirección	Ag.
		OF ITALY, CIPRIANI R FOOD VENEZIA 1931, TAGLIARDI EXTRA THIN EGG PASTA, CIPRIANI R FOOD VENEZIA 1931, TAGLIARDI EXTRA THIN EGG PASTA, PRODUCT OF ITALY EXPERIENCE OUR RESTAURANTS AT HOME, CIPRIANI'S RECIPE INSIDE, PRODUCT OF ITALY, CIPRIANI R FOOD VENEZIA 1931, TAGLIARDI EXTRA THIN EGG PASTA, CIPRIANI R FOOD VENEZIA 1931, TAGLIARDI EXTRA THIN EGG PASTA, PRODUCT OF ITALY CIPRIANI R FOOD VENEZIA 1931				
437941	04/04/2024	PRODUCT OF ITALY,CIPRIANI R FOOD VENEZIA 1931, PAPPARDELLE - EXTRA THIN EGG PASTA. EXPERIENCE OUR RESTAURANTS AT HOME, CIPRIANIS RECIPE INSIDE, PRODUCT OF ITALY,CIPRIANI R FOOD VENEZIA 1931, PAPPARDELLE- EXTRA THIN EGG PASTA, PRODUCT OF	30	ALTUNIS TRADING GESTÃO E SERVIÇOS LDA	9000-050, Funchal, Madeira, PORTUGAL	212

N° Exp.	Resolución	Denominación	Clases	Titular	Dirección	Ag.
		ITALY,CIPRIANI R FOOD VENEZIA 1931, PAPPARDELLE - EXTRA THIN EGG PASTA. EXPERIENCE OUR RESTAURANTS AT HOME, CIPRIANIS RECIPE INSIDE, PRODUCT OF ITALY,CIPRIANI R FOOD VENEZIA 1931, PAPPARDELLE - EXTRA THIN EGG PASTA, CIPRIANI R FOOD VENEZIA 1931, PAPPARDELLE -EXTRA THIN EGG PASTA, PRODUCT OF ITALY. EXPERIENCE OUR RESTAURANTS AT HOME, CIPRIANIS RECIPE INSIDE, PRODUCT OF ITALY,CIPRIANI R FOOD VENEZIA 1931, PAPPARDELLE - EXTRA THIN EGG PASTA, CIPRIANI R FOOD VENEZIA 1931, PAPPARDELLE - EXTRA THIN EGG PASTA, PRODUCT OF ITALY. CIPRIANI R FOOD VENEZIA 1931				
437942	05/04/2024	DELICATE ZERO CHOLESTEROL, CIPRIANI	30	ALTUNIS - TRADING, GESTÃO E SERVIÇOS,	Avenida Arriaga, número 73, 1 andar, sala 113, 9000-0600,	212

N° Exp.	Resolución	Denominación	Clases	Titular	Dirección	Ag.
		<p>R FOOD VENEZIA 1931, TAGLIOLINI- EXTRA THIN DURUM WHEAT AND EGG WHITE, SPECIALTY FOOD. DELICATE CHOLESTEROL ZERO CHOLESTEROL, CIPRIANI R FOOD VENEZIA 1931, TAGLIOLINI DI GRANO DURO E ALBUME D' UOVO EXTRA SOTTILI SPECIALITÁ ALIMENTARE, DELICATE ZERO CHOLESTEROL, CIPRIANI R FOOD VENEZIA 1931, TAGLIOLINI- EXTRA THIN DURUM WHEAT AND EGG WHITE, SPECIALTY FOOD. DELICATE CHOLESTEROL ZERO CHOLESTEROL, CIPRIANI R FOOD VENEZIA 1931, TAGLIOLINI DI GRANO DURO E ALBUME D' UOVO EXTRA SOTTILI SPECIALITÁ ALIMENTARE,CIPRIANI R FOOD VENEZIA 1931, TAGLIOLINI- EXTRA THIN DURUM WHEAT AND EGG WHITE, SPECIALTY FOOD. DELICATE CHOLESTEROL ZERO CHOLESTEROL,</p>		<p>SOCIEDADE UNIPessoal, LDA</p>	<p>Funchal, Madeira, PORTUGAL</p>	

N° Exp.	Resolución	Denominación	Clases	Titular	Dirección	Ag.
		CIPRIANI R FOOD VENEZIA 1931, TAGLIOLINI DI GRANO DURO E ALBUME D' UOVO EXTRA SOTTILI SPECIALITÀ ALIMENTARE,CIPRIANI R FOOD VENEZIA 1931, TAGLIOLINI- EXTRA THIN DURUM WHEAT AND EGG WHITE, SPECIALTY FOOD. CIPRIANI R FOOD VENEZIA 1931				
437943	03/04/2024	PRODUCT OF ITALY,CIPRIANI R FOOD VENEZIA 1931, TAGLIARELLE EXTRA THIN EGG PASTA, EXPERIENCE OUR RESTAURANTS AT HOME, CIPRIANIS RECIPE INSIDE, PRODUCT OF ITALY,CIPRIANI R FOOD VENEZIA 1931, TAGLIARELLE EXTRA THIN EGG PASTA, PRODUCT OF ITALY,CIPRIANI R FOOD VENEZIA 1931, TAGLIARELLE EXTRA THIN EGG PASTA, EXPERIENCE OUR RESTAURANTS AT HOME, CIPRIANIS RECIPE	30	ALTUNIS - TRADING, GESTÃO E SERVIÇOS, SOCIEDADE UNIPESSOAL, LDA.	Avenida Arriaga, número 73, 1 andar, sala 113, 9000-0600, Funchal, Madeira, PORTUGAL	212

N° Exp.	Resolución	Denominación	Clases	Titular	Dirección	Ag.
		INSIDE, PRODUCT OF ITALY,CIPRIANI R FOOD VENEZIA 1931, TAGLIARELLE EXTRA THIN EGG PASTA, CIPRIANI R FOOD VENEZIA 1931, TAGLIARELLE EXTRA THIN EGG PASTA, PRODUCT OF ITALY EXPERIENCE OUR RESTAURANTS AT HOME, CIPRIANIS RECIPE INSIDE, PRODUCT OF ITALY,CIPRIANI R FOOD VENEZIA 1931, TAGLIARELLE EXTRA THIN EGG PASTA, CIPRIANI R FOOD VENEZIA 1931, TAGLIARELLE EXTRA THIN EGG PASTA, PRODUCT OF ITALY CIPRIANI R FOOD VENEZIA 1931				
437944	03/04/2024	CIPRIANI R FOOD VENEZIA 1931, TAGLIOLINI - EXTRA THIN EGG PASTA, CIPRIANI R FOOD VENEZIA 1931, TAGLIOLINI- ALL'UOVO EXTRA SOTTILI, CIPRIANI R FOOD VENEZIA 1931,	30	ALTUNIS - TRADING, GESTÃO E SERVIÇOS, SOCIEDADE UNIPESSOAL, LDA.	Avenida Arriaga, número 73, 1 andar, sala 113, 9000-0600, Funchal, Madeira, PORTUGAL	212

N° Exp.	Resolución	Denominación	Clases	Titular	Dirección	Ag.
		TAGLIOLONI- EXTRA THIN EGG PASTA, CIPRIANI R FOOD VENEZIA 1931, TAGLIOLINI- ALL'UOVO EXTRA SOTTILI, CIPRIANI R FOOD VENEZIA 1931, TAGLIOLONI- EXTRA THIN EGG PASTA, CIPRIANI R FOOD VENEZIA 1931, TAGLIOLINI- ALL'UOVO EXTRA SOTTILI, CIPRIANI R FOOD VENEZIA 1931, TAGLIOLONI- EXTRA THIN EGG PASTA, CIPRIANI R FOOD VENEZIA 1931				
438419	03/04/2024	CIPRIANI R FOOD VENEZIA 1931 PAPPARDELLE - EXTRA THIN WITH EGG AND KHORASAN WHEAT SPECIALTY FOOD CIPRIANI R FOOD VENEZIA 1931 PAPPARDELLE ALL'UOVO E GRANO KHORASAN EXTRA SOTTILI SPECIALITÀ ALIMENTARE CIPRIANI R FOOD VENEZIA 1931 PAPPARDELLE ALL'UOVO E GRANO KHORASAN	30	ALTUNIS - TRADING, GESTÃO E SERVIÇOS, SOCIEDADE UNIPESSOAL, LDA	Avenida Arriaga, número 73, 1 andar, sala 113, 9000-0600, Funchal, Madeira, PORTUGAL	212

N° Exp.	Resolución	Denominación	Clases	Titular	Dirección	Ag.
		EXTRA SOTTILI SPECIALITÀ ALIMENTARE CIPRIANI FOOD				
438420	08/04/2024	CIPRIANI R FOOD VENEZIA 1931 TAGLIOLINI - EXTRA THIN EGG PASTA WITH TOMATO CIPRIANI R FOOD VENEZIA 1931 TAGLIOLINI ALL'UOVO EXTRA SOTTILI CON POMODORO CIPRIANI R FOOD VENEZIA 1931 TAGLIOLINI ALL'UOVO EXTRA SOTTILI WITH TOMATO TAGLIOLINI EXTRA THIN EGG PASTA WITH TOMATO CIPRIANI FOOD	30	ALTUNIS TRADING GESTÃO E SERVIÇOS LDA	Avenida Arriaga, número 73, 1 andar, sala 113, 9000-0600, Funchal, Madeira, PORTUGAL	212
438421	04/04/2024	CIPRIANI R FOOD VENEZIA 1931 TAGLIOLINI - EXTRA THIN EGG PASTA WITH SPINACH CIPRIANI R FOOD VENEZIA 1931 TAGLIOLINI ALL'UOVO EXTRA SOTTILI CON SPINACI CIPRIANI R FOOD VENEZIA 1931 TAGLIOLINI EXTRA THIN EGG PASTA WITH SPINACH TAGLIOLINI ALL'UOVO EXTRA	30	ALTUNIS - TRADING, GESTÃO E SERVIÇOS, SOCIEDADE UNIPESSOAL, LDA.	Avenida Arriaga, número 73, 1 andar, sala 113, 9000-0600, Funchal, Madeira, PORTUGAL	212

N° Exp.	Resolución	Denominación	Clases	Titular	Dirección	Ag.
		SOTTILI CON SPINACI CIPRIANI FOOD				
466978	03/04/2024	CIPRIANI KNABLE INTERNATIONAL	43	ALTUNIS - TRADING, GESTÃO E SERVIÇOS, SOCIEDADE UNIPESSOAL, LDA.	Avenida Arriaga, número 73, 1 andar, sala 113, 9000-0600, Funchal, Madeira, PORTUGAL	212
466979	03/04/2024	CIPRIANI PUNTA DEL ESTE RESORT SPA CASINO	43	ALTUNIS - TRADING, GESTÃO E SERVIÇOS, SOCIEDADE UNIPESSOAL, LDA.	Avenida Arriaga, número 73, 1 andar, sala 113, 9000-0600, Funchal, Madeira, PORTUGAL	212
466980	04/04/2024	CIPRIANI COLLECTION	43	ALTUNIS - TRADING, GESTÃO E SERVIÇOS, SOCIEDADE UNIPESSOAL, LDA.	Avenida Arriaga, número 73, 1 andar, sala 113, 9000-0600, Funchal, Madeira, PORTUGAL	212
473349	04/04/2024	THE ORIGINAL HARRY'S BAR COCKTAIL BELLINI CIPRIANI THE FAMOUS HARRY'S BAR - VENEZIA 1931	32 y 33	ALTUNIS - TRADING, GESTÃO E SERVIÇOS, SOCIEDADE UNIPESSOAL, LDA.	Avenida Arriaga, número 73, 1 andar, sala 113, 9000-0600, Funchal, Madeira, PORTUGAL	212
476125	04/04/2024	CIPRIANI RESIDENCES	35, 36, 37, 43 y 45	ALTUNIS - TRADING, GESTÃO E SERVIÇOS, SOCIEDADE UNIPESSOAL, LDA.	AVENIDA ARRIAGA, NUMERO 73, 1 ANDAR, SALA 113, 9000-060, Funchal, Madeira, PORTUGAL	212
491686	04/04/2024	CIPRIANI	29, 30 y 33	ALTUNIS - TRADING, GESTÃO E SERVIÇOS, SOCIEDADE UNIPESSOAL, LDA.	Avenida Arriaga, número 73, 1 andar, sala 113, 09000-0600, Funchal, Madeira, PORTUGAL	212
491688	04/04/2024	CIPRIANI	36, 37, 41, 43, 44 y 45	ALTUNIS - TRADING, GESTÃO E SERVIÇOS, SOCIEDADE UNIPESSOAL, LDA.	Avenida Arriaga, número 73, 1 andar, sala 113, 9000-0600, Funchal, Madeira, PORTUGAL	212
493985	05/04/2024	BELLINI	32 y 33	ALTUNIS - TRADING, GESTÃO E SERVIÇOS, SOCIEDADE	Avenida Arriaga, número 73, 1 andar, sala 113, 9000-0600, Funchal, Madeira, PORTUGAL	212

N° Exp.	Resolución	Denominación	Clases	Titular	Dirección	Ag.
				UNIPESOAL, LDA.		
495742	05/04/2024	CASA CIPRIANI	36, 41, 43 y 44	ALTUNIS - TRADING, GESTÃO E SERVIÇOS, SOCIEDADE UNIPESOAL, LDA.	Avenida Arriaga, número 73, 1 andar, sala 113, 9000-0600, Funchal, Madeira, PORTUGAL	212
496384	05/04/2024	CIPRIANI	35	ALTUNIS - TRADING, GESTÃO E SERVIÇOS, SOCIEDADE UNIPESOAL, LDA.	Rua Das Pretas N° 43, 2° Andar, Sala 7, 9000-050, Funchal, Madeira, PORTUGAL	212
501111	05/04/2024	BELLINI CIPRIANI	32 y 33	ALTUNIS - TRADING, GESTÃO E SERVIÇOS, SOCIEDADE UNIPESOAL, LDA.	Avenida Arriaga, número 73, 1 andar, sala 113, 9000-0600, FUNCHAL, MADEIRA, PORTUGAL	212
501112	05/04/2024	CIPRIANI	29, 30, 32, 33 y 43	ALTUNIS - TRADING, GESTÃO E SERVIÇOS, SOCIEDADE UNIPESOAL, LDA.	Avenida Arriaga, número 73, 1 andar, sala 113, 09000-0600, FUNCHAL, MADEIRA, PORTUGAL	212
509304	05/04/2024	PUNTA MUSIC	41	ALTUNIS - TRADING, GESTÃO E SERVIÇOS, SOCIEDADE UNIPESOAL, LDA.	Avenida Arriaga, número 73, 1 andar, sala 113, 9000-0600, FUNCHAL, MADEIRA, PORTUGAL	212
515422	05/04/2024	CIPRIANI OCEAN RESORT AND CLUB RESIDENCES	35, 36, 37, 41, 43, 44 y 45	ALTUNIS - TRADING, GESTÃO E SERVIÇOS, SOCIEDADE UNIPESOAL, LDA.	Avenida Arriaga, número 73, 1 andar, sala 113, Funchal, 9000- 060, Madeira, Madeira, PORTUGAL	212
524718	05/04/2024	HARRY'S BAR	41	ALTUNIS - TRADING, GESTÃO E SERVIÇOS SOCIEDADE UNIPESOAL, LDA.	Avenida Arriaga, Numero 73, 1 Andar, Sala 113, 9000-060, FUNCHAL, MADEIRA, PORTUGAL	212
524723	05/04/2024	HARRY'S BAR	43	ALTUNIS - TRADING, GESTÃO E SERVIÇOS SOCIEDADE UNIPESOAL, LDA.	Avenida Arriaga, Numero 73, 1 Andar, Sala 113, 9000-060, FUNCHAL, MADEIRA, PORTUGAL	212
526810	05/04/2024	CIPRIANI	43 y 44	ALTUNIS - TRADING,	Avenida Arriaga, Numero 73, 1	212

N° Exp.	Resolución	Denominación	Clases	Titular	Dirección	Ag.
				GESTAO E SERVICOS SOCIEDADE UNIPESSOAL, LDA.	Andar, Sala 113,, FUNCHAL, 9000-060, MADEIRA, MADEIRA, PORTUGAL	
526811	08/04/2024	CIPRIANI	32	ALTUNIS - TRADING, GESTAO E SERVICOS SOCIEDADE UNIPESSOAL, LDA.	Avenida Arriaga, Numero 73, 1 Andar, Sala 113,, FUNCHAL, 9000-060, MADEIRA, MADEIRA, PORTUGAL	212
538677	08/04/2024	SOCIALISTA	43	ALTUNIS-TRADING, GESTÃO E SERVIÇOS, SOCIEDADE UNIPESSOAL, LDA	Avenida Arriaga N° 73, 1° andar, sala 113, Funchal Madeira, PORTUGAL, PORTUGAL, PORTUGAL	212
546344	08/04/2024	PICKERING	43	ALTUNIS-TRADING, GESTÃO E SERVIÇOS, SOCIEDADE UNIPESSOAL, LDA	Avenida Arriaga N° 73, 1° andar, sala 113, Funchal, 9000-080, Funchal, Madeira, PORTUGAL	212
547629	08/04/2024	CIPRIANI	1, 2, 4, 5, 6, 7, 10, 11, 12, 13, 15, 17, 19, 28 y 34	ALTUNIS-TRADING, GESTÃO E SERVIÇOS, SOCIEDADE UNIPESSOAL, LDA	Avenida Arriaga N° 73, 1° andar, sala 113, Funchal, 9000-080, Funchal, Madeira, PORTUGAL	212

RENUNCIAS INSCRIPTAS***Renuncias totales de marcas, inscriptas***

N° Exp.	Resolución	Denominación	Clases	Titular	Dirección	Ag.
434083	04/04/2024	GINO	9 y 42	EDEREY S.A.	Ituzaingó 1324 esc. 601, Montevideo, Montevideo, URUGUAY	220
439216	04/04/2024	PROSINA ROEMMERS	5	Mega Labs S.A.	Ruta 101 Km. 23.500, Parque de las Ciencias, Edificio Mega Pharma, Piso 3, Canelones, Colonia Nicolich, Colonia Nicolich, URUGUAY	144
490629	04/04/2024	RAPPI PRIME	39, 42 y 43	Rappi S.A.S.	Calle 93 # 19-58, Bogotá, Bogotá, COLOMBIA	218
534318	08/04/2024	ERB CBD PHARMA GRADE	3 y 5	MONTJUIC S.A.	APARICIO SARAVIA S/N, LABORATORIOS 2 Y 4, -, MONTEVIDEO, MONTEVIDEO, URUGUAY	201

Renuncias parciales de marcas, inscriptas

N° Exp.	Resolución	Denominación	Clases	Titular	Dirección	Ag.
494218	01/04/2024	SM	3, 16, 29 y 30	POLAKOF Y CIA. S.A.	Avenida Artigas 779, Maldonado, Maldonado, URUGUAY	94
509160	01/04/2024	ANIMATE! RECREACIÓN & EVENTOS	41	ZACHEO, CARLOS y CASULO, GONZALO	ATILIO NARANCIO 3134, MONTEVIDEO, MONTEVIDEO, MONTEVIDEO, URUGUAY y SOLANO GARCIA 2567 APTO 3, MONTEVIDEO, MONTEVIDEO, MONTEVIDEO, URUGUAY	201
547409	01/04/2024	CENCORA	35, 36, 39 y 42	Cencora, Inc.	1 West First Avenue,	194

N° Exp.	Resolución	Denominación	Clases	Titular	Dirección	Ag.
					Conshohocken, Pennsylvania 19428, Conshohocken, Pennsylvania 19428, -, E. U. DE NORTEAMERICA	
553409	01/04/2024	QUÉ PLANAZO!	35, 38 y 41	Arde SAS	Ituzaingo 1409,, Montevideo, Montevideo, Montevideo, URUGUAY	212
553769	01/04/2024	FREESTYLER	5, 18, 25, 28, 30, 32, 35 y 41	SOLSIRE S.A.	General Flores 4441, Montevideo, Montevideo, Montevideo, URUGUAY	94

DESISTIMIENTOS***Notarial desistimientos***

N° Exp.	Resolución	Denominación	Clases	Titular	Dirección	Ag.
551878	02/04/2024	ALTO DE LA BALLENA	33	DORILAR SA	Ruta 12 km 16.4, San Carlos, 20000, San Carlos, Maldonado, URUGUAY	

RESOLUCIONES DE RECURSOS Y REIVINDICACIONES***Resoluciones de marcas, revocadas por DNPI***

N° Exp	Resolución	Expediente y titular	Clases	Notas	Ag.
540432	02/04/2024	NEO DOLCE GUSTO NESCAFÉ (mixta) / Soci��t�� des Produits Nestl�� S.A.	30 (Concedida S/D), 29 (Concedida S/D) y 11 (Concedida S/D)		212
547090	22/03/2024	AT��PICO COMEDOR (mixta) / URIARTE PUPPO INES Y PUPPO VALLINI BLANCA CORINA SOCIEDAD DE HECHO	43 (Concedida S/D)		186

CONCESIONES DE PATENTES***Patentes concedidas***

N° Exp	Resolución	Título	Titular	Ag.
No. 36521	08/04/2024	Forma cristalina de 4-[(4S)-5,7-difluoro-3,4-dihidro-2H-cromen-4-il]oxi]-N,N,2-trimetil-1H-bencimidazol-6-carboxamida y su método de preparación.	HK INNO.N CORPORATION	34
No. 36671	08/04/2024	COMPOSICIONES DE ARNi CONTRA FACTOR XII (FACTOR DE HAGEMAN)(F12) Y MÉTODOS DE USO DE LOS MISMOS	Alnylam Pharmaceuticals, Inc.	218
No. 36802	08/04/2024	VACUNA CONTRA LA GARRAPATA DEL GANADO BOVINO	INSTITUTO NACIONAL DE INVESTIGACION AGROPECUARIA; UNIVERSIDADE FEDERAL DO RIO GRANDE DO SUL; UNIVERSIDAD FEDERAL DE CIÊNCIAS DA SAUDE DE PORTO ALEGRE y UNIVERSIDAD DE LA REPUBLICA	
No. 37146	08/04/2024	LIGANDOS DE DIRECCIONAMIENTO PARA COMPUESTOS TERAPÉUTICOS	Arrowhead Pharmaceuticals, Inc.	216
No. 37265	08/04/2024	DERIVADOS FUNGICIDAS DE TIAZOL CARBOXAMIDA	SYNGENTA PARTICIPATIONS AG	194
No. 40378	08/04/2024	Sistema de conexión y de recipiente	BOEHRINGER INGELHEIM VETMEDICA GMBH	192

Diseños industriales concedidos

N° Exp	Resolución	Título	Titular	Ag.
No. 5051	08/04/2024	CONECTOR	SONY INTERACTIVE ENTERTAINMENT INC.	201
No. 5052	08/04/2024	CARCASA DE CONTROLADOR PARA DISPOSITIVO ELECTRÓNICO	SONY INTERACTIVE ENTERTAINMENT INC.	201

DESESTIMACIONES Y ABANDONOS DE PATENTES**Patentes desestimadas**

N° Exp	Resolución	Título	Titular	Ag.
No. 35347	08/04/2024	ÁCIDO [(4-HIDROXI-1-METIL-7-FENOXI-ISOQUINOLINA-3-CARBONIL)-AMINO]-ACÉTICO CRISTALINO (COMPUESTO A FORMA A) COMO INHIBIDOR DE LA PROLIL HIDROXILASA Y COMPOSICIONES FARMACEÚTICAS QUE LO COMPRENDEN.	FibroGen, Inc.	34
No. 37361	08/04/2024	SULFONILUREAS Y COMPUESTOS RELACIONADOS Y USO DE ESTOS	The Provost, Fellows, Foundation Scholars, and the other Members of Board, of the College of the Holy and Undivided Trinity of Queen Elizabeth near Dublin. y The University of Queensland	211
No. 37366	08/04/2024	INHIBIDORES DE DIACILGLICEROL ACILTRANSFERASA 2	Pfizer Inc.	211
No. 37442	08/04/2024	DERIVADOS DE FENILAMINA 4-SUSTITUIDOS Y SU USO PARA PROTEGER CULTIVOS AL COMBATIR MICROORGANISMOS FITOPATOGÉNICOS INDESEADOS	PI Industries Ltd	34
No. 37443	08/04/2024	DERIVADOS DE FENILAMINA SUSTITUIDOS EN LA POSICIÓN 4 Y USO DE LOS MISMOS PARA PROTEGER LOS CULTIVOS COMBATIENDO LOS MICROORGANISMOS FITOPATÓGENOS NO DESEADOS	PI Industries Ltd	34
No. 39706	08/04/2024	DERIVADOS DE (1HINDOL- 3-IL)-2-(4-CLORO-2-METOXI-FENIL)-2-((3-METOXI-5-(METILSULFONIL) FENIL)AMINO)ETANONA COMO INHIBIDORES DE LA REPLICACIÓN DEL VIRUS DEL DENGUE	Janssen Pharmaceuticals, Inc. y Katholieke Universiteit Leuven	192
No. 40039	08/04/2024	COMPOSICIONES DE ARNi DEL COMPONENTE DEL	Alnylam Pharmaceuticals, Inc.	218

N° Exp	Resolución	Título	Titular	Ag.
		COMPLEMENTO C5 Y MÉTODOS PARA SU USO		
No. 40128	08/04/2024	UNA COMPOSICION FARMACÉUTICA QUE COMPRENDE UN POLIPÉPTIDO QUE COMPRENDE UN DOMINIO DE FIBRONECTINA TIPO III A LA DÉCIMA (10FN3) QUE SE FIJA A MIOSTATINA	BRISTOL-MYERS SQUIBB COMPANY, Una Corporación del Estado de Delaware	192

Patentes abandonadas

N° Exp	Resolución	Título	Titular	Ag.
No. 37297	08/04/2024	VARIANTES DE PROTOPORFIRINÓGENO OXIDASA Y MÉTODOS Y COMPOSICIONES PARA OTORGAR Y/O MEJORAR LA TOLERANCIA A LOS HERBICIDAS UTILIZANDO LAS MISMAS	FarmHannong Co., Ltd.	216
No. 37762	08/04/2024	SISTEMAS DE MONITOREO INALÁMBRICO DE LARGO ALCANCE	Australian Wool Innovation Limited	216

En virtud de la discrepancia que surge en la actualidad entre la fecha de validez de las resoluciones en los sistemas IPAS y [PAMP](#) con la que surge del Boletín de la DNPI, debe dejarse constancia que la fecha de validez de la resolución correspondiente es la que surge de los sistema IPAS y [PAMP](#), fecha de firma de la misma.

SOLICITUDES DE PATENTES DE INVENCION

(19) Dirección Nacional de la Propiedad Industrial – URUGUAY

(12) Invención

(11) UY a/040088

- (51) **Clasificación Internacional:** G 06Q 10/08(2012.01), G 06Q 30/00(2012.01), G 07F 17/10(2006.01)
- (22) **Fecha de presentación:** 22/12/2022
- (30) **Datos de prioridad:**
- (71) **Solicitante:** TURICUN S.A. [UY]
- (72) **Inventor:** Gabriel Noachas [UY]
- (74) **Agente/apoderado:** Juan Eduardo Vanrell Falcon (144)
- (54) **Título:** PROCEDIMIENTO DE VERIFICACIÓN Y RETIRO DE MERCADERÍA DEPOSITADA EN GABINETES

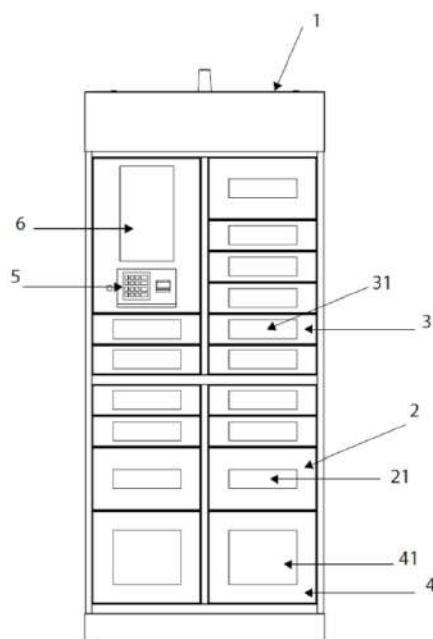

- (57) **Resumen:** Un método para revisar un producto entregado por una Empresa en un gabinete, validar eventualmente dicho producto y retirar el producto validado que emplea un gabinete que posee al menos un vidrio que puede variar su transparencia para permitir la vista del producto en el interior del gabinete. Un armario que comprende dos o más gabinetes que tienen al menos un vidrio que puede variar su transparencia

(19) Dirección Nacional de la Propiedad Industrial – URUGUAY**(12) Invención****(11) UY a/040314**

- (51) Clasificación Internacional:** A 01G 7/06(2006.01), A 01N 25/00(2006.01), A 01N 43/40(2006.01), A 01N 43/54(2006.01), A 01N 43/58(2006.01), A 01N 43/60(2006.01), A 01P 3/00(2006.01), C 07D 213/70(2006.01), C 07D 213/71(2006.01), C 07D 237/18(2006.01), C 07D 239/38(2006.01), C 07D 241/18(2006.01), C 07D 401/12(2006.01) // A 01G 7/06, A 01P 3/00
- (22) Fecha de presentación:** 15/06/2023
- (30) Datos de prioridad:** 2022098034 17/06/2022 JP y 2022180831 11/11/2022 JP
- (71) Solicitante:** SUMITOMO CHEMICAL COMPANY, LIMITED [JP]
- (72) Inventor:** Yoshihiko NOKURA [JP]; Nao MAEHATA [JP]; Keisuke ARAI [JP]
- (74) Agente/apoderado:** GUSTAVO LARROSA DE BRUN (179)
- (54) Título:** MÉTODO PARA CONTROLAR ENFERMEDADES DE LAS PLANTA

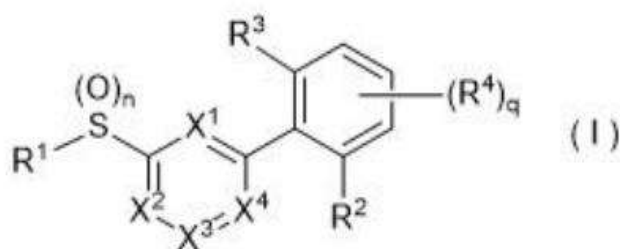

- (57) Resumen:** La presente invención proporciona un método para controlar una enfermedad de las plantas que comprende aplicar un compuesto representado por la fórmula (I).

(19) Dirección Nacional de la Propiedad Industrial – URUGUAY**(12) Invención****(11) UY a/040438**

- (51) Clasificación Internacional:** A 01N 43/50(2006.01), A 01N 43/54(2006.01), A 01N 43/58(2006.01), C 07D 401/04(2006.01), C 07D 403/04(2006.01), C 07D 413/14(2006.01)
- (22) Fecha de presentación:** 21/09/2023
- (30) Datos de prioridad:** 63/409,393 23/09/2022 US
- (71) Solicitante:** FMC CORPORATION [US]
- (72) Inventor:** LAHM, George Philip [US]; NANDI, Jyoti [IN]; PAHUTSKI Jr., Thomas Francis [US]; LONG, Jeffrey Keith [US]
- (74) Agente/apoderado:** AGUSTÍ• N MAYER WEST (205)
- (54) Título:** INSECTICIDAS DE PIRAZOLAMIDA

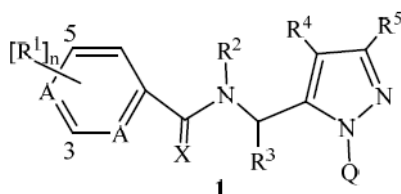

- (57) Resumen:** Se divulgan compuestos de Fórmula 1, y A, R1, R2, R3, R4, R5, Q y X son como se definen en la divulgación. También se divulgan composiciones que contienen los compuestos de Fórmula 1 y métodos para controlar y combatir una plaga de invertebrados que comprenden poner en contacto la plaga de invertebrados o su entorno con una cantidad biológicamente eficaz de un compuesto o una composición de la invención.

(19) Dirección Nacional de la Propiedad Industrial – URUGUAY

(12) Invención

(11) UY a/040440

- (51) **Clasificación Internacional:** C 07D 401/12(2006.01), C 07D 401/14(2006.01), C 07D 413/14(2006.01), C 07D 417/14(2006.01), C 07D 487/04(2006.01), A 61K 31/437(2006.01), A 61K 31/444(2006.01), A 61K 31/506(2006.01), A 61K 31/55(2006.01), A 61K 31/427(2006.01), A 61K 31/4245(2006.01), A 61K 31/422(2006.01), A 61K 31/4184(2006.01), A 61K 31/4025(2006.01), A 61K 31/41(2006.01), A 61P 35/00(2006.01), A 61P 31/00(2006.01), A 61P 29/00(2006.01), A 61P 37/02(2006.01) // A 61P 29/00, 31/00, 35/00, 37/02
- (22) **Fecha de presentación:** 22/09/2023
- (30) **Datos de prioridad:** 2022124945 22/09/2022 RU y 2023122794 01/09/2023 RU
- (71) **Solicitante:** Joint Stock Company "BIOCAD" [RU]
- (72) **Inventor:** Morozov Dmitry Valentinovich [RU]; Voronkova Maria Sergeevna [RU]; MIKHAYLOV LEONID EVGEN'EVICH [RU]; Iakovlev Danila Alekseevich [RU]; Chestnova Anna Yurievna [RU]; Lenshmidt Liliana Vyacheslavovna [RU]; Vikenteva Yulia Arturovna [RU]; Efimenko Nikita Igorevich [RU]; Golubev Artem Alekseevich [RU]; Cheremushkin Andrei Ivanovich [RU]; Lukashenko Anton Vladimirovich [RU]; Smolnikov Sergei Alexandrovich [RU]; Kiselev Maksim Aleksandrovich [RU]; Sharkov Dmitrii Evgenievich [RU]; Shpakova Elena Alexandrovna [RU]; Gorbunova Svetlana [LT]
- (74) **Agente/apoderado:** GONZALO FERNÁNDEZ SECCO (34)
- (54) **Título:** INHIBIDORES DE LA QUINASA 7 DEPENDIENTES DE CICLINA

fórmula I

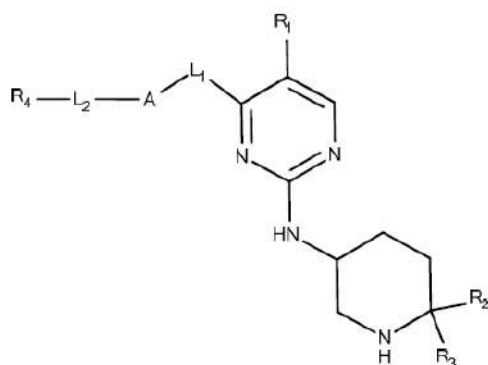

- (57) **Resumen:** La presente invención se refiere a nuevos compuestos de fórmula I o una sal, solvato o estereoisómero farmacéuticamente aceptable del mismo, que tiene propiedades inhibitoras de CDK7, y también a una composición farmacéutica que comprende los presentes compuestos, a métodos para tratar enfermedades o trastornos y al uso de los presentes compuestos como productos farmacéuticos para tratar enfermedades o trastornos.

(19) Dirección Nacional de la Propiedad Industrial – URUGUAY**(12) Invención****(11) UY a/040446**

- (51) Clasificación Internacional:** A 01N 37/34(2006.01), A 01N 37/36(2006.01), A 01N 37/44(2006.01), A 01N 43/56(2006.01), A 01N 43/653(2006.01), A 01P 3/00(2006.01) // A 01P 3/00
- (22) Fecha de presentación:** 27/09/2023
- (30) Datos de prioridad:** 2214203.8 28/09/2022 GB
- (71) Solicitante:** SYNGENTA CROP PROTECTION AG [CH]
- (72) Inventor:** BEATTIE, David [GB]
- (74) Agente/apoderado:** JUAN LAPENNE DE SALTERAIN (211)
- (54) Título:** MEZCLAS FUNGICIDAS DE DERIVADOS DE METOXICACRILATO DE ARILO
- (57) Resumen:** Una composición fungicida que comprende una mezcla de componentes (A), (B) y (C), en donde los componentes (A), (B) y (C) son tal como se definen en la reivindicación 1, y el uso de las composiciones en agricultura u horticultura para controlar o prevenir la infestación de plantas por parte de microorganismos fitopatógenos, preferentemente hongos.

(19) Dirección Nacional de la Propiedad Industrial – URUGUAY**(12) Invención****(11) UY a/040454**

- (51) Clasificación Internacional:** A 01N 37/02(2006.01), A 01N 43/40(2006.01), A 01N 43/50(2006.01), A 01N 57/20(2006.01), C 07D 401/04(2006.01), C 07F 9/30(2006.01)
- (22) Fecha de presentación:** 28/09/2023
- (30) Datos de prioridad:** IN202211055969 29/09/2022 IN
- (71) Solicitante:** UPL Mauritius Limited [MU] y UPL Europe Ltd. [UK]
- (72) Inventor:** Giuvan Lenz [BR]; Ganesh Rao [IN]; Jessica Ferreira Lourenco Leal [BR]
- (74) Agente/apoderado:** GUSTAVO LARROSA DE BRUN (179)
- (54) Título:** UNA COMBINACIÓN HERBICIDA, COMPOSICIÓN Y MÉTODO DE CONTROL DE MALAS HIERBAS USANDO LA MISMA.

- (57) Resumen:** La presente divulgación se refiere a una combinación herbicida que comprende L-glufosinato, sales, ésteres o combinaciones de los mismos, y al menos un herbicida de imidazolinona. Más en particular, la presente divulgación se refiere a un método para controlar malas hierbas con combinaciones herbicidas sinérgicas que comprenden L-glufosinato, sales, ésteres o combinaciones de los mismos, y al menos un herbicida de imidazolinona.

(19) Dirección Nacional de la Propiedad Industrial – URUGUAY**(12) Invención****(11) UY a/040456**

- (51) Clasificación Internacional:** A 01N 41/10(2006.01), A 01N 43/08(2006.01), A 01N 43/10(2006.01), A 01N 43/40(2006.01), A 01N 43/50(2006.01), A 01N 43/56(2006.01), C 07D 233/56(2006.01), C 07D 401/12(2006.01), C 07D 405/12(2006.01), C 07D 417/14(2006.01)
- (22) Fecha de presentación:** 28/09/2023
- (30) Datos de prioridad:** 2022-158301 30/09/2022 JP
- (71) Solicitante:** SUMITOMO CHEMICAL COMPANY, LIMITED [JP]
- (72) Inventor:** Yoshihiko NOKURA [JP]; Nao MAEHATA [JP]; Keisuke ARAI [JP]
- (74) Agente/apoderado:** GUSTAVO LARROSA DE BRUN (179)
- (54) Título:** COMPUESTO DE FENILPIRAZOL Y MÉTODO PARA CONTROLAR ENFERMEDADES VEGETALES

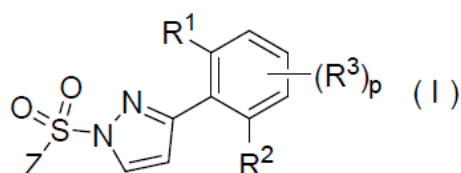

- (57) Resumen:** La presente invención proporciona un excelente método de control contra enfermedades vegetales. Un compuesto representado por la fórmula (I)

(19) Dirección Nacional de la Propiedad Industrial – URUGUAY**(12) Invención****(11) UY a/040458**

- (51) Clasificación Internacional:** C 07K 16/28(2006.01), A 61K 39/395(2006.01), A 61P 27/02(2006.01) // A 61P 27/02
- (22) Fecha de presentación:** 28/09/2023
- (30) Datos de prioridad:** 63/377,870 30/09/2022 US y 63/495,033 07/04/2023 US
- (71) Solicitante:** HORIZON THERAPEUTICS IRELAND DAC [IE]
- (72) Inventor:** Jeffrey Wayne SHERMAN [US]; Elizabeth H.Z. THOMPSON [US]
- (74) Agente/apoderado:** FABIANA PENADES (216)
- (54) Título:** MÉTODOS PARA EL TRATAMIENTO DE LA ENFERMEDAD OCULAR TIROIDEA INACTIVA

- (57) Resumen:** Se describe en el presente documento un método para tratar a un individuo con enfermedad ocular tiroidea (TED) inactiva; el método comprende administrar a un individuo con TED inactiva o crónica un inhibidor del receptor del factor de crecimiento similar a la insulina 1 (IGF1R), tratando así la TED inactiva o crónica.

(19) Dirección Nacional de la Propiedad Industrial – URUGUAY

(12) Invención

(11) UY a/040461

- (51) **Clasificación Internacional:** A 01N 25/00(2006.01), A 01N 43/80(2006.01), C 07D 261/04(2006.01)
- (22) **Fecha de presentación:** 29/09/2023
- (30) **Datos de prioridad:** 63/412,366 30/09/2022 US
- (71) **Solicitante:** FMC CORPORATION [US]
- (72) **Inventor:** Jesper HILDEBRANDT [DK]; Krishnan PALANICHAMY [US]; Paul NICHOLSON [US]; David HENNENS [BE]
- (74) **Agente/apoderado:** STELLA MARINA WENG POLICICCHIO (218)
- (54) **Título:** COMPOSICIONES QUE INCLUYEN BIXLOZONA ENCAPSULADA Y BIXLOZONA NO ENCAPSULADA

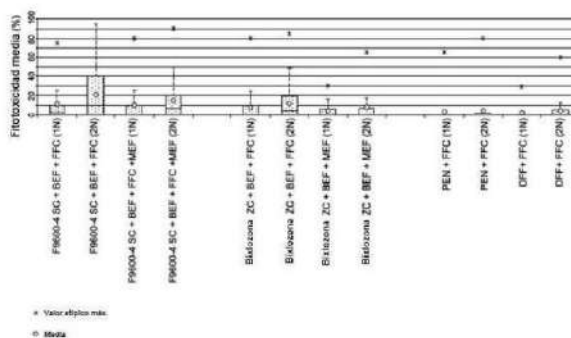

- (57) **Resumen:** En el presente documento se describen composiciones que incluyen bixlozóna encapsulada y bixlozóna no encapsulada. También se describen métodos para preparar las composiciones. También se describen métodos para controlar la vegetación no deseada con las composiciones.

(19) Dirección Nacional de la Propiedad Industrial – URUGUAY**(12) Invención****(11) UY a/040463**

- (51) Clasificación Internacional:** A 01G 22/00(2018.01), A 01G 33/00(2006.01), A 01G 9/00(2018.01), F 17C 3/00(2006.01), B 65H 99/00(2006.01)
- (22) Fecha de presentación:** 29/09/2023
- (30) Datos de prioridad:** 63/411,443 29/09/2022 US
- (71) Solicitante:** CH4 Global, Inc. [US]
- (72) Inventor:** KNEEN, David [AU]; COOK, Sam [AU]; CHRISTIAN, Andrew [AU]; HARDIE, Anne [AU]
- (74) Agente/apoderado:** GONZALO FERNÁNDEZ SECCO (34)
- (54) Título:** SISTEMAS Y MÉTODOS PARA EL CULTIVO DE MATERIAL BOTÁNICO ACUÁTICO

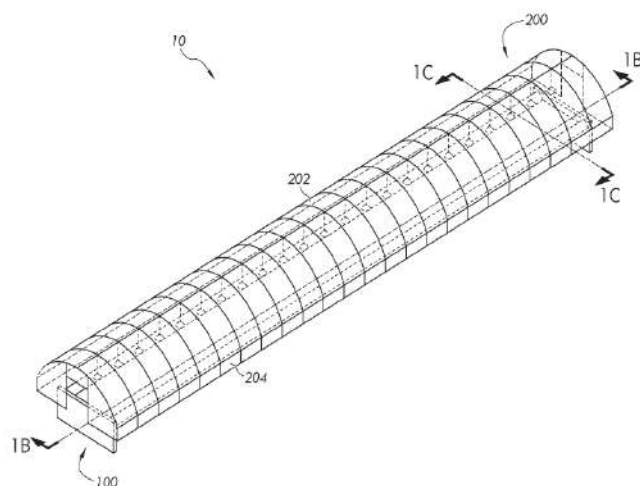

- (57) Resumen:** Un sistema para el cultivo de material botánico acuático que incluye una cuenca que define una longitud, una profundidad variable y un ancho, en donde el ancho tiene una forma de sección transversal sustancialmente parabólica.

(19) Dirección Nacional de la Propiedad Industrial – URUGUAY

(12) Invención

(11) UY a/040474

- (51) **Clasificación Internacional:** C 07D 401/14(2006.01), C 07D 471/12(2006.01), A 61K 31/4353(2006.01), A 61K 31/397(2006.01), A 61K 31/4523(2006.01), A 61P 35/00(2006.01) // A 61P 35/00
- (22) **Fecha de presentación:** 05/10/2023
- (30) **Datos de prioridad:** 63/413,548 05/10/2022 US
- (71) **Solicitante:** AMGEN INC. [US]
- (72) **Inventor:** Hui-Ling WANG [TW]; Jingjing XIE [CN]; Abhisek BANERJEE [IN]; David HUANG [US]; Patricia LOPEZ [US]; Francesco MANONI [IT]; Wenhan ZHANG [CN]; Nuria A. TAMAYO [US]; Matthew R. KALLER [US]; Brian A. LANMAN [US]; Adili ALAFATE [CN]; Emil GLIBSTRUP [DK]; Imelda HOT [ME]; Birgitte W. HUSEMOEN [DK]; Slavko RAST [HR]; Vu Van MA [US]
- (74) **Agente/apoderado:** FABIANA PENADES (216)
- (54) **Título:** INHIBIDORES HETEROCÍCLICOS ANCLADOS DE PROTEÍNAS KRAS G12C MUTANTES Y USOS DE ESTOS

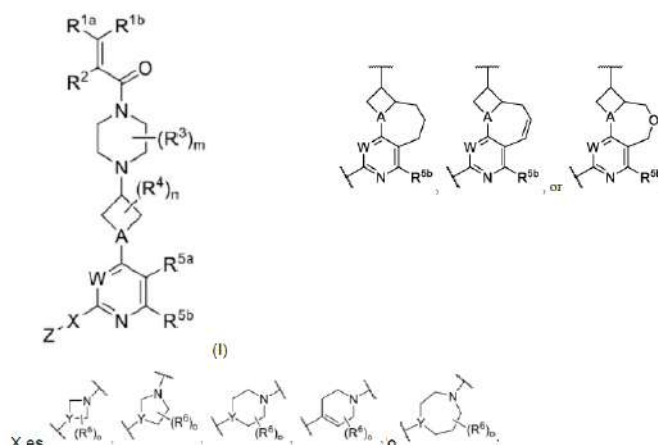

- (57) **Resumen:** La presente divulgación proporciona compuestos que tienen actividad inhibitoria sobre la proteína KRAS G12C mutante, composiciones farmacéuticas que comprenden los compuestos, y métodos para tratar determinados trastornos, como el cáncer, incluidos, a mero título enunciativo, cáncer de pulmón, cáncer de páncreas y cáncer colorrectal. En particular, la divulgación proporciona compuestos de Fórmula (II), y sales farmacéuticamente aceptables de estos, donde los sustituyentes son como se los describe.

(19) Dirección Nacional de la Propiedad Industrial – URUGUAY**(12) Invención****(11) UY a/040493**

- (51) Clasificación Internacional:** A 01H 5/10(2018.01)
(22) Fecha de presentación: 18/10/2023
(30) Datos de prioridad: 63/417,140 18/10/2022 US
(71) Solicitante: Cornell University [US]
(72) Inventor: Michael Thomas LOOS [US]; Masoume AMIRKHANI [US]; Antonio DITOMMASO [CA]; John Edward LOSEY [US]; Alan TAYLOR [US]
(74) Agente/apoderado: FABIANA PENADES (216)
(54) Título: COMPOSICIONES MOLDEADAS DE AGLOMERACIÓN DE SEMILLAS Y USOS DE LAS MISMAS

- (57) Resumen:** La invención divulga una composición que incluye a) dos o más semillas; b) un agente de relleno; y c) un agente aglutinante; en donde la composición está configurada como una forma de semilla, capaz de albergar 5 las dos o más semillas de a).

(19) Dirección Nacional de la Propiedad Industrial – URUGUAY**(12) Invención****(11) UY a/040512**

- (51) Clasificación Internacional:** C 07D 317/08(2006.01), C 07D 317/10(2006.01), C 07D 317/20(2006.01), C 07D 317/24(2006.01), C 10G 3/00(2006.01), C 10L 1/00(2006.01)
- (22) Fecha de presentación:** 03/11/2023
- (30) Datos de prioridad:** 22 205 278.9 03/11/2022 EP y 23 192 932.4 23/08/2023 EP
- (71) Solicitante:** REC Reliable Engineering Concepts GmbH [DE] y TECOSOL GmbH [DE]
- (72) Inventor:** Julian Türck [DE]; Ralf Türck [DE]; David Türck [DE]; Jens Utecht [DE]; Jürgen Krahl [DE]
- (74) Agente/apoderado:** Juana Bacot (245)
- (54) Título:** COMBUSTIBLE Y SU FABRICACIÓN

- (57) Resumen:** La presente invención proporciona combustibles para motores de combustión de tipo diésel y gasolina y, especialmente, combustibles que tienen un mayor contenido de componentes de combustible procedentes de fuentes renovables. En particular, se proporcionan combustibles de tipo diésel que contienen al menos solketal, combustible alcano renovable y biodiésel. También se proporcionan combustibles de gasolina, en donde el solketal se proporciona como sustituto de la gasolina fósil u otros componentes del combustible de gasolina. La presente invención proporciona, además, métodos para fabricar los combustibles de la invención, así como usos de ellos.

(19) Dirección Nacional de la Propiedad Industrial – URUGUAY**(12) Invención****(11) UY a/040530**

- (51) Clasificación Internacional:** B 01J 23/00(2006.01), B 01J 25/02(2006.01), C 07C 31/12(2006.01), C 07C 31/125(2006.01)
- (22) Fecha de presentación:** 21/11/2023
- (30) Datos de prioridad:** 22209145.6 23/11/2022 EP
- (71) Solicitante:** Terra Mater BV [BE]
- (72) Inventor:** Kapil Shyam LOKARE [IN]
- (74) Agente/apoderado:** GONZALO FERNÁNDEZ SECCO (34)
- (54) Título:** OLIGOMERIZACIÓN DE ALCOHOLES

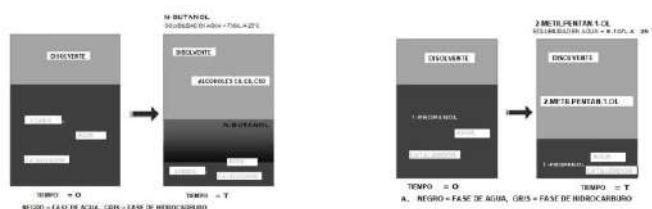

- (57) Resumen:** La invención se refiere a un proceso para convertir un alcohol C1-3 en alcoholes superiores, que comprende las etapas de: a. premezclar un alcohol C1-3, un catalizador y un sistema disolvente multicomponente, para formar una mezcla líquida; y b. calentar la mezcla líquida, obteniendo así alcoholes superiores. El sistema disolvente multicomponente comprende al menos una fase disolvente hidrocarbonada acuosa básica que comprende al menos dos hidrocarburos diferentes. El disolvente comprende una base seleccionada entre: hidróxido de potasio, hidróxido de sodio, etóxido de potasio, etóxido de sodio, t-butóxido de potasio, t-butóxido de sodio, o combinaciones de los mismos. El catalizador comprende un complejo de tipo $(HL)M(OH)_n (H_2O)_m$ y carbón activado.

SOLICITUDES DE DISEÑOS INDUSTRIALES

(19) Dirección Nacional de la Propiedad Industrial – URUGUAY

(12) Diseño Industrial

(11) UY s/005079

- (51) Clasificación Internacional:** 25-03
- (22) Fecha de presentación:** 29/03/2023
- (30) Datos de prioridad:**
- (71) Solicitante:** SCATEY S.A. [UY]
- (72) Inventor:** Rodrigo Cabral Sporta [UY]
- (74) Agente/apoderado:** VIRGINIA CERVIERI GHIOLDI (212)
- (54) Título:** PISCINA



- (57) Resumen:** El presente diseño industrial corresponde a una piscina, diferente de las conocidas, cuya apariencia original y ornamental le confieren características de individualidad.

(19) Dirección Nacional de la Propiedad Industrial – URUGUAY**(12) Diseño Industrial****(11) UY s/005080**

- (51) Clasificación Internacional:** 25-03
(22) Fecha de presentación: 29/03/2023
(30) Datos de prioridad:
(71) Solicitante: SCATEY S.A. [UY]
(72) Inventor: Rodrigo Cabral Sporta [UY]
(74) Agente/apoderado: VIRGINIA CERVIERI GHIOLDI (212)
(54) Título: PISCINA

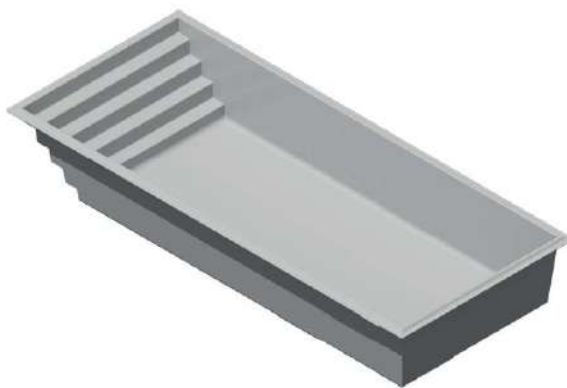

- (57) Resumen:** El presente diseño industrial corresponde a una piscina, diferente de las conocidas, cuya apariencia original y ornamental le confieren características de individualidad.

(19) Dirección Nacional de la Propiedad Industrial – URUGUAY**(12) Diseño Industrial****(11) UY s/005131**

- (51) **Clasificación Internacional:** 14-02
(22) **Fecha de presentación:** 06/09/2023
(30) **Datos de prioridad:** 29/886,191 06/03/2023 US
(71) **Solicitante:** Apple Inc. [US]
(72) **Inventor:** Jody AKANA [US]; Clara Geneviève Marine COURTAIGN [FR]; Bartley K. ANDRE [US]; Shota AOYAGI [JP]; Anthony Michael ASHCROFT [FR]; Marine C. BATAILLE [FR]; Jeremy BATAILLOU [FR]; Abidur Rahman CHOWDHURY [GB]; Markus DIEBEL [DE]; M. Evans HANKEY [US]; Julian HOENIG [AT]; Richard P. HOWARTH [GB]; Jonathan P. IVE [GB]; Julian JAEDE [DE]; Duncan Robert KERR [US]; Peter RUSSELL-CLARKE [AU]; Benjamin Andrew SHAFFER [US]; Joe Sung-Ho TAN [US]; Clement TISSANDIER [FR]; Eugene Antony WHANG [CA]; Jonathan GOMEZ GARCIA [GB]; Moises HERNANDEZ HERNANDEZ [MX]; Nicolas Pedro LYLYK [AR]; Marc A. NEWSON [GB]; Molly ANDERSON [GB]
(74) **Agente/apoderado:** FABIANA PENADES (216)
(54) **Título:** PANTALLA MONTADA EN LA CABEZA

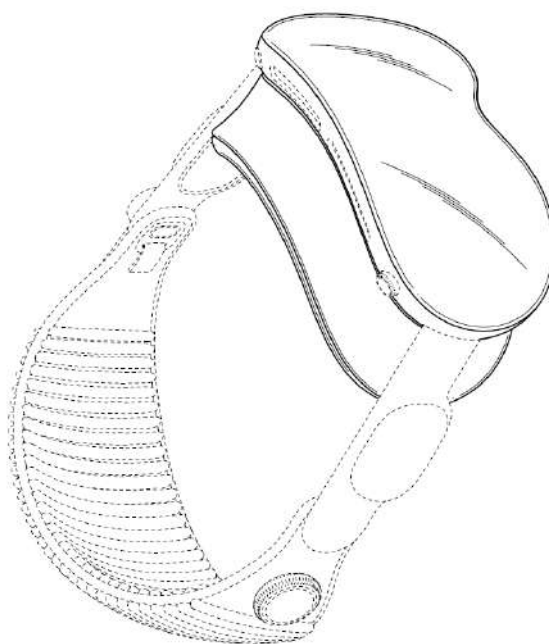

- (57) **Resumen:** Se divulga un nuevo diseño, original y ornamental para una PANTALLA MONTADA EN LA CABEZA, que puede usarse, por ejemplo, como un casco de realidad virtual, o una pantalla óptica colocada en la cabeza o lo similar.

(19) Dirección Nacional de la Propiedad Industrial – URUGUAY**(12) Diseño Industrial****(11) UY s/005144**

- (51)** Clasificación Internacional: 07-02
(22) Fecha de presentación: 03/10/2023
(30) Datos de prioridad: 015016913 04/04/2023 CH
(71) Solicitante: PRIMING AG [CH]
(72) Inventor: JOACHIM EPPER [CH]
(74) Agente/apoderado: MARTIN PITTALUGA PEREIRA (181)
(54) Título: MÁQUINA DE CAFÉ

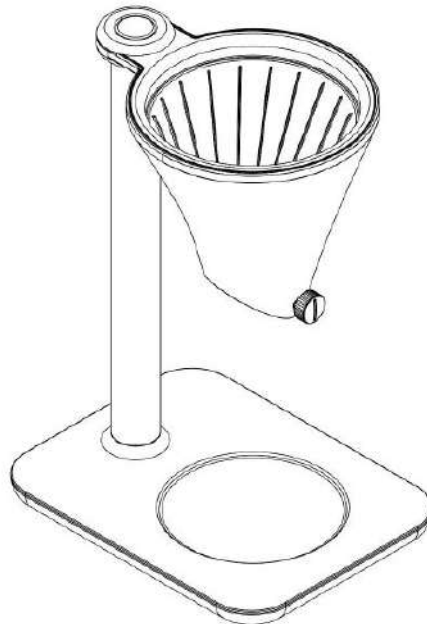

- (57)** Resumen: El presente diseño industrial se refiere al carácter ornamental de una máquina de café, tal como se describe e ilustra en los dibujos que se acompañan.

(19) Dirección Nacional de la Propiedad Industrial – URUGUAY**(12) Diseño Industrial****(11) UY s/005166**

- (51) Clasificación Internacional:** 12-08
(22) Fecha de presentación: 23/11/2023
(30) Datos de prioridad: 3-2023-01159 26/05/2023 VN
(71) Solicitante: Vinfast Trading and Production Joint Stock Company [VN]
(72) Inventor: Joao Marcos de Oliveira Ramos [BR]; Adam Ty Dean Smith [AU]; Justin James Thompson [AU]; Jae Hoon Lee [NZ]
(74) Agente/apoderado: Juan Eduardo Vanrell Falcon (144)
(54) Título: AUTOMÓVIL

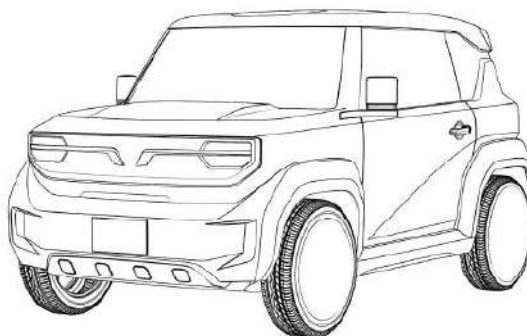

- (57) Resumen:** *

RESOLUCIÓN N° 05/2024

Montevideo, 12 de abril de 2024

RESOLUCIÓN N° 05/2024

VISTO: Las mejoras, actualizaciones y avances que se han implementado en los sistemas informáticos de la Dirección Nacional de la Propiedad Industrial, que permiten brindar los servicios a esta Unidad Ejecutora en formato digital.

RESULTANDO: I) Que dichas mejoras han permitido optimizar la gestión de los procesos en los sistemas informáticos, habilitando el acceso a la información a tiempo real para todos los usuarios de la propiedad industrial sin importar su ubicación geográfica.

II) Que la Oficina en su ordenamiento y funcionamiento interno debe acompañar estos avances permitiendo el mayor y pleno acceso a quienes quieran consultar los sistemas de la Dirección.

CONSIDERANDO: I) Que por la vocación de internacionalización de los intangibles industriales, la Base Pública de Marcas y Patentes de la Dirección Nacional de la Propiedad Industrial puede ser objeto de consulta en cualquier momento por personas interesadas ubicadas en zonas geográficas con husos horarios diferentes.

II) Que es política de esta Dirección fomentar la transparencia del sistema de propiedad industrial, y en particular, la apertura al mundo.

III) Que los avances anteriormente mencionados permiten tener los sistemas funcionando a plenitud durante toda la jornada, salvo situaciones puntuales para su mantenimiento o actualización.

ATENTO: A las competencias asignadas a esta Dirección en la materia y a la potestad del jerarca de reorganizar las funciones y tareas dentro del Servicio.

LA DIRECCIÓN NACIONAL DE LA PROPIEDAD INDUSTRIAL**RESUELVE:**

1º) ESTABLECER LA DISPONIBILIDAD de la Base Pública de Marcas y Patentes de la Dirección Nacional de la Propiedad Industrial para consulta por el público durante todos los días del año las 24 horas del día, salvo indisponibilidad transitoria por mantenimiento o situaciones puntuales que puedan originarse.

2º) ESTABLÉCESE que el mantenimiento y la actualización de los sistemas se realizará en forma diaria en el horario de 20 a 21:45 horas de Uruguay, franja horaria en la cual los mismos no estarán disponibles. Fuera de estos casos, la Dirección arbitrará las medidas necesarias para comunicar esa circunstancia a los usuarios.

3º) Por Secretaría, cúrsese copia de la presente a la Asociación de Agentes de la Propiedad industrial; notifíquese a Gestión de Sistemas de Información Sustantivos de esta Unidad Ejecutora, publíquese en la página web del Ministerio, publíquese en el Boletín de la Propiedad Industrial y oportunamente archívese.

ÍNDICE POR TITULARES DE MARCAS

Titular	N° Exp	Marca
ACOSTA, HUGO GERMAN	560987	KRATOS ACCESORIOS
Adalberto Juan FERREYRA URQUIZA	560846	URQUIZA (mixta)
ADAMA Makhteshim Ltd.	560652	RINDASO
ADAMA Makhteshim Ltd.	560653	BALAVOR
ADK Emotions Inc.	560507	BEYBLADE
Agustín Calvo	559389	Muy Humanos (mixta)
Agustin Nicolas Penino Delgado	561058	DisWid (mixta)
ALBERTO MARTIN SCASSO VOLONTE	560614	PUNTA DEL ESTE OPEN
ALDIESAN S.R.L.	560735	(figurativa)
ALDIESAN S.R.L.	560722	PERSONALIZATE (mixta)
ALDIESAN S.R.L.	560728	ALEGORIAS centro creativo (mixta)
ALDIESAN S.R.L.	560732	ALEGORIAS TALLER PARA LAS ARTES (mixta)
ALDIESAN S.R.L.	560716	LA CASA DEL ARTESANO Creatividad al alcance de su mano (mixta)
ALDIESAN S.R.L.	560721	ARTE EN CASA by La Casa del Artesano (mixta)
ALDIESAN S.R.L.	560725	La casa del Artesano (mixta)
ALEJANDRA LABRAGA	560245	TU MARCA, TU DIFERENCIA
Alpha Plus Group Ltd	560947	WP (mixta)
AMBIPAR PARTICIPAÇÕES E EMPREENDIMENTOS S.A.	561091	AMBIPAR ENVIRONMENT
ANA BOTTERO	560724	OPTICA VERMAS (mixta)
andrew de souza leal gonzalez	560958	INSUMED SAS
GERARDO MARTIN LLOBET MARTINEZ y ANGELICA CRISTINA MAYA AGUILAR	559383	LEGIONARIOS BOXING CLUB RESPETO HONOR & GLORIA URUGUAY L.A. (mixta)
Anhui Jianghuai Automobile Group Corp., Ltd.	560901	JAC (mixta)
Anixter-Real Estate, LLC	560817	XPRESSCONNECT
APITORIA PHARMA PRIVATE LIMITED	560978	APITORIA (mixta)
APPLE INC.	560960	App Store (mixta)
Applied Felts, Inc.	560787	AQUACURE
Applied Felts, Inc.	560799	NOVAPIPE
Applied Felts, Inc.	560806	GHOSTLINER
Applied Felts, Inc.	560789	ENVIROCURE
Applied Felts, Inc.	560801	ENVIROCURE UV
Applied Felts, Inc.	560793	MAX CALTUBE
ASFALKOTE PENNSYLVANIA S.A.	560629	MODULKOTE
ASOCIACION URUGUAYA DE ASADORES ASOCIACIÓN CIVIL	556347	AUA (ASOCIACIÓN URUGUAYA DE ASADORES) (mixta)
Atanzio Investimentos Eireli	554020	POPPYS FAST FOOD (mixta)
AUDAX QUIMICA INDUSTRIA E COMERCIO DE PRODUTOS PARA HIGIENE E LIMPEZA LTDA.	561214	AUDAX FACILITA
Augusto Cadenas	560713	ALUCRIL
AUSTRAL SOFTWARE DEVELOPMENT SAS	561085	e Report (mixta)
AUSTRAL SOFTWARE DEVELOPMENT SAS	561090	e Steering (mixta)
AUSTRAL SOFTWARE DEVELOPMENT SAS	561089	e Hub (mixta)
AUSTRAL SOFTWARE DEVELOPMENT SAS	561087	e Stream (mixta)

Titular	N° Exp	Marca
AUSTRAL SOFTWARE DEVELOPMENT SAS	561084	e Project (mixta)
AUSTRAL SOFTWARE DEVELOPMENT SAS	561023	e Plan (mixta)
AUSTRAL SOFTWARE DEVELOPMENT SAS	561022	e Perform (mixta)
AUSTRAL SOFTWARE DEVELOPMENT SAS	561010	E DASHBOARD (mixta)
AUSTRAL SOFTWARE DEVELOPMENT SAS	561016	e Collect (mixta)
AUSTRAL SOFTWARE DEVELOPMENT SAS	561019	e Library (mixta)
AUTOMOBILI LAMBORGHINI S.p.A.	561197	TEMERARIO
Ayelen Mayuncaldy Dragolovich	560295	LOS RUMBOS (mixta)
Banque Syz SA	560661	SYZ
BARRACA JORGE WALTER ERRO S.A.	561229	MINIMAX FERTILIZANTES MINI GRANULADOS (mixta)
Bayer Aktiengesellschaft	560640	WONDER
Bayer Aktiengesellschaft	560733	SUNHARBO
Bayer Aktiengesellschaft	560749	CORTENIC
Bayer Aktiengesellschaft	560743	YAPAZVY
BEATRIZ CARAMBULA	559428	PUNTO INMOBILIARIO (mixta)
Beiersdorf AG	560907	NIVEA CONNECT (mixta)
Beiersdorf AG	560838	CITRACELL-PROTECT
Block, Inc.	560737	\$CASHTAG
BLUE ORIGIN MANAGEMENT CONSULTANT PTE. LTD.	560962	OH!SOME (mixta)
BRITOS PEREIRA CARLOS Y ACOSTA GAMARRA LEIDY PAOLA SOCIEDAD DE HECHO	560121	THE KINGDOM PET SHOP (mixta)
BUDASOFF, FEDERICO ARIEL	561227	FUMACHÚ (mixta)
BUNTECH, TECNOLOGIA EM INSUMOS LTDA.	561063	buntech (mixta)
BUNTECH, TECNOLOGIA EM INSUMOS LTDA.	561146	THE BEST (mixta)
Camara Uruguaya de Semillas	560269	URUGUAY SEEDS (mixta)
Carolina Herrera Ltd	560790	LA BOMBA
Celltrion Holdings Co., Ltd.	561000	CELLTRION (mixta)
CENTRO DE INTERVENCIONISMO VASCULAR S A (CIVA SA)	560938	CIVASA
César Waldemar Eguren Figueroa	561207	MTS PRODUCTOS (mixta)
Chongqing Huayi Changshou Chemical Group Co., Ltd	560639	CHANGSHOU (mixta)
Martin Ortiz Villa; José María Díaz Couselo; Ana María Fuentes y Clara Carluccio	561045	LOS PEREGRINOS
Claudia Iris Mera Rodriguez	560954	Semioyoga
CONEXIÓN GANADERA LTDA.	561310	STRADIVARIUS (mixta)
Corelux S.R.L.	560218	ELEGANS
Corelux S.R.L.	560217	ABASUR ELEGANS (mixta)
Corteva Agriscience LLC	560650	UNIVOQ
Corteva Agriscience LLC	560607	INATREQ
COX ENERGY SOLAR, S.A.	560905	COX
CRAMON S.A.	560715	Smaken
CURIARA FINANCIAL SERVICES INC.	560750	CURIARA (mixta)
DACONAL S.A.	561168	VAKERO MODERN TOOLS FOR AGRO (mixta)
DE LEON ESQUIBEL FLORENCIA	561049	Ó ANTÓFILA (mixta)
DELLATERRA SAS	560544	RECETAS DEL SUR (mixta)
DIAMOND QUEST LIMITED	560868	SAAT
DIAMOND QUEST LIMITED	560869	BLUE RANGE

Titular	N° Exp	Marca
DIGITAL BEAT PTE. LTD.	560079	HOMATICS (mixta)
DIGITAL BEAT PTE. LTD.	560078	(figurativa)
DISTRIBUIDORA DEL POLO SAS	560708	CINNAMON INSOLES (mixta)
DISTRIBUIDORA DEL POLO SAS	560568	EURO KIDS
DISTRIBUIDORA DEL POLO SAS	560861	EUROCONFORT
Dufry International AG (Dufry International SA) (Dufry International Ltd)	560876	Hudson (mixta)
Dufry International AG (Dufry International SA) (Dufry International Ltd)	560874	DUFY (mixta)
Dufry International AG (Dufry International SA) (Dufry International Ltd)	560871	HMSHost (mixta)
Dufry International AG (Dufry International SA) (Dufry International Ltd)	560870	AUTOGRILL (mixta)
Dufry International AG (Dufry International SA) (Dufry International Ltd)	560643	AVOLTA (mixta)
Dufry International AG (Dufry International SA) (Dufry International Ltd)	560682	AVOLTA (mixta)
Dufry International AG (Dufry International SA) (Dufry International Ltd)	560888	ClubAvolta (mixta)
EAE ELEKTRIK ASANSÖR ENDÜSTRISI INSAAT SANAYI VE TICARET ANONIM SIRKETI	561096	EAE (mixta)
Ecolab USA Inc.	561098	ZEPHAIR
ECUATORIANA DE PRODUCTOS ELECTRONICOS S.A. IEPESA	560983	AMERICAN HOME ELEMENTOS SANITARIOS DE LARGA VIDA (mixta)
Emerald BioAgriculture Corp.	560249	AUXIGRO
EnTrans International, LLC	560430	E ENGINEERED TRANSPORTATION INTERNATIONAL (mixta)
EnTrans International, LLC	560429	ENTRANS
ENTRASTE SAS	560751	ENTRASTE
ESTEBAN AGUIRRE	560675	CAMALEÓN (mixta)
EUROFARMA URUGUAY S.A.	560969	KLEAR TOS
EUROFARMA URUGUAY S.A.	560932	VASCOR MR
EUROFARMA URUGUAY S.A.	560858	PRINOX
EUROFARMA URUGUAY S.A.	560970	KLEAR PLUS
FERNANDO DOÑO GOMEZ	560741	VERMOUTH CLU (mixta)
Fernando Johann	561042	Consiguelo Aqui
FGMM HOLDING COMPANY LLC	561205	FEMMTO HEALTHCARE (mixta)
florencia avellino	561120	galio brand
FONDO SOCIAL DE LA CONSTRUCCIÓN (ASOCIACION CIVIL)	561151	FONDO SOCIAL DE LA CONSTRUCCIÓN (mixta)
FONDO SOCIAL DE LA CONSTRUCCIÓN (ASOCIACION CIVIL)	561152	FONDO SOCIAL DE LA CONSTRUCCIÓN
FONDO SOCIAL DE LA CONSTRUCCIÓN (ASOCIACION CIVIL)	561154	FONDO SOCIAL DE LA CONSTRUCCIÓN UNA MANO SOLIDARIA (mixta)
FOODBOX SAS	560659	FOODBOX (mixta)
FOODOG COMPANY SAS	560123	FOODOG (mixta)
FUJIAN HONGXING ERKE SPORTS GOODS CO., LTD.	560971	ERKE (mixta)
GAC AION NEW ENERGY AUTOMOBILE CO., LTD.	560984	(figurativa)
GALEMEN S.A.	560115	ÉRETZ EXTRA VIRGIN OLIVE OIL

Titular	N° Exp	Marca
		(mixta)
Gaston Blanco	560645	PREMOLDEADOS DEL ESTE
Gaston Gamietea	560760	LOCOGIC (mixta)
Gerardo Andrés FUERTE TRIAS	559042	MUNDO MOVIL (mixta)
Gire S.A.	560656	rapipago (mixta)
GNOSIS S.p.A.	561066	QUATREFOLIC
GOAT LONDON CLOTHING LIMITED	560125	GOAT LONDON (mixta)
Golden Crop S.R.L.	559030	GOLDEN CROP (mixta)
GÓMEZ GERMANO, MARTÍN JAVIER	560525	TERRIER TM (mixta)
GOODWE TECHNOLOGIES CO., LTD.	560968	W (mixta)
GRUPO DELTRON S.A.	561170	TEROS LETS MOVE ON
Grupo Río de la Plata SAS	560899	LAS LILAS
HEAVEN HILL DISTILLERIES, INC.	561231	ELIJAH CRAIG
Hebei Tiger Tooth Machinery Parts Co., LTD	561031	TIGER TOOTH (mixta)
Heil Trailer International, LLC	560431	HEIL TRAILER
Heil Trailer International, LLC	560432	HEIL TRAILER (mixta)
Herbalife International, Inc.	560917	(figurativa)
Herbalife International, Inc.	560916	Herbalife (mixta)
HERMES INTERNATIONAL	560910	H (mixta)
Honor Device Co., Ltd.	560779	HONOR MAGIC V FLIP
Horacio Pascual	561273	A AUSTERA (mixta)
IGS ALUMINIO SOCIEDAD ANONIMA	561005	IGS (mixta)
INDUSTRIA DE DISEÑO TEXTIL S.A. (INDITEX S.A.)	561180	(figurativa)
INDÚSTRIA E COMÉRCIO SANTA MARIA LTDA	559417	SPLUM
INDÚSTRIA E COMÉRCIO SANTA MARIA LTDA	559418	CORPUS
INDUSTRIAL DELIGHTS S.A. (INDEL S.A.)	561183	BUENACHOS (mixta)
INGCO TOOLS CO., LIMITED	561291	HOJITA
Inspired Education Holdings Limited	561128	inspired (mixta)
Intel Corporation	561304	TIBER
Intel Corporation	561303	INTEL TIBER
INTERBLOCK D.O.O.	560863	ROULETTE FRENZY
INTERPARFUMS S.A.	561143	BAISER PLACE VENDÔME
INTERPARFUMS S.A.	561144	THÉ AU PALAIS ROYAL
ISLAMORADA SAS	560723	BALI HAI
JAVIER GONZALEZ LAWLOR	561253	ACQUABLU
JB IP, LLC	560949	JUNGLE BOYS
JBM Geio, S.L.	561067	JBM (mixta)
Jeannine LAGUARDIA	560747	DERMA LAB (mixta)
JNTL Consumer Health I (Switzerland) GmbH	561079	OGX (mixta)
José Alborés	560704	Vikings (mixta)
JUAN PABLO HELGUERA PEREIRA	559639	AGRO INVESTMENT URUGUAY (mixta)
JURATOYS	560510	JANOD
KAREN SOSA BALDOVINO y JOHANA CURBELO CUSTODIO	555425	QUEEN´S (mixta)
Kia Corporation	560866	SYROS (mixta)
KIMBERLY-CLARK WORLDWIDE, INC.	560981	POISE
KING MAKER MARKETING, INC.	561099	GRAYSONS
KING'S EDUCATION LIMITED	560826	KING´S COLLEGE SCHOOLS (mixta)
LABORATORIO LIBRA SOCIEDAD ANONIMA	560630	VASOPROT
LABORATORIOS DE PRODUCTOS ETICOS S.A.	560914	ETICOS (mixta)
LABORATORIOS DE PRODUCTOS ETICOS S.A.	560913	ETISONA

Titular	N° Exp	Marca
LABORATORIOS DE PRODUCTOS ETICOS S.A.	560909	TORALGIN
LABORATORIOS DE PRODUCTOS ETICOS S.A.	560912	LABORATORIO DE PRODUCTOS ETICOS CEISA
Laboratorios Stein, S.A.	560755	DATREXIA
Laboratorios Stein, S.A.	560993	UZTOK
L'AIR LIQUIDE, SOCIETE ANONYME POUR L'ETUDE ET L'EXPLOITATION DES PROCEDES GEORGES CLAUDE	561224	LASAL
L'AIR LIQUIDE, SOCIETE ANONYME POUR L'ETUDE ET L'EXPLOITATION DES PROCEDES GEORGES CLAUDE	561222	SMARTOP (mixta)
L'AIR LIQUIDE, SOCIETE ANONYME POUR L'ETUDE ET L'EXPLOITATION DES PROCEDES GEORGES CLAUDE	561218	PHARGALIS
L'AIR LIQUIDE, SOCIETE ANONYME POUR L'ETUDE ET L'EXPLOITATION DES PROCEDES GEORGES CLAUDE	561220	ECO ORIGIN (mixta)
L'AIR LIQUIDE, SOCIETE ANONYME POUR L'ETUDE ET L'EXPLOITATION DES PROCEDES GEORGES CLAUDE	561208	ALPHAGAZ
LEONARDO ENRIQUE SANGUINETTI PAIVA	560709	PROTAGONISTAS
Lila Magnone Dos Santos	561186	PORTOFINO (mixta)
Linde GmbH	560703	MAKING OUR WORLD MORE PRODUCTIVE LINDE (mixta)
L'Jolge Business Trading SAS	561052	KPro KAPÉ (mixta)
LONEMAR S.A.	561243	SOLERIOS
LOUIS DREYFUS TRADEMARKS B.V.	561145	MI LDC (mixta)
Luis Brambillasca	561169	UY CHOQUÉ (mixta)
Luis Ernesto Guerrero Domínguez	560065	PASTAS DOÑA TOTA TARARIRAS (mixta)
LUMINOVA PHARMA CORPORATION GmbH	561149	DEMEZILO
LUMINOVA PHARMA CORPORATION GmbH	561148	OMIPRE AMLO
LUXOTTICA GROUP S.P.A.	561034	(figurativa)
MABLE S.A.	561311	GRANNY (mixta)
Manantial de Azares S.A.S.	560821	EL NIDO BEACH & SURF HOMES (mixta)
Manantial de Azares S.A.S.	560825	EL NIDO BEACH & SURF HOMES (mixta)
MARKWINS BEAUTY BRANDS INTERNATIONAL Ltd.	561083	bonvoyage (mixta)
MARTINEZ, MARCOS	560922	E ELEQUIPO (mixta)
Mary Kay Inc.	561155	LASH LOVE FANORAMA
Maxliner LLC	560828	MAXLINER DURABLE PRODUCTS QUALITY MATERIALS (mixta)
Maxliner LLC	560824	MAXLINER
Maxliner LLC	560819	MAX LINERGUN
Maxliner LLC	560830	WOVOGLASS
Maxliner LLC	560831	WOVOLINER
Maxliner LLC	560832	WOVOX
Maxliner LLC	560816	LINERGUN
Maxliner LLC	560822	MAXLIGHT
Maxliner LLC	560820	MAX VERTIPOX
Maxliner LLC	560818	MAX FLEX 4D
MEDEROS RUIZ, MARY ESTHER	561258	TIENDA JAIME

Titular	N° Exp	Marca
M.Elsa Vargas y B. Olivera Vargas y Olivera	560632	Agua Batoví
MGA ENTERTAINMENT, INC.	561233	RAINBOW HIGH (mixta)
MICHEL NATALEVICH	560739	CR CAIRUO
MICRUS S.A.	561129	VINOS DEL MUNDO (mixta)
Midea Group Co., Ltd.	560606	ALL EASY (mixta)
MUSE CONCEPT	561054	muse (mixta)
Mustad Hoofcare S.A	561094	D (mixta)
Mylan Inc.	560673	VIATRIS (mixta)
Mylan Inc.	560674	VIATRIS (mixta)
Myrian Adriana De Los Santos Fernández	560957	PERRY 'S (mixta)
NARNAN S.R.L	561174	VITAL GYM (mixta)
nelson carrasco	561228	Odontotal (mixta)
NESK CALÇADOS LTDA	560730	NESK
NETAC TECHNOLOGY CO., LTD.	560603	NETAC (mixta)
NOLADRIL S.A.	561070	MONNET PAYMENT SOLUTIONS (mixta)
NOLADRIL S.A.	561071	MONNET PAYMENT SOLUTIONS (mixta)
NOLADRIL S.A.	561285	CL!NNG (mixta)
ODALER S.A.	561037	Géant (mixta)
OLD CHRISTIANS CLUB	560258	OLD CHRISTIANS CLUB
OLD CHRISTIANS CLUB	560265	OLD CHRISTIANS CLUB (mixta)
OLD CHRISTIANS CLUB	560262	(figurativa)
OTAIZA RODRIGUEZ BETIANA YOSELYN Y VIROGA BRACCO VICTORIA PAULA SOCIEDAD DE HECHO	558202	LEVID ENOCOSMÉTICA (mixta)
PABLO MIGUEL TROISE GOITIA	560955	YAMAYA (mixta)
PADARIA RECANTO COLONIAL LTDA.	561260	BISCOITOS RECANTO COLONIAL PRODUTO CASEIRO (mixta)
PANDA FIREWORKS GROUP CO., LTD.	560691	PANDA (mixta)
PAPPA, CARLOS ALBERTO	561046	T TOWER (mixta)
PASQUET GERSTLE, ANDRES	561189	MERCOPLUS LATAM
Pastificio Selmi S / A	560972	Todeschini
PEBEPE ASOCIADOS SRL	560974	BILLY BURGERS (mixta)
PESOS Y DOLARES SAS	561171	Pesos&Dólares (mixta)
PETKIN DIS TICARET LIMITED SIRKETI	560965	GEMAOIL (mixta)
PICHNIY VIERA NADIA MICAELA	559537	YOGUILOVER
PICHNIY VIERA NADIA MICAELA	559538	YOGUILOVER
PORTFOLIO CONCENTRATE SOLUTIONS UNLIMITED COMPANY	560662	7UP COCKTAILS
PREMIER REAL ESTATE SAS	561296	ISOPANELPRO (mixta)
PROMOTORA FARMACEUTICA SRL	560961	nutralab
PROMOTORA FARMACEUTICA SRL (También comercializada como PROMOFARMA SRL)	560473	NSSRY
PROMOTORA FARMACEUTICA SRL (También comercializada como PROMOFARMA SRL)	560472	Necessary Promofarma (mixta)
PROWINCH, LLC	560875	PROWINCH (mixta)
PUNKTAL S.A.	561047	PUNKTAL
Purenum GmbH	560836	MEDINIK (mixta)
REALCE ELETRODOMÉSTICOS LTDA	560924	REALCE (mixta)
Red Barn Holdings, Inc.	560668	FORTIFI FOOD PROCESSING SOLUTIONS (mixta)
Rodrigo Perlini	560681	grupo RPM training
ROLEX SA	561178	SUPERLATIVE CHRONOMETER

Titular	N° Exp	Marca
S.A. MOLINOS ARROCEROS NACIONALES (SAMAN)	561172	CHOCO CANICAS LA ABUNDANCIA
XOANA SOFIA CÁCERES y SABRINA AYLEN CÁCERES	560762	LAS LOCAS (mixta)
Salesforce, Inc.	560985	M MULESOFT (mixta)
SAMPER DIANO AMADEO	560520	SENYE (mixta)
SAMSUNG ELECTRONICS CO., LTD.	560865	DAILY BOARD (mixta)
SAUCONY, INC.	561234	(figurativa)
Scavone Hermanos S.A.	561077	TORALGIN
Scholl's Wellness Company LLC	559351	Dr.Scholl's (mixta)
SEB DO BRASIL PRODUTOS DOMESTICOS LTDA.	560837	ARNO (mixta)
SEB DO BRASIL PRODUTOS DOMESTICOS LTDA.	560753	LAVETE
SELLANES RODRIGUEZ GABRIELA BEATRIZ	560950	PIEDRAS PIEDRITAS (mixta)
SharkNinja Operating LLC	560770	SHARK
SHOULDER INDÚSTRIA E COMÉRCIO DE CONFECÇÕES LTDA	560613	SHOULDER (mixta)
Siegfried Rhein, S.A. de C.V.	560752	HYDRASHOT
SIGMA ALIMENTOS, S.A. DE C.V.	560348	SIGMA ALIMENTOS (mixta)
SIGMA ALIMENTOS, S.A. DE C.V.	560345	SIGMA (mixta)
SILVA BENIN STEPHANY GISSEL UNIPERSONAL	560996	MAKY
SK BIOPHARMACEUTICALS CO., LTD.	561232	XCOPRI
SK BIOPHARMACEUTICALS CO., LTD.	561251	ONTOZRY
SKY AIRLINE S.A.	561007	SKYPLUS
Sociedad Anónima Damm	560457	ESTRELLA DAMM BARCELONA 1876 1876 CERVEZA MEDITERRÁNEA 1876 AUGUST DAMM PREMIADA DE MALTA Y ARROZ 1876 100% INGREDIENTES NATURALES (mixta)
Société des Produits Nestlé S.A.	561053	G (mixta)
SOFTYS S.A.	561021	ULTRA ABSORCIÓN NOVA ULTRA MEGA ROLLO (mixta)
SOPHIA HOLDINGS, S.A. DE C.V.	560927	OSIS (OCULAR SURFACE INNOVATION SUMMIT)
SOSEI BIO SAS	560797	SOSEI REGENERANDO LA VIDA DEL SUELO (mixta)
SOSEI BIO SAS	560798	SALUD DEL SUELO
South Star Group International, Inc.	560986	SOUTH STAR
Space Exploration Technologies Corp.	561020	(figurativa)
SPACEDEV S.A.	560855	SPACE (mixta)
St. Dalfour International Incorporated	560727	JEAN FRANCOIS
STILER S.A.	558989	BLU bank landing URUGUAY (mixta)
SUPERMERCADOS DISCO DEL URUGUAY S.A.	560811	GDU (mixta)
SZABO S.A.	561024	FarmaPay (mixta)
Szabo S.A.	560791	CONCIENCIA POR LA VIDA
Szabo S.A.	560792	SERIM SIEGFRIED
Szabo S.A.	560795	COLPURIL SIEGFRIED
Szabo S.A.	560794	FLUVIX SIEGFRIED
TARGET GESTÃO DE MARCAS E PATENTES LTDA.	561082	[TKA] (mixta)

Titular	N° Exp	Marca
TA-TA S.A.	561086	MIS BENEFICIOS (mixta)
Taylor Made Golf Company, Inc.	560864	TAYLORMADE
Taylor Made Golf Company, Inc.	561026	T (mixta)
TBN LOGÍSTICA Y OPERACIONES PORTUARIAS S.A.S.	560786	LHG LOGISTICA Y OPERACIONES PORTUARIAS
TECNOAZUL SAS	560572	BIOENVASES (mixta)
TECNOPERFILES S.A.	560976	MUCHTEK (mixta)
TEROLD EUROPE S.L.	561238	FINCA LAS MORAS RED BLEND 2015 ARGENTINA (mixta)
TEROLD EUROPE S.L.	561239	LOS INTOCABLES OAK AGED BOURBON BARREL MALBEC 2020 FINCA LAS MORAS (mixta)
TEROLD EUROPE S.L.	561240	TRAPICHE GRAN MEDALLA MALBEC 2014 DESDE 1883 MENDOZA ARGENTINA (mixta)
TEROLD EUROPE S.L.	561236	ALMA MORA DE FINCA LAS MORAS MALBEC VENDIMIA 2022 (mixta)
TEROLD EUROPE S.L.	561237	SOUTH ATLANTIC WINES TRAPICHE COSTA & PAMPA CHARDONNAY 2014 CHAPADMALAL BUENOS AIRES (mixta)
Tesorería Sudamericana Sociedad Anónima	561203	WINERY7 (mixta)
The Gillette Company LLC	560130	Gillette (mixta)
The Gillette Company LLC	560129	(tridimensional)
THE POLO/LAUREN COMPANY, L.P	560720	AUSTRAL SANDALWOOD POLO EARTH RALPH LAUREN (mixta)
The Procter & Gamble Company	561003	BARREIRA ANTI-COCÔ
TICKET AGORA SERVIÇOS DE RESERVA, INTERMEDIACÃO E AGENCIAMENTO LTDA.	560989	TICKET SPORTS (mixta)
Tomra Systems ASA	560944	TOMRA T100
TOP2SELL SAS	560936	TOP2SELL (mixta)
TRAFIMET GROUP S.P.A.	560809	TRAFIMET (mixta)
TREPPCO S.A.S.	560943	Treppco (mixta)
TREPPCO S.A.S.	560945	Treppco (mixta)
TROFONI SRL	561018	PALTOLEA (mixta)
TUTEUR S.A.C.I.F.I.A.	560991	TISURAL
TUTEUR S.A.C.I.F.I.A.	560997	TREXONIL
ULBRIKA URUGUAYA S.A.	561142	DEKORIT
ULBRIKA URUGUAYA SOCIEDAD ANONIMA	560135	ULBRIKA MED (mixta)
UNILAM S.A	560443	PAPPOLINO (mixta)
UNILAM S.A.	560442	GUAPA! (mixta)
UNILAM S.A.	560441	PAPRIKA (mixta)
UNIQUE SHIELD SDN BHD	560745	SEVIOS
UNIQUE SHIELD SDN BHD	560746	SLEVIN
UNIQUE SHIELD SDN BHD	560748	IKLIM
INSTITUTO NACIONAL DE INVESTIGACION AGROPECUARIA (INIA) y UNIVERSIDAD DE LA REPUBLICA	560208	FAGRO ARMONIA
INSTITUTO NACIONAL DE INVESTIGACION AGROPECUARIA (INIA) y UNIVERSIDAD DE LA REPUBLICA	560204	MELBA
INSTITUTO NACIONAL DE INVESTIGACION AGROPECUARIA (INIA) y UNIVERSIDAD DE LA	560206	BRIXY

Titular	N° Exp	Marca
REPUBLICA		
INSTITUTO NACIONAL DE INVESTIGACION AGROPECUARIA (INIA) y UNIVERSIDAD DE LA REPUBLICA	560205	BÁMBOLA
UPL Mauritius Limited	560812	L-SPEC
URTADO MORALES DIEGO TABARE	560902	plasmado (mixta)
VITRINOR VITRIFICADOS DEL NORTE, S.A.L.	561315	VITRINOR (mixta)
WALRUS PUMP CO., LTD.	560658	WALRUS (mixta)
Walter Castro	560642	Correcaminos Uruguay (mixta)
Wolf Oil Corporation N.V.	559170	CHAMPION (mixta)
WTC FREE ZONE S.A.	560671	URBANO DELI (mixta)
YIWU DEARBODY COSMETICS CO., LTD.	560655	db BEAUTY (mixta)
YOMANI S.A.	560814	BEE.PET (mixta)
YU SHENGFENG	560657	PARIS NIGHT (mixta)
ZHEJIANG QIANTAO PUMPS CO., LTD.	561092	CHIMP (mixta)
ZITRO LABORATORY S.L.U.	560663	BILLY THE PIG (mixta)
226ERS SPORTS THINGS, S.L.	561072	226ERS

ÍNDICE POR TITULARES DE FRASES PUBLICITARIAS

Titular	N° Exp	Marca
ALDIESAN S.R.L.	560740	EL ARTE COMO HERRAMIENTA DE TRANSFORMACION DE NOSOTROS MISMOS
ALDIESAN S.R.L.	560738	CREATIVIDAD AL ALCANCE DE SU MANO
ESTEBAN AGUIRRE	560676	CAMALEÓN, PARA USAR SEGÚN LA OCASIÓN
ESTEBAN AGUIRRE	560677	CAMALEÓN, PARA COMPRAR O REGALAR, SEGÚN LA OCASIÓN
Grupo Bimbo, S.A.B. de C.V.	561125	NUTRE LO QUE AMAS
Jimena Peyrou	560634	El valor de la palabra
Nelson Carrasco	561235	PARA SONREIR CON CONFIANZA
SOFTYS S.A.	560726	Cuidamos el futuro hoy

ÍNDICE

LISTADO DE CÓDIGOS UTILIZADOS EN EL BOLETÍN	8
LISTADO DE AGENTES DE LA PROPIEDAD INDUSTRIAL.....	13
SOLICITUDES DE MARCAS Y OTROS SIGNOS.....	27
Marcas Solicitadas	27
Frasas Publicitarias Solicitadas.....	141
CONCESIONES DE MARCAS Y OTROS SIGNOS	144
Marcas Concedidas	144
Frasas Publicitarias Concedidas.....	156
DESISTIMIENTOS DE MARCAS Y OTROS SIGNOS.....	158
Marcas Desistidas (Art. 90 D. 34/999)	158
Renovaciones de Marcas Desistidas (Art. 90 D. 34/999)	158
DESESTIMACIONES DE MARCAS Y OTROS SIGNOS.....	160
Marcas Desestimadas.....	160
Marcas Desestimadas (Art. 92 D. 34/999).....	161
Renovaciones de Marcas Desestimadas (Art. 92 D. 34/999).....	161
Renovaciones de Marcas Desestimadas (Art. 92 D. 34/999).....	161
Marcas Tenidas por Desistidas (Art. 92 D. 34/999)	161
MODIFICACION DE RESOLUCIONES	162
Marcas con Resolución Modificada.....	162
Frasas Publicitarias con Resolución Modificada	162
NOTIFICACION DE RESOLUCIONES	163
CANCELACION POR FALTA DE USO DE MARCAS Y OTROS SIGNOS.....	165
Marcas Canceladas por Falta de Uso	165
Renovaciones de Marca Canceladas por Falta de Uso.....	165
RENOVACIONES DE MARCAS Y OTROS SIGNOS	166
Marcas Renovadas	166
Frasas Publicitarias Renovadas.....	209
TRANSFERENCIAS INSCRIPTAS	210
Transferencias de marcas, inscriptas.....	210
CAMBIOS DE NOMBRE INSCRIPTOS.....	217
Cambios de nombre de marcas, inscriptos.....	217
Cambios de nombre de patentes, inscriptos	224
CAMBIOS DE DOMICILIO INSCRIPTOS	225
Cambios de domicilio de marcas, inscriptos.....	225
Cambios de domicilio de frases publicitarias, inscriptos	238

Cambios de domicilio de patentes, inscriptos.....	238
EMBARGOS Y OTRAS PROHIBICIONES INSCRIPTOS	239
Prendas de marcas, inscriptas	239
RENUNCIAS INSCRIPTAS	251
Renuncias totales de marcas, inscriptas	251
Renuncias parciales de marcas, inscriptas	251
DESISTIMIENTOS	253
Notarial desistimientos	253
RESOLUCIONES DE RECURSOS Y REIVINDICACIONES	254
Resoluciones de marcas, revocadas por DNPI	254
CONCESIONES DE PATENTES.....	255
Patentes concedidas	255
Diseños industriales concedidos	255
DESESTIMACIONES Y ABANDONOS DE PATENTES	256
Patentes desestimadas	256
Patentes abandonadas	257
SOLICITUDES DE PATENTES DE INVENCION	259
SOLICITUDES DE DISEÑOS INDUSTRIALES	273
RESOLUCIÓN N° 05/2024.....	278
ÍNDICE POR TITULARES DE MARCAS	280
ÍNDICE POR TITULARES DE FRASES PUBLICITARIAS	289
ÍNDICE.....	290

Depósito legal 325.532

(N° 307)

Impreso en D.N.P.I.

E-mail: administracion.dnpi@miem.gub.uy

Rincón 719 Telefax 2840 1234

C.P. 11.000

Montevideo – Uruguay

Montevideo, 15 de abril de 2024



Ministerio
**de Industria,
Energía y Minería**

Dirección Nacional
de la Propiedad Industrial

